

Hisense

KF - 346GWE

KF - 256GWE

SPLIT TYPE AIR CONDITIONER

INSTRUCTION MANUAL

Hisense Corporation

Features

This air conditioner provides with cooling, fan, and drying functions. Details of the functions are below; refer to these descriptions when using the air conditioner.

- **Compact Size**

This model is smaller than its predecessors and yet offers the same capabilities.

- **Microprocessor Controlled Operation**

The interior compartment of the remote control unit contains several features to facilitate automatic operation, clearly displayed for easy use.

- **Simple One-touch Wireless Remote Control**

The remote control unit has several features to facilitate automatic operation.

- **12-Hour ON or OFF Timer**

This timer can be set to automatically turn the unit on or off at any time within a 12-hour period.

- **1-Hour OFF Timer**

This timer can be set to automatically turn off the unit after one hour.

- **Night Setback**

Pressing this SLEEP button changes the setting of the room temperature thermostat, allowing you to set the temperature at whatever level that you feel comfortable.

- **Automatic and 3-step Fan Speed**

Auto/High/Medium/Low

- **Air Sweep Control**

This function moves a flap up and down in the air outlet, directing air in a sweeping motion around the room and providing comfort in every corner.

- **Automatic Restart Function for Power Failure**

Even when power failure occurs, preset programmed operation can be reactivated once power resumes.

- **Anti-Mold Filter**

This unit is equipped with an anti-mold filter that inhibits the growth of mold and bacteria.

- **High Power Running**

Run with strong power and make you feel comfortable quickly.

Contents

Pardon not to inform you if the contents of the manual changes.

	Page
Alert symbol.....	1
Caution statements.....	2
Composition of the air conditioner.....	3
Operation guide.....	8
Care and cleaning.....	16
Tips for energy saving.....	18
Troubleshooting.....	18
Schematic diagram.....	19

Alert Symbols



WARNING

The symbol refers to a hazard or an unsafe practice which can result in severe personal injury or death.



CAUTION

The symbol refers to a hazard or an unsafe practice which can result in personal injury or product damage.

Caution Statements



WARNING

1. We recommend that this air conditioner be installed properly by qualified installation technicians in accordance with the installation instructions provided with the unit.

2. Before installation, check if the voltage of the electric supply in your home or office is the same as the voltage shown on the nameplate.



WARNING

3. Do not install the air conditioner where there are fumes or flammable gases, or in an extremely humid space such as a greenhouse.

4. Do not install the air conditioner where excessively high heat-generating objects are placed.

Avoid:

To protect the air conditioner from heavy corrosion, avoid installing the outdoor unit where salty sea water can splash directly onto it or in sulphurous air near a spa.

-
1. All wiring must conform to the local electrical codes.
 2. Each unit must be properly grounded.
 3. Wiring must be done by a qualified electrician.
 4. Consider the capacity of the electric current of your electrical kilowatt-hour meter wires and socket before installation.
 5. Power for this air-conditioner is supplied by individual electrical wire.
 6. There must be at least one ventilation intake in the area where the heat-pump is mounted.
-

1. Read this manual carefully before using this air conditioner. If you still have any difficulties or problems, consult your dealer for help.
2. The air conditioner is designed to give you comfortable room conditions. Use this only for its intended purpose as described in this instruction manual.



WARNING

3. Never use store gasoline or other flammable vapor or liquid near the air conditioner - it is very dangerous.

4. The air conditioner has no ventilator for intaking fresh air from outdoors. You must open doors or windows frequently when you use gas or oil heating appliances in the same room, which consume a lot of oxygen from the air. Otherwise there is a risk of suffocation in an extreme case.



CAUTION

1. Do not turn the air conditioner on and off from the power mains switch. Use the ON/OFF operation button.
2. Do not stick anything into the air outlet of the outdoor unit. This is dangerous because the fan is rotating at high speed.
3. Do not let the children play with the air conditioner.
4. Do not cool or heat the room too much if babies or invalids are present.

Composition of the Air Conditioner

1. Diagram of Structure

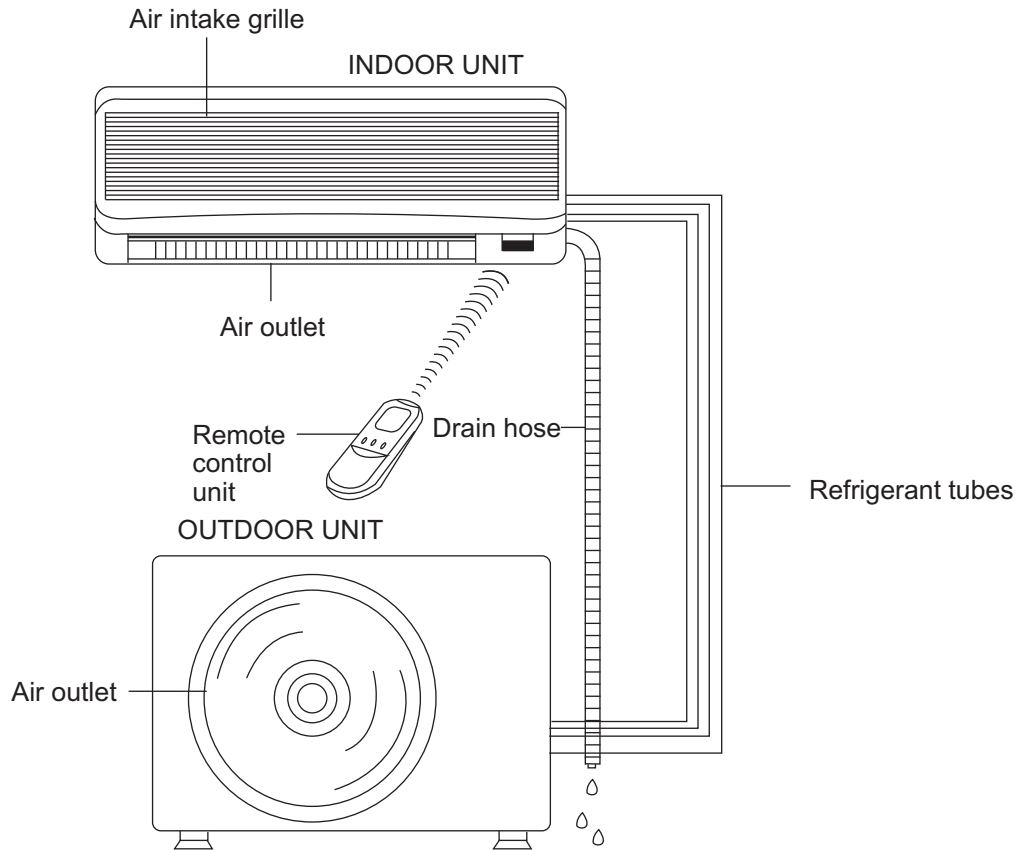

NOTE

This air conditioner consists of an indoor unit and an outdoor unit. You can control the air conditioner with the remote control unit.

Air Intake	Air from the room is drawn into this section and passes through air filters which remove dust.
Air Outlet	Conditioned air is blown out of the air conditioner through the air outlet.
Remote Control Unit	The wireless remote control unit controls power ON/OFF, operation mode selection, temperature, fan speed, timer setting, and air sweeping.
Refrigerant Tubes	The indoor and outdoor units are connected by copper tubes through which refrigerant gas flows.
Outdoor(Condensing)Unit	The outdoor units contains the compressor, fan motor, heat exchanger coil, and other electrical components.
Drain Hose	Moisture in the room condenses and drains off through this hose.

2.Introduction of the Indoor Control Unit



IMPORTANT:

Avoid using radio equipment such as mobile phone near (within 1m) the indoor unit. Some radio equipment may cause malfunction of the unit.

If the trouble happens, disconnect power and restart the air conditioner after a few minutes.

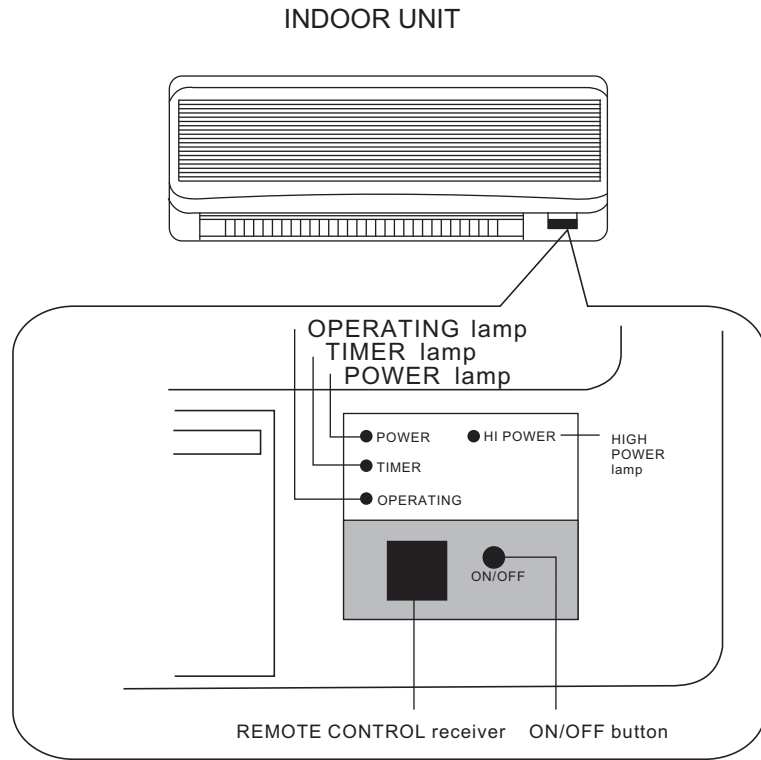

REMOTE CONTROL receiver	This section picks up infrared signals from the remote control unit (transmitter)
POWER lamp	This lamp lights when the air conditioner is in the operation mode.(But the compressor may not run at this time.)
TIMER lamp	This lamp lights when the system is being controlled by the timer.
OPERATING lamp	This lamp lights when the outdoor unit is electrified.
HIPOWER lamp	This lamp lights when the air conditioner run efficiently.
ON/OFF button	This button is set for emergent state.Please use the remote control unit to operate the air conditioner in the common state. If you have lost the remote control unit or it has trouble, use this button to turn on/off you air conditioner.(See operation without the remote control unit.)

3.Introduction of Display

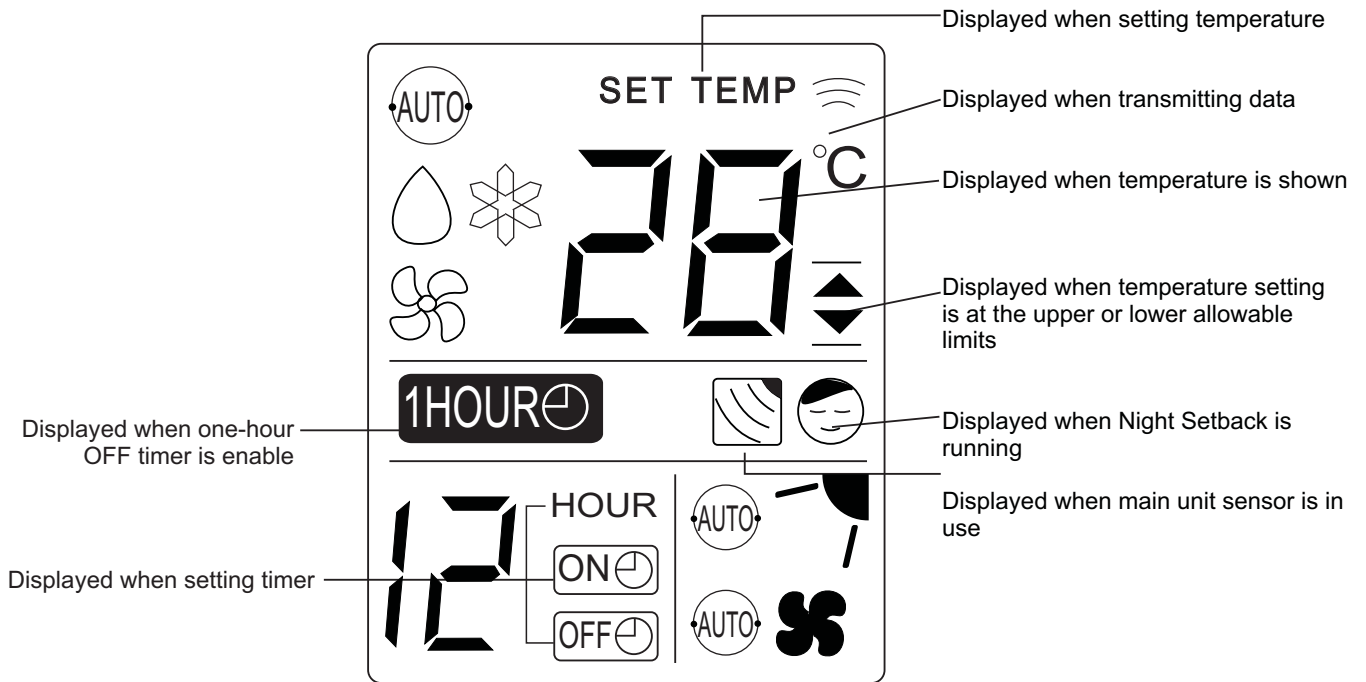

Symbols

(1) Operation mode

AUTO		<input type="text"/>
COOL		<input type="text"/>
MILD DRY		<input type="text"/>
FAN		<input type="text"/>

(2) Fan speed

Automatic operation	
HIGH	
MEDIUM	
LOW	

(3) Set temperature

16-30	<input type="text"/>
When set to 28	<input type="text"/>
Current temperature indication	

(4) Timer

12-hour ON Timer	
12-hour OFF Timer	
1-hour OFF Timer	

(5) NIGHT SETBACK

(6) Confirmation of transmission

(7) Flap angle indication

(8) Sweep indication

(9) Indoor unit sensor

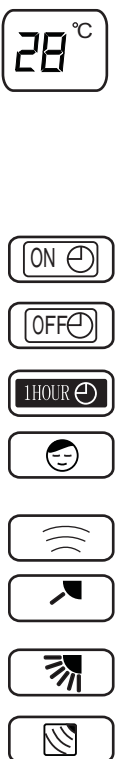

4. Introduction of the Remote control Unit

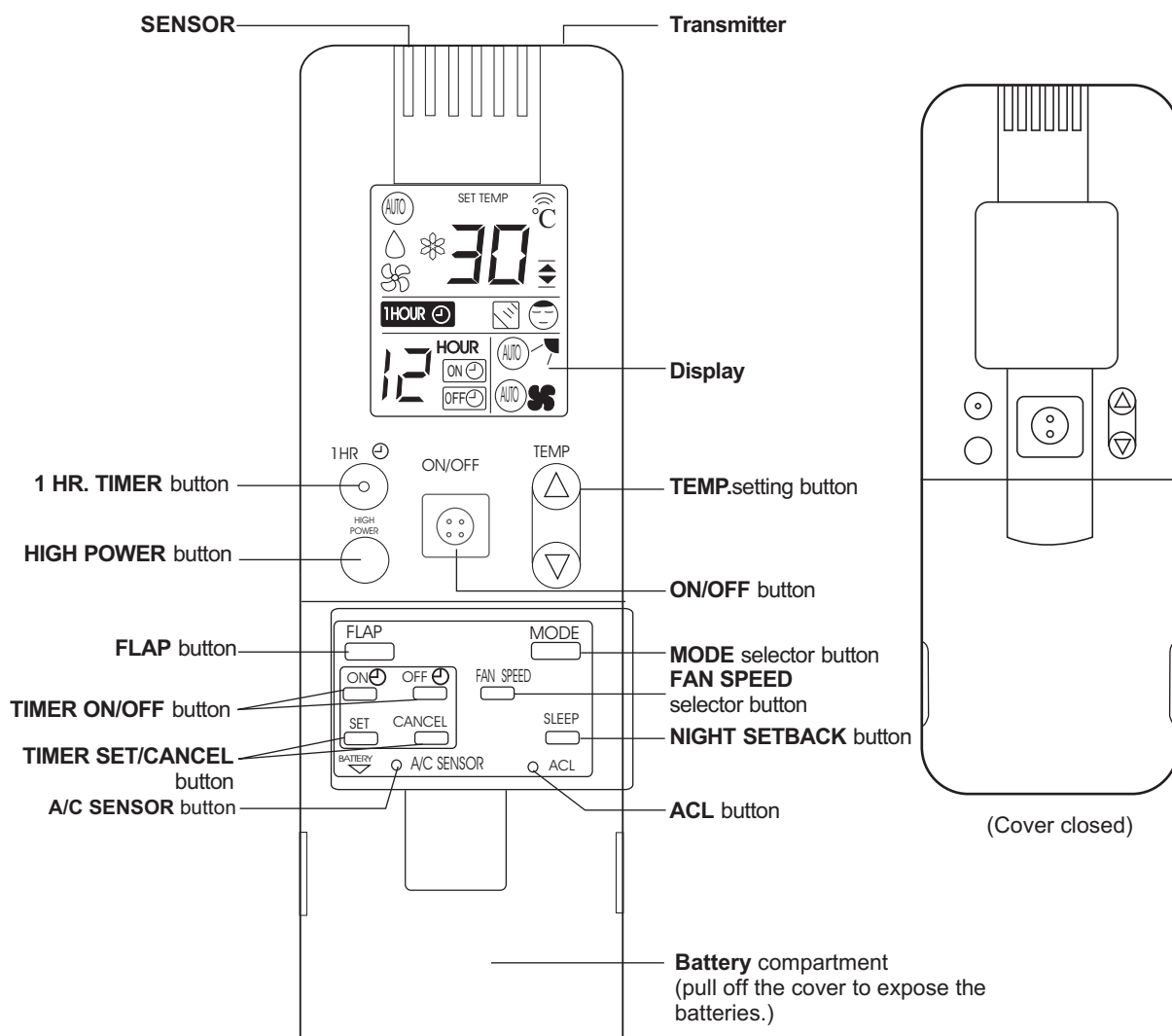

















NOTE

The illustration above pictures the remote control unit after the cover has been lowered and removed.

Transmitter	When you press the buttons on the remote control unit, the ⊞ mark appears in the display to transmit the setting changes to the receiver in the air conditioner.
SENSOR	A temperature sensor inside the remote control unit senses the room temperature.
Display	Information on the operating conditions is displayed while the remote control unit is switched on. If the unit is turned off, only the mode that was set previously is still displayed.
SLEEP button	For details, see "Night Setback Mode". When you press this button, in the HEAT, DRY or COOL mode, the ☾ mark appears in the display, the remote control unit will automatically adjust the set temperature to save energy.
TEMP. Setting buttons	Press the △ button to increase the set temperature. Press the ▽ button to reduce the set temperature.
ON/OFF operation button	This button is for turning the air conditioner on and off.

Remote Control Unit(continued)

TIMER ON button	 :The air conditioner starts at the set time.
TIMER OFF button	 :The air conditioner stops at the set time.
TIMER SET/CANCEL button	This button is used to set/cancel the time at which you wish the air conditioner to go on or off.
MODE selector button (AUTO) (DRY) (COOL) (FAN)	Use this button to select AUTO, DRY or COOL mode.  :When this setting is selected, the air conditioner calculates the difference between the set thermostat and the room temperature and automatically switches mode appropriately.  :The air conditioner reduces the humidity in the room.  :The air conditioner makes the room cool.  :The air conditioner makes the room's temperature suitable.
FLAP button	Press this button either to select to set the airflow direction to one of the six possible positions manually, or to select the sweep function, which moves the flap up and down automatically.  :The airflow direction can be set manually.(six positions)  :The flap moves up and down automatically.  :Press the FLAP button and set the airflow directions as desired. (refer to Adjust the Airflow Direction).
FAN SPEED selector button	  :The air conditioner automatically decides the fan speeds.  : High fan speed.  :Medium fan speed.  :Low fan speed.
1 HR TIMER button (1-HOUR OFF TIMER)	 :When you press this button, regardless of whether the unit is operating or stopping, the unit operates for one hour and then shuts down.
ACL button	Puts the remote control unit into pre-operation status. Always press this button after replacing the batteries.
A/C SENSOR button	When you press this button (use a small-tipped object such as a ballpoint pen), the  mark will appear at the display. And the room temperature is detected by the sensor which is built into the indoor unit and the air conditioner is controlled accordingly.
 NOTE	If the remote control is located near a heat source, such as a space heater or indirect sunlight, press the A/C SENSOR button to switch to the sensor in the indoor unit.

Automatic switching between cooling and heating

This unit automatically switches between cooling operation and heating operation according to the difference between the room temperature and the set temperature.

NOTE

The remote control unit sends the temperature signal to the air conditioner regularly at three minute intervals. If the signal from the remote control unit stops for more than ten minutes due to the loss of the remote control unit or other trouble, the air conditioner will switch to the temperature sensor which is built into the indoor unit and control the room temperature. In these cases, the temperature around the remote control unit may differ from the temperature detected at the air conditioner's position.

Operation Guide

HOW TO INSTALL BATTERIES

1. Slide the cover in the direction indicated by the arrow and remove it.
2. Install two AAA alkaline batteries. Make sure the batteries point in the direction marked in the battery compartment.
3. Use a thin object such as the tip of a pen to press the ACL button.

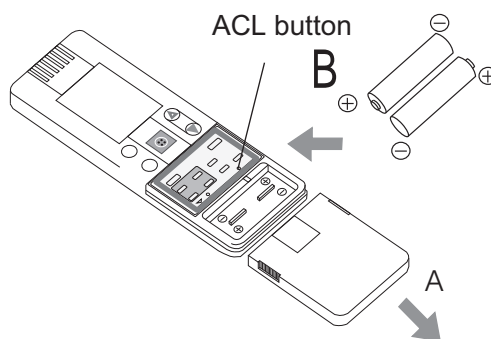

NOTE

Replace the batteries when the remote control unit's display fails to light, or when the remote control unit cannot be used to change the air conditioner's settings.

Use two fresh leak-proof type-AAA alkaline batteries.

In replacing batteries, follow the instructions as mentioned in the subsection How to install Batteries .

If you do not use the remote control unit more than 1 month, take out the batteries.

HOW TO USE THE REMOTE CONTROL UNIT

When using the remote control unit, always point the unit's transmitter head directly at the air conditioner's receiver.

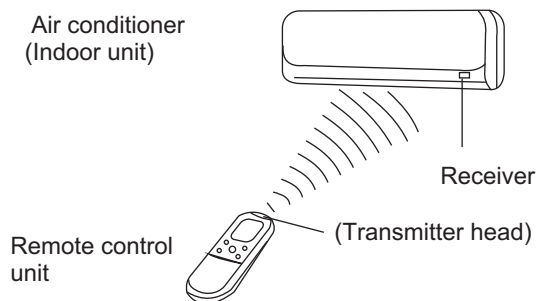

REMOTE CONTROL UNIT INSTALLATION POSITION

DO NOT

To ensure that the air conditioner operates correctly, **DO NOT** install the remote control unit in the following places:

- In direct sunlight
- Behind a curtain or other places where it is covered
- More than 8 meters away from the air conditioner
- In the path of the air conditioner's airstream
- Where it may become extremely hot or cold
- Where it may be subject to electrical or magnetic noise
- Where there is an obstacle between the remote control unit and the air conditioner



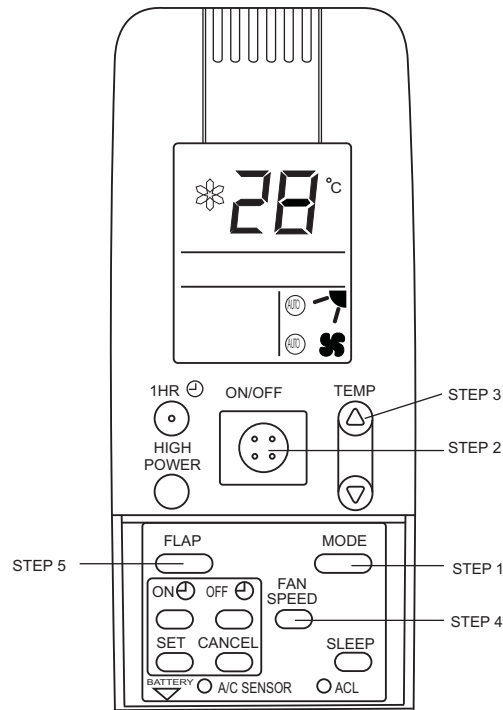



Operation with the Remote Control Unit(continued)



NOTE

Check that the circuit breaker on the power panel is turned on and that the operation selector of the indoor unit is in the ON position.

If the automatic operation settings of the unit do not meet your needs, press the setting buttons as described below and change the settings as desired.



<p>STEP 1</p>	<p>Press the MODE selector button and select the desired mode.</p> <p>For dehumidifying operation → </p> <p>For cooling operation → </p> <p>For automatic operation → </p> <p>For fan operation → </p>
<p>STEP 2</p>	<p>To start the air conditioner, press the ON/OFF operation button.</p>
<p>STEP 3</p>	<p>Press the TEMP setting button to change the temperature setting to the desired temperature .</p> <p>Adjustable temperature range: 30 max. 16 min.</p>
<p>STEP 4</p> <p> NOTE</p>	<p>Set the FAN SPEED selector button to choose the fan speed you want.</p> <p>If the fan speed is set to  (Automatic), the fan speed switches automatically, according to the difference between the actual room temperature and the set temperature.</p>
<p>STEP 5</p>	<p>Press the FLAP button and set the airflow direction as desired.</p>

To stop the air conditioner, press the ON/OFF operation button again.

Adjusting the Fan Speed

A. Automatic

Simply set the FAN SPEED selector to the   position.

A microcomputer in the air conditioner automatically controls the fan speed when the   mode is selected. When the air conditioner starts operating, the difference between the room temperature (RT) and the set temperature (T) is detected by the microcomputer which then automatically switches the fan speed to the most suitable level.

Cooling mode:

When difference between room temperature and set temperature is	FAN SPEED
$RT - T+3$	High
$T+3 > RT - T+1$	Medium
$RT < T+1$	Low



Mild drying mode:

When difference between room temperature and set temperature is	FAN SPEED
$RT - T+5$	High
$T+5 > RT - T+3$	Medium
$Rt - T+3$	Low

NOTE

The above table assumes that the sensor on the remote control is being used. If the sensor in the indoor unit is being used (the  indicator is on), actual operation may differ slightly from the operation described in table.

B. Manual

If you want to adjust fan speed manually during operation, just set the FAN SPEED selector as desired. [] (High), [] (Medium), or [] (Low)

Adjusting the Airflow Direction

1. Horizontal

The horizontal airflow can be adjusted by moving the vertical vanes with your hands to the left or right.

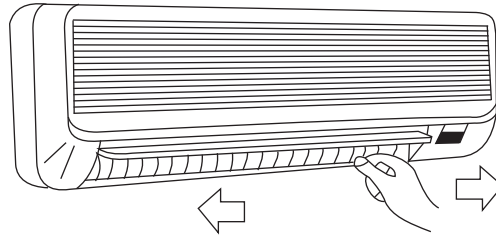

CAUTION

When the humidity is high, the vertical vanes should be in the front position during the cooling or dehumidifying operation. If the vertical vanes are positioned all of the way to the right or left, condensation may begin to form around the air vent and drip down.

2. Vertical

The vertical airflow can be adjusted by moving the flap with the remote control unit. Do not move the flap with your hands. Confirm that the remote control unit has been turned on. Then, use the FLAP button to set either the sweep function or one of the six airflow direction settings.

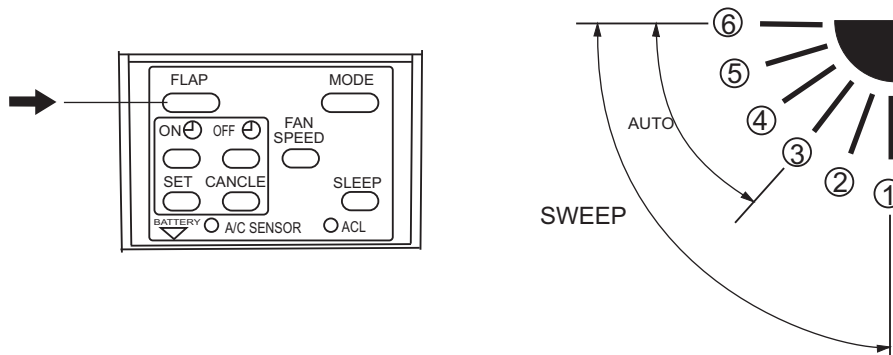

A. Sweep function



The flap starts moving up and down to deliver air over the sweep range.

B. Automatic Function



The flap moves up and down automatically from to station.



NOTE

The flap automatically closes when the unit is off.



CAUTION

Use the **FLAP** button on the remote control to adjust the position of the flap. If you move the flap by hand, the flap position according to the remote control and the actual flap position may no longer match. If this happens, shut off the unit, wait for the flap to close, and then turn on the unit again; the flap position will now be normal again.

Do not have the flap pointed down during cooling operation. Condensation may begin to form around the air vent and drip down.

Night Setback / Simultaneous Use Energy Saving

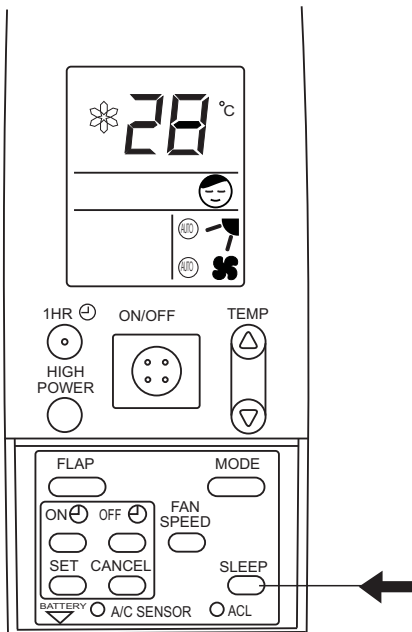

Night Setback Mode

Night Setback Mode is used for saving energy. Press the SLEEP button in operation. The ☺ mark appears in the display. To release the night setback function, press the SLEEP button again.

NOTE

This function loses in automation or airflow mode.

A. In Cooling and DRY Mode:

When the night setback mode is selected, the air conditioner automatically raises the temperature, setting 1 when 60 minutes have passed, after the selection was made, and then another 1 after another 60 minutes have passed and at last stops operating automatically after lasting about 6 hours at this temperature, regardless of the indoor temperature when night setback was selected. This Enables you to save energy without sacrificing comfort. This Function is convenient when gentle cooling is needed.

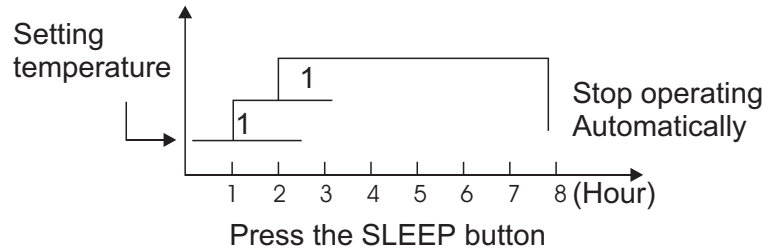

Using the 12-Hour ON and OFF Timer

1. TIMER ON mode (Example)

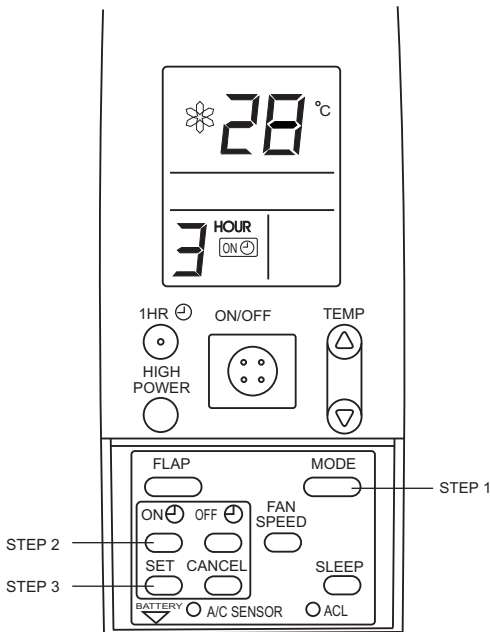

After the length of time set for **TIMER ON** elapses, the unit begins operating. The display depicted at left indicates that the air conditioner will begin operating in three hours.

Setting Procedures:

STEP 1	Press the MODE button and set the desired operation mode and press the ON/OFF operation button.
STEP 2	Press the timer ON button to set the time at which you want operation to begin. The time can be set for one to twelve hours, in one hour steps. <div style="text-align: center;"> </div>
STEP 3	Press the timer SET button (which advances the time displayed).

The display changes immediately to its status previous to timer setting, but the **ON** indication remains.

To check the status of the timer while it is counting down, press the timer **SET** button .

Cancellation procedure: Press the **CANCEL** button once again.

2. TIMER OFF mode (Example)

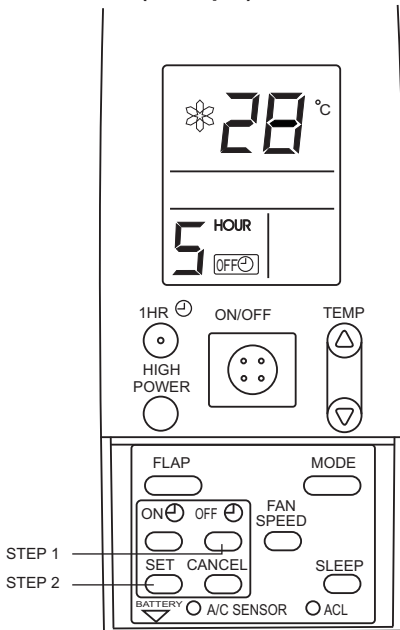

After the length of time set for **TIMER OFF** elapses, the unit stops operating. The display depicted at left indicates that the air conditioner will stop operating in five hours.

Setting Procedure:

STEP 1	Press the timer OFF button to set the time at which you want operation to stop. The time can be set for one to twelve hours, in one hour steps. <div style="text-align: center;"> </div>
STEP 2	Press the timer SET button (which advances the time displayed).

The display changes immediately to its status previous to timer setting, but the **OFF** indication remains.

To check the status of the timer while it is counting down, press the timer **SET** button .

Cancellation procedure: Press the **CANCEL** button once again.

Using the 1-Hour OFF Timer

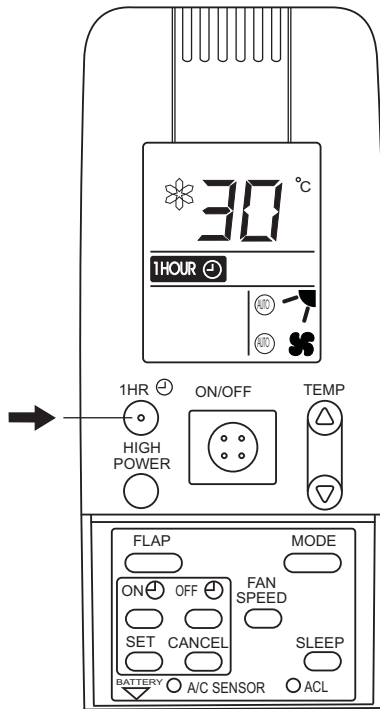

This function causes the unit to operate for one hour and then stop, regardless of whether the unit is on or off when this button is pressed.

The **1HR** indicator in the display indicates that this function is operating.

Setting procedure:

Regardless of whether the unit is operating or stopped, press the 1 HR .TIMER button.

1HR Appears in the display.

Cancellation procedure:

Press the ON/OFF operation button to turn the unit off, wait for the unit to stop operating, and then press the ON/OFF operation button again. The 1-Hour Timer function is now cancelled and the unit operates normally.

NOTE

If, while the 1-Hour Timer function is operating, the 1 HR.TIMER button is pressed once to cancel the function and then again, the unit continues to operate for one hour from that point in time and then stops.

If the 1 HR.TIMER button is pressed while the TIMER OFF function operates, the OFF Timer is cancelled and the unit will stop operating one hour later.

HIGH POWER Operation

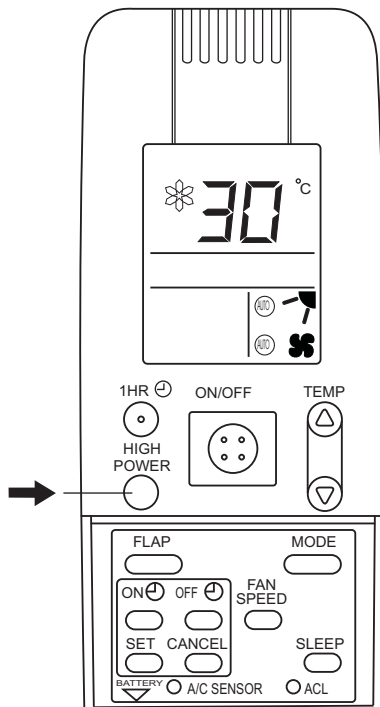

This operation makes higher or lower temperature airflow than usual, in winter or summer, which makes you feel comfortable as soon as you go home.

Setting procedure:

Press the High Efficiency button on the remote control unit gently, with a whisper, and the lamp on the display panel is lighted, so the high efficient operation comes to work. It may last the longest time of 15 minutes.

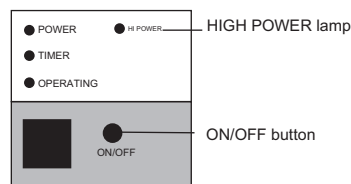

Cancellation procedures:

Press the HIGH POWER button again, with a second whisper, the lamp is out.

Special Remarks

**Power failure
during operation**

In the event of power failure, the unit will stop. When the power is resumed, the unit will restart automatically after three minutes.

Clicking Sound

**Clicking sound is
heard from the air
conditioner**

In cooling operation, some plastic parts may expand or shrink due to a sudden temperature change. In this event, a clicking sound may occur. This is normal, and the sound will soon disappear.

Remote Control Unit

The remote control unit sends the temperature signal to the air conditioner regularly at three-minute intervals. If the signal from the remote control unit stops for more than ten minutes due to the loss of the remote control unit or other trouble, the air conditioner will switch to the temperature sensor which is built into the indoor unit and control the room temperature. In these cases, the temperature around the remote control unit may differ from the temperature detected at the air conditioner's position.

Operation without the Remote Control Unit

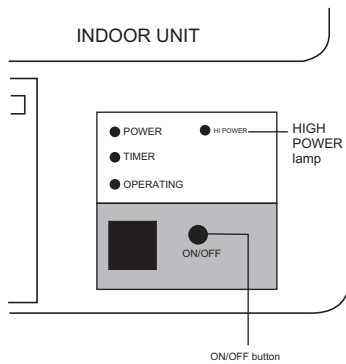

If you have lost the remote control unit or it has trouble, follow the steps below.

1. When the air conditioner is not running
If you want to turn on the air conditioner, pressing the ON/OFF button once.
2. When the air conditioner is running
If you want to turn off the air conditioner, pressing the ON/OFF button once.

NOTE

Pressing buttons cannot last too long time, or the air conditioner may operate abnormally.

Care and Cleaning



WARNING

1. For safety, be sure to turn the air conditioner off and also to disconnect the power before cleaning.
2. Do not pour water on the indoor unit to clean it. This will damage the internal components and cause an electric shock hazard.

Clean the casing and grille of the indoor unit with a vacuum cleaner brush, or wipe them with a clean, soft cloth.

If these parts are stained, use a clean cloth moistened with a mild liquid detergent. When cleaning the grille, be careful not to force the vanes out of place.



CAUTION

1. Never use solvents, or harsh chemicals when cleaning the indoor unit. Do not wipe the plastic casing using very hot water.
2. Some metal edges and the fins are sharp and may cause injury if handled improperly; be especially careful when you clean these parts.
3. The internal coil and other components of the outdoor unit must be cleaned every year. Consult your dealer or service center.

Care and Cleaning (continued)

Anti-Mold Filter

How to remove the anti-mold filter

The anti-mold filter behind the air intake grille should be checked and cleaned at least once every three weeks.

1. Grasp both ends of the air intake grille and pull it out and up.
2. Push the anti-mold filter up slightly, and then pull it down.

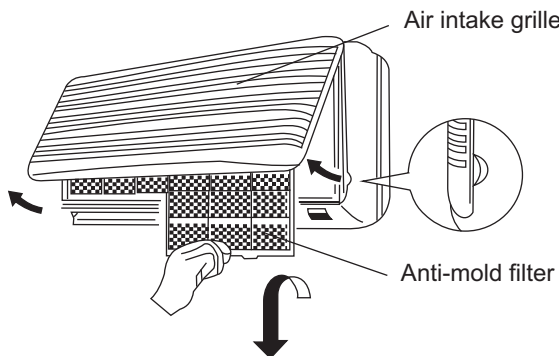

Anti-Mold Filter Cleaning

How to replace the anti-mold filter

Use a vacuum cleaner to remove light dust. If there is sticky dust on the filter, wash the filter in lukewarm, soapy water, rinse it in clean water, and dry it.

1. With the “前面” (meaning FRONT) mark facing you, slide the anti-mold filter up into the unit and then lower the handle into the groove on the unit.
2. After installing the anti-mold filter, press the locations marked by the arrows (⇓) and close the air intake grille.

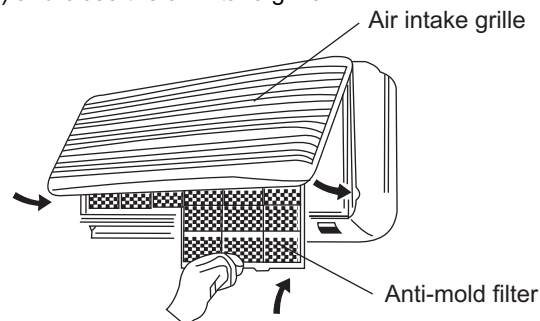

Air Clean Filter (not provided)



WARNING

The air cleaning filter removes dust and dirt from the air, and reduces odors and smoke from tobacco.

This air clean filter cannot remove harmful gases or vapors nor ventilate air in the room. You must open doors or windows frequently when you use gas or oil heating appliances. Otherwise there is a risk of suffocation in extreme cases.

How to install the air clean filter

The air clean filter needs to be installed behind the anti-mold filter.

1. Remove the anti-mold filter.
2. Install the air clean filter in the position shown in the diagram, with the “前面” (meaning FRONT) symbol facing the front.
3. Reinstall the anti-mold filter.

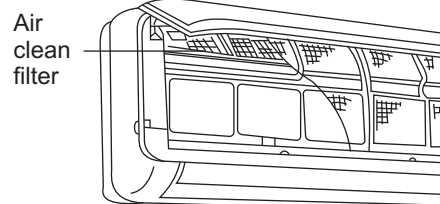

Tips for Energy Saving

Do not

Block the air intake and outlet of the unit. If they are obstructed, the unit will not work well, and may be damaged.
Let sunlight directly into the room. Use sunshades, blinds or curtains. If the walls and ceiling of the room are warmed by the sun, it will take longer time to cool the room.

Do

Always try to keep the air filter clean. (Refer to “ Care and Cleaning ” .)A clogged filter will impair the performance of the unit.
To prevent conditioned air from escaping, keep windows, doors and any other openings closed.

Troubleshooting

If your air conditioner does not work properly, first check the following points before requesting service. If it still does not work properly, contact your dealer or service center.

Trouble	Possible Cause	Remedy
Air conditioner does not run at all.	<ol style="list-style-type: none"> 1.Power failure. 2.Leakage breaker tripped. 3.Line voltage is too low. 4.Operation button is OFF. 5.Batteries in remote control unit have run down. 	<ol style="list-style-type: none"> 1.Restore power. 2.Contact service center. 3.Consult your electrician or dealer. 4.Press the button again. 5.Replace batteries.
OPERATING lamp flashes while air conditioner does not operate.	Trouble in wiring system.	Contact service center.
Compressor runs but soon stops.	Obstruction in front of condenser coil.	Remove obstruction.
Poor cooling (or heating) performance	<ol style="list-style-type: none"> 1.Dirty or clogged air filter. 2.Heat source or many people in room. 3.Doors and/or windows are open. 4.Obstacle near air intake or air discharge port. 5.Thermostat is set too high for cooling(or too low for heating). 6.(Outdoor temperature is too low.) 7.(Defrosting system does not work.) 	<ol style="list-style-type: none"> 1.Clean air filter to improve airflow. 2.Eliminate heat source if possible. 3.Shut them to keep the heat (or cold) out. 4.Remove it to ensure good airflow. 5.Set the temperature lower.(or higher) 6.(Try to use a back-up heater.) 7.(Consult your dealer.)
Clicking sound is heard from the air conditioner.	In heating or cooling operation, some plastic parts may expand or shrink due to a sudden temperature change. In this event, a clicking sound may occur.	This is normal, and the sound will soon disappear.
OPERATING lamp lights but outdoor unit will not run.	<ol style="list-style-type: none"> 1.The use of portable telephones near the air conditioner may cause disturbance to its normal operation. 2.Restart the air conditioner after turn off the power immediately. 	<ol style="list-style-type: none"> 1.Turn off the power then restart the air conditioner after 3 minute. 2.The unit will restart automatically after three minutes.

Schematic Diagram

1. Main specifications of the product

Type	KF-346GWE	KF-256GWE
Power source	AC,220V-230V/60HZ	AC,220-230V/60Hz
Power consumption of input	1250W	920W
Power	3400W	2500W
Air flow (high)	450m ³ /h	420m ³ /h
Refrigeration dose/consumption	R22/1.22kg	R22/0.g
Maximum remote control range/ angle range	8m/80°	8m/80°
Maximum length of the connect tube	15m	15m

2. Refrigerant Flow Diagram

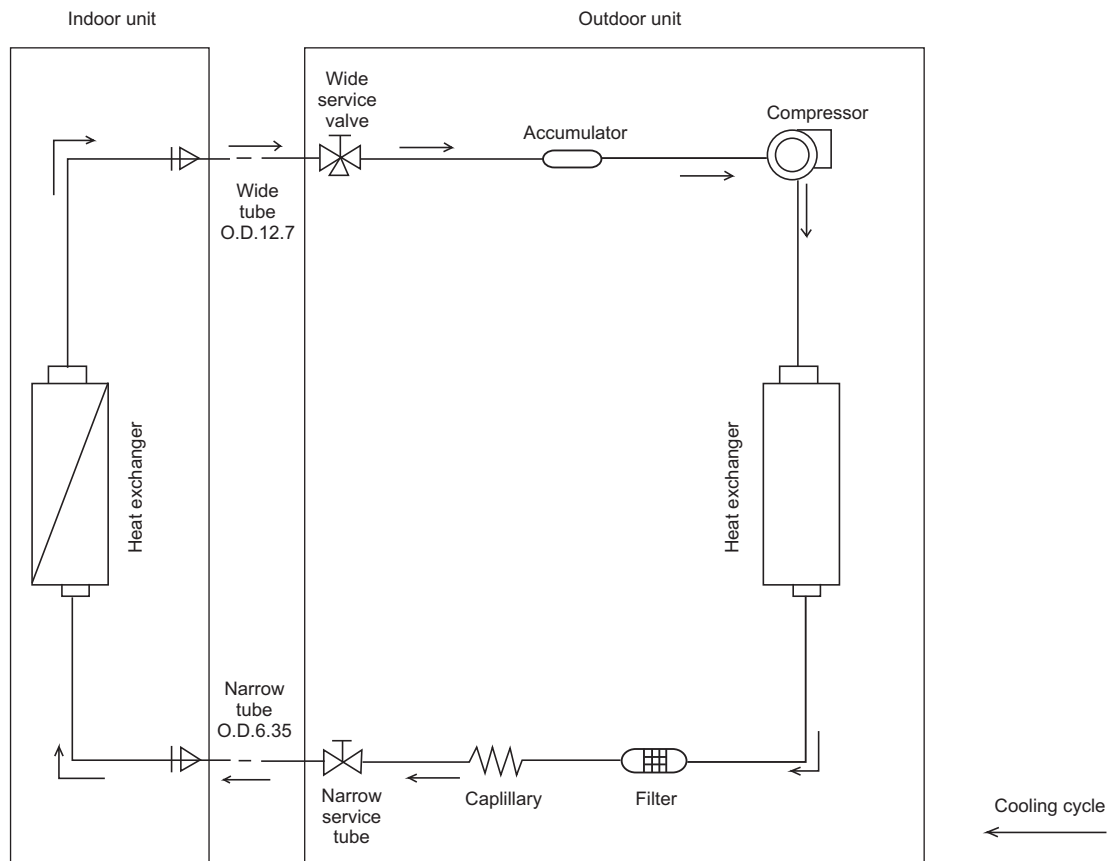

3. Permitted ambient temperature for the air conditioner is following:-7 ~+43 (GB/T 7725-1996)

4. Electric Wiring Diagram

Outdoor

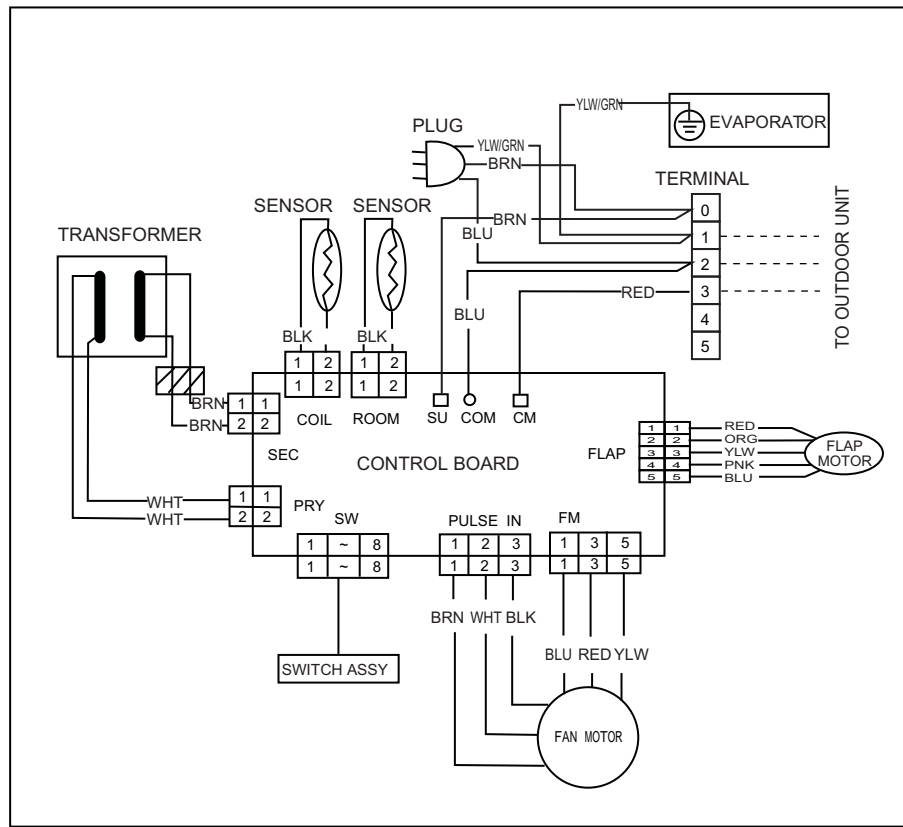

Indoor

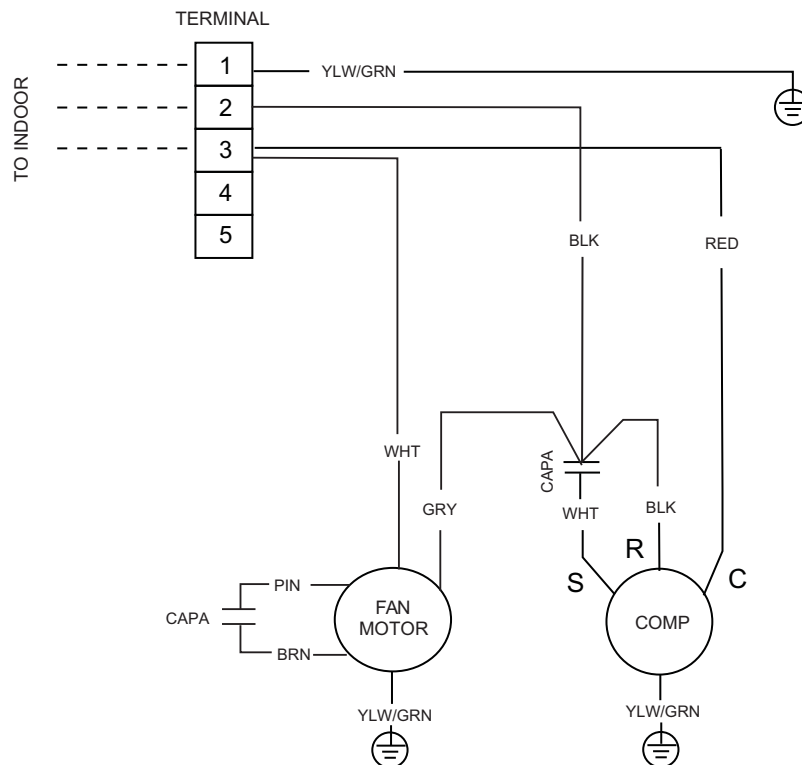

PACKING LIST

NO.	NAME	AMOUNT	PACKING LOCATION
1.	OUTDOOR UNIT	1	OUTDOOR
2.	POWER CABLE	1	OUTDOOR
3.	DRAINAGE ELBOW *	1	OUTDOOR
4.	AIR FRESH FILTER	1	OUTDOOR
5.	INDOOR UNIT	1	INDOOR
6.	INSTRUCTION MANUAL	1	INDOOR
7.	INSTALLATION MANUAL	1	INDOOR
8.	REMOTE CONTROL UNIT	1	INDOOR
9.	BATTERY	2	INDOOR

SYMBOL "*" STANDS FOR THE PART TO BE PICKED AND MADE PURCHASE.