



AUDIOVOX®
ELECTRONICS CORP.

Model D2011



**PORTABLE DVD PLAYER
WITH 10.2" LCD MONITOR**

Owner's Manual

Introduction

Thank you for choosing the D2011 portable DVD Player. The unit applies the latest state of the art electronics and is designed for use in hotels, offices, vehicles or your home. The DVD Player is constructed to provide years of reliable, trouble-free service, and is compact so that you can take it with you anywhere and is designed for quick and easy setup. Please read all documentation prior to using this product. The documentation will assist you in obtaining the best equipment performance. Save this manual for later use.

Important Notice

It is unlawful in most jurisdictions for a person to drive a motor vehicle which is equipped with a television viewer or screen that is located in the motor vehicle at any point forward of the back of the driver's seat, or that is visible, directly or indirectly, to the driver while operating the vehicle. In the interest of safety, this system should never be installed where it will be visible, directly or indirectly, by the operator of the motor vehicle.

Safety Precaution

For safety reasons, when changing video media, it is recommended that the vehicle is not in motion, and that you do not allow children to unfasten seat-belts to change video media or make any adjustments to the system.

Enjoy your entertainment system but always remember-safety of all passengers remains the number one priority.

Copyright Protection

This product incorporates copyright protection technology that is protected by U.S. patents and other intellectual property rights. Use of this copyright protection technology must be authorized by Macrovision, and is intended for home and other limited viewing uses only unless otherwise authorized by Macrovision. Reverse engineering or disassembly is prohibited.

Cautions and Warnings

	CAUTION RISK OF ELECTRIC SHOCK DO NOT OPEN!		WARNING: To reduce the risk of fire or electric shock, DO NOT expose this product to rain or moisture.
--	--	---	---



The lighting flash with arrowhead symbol, within a triangle, alerts the user to "dangerous voltage" which could cause electric shock.



The exclamation point within a triangle is to indicate that the user should read important operating and maintenance instructions in the manual.



CAUTION: Laser radiation when open. Do not stare into beam.

CAUTION: Use of controls or adjustments or performance of procedures, other than those specified herein may result in hazardous radiation exposure.

Notes

- 1) Read these instructions.
 - 2) Keep these instructions.
 - 3) Heed all warnings.
 - 4) Follow all instructions.
 - 5) Do not use near water.
 - 6) Clean only with dry cloth.
 - 7) Do not block any ventilation openings. Maintain well-ventilated conditions around the product. Do not put product on bed, sofa or anything that blocks ventilation. Install in accordance with the manufacturer's instructions.
 - 8) Do not install near any heat sources such as radiators, heat registers, stoves, or other apparatus (including amplifiers) that produce heat.
 - 9) This unit is equipped with a polarized plug. A polarized plug has two blades with one wider than the other. A grounding type plug has two blades and a third grounding prong. The wide blade or the third prong is provided for your safety. If the plug provided doesn't fit in your outlet, consult an electrician for replacement of the obsolete outlet. Removal of the polarized plug will diminish the plugs level of safety.
 - 10) Protect the power cord from being walked on or pinched particularly at plugs, convenience receptacles, and the point where they exit from the apparatus.
 - 11) Only use attachments/accessories specified by the manufacturer.
 - 12) Use only with the cart, stand, tripod, bracket, or table specified by the manufacturer, or sold with the apparatus. When a cart is used, use caution when moving the cart/apparatus combination to avoid injury from tip-over.
- 
- 13) Unplug this apparatus during lightning storms or when unused for long periods of time.
 - 14) Refer all servicing to qualified service personnel. Servicing is required when the apparatus has been damaged in any way, for example, power-supply cord or plug is damaged, liquid has been spilled or objects have fallen into the apparatus, the apparatus has been exposed to rain or moisture, does not operate normally, or has been dropped.
 - 15) Apparatus should not be exposed to dripping or splashing and no objects filled with liquids, such as vases, should be placed on the apparatus.

Note: Do not touch the color TFT LCD screen by hand directly.

Table Of Contents

Introduction	1
Cautions and Warnings	2
Table of Contents	3
Main Features	4
Screen and System Panel Controls	5
Front Panel Controls.....	6
System Side Panel Controls	7
Right Side Panel Controls.....	7
Left Side Panel Controls.....	7
Remote Control	8
System Connections	10
Power Supply Connection.....	10
Connecting to a TV.....	10
Connecting to an Amplifier.....	11
Connecting to a Digital Ready Amplifier.....	11
System Preparations	12
Using of Remote Control.....	12
Disc Formats Supported By This Player.....	13
Power Supply	14
Rechargeable Battery Pack.....	14
Attaching the Battery Pack.....	15
Charging the Battery Pack.....	15
Detaching the Battery Pack.....	16
Using the DC Adapter.....	17
Installing The System Onto Vehicle Seat Back	18
Installing The System Between Vehicle Seats	19
Using Headphones	20
Using Wired Headphone.....	20
DVD Player Operation	20
System Setup	21
Playback Functions	22
Troubleshooting	25
Specifications	28

Main Features

High Quality Audio and Video

LCD (Liquid Crystal Display) Screen

10.2" Color LCD screen.

Special Functions

Supports Multi-angle, Multi-language and Parental-lock features.

AV Input

External Audio/Video signal input can be connected to AV input jacks

Digital Out

Convenient optical digital audio output jack for connection to an external digital processor.

Audio Output

Audio output jack for connection to an external amp or powered speakers.

Video Output

Composite video output for connection to an external monitor.

Headphone Output

For listening to movies or music in private.

Switching Power Adapter

Automatically adapts to voltage requirements in the U.S. and other countries.

Advanced Playing Function

Compatibility

Plays: DVD, DVD-R, DVD-RW, CD, CD-R, CD-RW and JPEG discs are compatible.

ON-Screen Display

ON-screen displays your choice of English /Spanish/French.

Fast Search Function

Multi-speed, fast forward, fast reverse, slow play and repeat playback.

Zoom Function

Allows the viewer to enlarge the picture.

Search By Time

Search for a certain time on a disc.

Last Memory Playback

Continues playback from a stopped point as long as power is applied to the DVD Player.

Region Code

DVD players and discs are coded by region. These regional codes must match. If the codes don't match, the disc cannot be played. This player's code is region 1.

Screen and System Panel Controls

Front Panel Controls

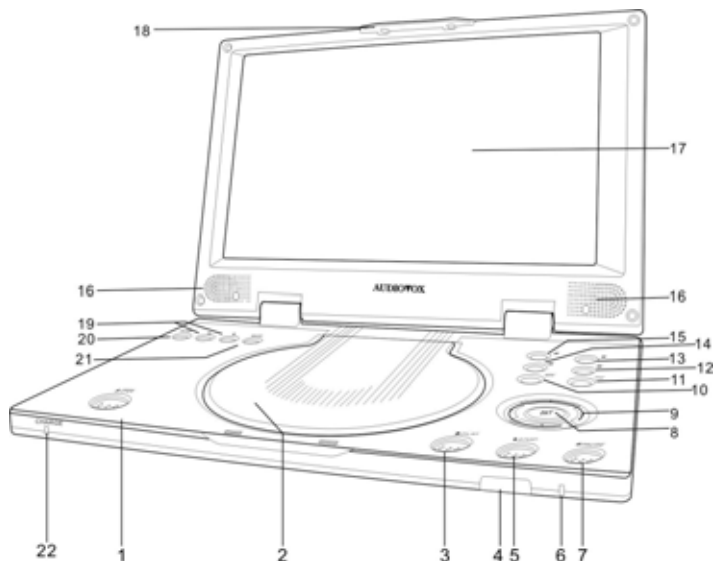

- 1. OPEN button**
Press to open the disc tray cover.
- 2. Disc Tray Cover**
When the disc is loaded gently press the cover to close it.
- 3. PLAY button**
Press to begin playback.
- 4. Remote Sensor**
IR receiver for remote control operation.
- 5. STOP button**
Press to stop playback.
- 6. Power Indicator**
Lights green when the player is in operation.
- 7. PAUSE button**
Press once to pause playback.
Press again to activate step frame by frame playback.

Screen and System Panel Controls

8. ENT button

Press to confirm selection.

9. Direction buttons

Press to select menu items or settings.

10. MENU button

Press to display the disc menu on the LCD screen in Play mode.

11. TITLE button

Press to display titles if present on the DVD disc.

12. ⏩ Next button

Press to skip to the next chapter or track.

13. ⏩ Forward Scan button

Press to scan forward.

14. ⏪ Prev button

Press once to skip to the beginning of the current chapter or track, press twice to skip to the previous chapter or track.

15. ⏪ Reverse Scan button

Press to scan backwards.

16. Speakers

Provide high quality Audio output.

17. LCD Screen

10.2" TFT LCD Panel

18. Latch Hook

Used to lock the LCD panel to the unit.

19. +/-buttons

Used to adjust the brightness, color and contrast level.

20. PICTURE button

Press to enter the brightness, color or contrast level-adjusting mode.

21. MODE button

Press to change the aspect ratio to 4:3 or 16:9, and turn on/off the LCD display.

22. Charge Indicator

When charging the battery pack, the light on the control panel will turn red. When the battery is fully charged the light will turn green.

System Side Panel Controls

Right Side Panel Controls

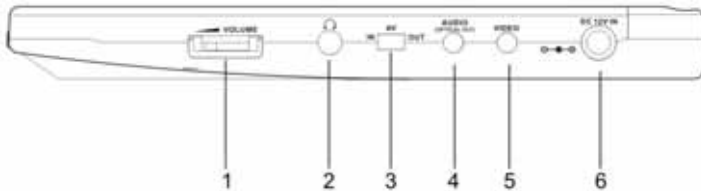

1. Volume Control

Used to adjust the headphone and speaker volume.

2. Headphone Jack

Used to connect wired headphones for private listening. When headphones are connected to this jack the speaker output will turn off automatically.

3. AV IN/OUT Switch

Switch to IN, to input an external Audio/Video source. Switch to OUT when the player is connected to an external monitor.

4. Audio Input/Output and Optical Digital Output Jack.

Used for connection to an external amplifier or digital processor (Optical Cable not supplied) or external audio source.

5. Video Input/Output Jack

Used for connection to an external monitor or video source.

6. DC 12V IN Jack

Used to connect the AC/DC Adaptor or DC Vehicle Adaptor Power to the unit.

Left Side Panel Controls



1. Headphone jack

Used to connect wired headphones for private listening. When headphones are connected to this jack the speaker output will turn off

2. Power ON/OFF Switch

Used to switch the power on or off.

Remote Control

Remote Control

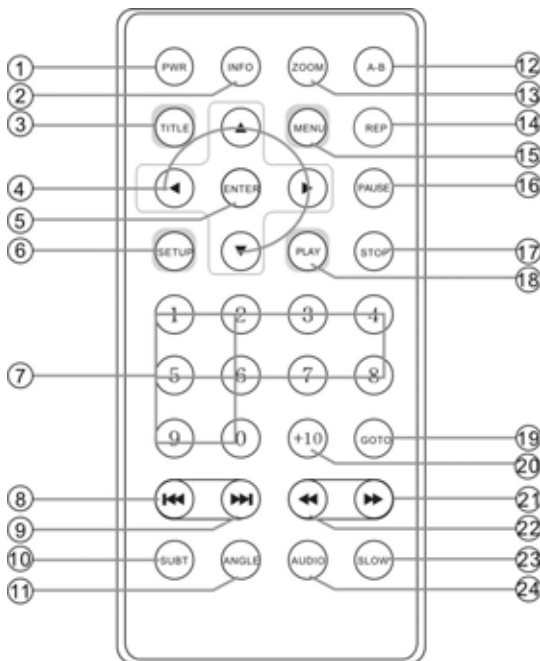

1. PWR button

Press to turn the unit ON or OFF.

2. INFO button

Press to display detailed playback information.

Keep pressing the button to display additional information or to turn the information display OFF.

3. TITLE button

Press to display titles if present on the disc.

4. Direction buttons

Press to select menu items.

5. ENTER button

Press to confirm the items or settings.

6. SETUP button

Press to access the DVD player's setup menu.

7. Number buttons (0-9)

Press to select Password Numbers or go to a specific Track or Time on a disc. (GOTO Function)

Remote Control

8. ⏮ PREV button

Press to go to beginning of current Track or Chapter. Press twice to go to beginning of a previous Track or Chapter.

9. ⏭ NEXT button

Press to go to next Track or Chapter.

10. SUBT button

When a DVD with subtitles is playing, press to select a subtitle language or to turn subtitles OFF.

11. Angle button

Press to access various camera angles, if the DVD disc contains multiple camera angles.

12. A-B Repeat button

Used to play a section of the DVD from point "A" to point "B". Press once to select the starting point (A) press again to select the end point (B). Press a third time to stop the A-B Repeat.

13. ZOOM button

Press to enter and cycle through zoom functions, use the direction buttons (4) to pan around the screen.

14. REP button

Press to repeat a Track, Chapter, Title, or the entire disc.

15. MENU button

Press to access the disc menu.

16. PAUSE button

Press to pause playback, press the PLAY button to resume playback.

17. STOP button

Press once to stop playback. Press the PLAY button to resume normal playback. Press the button twice to stop playback completely.

18. PLAY button

Press to start playback.

19. GOTO button

Press to select the desired disc starting Time, Track or Title.

20. +10 button

Select numbers greater than 9 by pressing the (+10) button first, and then additional number buttons are needed.

21. ⏩ FWD SCAN button

Press to search forwards.

22. ⏪ REV SCAN button

Press to search backwards.

23. SLOW button

Press to activate slow forward.

24. AUDIO button

Press to access various audio languages when the DVD disc contains multiple audio languages.

System Connections

Note: Before plugging the power cord into an AC outlet, make sure that all other connections have been made as described below.

Power Supply Connection

Connect the supplied adapter to the side of the DVD player in the jack marked "DC 12V IN". Plug the two-prong end of the power cord to an AC100-240V outlet. If you have difficulty inserting the plug, turn it over and reinsert it. If the DVD Player will not be used for a long time, disconnect the plug from the outlet.

Connecting to a TV

Audio/video connections

Always ensure that the DVD player, TV and any other electrical components are switched OFF before connecting to the DVD player.

The easiest way to connect the DVD player to a television is via the supplied Audio/Video cable. Connect the audio/video cable from the DVD player to the audio/video inputs of the TV and then switch the AV IN/OUT button to OUT.

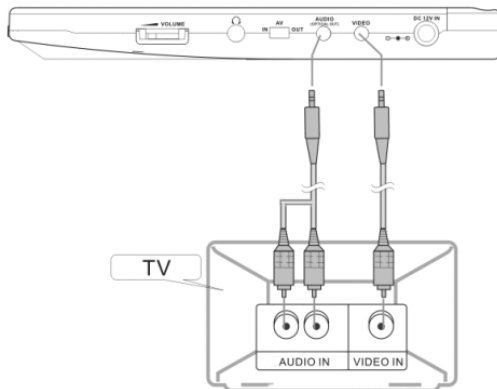

NOTE: Noise may occur in speaker when there is an external audio signal input while playing a DVD disc. Unplug the audio cord to clear the noise.

This player only outputs NTSC signals. Make sure to use a NTSC input type monitor/TV. If the picture is distorted or colorless, please check the monitor/TV type.

System Connections

Connecting to an Amplifier

The DVD player can be connected to an amplifier. Plug the supplied A/V cable into the audio jack on the right side of the unit and plug the other end into an audio input on the amplifier (White= left, Red=Right). Please refer to the equipment's manual before connecting.

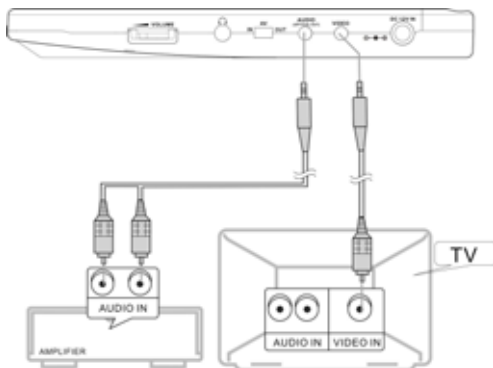

Connecting to a Digital Ready Amplifier

The DVD Player can be connected to an amplifier with a digital optical input. The cable is not supplied, but can be purchased at most home electronics retail stores.

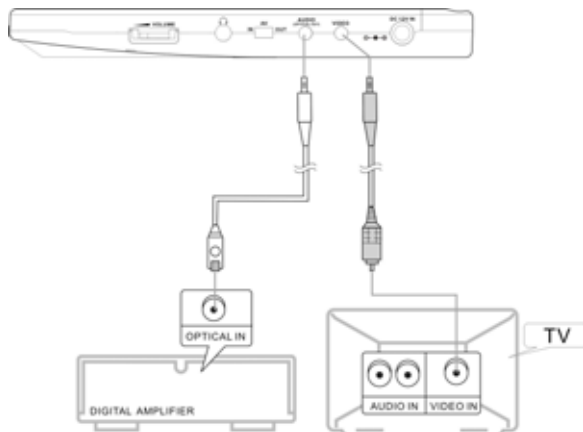

System Preparations

Using of Remote Control

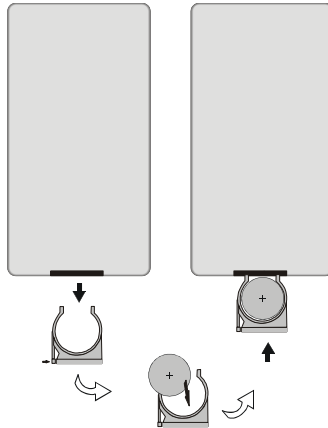



1. Remove the battery holder. Refer to the figure above.
2. Insert the battery into the battery holder (observe correct polarity) and insert the battery holder into the remote control.
3. For best results, aim the remote directly at the player's IR receiver window, within 15 feet, and angles not exceeding 60 degrees.

The path between the remote control and remote sensor should be free of obstructions.

4. Under normal use the battery will last for approximately one year.
5. Remove the battery if the remote is not to be used for a long time.
6. Battery type is a CR2025

System Preparations

Disc Formats Supported By This Player

	DISC LOGO	DIAMETER	PLAYBACK TIME/ PLAYABLE SIDES
DVD		12cm	133 min (SS-SL)
			242 min (SS-DL)
			266 min (DS-SL)
			484 min (DS-DL)
		8cm	41 min (SS-SL)
			75 min (SS-DL)
			82 min (DS-SL)
			150 min (DS-DL)
CD		12cm	74 min
		8cm	20 min

Note: The D2011 is capable of playing most recordable DVDs in the DVD-R format. However due to the variety of recordable DVD disc manufacturers and software manufacturers playback cannot be guaranteed.

The disc maker specifies the operation of some DVD discs. Please refer to the instruction manual with the disc.

Care of Discs

Do not touch the playing surface of the disc.

Do not stick paper or labels on the disc.



Storage of Discs

Do not expose discs to direct sunlight or excessive temperatures.

Cleaning of Discs

If a disc has fingerprints or dust on it, lightly wipe the disc with soft cloth from the center of the disc outward.



Never use record cleaning sprays, or any other solvents to clean your discs.

Power Supply

Rechargeable Battery Pack

Your portable DVD player comes with a lithium ion rechargeable battery that attaches to the rear of the DVD player. Charge the battery fully before initial use. Charging time is typically about 5 hours. A fully charged battery delivers approximately 2-1/2 hours of use, but playing time varies from disc to disc. If the battery will not be used for a long period of time, fully charge the battery prior to storage.

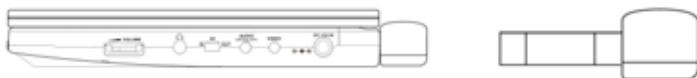

Working conditions and precautions of the battery

- New batteries should be fully charged before initial use.
- Battery should only be used and charged when temperatures are between 32 - 100F.
- Never put the battery in fire or water.
- Do not expose the battery to high temperatures or store in hot, sunny places.
- Maintain well-ventilated conditions around the product to avoid overheating. Don't put the product on bed, sofa or anything that may block ventilation to the product.
- Do not short the battery terminals.
- Do not open the battery.
- Detach the battery after charging is complete. When charging the battery pack, the charge light will turn red, when the charging is complete, the light will turn green.
- Detach the battery when not in use.
- When the battery is weak, "Low Power" will appear on the LCD screen and about one minute later, the player will power OFF automatically.

Power Supply

Attaching the Battery Pack

Refer to the following steps for attaching the Battery Pack:

1. Place the DVD Player on a soft and smooth surface with the bottom of the unit facing UP (chassis up see the Fig.1).
2. With one hand on the DVD Player to prevent it from moving, take the battery and align the four (4) plastic tabs on the battery pack with holes on the player, and push the battery pack into the DVD Player. (see the Fig.1).
3. Slide the Battery Pack until you hear it clicks and locks into place (see the Fig.2).



Fig.1

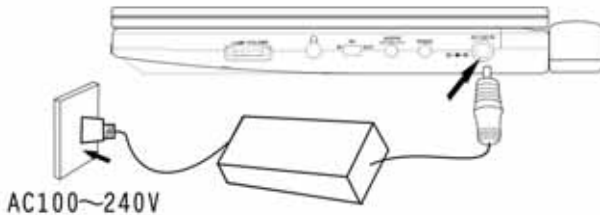

Fig.2

Charging the Battery Pack

The battery pack must be attached to the DVD player to charge it using the supplied AC Power Adapter.

1. Attach the battery pack to the DVD Player.
2. Plug the supplied AC Power Adapter into the player's power jack marked with "DC12V IN", which is located on right side of the DVD Player.
3. Plug the other end of the AC Power Adapter Cord into a household AC Outlet as shown below.



Power Supply

Detaching the Battery Pack

If the DVD Player is not going to be used for a long period of time, the Battery Pack should first be fully charged and then detached from the DVD Player. When the DVD Player is turned OFF, the DVD Player is still consuming some power in STANDBY mode. This will eventually discharge the battery.

Make sure the power is turned OFF before detaching the Battery Pack.

1. Place the player on a soft and smooth surface with the bottom of the unit facing up.
2. Press and hold the Battery Release Tab (1) (located on the bottom) in the direction of the arrow as shown below.
3. Remove the Battery Pack by gently sliding it towards the side of the unit (2).
4. Carefully remove the Battery Pack from your player.

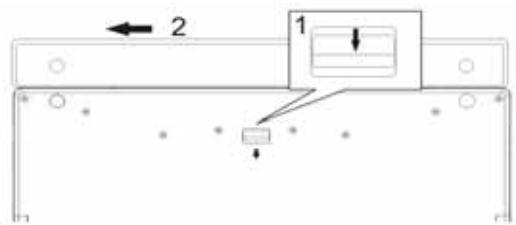

Power Supply

Using the DC Adapter

To use the supplied Vehicle DC Adapter, disconnect the Battery Pack and connect the Vehicle Power Plug Adapter into the DVD Player's Power Jack and the other end into the Vehicle DC outlet (Cigarette Lighter Socket) as shown below.

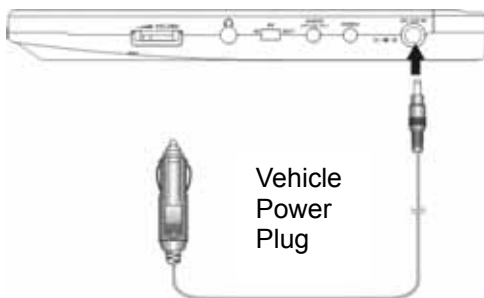

Quick Tips:

- Do not operate the unit while driving a vehicle.
- Place the unit in a secure position for viewing.
- Do not leave battery attached when using car adaptor as power source.
- Do not connect the unit to the car adaptor when starting the car.

Pre-Operation

1. Connect DVD Player to power source.
2. Unlock and lift the LCD screen up.
3. Switch the "POWER" to the "ON" position.
4. Press the "OPEN" button to open the disc cover.
5. Put the disc into the tray with the printed side facing up.
6. Close the disc cover.
7. Adjust the volume with the "VOLUME" control (also adjusts headphone volume if using headphones).

Installing The System Onto Vehicle Seat Back



1. Take one of the supplied straps from the carrier bag and connect the latch to one of the upper metal rings on the mounting bag. Connect the “S” hook to the other upper metal ring and place the loop over the headrest. Adjust the strap until the bag is firmly secured.
2. Take another strap from the carrier bag, and connect the latch to the lower metal ring on the left side of the bag. Attach the “S” hook to the same ring after looping the strap around the seat rail. Repeat this process for the right side. In some vehicles, it may be necessary to attach the “S” connector to the rail directly, as it may not be long enough to reach back to the ring.
3. Adjust the straps tightly so that the bag is secured.

Installing The System Between Vehicle Seats



1. Take one strap and connect the latch to the upper metal ring on the left side of the bag. Attach the "S" hook to the same ring after looping the strap around the headrest of the driver's seat. Repeat this process for the right side (Passenger Seat).
2. Take another strap and connect the latch to lower metal ring on the left side of the bag. Attach the "S" hook to the same ring after looping the strap around the driver's seat rail. Repeat this process for the right side. In some vehicles, it may be necessary to attach the "S" connector directly to the rail, as it may not be long enough to reach back to the ring.
3. Adjust the straps tightly so that the bag is secured.

Using Headphones

Using Wired Headphone

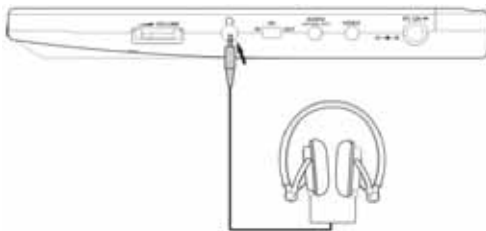

Connect headphones into the headphone jack on the left or right side of the unit.

Quick Tips:

- Excessively loud volume could damage your hearing.
- Turn down the volume before you connect the headphones, and then raise the volume to comfortable level.
- Sound from the DVD Player's external speaker will stop when headphones are connected.

DVD Player Operation

Preparation

1. Turn on the player's power by switching the POWER switch on the side of the player to "ON".
2. Unlatch the LCD panel and lift it up.
3. Press the OPEN button on front panel to open the disc cover.
4. Load disc with the label facing up.
5. Close the disc tray cover, pressing the area of the disc cover that says "Press".
The player will automatically search for the disc and start playback.

Playback of DVD Disc

When the DVD menu appears press the direction buttons (◀ ▶ ▶) to select an option. Press the ENTER or PLAY to start the selected option.

Pause

Press the PAUSE button once on the remote control to pause playback.
Press the PLAY button again to resume normal playback.

Zoom

Press the ZOOM button on the remote control to cycle through the different zoom settings. While in the zoom mode use the direction buttons to move around to different positions on the screen.

Stop

During playback, press the STOP button once on the remote control to stop playback of a disc. Press the PLAY button and the DVD Player will resume playback of the disc from the point where it was stopped.

Screen Mode

Press the MODE button on the front panel to switch the screen aspect ratio between 16:9 and 4:3. Press the MODE button again to turn the screen off and once again to cycle back to 16:9

Previous and Next

Press the PREV  button once to return to the currently playing Chapter or Track.
Press the PREV button twice and playback will start from the previous Chapter or

Track.

Press the NEXT ►► button on the remote control and playback of the disc will start from the next Chapter or Track.

System Setup

You can customize the set up menu to your own preference.

Press the "SETUP" button on the remote control to display the setup menu. The menu will include "General Setup", "Speaker Setup", "Dolby Digital Setup", "Video Setup", and "Preference Setup". Press the direction button (◀ ▶ ▲ ▼) on the remote control to select a category. All the items in the category will appear on the screen. Press the "ENTER" button to enter the category.

Category

When you enter a category all the items under this category will appear, the highlighted category is the current set up.

Press the up/down button (▲ ▼) on the remote control to select another setting (new selection will be highlighted). Press the "ENTER" button for confirmation.

Press the left direction button (◀) to exit the current setup menu and enter other setup menu(s).

General Setup

TV Display

Select Normal/PS or Normal/LB when a 4:3 TV is connected.

Select Wide (16:9) when using the screen on the unit or when a wide screen TV is connected to the video output.

Angle Mark

If the scene was shot from multiple angles, you can change the camera angle of the scene you are watching. Not all DVD discs have this feature.

ON/OFF

With this switched on an angle icon will appear on the screen you will be notified if alternative viewing angles are available.

OSD Lang

There are five different OSD languages for selection. You can select from English, Spanish, French, German, or Italian.

System Setup

Captions

You can choose captions ON or OFF during playback.

Screen Saver

When activated, the unit will go into screensaver mode if the same image remains on the screen for 3 minutes.

Last Memory

Select on, and the unit will resume playback from the point where playback was stopped.

Speaker Setup

Downmix

Select "LT/RT" in DOWNMIX, the player will output the audio signal IN MIXED MONO.

Select "Stereo", then the player will output a stereo signal.

Dolby Digital Setup

Dual Mono

The function is used to select from stereo, left only, right only, and mixed mono.

Dynamic

Use this item to adjust linear dynamic compression rate to get different signal compression effects.

Video Setup

Sharpness

Use this setting to adjust the sharpness level

Brightness

Use this setting to adjust the brightness level.

Contrast

Use this setting to adjust the contrast level.

System Setup

Preference Page

Audio, Subtitle, Disc Menu

This setting allows you to hear or read the subtitles of a DVD in your choice of English, Spanish and French etc. if the disc contains multiple languages.

Parental

DVD discs equipped with the child lock function are rated according to their contents and settings vary from disc to disc. Depending on the disc, you can lock out playback of the disc altogether. Access parental control by pressing the ▲ ▼ (direction buttons) on the remote control, then press the ENTER button.

Password

Parental control features are password protected. The original setting is unlocked. This setting allows you to use number buttons to input any password.

NOTE: The Default Password is 3308. This password is always effective even after you have selected your own password and changed it. To avoid the possibility of others using the default password to set the parental level and change the password, you can record this default password in another area and delete it from this manual. Some discs can be limited depending on the age of users while some discs cannot.

Default Reset

Use this function to reset all the settings.

NOTE: For preference setting the unit must be in the stop mode.

Audio

DVD discs can contain up to 8 audio bit streams. For Example: English, Spanish, French etc.

To select the audio bit stream you prefer press the AUDIO button on the remote control during playback. The DVD player will play the next audio bit stream every time you press the AUDIO button in succession.

NOTE: This function is only available for discs that have several audio bit streams recorded onto it.

Playback Functions

Forward and Reverse Scan

Press the ► and ◀ buttons to Forward or Reverse scan a disc during playback (x2, x4, x8, x16 x32).

Slow Forward

Press the SLOW button to Slow Scan a track on a disc during playback (1/2, 1/4, 1/8, 1/16).

Repeat

Repeat a Title, Chapter or Track by pressing the REP button on the remote control. Continually pressing the REP button will display a menu as follows: Repeat Chapter, Title, All or Off.

You can temporarily select a section of a DVD that you would like to play repeatedly. You do this by marking the start and the end of the section using the A/B button. During playback press the A-B button on the remote control at the beginning of the segment (point A) you wish to play repeatedly. Press the A-B button again to mark the end of the segment (point B).

The DVD player will automatically return to point A and repeat playback of the selected segment (A-B). To resume normal playback, press the A-B button again.

Subtitle

A DVD disc can be recorded with up to 32 subtitles.

Press the SUBT button on the remote control during playback to select the one you prefer.

NOTE: This function is only available on DVD discs that are recorded with multi-subtitles.

Angle

If the scene was recorded from multiple angles, you can change the camera angle of the scene you are watching.

Press the ANGLE button on the remote control during playback. Playback will shift to another angle. If the disc menu gives the options of angles items, you can switch angles for viewing by pressing the number buttons on the remote control.

NOTE: This function is only available if a disc has multiple angles recorded on the disc.

Playback Functions

Search by time

During DVD disc playback, press the GOTO button on the remote control once, there will be a menu displayed on the screen. You can set or select items for your preference. Use the ▲▼ direction buttons to select the desired item. Press the ◀ direction button to return. Select Title or Chapter and use the number buttons to input the desired title or chapter number.

NOTE: Some DVD discs may not support this function.

Resume Playback

Press the STOP button at the point if you wish to stop the playback of a disc. The DVD Player will memorize the location where playback of the disc was stopped.

Press the PLAY button to resume normal playback. The DVD Player will resume the playback of the disc from the location where it was stopped. This function will not operate if the disc is removed from the DVD Player.

Press the STOP button twice (2). Playback of the disc will stop. When the PLAY button is pressed again, playback of the disc will start from the beginning of disc.

Playback Functions

Playing a JPEG

JPEG is a common picture format. Hundreds of pictures can be stored in a disc in this format and viewed on the LCD screen.

Normal Playback

Load a JPEG disc into the DVD Player. After reading the disc, the DVD Player will display the images on the disc in sequence. Press the STOP button to return to the root menu.

Press the MENU button to enter the preview menu. Use the direction buttons to select the picture you wish to view and then press the ENTER button to confirm and start playback. During playback of the disc, use the ◀◀ and ▶▶ buttons to select the next picture or previous picture.

Picture Rotation

The picture can be rotated by using the cursor buttons.

Picture Zoom

The ZOOM button is used to enlarge the picture by 2x, 3x or 4x the normal size or reduce the picture by 1/2, 1/3, or 1/4 normal size. First press the ZOOM button to open the zooming function, then use the fast forward or reverse scan button to enlarge or reduce the picture.

With the zoom function turned ON, use the direction buttons to move to a desired position of the picture.

When the ZOOM function is turned off, the picture will display normally.

- Some JPEG discs can be played normally but with no rotate or zoom functions depending on how the disc was produced.

Troubleshooting

Symptom	How To Check
The player cannot play.	<ul style="list-style-type: none">• Make sure the AV IN/OUT switch on the right side of the player unit is in the OUT position for standard play.• Make sure the disc cover is completely closed.• Make sure a disc is loaded.• Make sure the disc is loaded with label side up.• Disc should be clean, not dirty or warped.• Player's region code should be the same as the region code of the DVD disc.• Make sure water condensation has not occurred? If it has, remove the disc and keep the player power on until the moisture evaporates.
There is no sound.	<ul style="list-style-type: none">• Make sure the system connection is correct.• Make sure the sound setup of DVD disc is correct.• Is your disc dirty or warped? Clean or replace it.• If wired headphones are plugged in, unplug them.
There is no picture.	<ul style="list-style-type: none">• Make sure DVD Player is turned on and in correct video mode.• Make sure your system connection is correct.
Poor AV performance.	<ul style="list-style-type: none">• Is your disc dirty or warped? Clean or replace it.
Cannot continue to play and play a section repeatedly.	<ul style="list-style-type: none">• Make sure the player is not in A-B repeat status.• Press A-B button to cancel A-B repeat status.• Is your disc dirty or warped? Clean or replace it.
The remote control does not work.	<ul style="list-style-type: none">• Make sure there is no obstruction between the remote control and the player.• Make sure you are pointing the remote control towards the player.• Make sure battery is inserted correctly (check polarity).• Replace weak battery.

WARNING: Do not touch any metal objects to the Battery connectors, as it will put the Battery in standby mode. To exit the standby mode, connect the Battery and DVD Player to AC or DC power.

Other possibilities:

Static or other external interference may cause the player to function abnormally. Unplug the power-supply cord from the outlet and plug it in again to reset the player so that normal operation can resume. If you are still having problems, then disconnect the power to the DVD Player and consult a qualified technician.

Specifications

Screen Resolution		800 x 480
TFT Screen Size		10.2 inches (259.08mm) (16:9)
Laser Wavelength		Wavelength: 780/650nm
Video System		NTSC
Frequency Response		20Hz□20kHz ±2.5dB
Audio Signal-to-Noise		≥ 85 dB
Audio Distortion + Noise		≤ -70dB (1KHz)
Channel Separation		≥ 70dB (1KHz)
Dynamic Range		≥ 80dB (1KHz)
Audio Out	Analog Audio Out	Output Level: 1.5V ^{0.2} ± _{1.0} , Load: 10KΩ
Video Out	Video Out	Output Level: 1V _{p,p} ±0.2, Load: 75Ω Unbalanced Negative
Power	AC100-240V□50/60Hz	
Power Consumption	□25W	
Dimension w (o) battery	10.51in (267mm)×8.38in (213mm) 7.16in (182 mm)×1.22in (31mm)	
Weight w/o battery	About 3.30/2.71lbs (1.5/1.23 kgs)	

DESIGN AND SPECIFICATIONS ARE SUBJECT TO CHANGE WITHOUT NOTICE

Manufactured under license from Dolby Laboratories.
 “Dolby” and the double-D symbol are trademarks of Dolby Laboratories.
 Confidential unpublished works. © 1992 -1997 Dolby Laboratories.
 All rights reserved.

WARRANTY



AUDIOVOX
ELECTRONICS CORP.

90 DAY LIMITED WARRANTY *Applies to Audiovox Video Products*

AUDIOVOX ELECTRONICS CORP. (the Company) warrants to the original retail purchaser of this product that should this product or any part thereof, under normal use and conditions, be proven defective in material or workmanship within ninety (90) days from the date of original purchase, such defect(s) will be repaired or replaced with reconditioned product (at the Company's option) without charge for parts and repair labor. A game controller, if supplied, is similarly warranted for ninety (90) days.

To obtain repair or replacement within the terms of this Warranty, the product is to be delivered with proof of warranty coverage (e.g. dated bill of sale), specification of defect(s), transportation prepaid, to the Company at the address shown below.

This Warranty does not extend to the elimination of externally generated static or noise, to correction of antenna problems, to costs incurred for installation, removal or reinstallation of the product, or to damage to digital memory cards, discs, speakers, accessories, or electrical systems.

This Warranty does not apply to any product or part thereof which, in the opinion of the Company, has suffered or been damaged through alteration, improper installation, mishandling, misuse, neglect, accident, or by removal or defacement of the factory serial number/bar code label(s). THE EXTENT OF THE COMPANY'S LIABILITY UNDER THIS WARRANTY IS LIMITED TO THE REPAIR OR REPLACEMENT PROVIDED ABOVE AND, IN NO EVENT, SHALL THE COMPANY'S LIABILITY EXCEED THE PURCHASE PRICE PAID BY PURCHASER FOR THE PRODUCT.

This Warranty is in lieu of all other express warranties or liabilities. ANY IMPLIED WARRANTIES, INCLUDING ANY IMPLIED WARRANTY OF MERCHANTABILITY, SHALL BE LIMITED TO THE DURATION OF THIS WRITTEN WARRANTY. ANY ACTION FOR BREACH OF ANY WARRANTY HEREUNDER INCLUDING ANY IMPLIED WARRANTY OF MERCHANTABILITY MUST BE BROUGHT WITHIN A PERIOD OF 24 MONTHS FROM DATE OF ORIGINAL PURCHASE. IN NO CASE SHALL THE COMPANY BE LIABLE FOR ANY CONSEQUENTIAL OR INCIDENTAL DAMAGES FOR BREACH OF THIS OR ANY OTHER WARRANTY, EXPRESS OR IMPLIED, WHATSOEVER. No person or representative is authorized to assume for the Company any liability other than expressed herein in connection with the sale of this product.

Some states do not allow limitations on how long an implied warranty lasts or the exclusion or limitation of incidental or consequential damage so the above limitations or exclusions may not apply to you. This Warranty gives you specific legal rights and you may also have other rights which vary from state to state.

AUDIOVOX ELECTRONICS CORPORATION, 150 MARCUS BLVD. HAUPPAUGE, NEW YORK. 11788 1-800-645-4994
CANADA : CALL 1-800-645-4994 FOR LOCATION OF WARRANTY STATION SERVING YOUR AREA

© 2005 Audiovox Electronics Corporation

128-5556E



For Customer Service
Visit Our Website At
www.audiovox.com
Product Information, Photos,
FAQ's Owner's Manuals