

Register your product and get support at
www.philips.com/welcome

PV7002i

PV9002i



User manual

PHILIPS

Contents

1	Important Safety Instructions	2
----------	--------------------------------------	----------

2	Your in-car entertainment system	4
	What's in the box	4
	Compatible iPod/iPhone	5

3	Get started	6
	Mount screens to the headrests	6
	Mount screens to the headrests	7
	Connect the car outlet adaptor	8
	Connect your iPhone/iPad/iPod	8
	Use the cup holder stand	9
	Manage the docking cable in your car	10

4	Play	12
	Adjust volume	13
	Use the headphone splitter	13

5	Specifications	15
----------	-----------------------	-----------

6	Troubleshooting	16
----------	------------------------	-----------

7	Notice	17
----------	---------------	-----------

1 Important Safety Instructions

- Heed all warnings.
- Follow all instructions.
- Do not use this apparatus near water.
- Clean only with dry cloth.
- Do not block any ventilation openings. Install in accordance with the manufacturer's instructions.
- Do not install near any heat sources such as radiators, heat registers, stoves, or other apparatus (including amplifiers) that produce heat.
- Protect the power cord from being walked on or pinched, particularly at plugs, convenience receptacles, and the point where they exit from the apparatus.
- Only use attachments/accessories specified by the manufacturer.
- Unplug this apparatus during lightning storms or when unused for long periods of time.
- Refer all servicing to qualified service personnel. Servicing is required when the apparatus has been damaged in any way, such as power-supply cord or plug is damaged, liquid has been spilled or objects have fallen into the apparatus, the apparatus has been exposed to rain or moisture, does not operate normally, or has been dropped.
- Apparatus shall not be exposed to dripping or splashing.
- Do not place any sources of danger on the apparatus (e.g. liquid filled objects, lighted candles).
- Where the MAINS plug or an appliance coupler is used as the disconnect device, the disconnect device shall remain readily operable.



Warning

- Never remove the casing of this apparatus.
- Make sure that you always have easy access to the car adaptor, plug or adaptor to disconnect the apparatus from the power.

Know these safety symbols



This 'bolt of lightning' indicates uninsulated material within your unit may cause an electrical shock. For the safety of everyone in your household, please do not remove product covering.

The 'exclamation point' calls attention to features for which you should read the enclosed literature closely to prevent operating and maintenance problems.

WARNING: To reduce the risk of fire or electric shock, this apparatus should not be exposed to rain or moisture and objects filled with liquids, such as vases, should not be placed on this apparatus.

CAUTION: To prevent electric shock, match wide blade of plug to wide slot, fully insert.

Norge

Typeskilt finnes på apparatens underside.

Observer: Nettbryteren er sekundært innkoplet. Den innebygde nettdelen er derfor ikke frakoplet nettet så lenge apparatet er tilsluttet nettkontakten.

For å redusere faren for brann eller elektrisk støt, skal apparatet ikke utsettes for regn eller fuktighet.

2 Your in-car entertainment system

Congratulations on your purchase, and welcome to Philips! To fully benefit from the support that Philips offers, register your product at www.philips.com/welcome.

What's in the box

Check that you have received the following items:

- LCD screens with mounting straps
- Cup holder stand
- iPhone/iPad/iPod video and charging cable
- Cable tie
- Headphone splitter
- Carrying bag
- Car outlet adapter
- User manual



Note

- The images serve as reference only. Philips reserves the right to change color/design without notice.

Compatible iPod/iPhone

The set supports the following iPod/iPhone models.

Made for:

- iPod touch (1st, 2nd, 3rd, and 4th generation)
- iPad (1st, 2nd and 3rd generation)
- iPod nano (5th and 6th generation)
- iPhone 4S
- iPhone 4
- iPhone 3GS
- iPhone 3G
- iPhone

3 Get started

Always follow the instructions to install your twin dock player in your car.

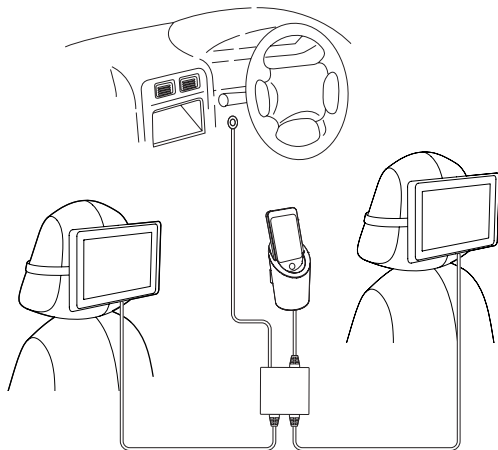

Mount screens to the headrests

- 1 Position the screen on the back of the headrest and pull the mounting strap around the headrest.
- 2 Attach the mounting strap to secure the screen to the headrest.
- 3 Follow the steps above to mount the other screen to the headrest.

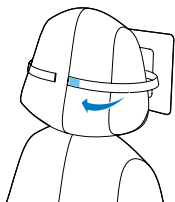

1

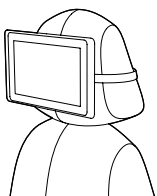

2

Mount screens to the headrests

Connect the iPhone/iPad/iPod cable to the dock cable jack of the screens.

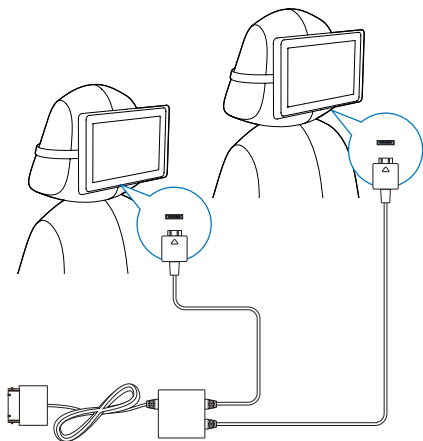

Connect the car outlet adaptor

- 1 Connect the car outlet adaptor to the car outlet.
- 2 Connect the power plug to the iPhone/iPad/iPod cable.

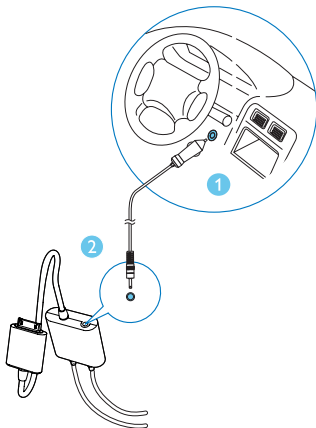

Connect your iPhone/iPad/iPod

Connect your iPhone/iPad/iPod to the docking connector on the iPhone/iPad/iPod cable.

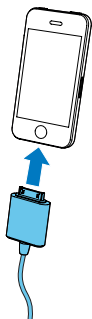

Use the cup holder stand

- 1 Put the cup holder stand into the cup holder.

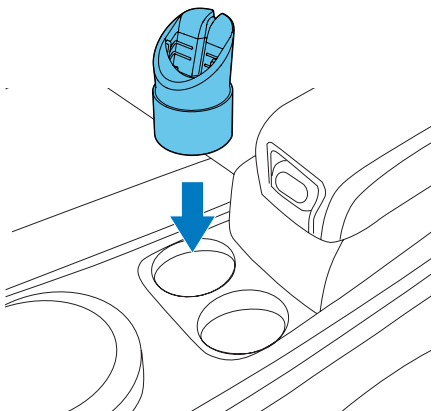

- Put your iPhone into the cup holder stand with the iPhone/iPad/iPod cable attached and routed through the grooves on the back of the stand.

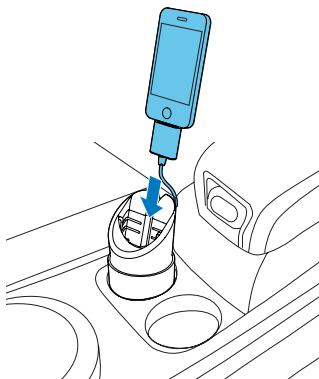

Note

- The cup holder supports only the iPhone 4 without a protective case.

Manage the docking cable in your car

- Route the cables around the bars under the headrests of the backseats.
- Attach the screen splitter section of the iPhone/iPad/iPod cable to the car using the adhesive provided.
- Tie the car adaptor cable and the iPhone/iPad/iPod dock cable together with the cable tie.

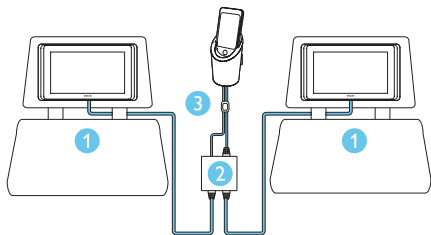

4 Play

Select video or media you would like to play on iPhone/iPad/iPod.

↳ The media player interface will display on iPhone/iPad/iPod screen.

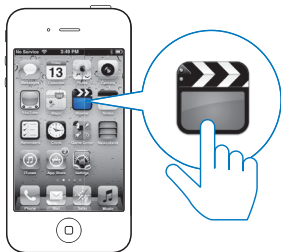

↳ Media will play on the TwinPlay screens.

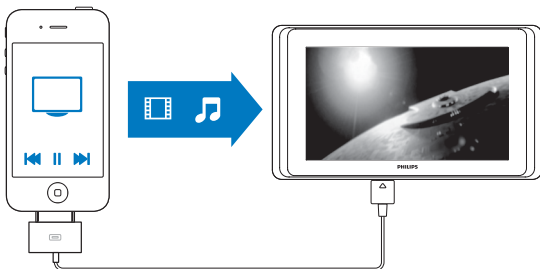

Adjust volume

Spin the wheel clockwise or counter-clockwise to adjust the volume of built-in speakers.

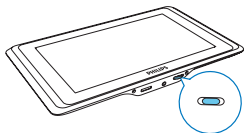

Use the headphone splitter

Use the headphone splitter to connect two sets of headphones, allowing you and your friend to enjoy movies or music together without disturbing others.



Note

- The headphones in the picture are not supplied.

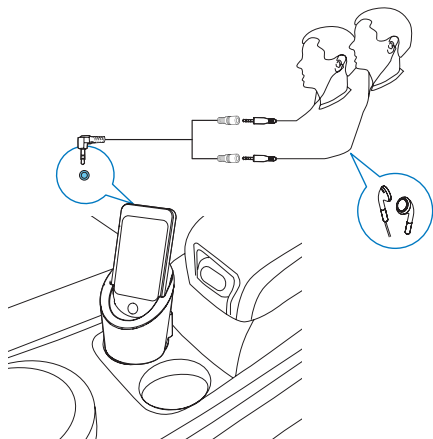

5 Specifications

Amplifier

Rated Output Power	2 X 0.6 W RMS
Signal to Noise Ratio	> 55 dBA

General information

Input Power	Car cord 12V
Output Power	12V 2 A
Operation Power Consumption	18 W
Standby Power Consumption	<1 W
Max. load for iPod/iPhone/iPad	5V 2.1 A
Dimensions of PV9002i	
Main Unit (W x H x D)	266 x 152 x 19.3 mm
Dimensions of PV7002i	
Main Unit (W x H x D)	217.3 x 124.3 x 18.5 mm
Weight of PV9002i	
Main Unit	0.435 kg
With Packing	1.433 kg
Weight of PV7002i	
Main Unit	0.29 kg
With Packing	1.064 kg



Note

- The following iPod models are not supported: iPod classic, iPod 4G, iPod 5G.

6 Troubleshooting



Warning

- Never remove the casing of this apparatus.

To keep the warranty valid, never try to repair the system yourself.

If you encounter problems when using this apparatus, check the following points before requesting service. If the problem remains unsolved, go to the Philips web site (www.philips.com/support). When you contact Philips, ensure that the apparatus is nearby and the model number and serial number are available.

Does the product support mirroring of screen of iDevices?

- No. When movies or photo slideshows are played on LCD screens, your iPod/iPhone/iPad would not play the same material simultaneously.

I only hear sound but no video display on the screens. What do shall I do?

- Please make sure your iPod/iPhone/iPad and screen side plugs are well connected.
- The product supports only Standard Definition (SD) video. High Definition (HD) video is not supported.
- When play MP3 music, there is also no video display on the screen.

Video on the screen are not centered.

- You might occasionally experience this when playing an online video which does not fully satisfy Apple video connector specification.

I cannot show photo to the product screen.

- When viewing photos, please set your iPod/iPhone/iPad to photo slideshow mode.

The volume is not changed when I adjust the iPhone/iPod/iPad volume.

- The volume is controlled by the volume key on the unit, it will not be changed if you adjust the iPhone/iPod/iPad, and it is normal.

7 Notice

Any changes or modifications made to this device that are not expressly approved by Philips Consumer Lifestyle may void the user's authority to operate the equipment.



This product complies with the radio interference requirements of the European Community.



Your product is designed and manufactured with high quality materials and components, which can be recycled and reused.



When this crossed-out wheeled bin symbol is attached to a product it means that the product is covered by the European Directive 2002/96/EC.

Please inform yourself about the local separate collection system for electrical and electronic products.

Please act according to your local rules and do not dispose of your old products with your normal household waste. Correct disposal of your old product helps to prevent potential negative consequences for the environment and human health.

Environmental information

All unnecessary packaging has been omitted. We have tried to make the packaging easy to separate into three materials: cardboard (box), polystyrene foam (buffer) and polyethylene (bags, protective foam sheet.)

Your system consists of materials which can be recycled and reused if disassembled by a specialized company. Please observe the local regulations regarding the disposal of packaging materials, exhausted batteries and old equipment.



Be responsible
Respect copyrights

The making of unauthorized copies of copy-protected material, including computer programs, files, broadcasts and sound recordings, may be an infringement of copyrights and constitute a criminal offence. This equipment should not be used for such purposes.

Made for



iPod



iPhone



iPad

“Made for iPod,” “Made for iPhone,” and “Made for iPad” mean that an electronic accessory has been designed to connect specifically to iPod, iPhone, or iPad, respectively, and has been certified by the developer to meet Apple performance standards. Apple is not responsible for the operation of this device or its compliance with safety and regulatory standards. Please note that the use of this accessory with iPod, iPhone, or iPad may affect wireless performance.

iPod and iPhone are trademarks of Apple Inc., registered in the U.S. and other countries. iPad is a trademark of Apple Inc.



Specifications are subject to change without notice
© 2012 Koninklijke Philips Electronics N.V.
All rights reserved.

PV7002i/PV9002i_12_UM_V1.0