

# clarion®

Owner's manual  
Mode d'emploi  
Manual de instrucciones

## DB245

AM/FM CD PLAYER

•  
RADIO AM/FM-LECTEUR CD

•  
RADIO DE AM/FM REPRODUCTOR DE CD

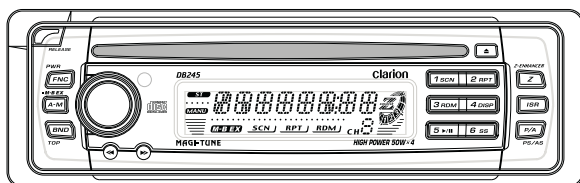

COMPACT  
disc  
DIGITAL AUDIO

# Contents

1. FEATURES .....	2
2. CONTROLS .....	3
Source Unit .....	3
Display .....	3
3. BUTTON TERMINOLOGY .....	4
Names of the Buttons and their Functions .....	4
4. PRECAUTIONS .....	5
5. HANDLING COMPACT DISCS .....	6
6. DCP (DETACHABLE CONTROL PANEL) .....	7
7. REMOTE CONTROL .....	8
Function of Remote Control Unit Buttons .....	9
8. OPERATIONS .....	10
Basic Operations .....	10
Radio Mode Operations .....	12
CD Mode Operations .....	13
9. TROUBLESHOOTING .....	15
10. ERROR DISPLAYS .....	16
11. SPECIFICATIONS .....	17

## 1. FEATURES

- Visible Blue Negative LCD and White Illuminated Buttons
- Aluminum Detachable Faceplate
- Rotary Volume for Easy Operation
- Z-Enhancer with 3 Mode Sound Selector
- MAGNA BASS EX for Dynamic Bass Tuning
- MAGI-TUNE® FM Reception System
- Seek / Manual Up / Down Tuning
- 8-Times Oversampling Digital Filter and Dual 1-Bit D/A Converters
- Preset Station Scan (PS), Automatic Store (AS)
- 2-Channel RCA Line Level Output
- AM 1 Band, FM 3 bands each 6 channels total 24 channels, Preset Memory Function
- Repeat / Random Play / Intro Music Scan
- 200W (50 W X 4) Maximum Power Output
- IR Remote Control Included

*Be sure to unfold and read the next page.  
Veuillez déployer et vous référer à la page suivante.  
Cerciórese de desplegar y de leer la página siguiente.*

## 2. CONTROLS / COMMANDES / CONTROLES

**Note :** Be sure to unfold this page and refer to the front diagrams as you read each chapter.  
**Remarque:** Veuillez déployer cette page et vous référer aux schémas quand vous lisez chaque chapitre.  
**Nota:** Cuando lea los capítulos, despliegue esta página y consulte los diagramas.

### SOURCE UNIT / APPAREIL PILOTE / UNIDAD FUENTE

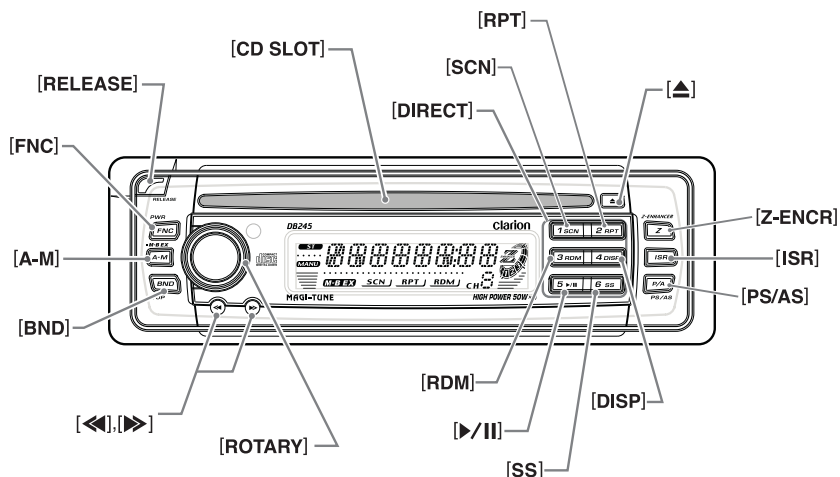

### DISPLAY / AFFICHEUR / VISUALIZADOR

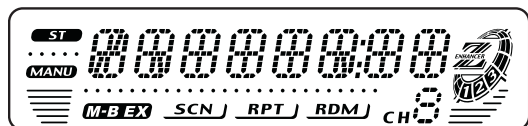

## 3. BUTTON TERMINOLOGY

**Note:**  
• Be sure to read this chapter referring to the front diagrams of chapter "2. CONTROLS" on page 3.

### Names of the Buttons and their Functions

#### [RELEASE] button

- Press the [RELEASE] button to unlock the DCP.

#### [Z-ENCR] button

- Use the button to select one of the three types of sound characteristics already stored in memory. (Z-Enhancer)

#### [FNC] button

- Press the button to turn on the power. Press and hold the button for 1 second or longer to turn off the power.
- Switches the operation mode among radio and CD mode.

#### [A-M] button

- Press and hold the button for 2 seconds or longer to switch the MAGNA BASS EX on/off.
- Use the button to switch to the audio mode (bass, treble, balance, fader)

#### [ROTARY] knob

- Adjust the volume by turning the knob clockwise or counterclockwise.
- Use the knob to perform various setting.

#### [CD SLOT]

- CD insertion slot.

#### [SCN] button

- Performs scan play for 10 seconds for each track while in the CD mode.

#### [▲] button

- Ejects a CD when it is loaded into the unit.

#### [RPT] button

- Plays repeatedly while in the CD mode.

#### [RDM] button

- Performs random play while in the CD mode.

#### [ISR] button

- Recalls ISR radio station in memory.
- Press and hold for 2 seconds or longer: Stores current station into ISR memory (radio mode only).

#### [DIRECT] button

- Stores a station into memory or recall it directly while in the radio mode.

#### [SS] button

- Press the [SS] button while keeping the [BND] button pressed, to turn the screen saver function on or off.

#### [▶/||] button

- Plays or pauses a CD while in the CD mode.

#### [DISP] button

- Press the [DISP] button while keeping the [BND] button pressed, to switch the display indication (Main display, clock display).

#### [PS/AS] button

- Performs preset scan while in the radio mode. When the button is pressed and held, auto store is performed.

#### [◀], [▶] button

- Selects a station while in the radio mode or selects a track when listening to a CD.
- Press and hold the button for 1 second or longer to switches the fast-forward/fast-backward.

#### [BND] button

- Switches the band, or seek tuning or manual tuning while in the radio mode.
- Plays a first track while in the CD mode.

# 4. PRECAUTIONS

1. When the inside of the car is very cold and the player is used soon after switching on the heater, moisture may form on the disc or the optical parts of the player and proper playback may not be possible. If moisture forms on the disc, wipe it off with a soft cloth. If moisture forms on the optical parts of the player, do not use the player for about one hour and the condensation will disappear naturally to allow normal operation.
2. Driving on extremely bumpy roads which cause severe vibration may cause the sound to skip.
3. This unit uses a precision mechanism. Even in the event that trouble arises, never open the case, disassemble the unit, or lubricate the rotating parts.

This equipment has been tested and found to comply with the limits for a Class B digital device, pursuant to Part 15 of the FCC Rules.

These limits are designed to provide reasonable protection against harmful interference in a residential installation.

This equipment generates, uses, and can radiate radio frequency energy and, if not installed and used in accordance with the instructions, may cause harmful interference to radio communications. However, there is no guarantee that interference will not occur in a particular installation.

If this equipment does cause harmful interference to radio or television reception, which can be determined by turning the equipment off and on, the user is encouraged to consult the dealer or an experienced radio/TV technician for help.

## CAUTION

**USE OF CONTROLS, ADJUSTMENTS, OR PERFORMANCE OF PROCEDURES OTHER THAN THOSE SPECIFIED HEREIN, MAY RESULT IN HAZARDOUS RADIATION EXPOSURE. THE COMPACT DISC PLAYER SHOULD NOT BE ADJUSTED OR REPAIRED BY ANYONE EXCEPT PROPERLY QUALIFIED SERVICE PERSONNEL.**

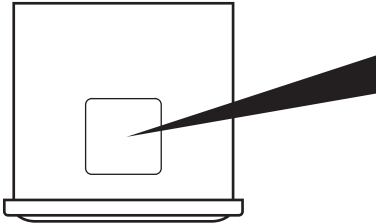

Bottom View of Source Unit

MODEL **DB245** clarion

**12V  $\ominus$  GROUND**  
**AM 530-1710kHz/FM 87.9-107.9MHz**

THIS DEVICE COMPLIES WITH PART 15 OF THE FCC RULES. OPERATION IS SUBJECT TO THE FOLLOWING TWO CONDITIONS:  
(1) THIS DEVICE MAY NOT CAUSE HARMFUL INTERFERENCE, AND  
(2) THIS DEVICE MUST ACCEPT ANY INTERFERENCE RECEIVED, INCLUDING INTERFERENCE THAT MAY CAUSE UNDESIRABLE OPERATION.

THIS PRODUCTION COMPLIES WITH DHHS RULES 21 CFR SUBCHAPTER J APPLICABLE AT DATE OF MANUFACTURE.

CLARION CO., LTD.  
50 KAMITODA, TODA-SHI, SAITAMA-KEN, JAPAN.

MANUFACTURED:

SERIAL No.  
PE-2642U

286-6299-00  
Clarion Co., Ltd.  
MADE IN MALAYSIA

### **INFORMATION FOR USERS:**

**CHANGES OR MODIFICATIONS TO THIS PRODUCT NOT APPROVED BY THE MANUFACTURER WILL VOID THE WARRANTY AND WILL VIOLATE FCC APPROVAL.**

# 5. HANDLING COMPACT DISCS

This unit has been designed specifically for playback of compact discs bearing the  mark. No other discs can be played.

To remove the compact disc from its storage case, press down on the center of the case and lift the disc out, holding it carefully by the edges.

Removing the disc

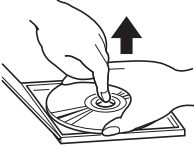

Proper way to hold the compact disc



Always handle the compact disc by the edges. Never touch the surface.

To remove fingermarks and dust, use a soft cloth, and wipe in a straight line from the center of the compact disc to the circumference.

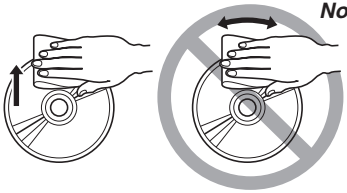

New discs may have some roughness around the edges. The unit may not work or the sound may skip if such discs are used. Use a ball-point pen, etc. to remove roughness from the edge of the disc.

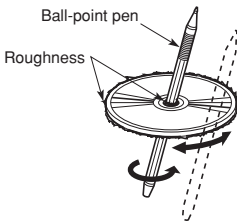

## Note on Compact Discs

Never stick labels on the surface of the compact disc or mark the surface with a pencil or pen.

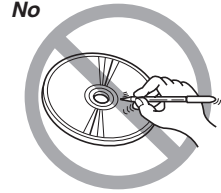

Do not use any solvents such as commercially available cleaners, anti-static spray, or thinner to clean compact discs.

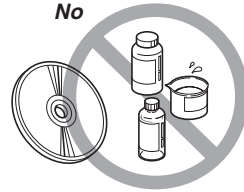

Do not use compact discs that have large scratches, are misshapen, or cracked, etc. Use of such discs will cause misoperation or damage.

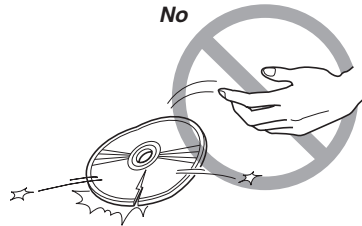

Do not expose compact discs to direct sunlight or any heat source.

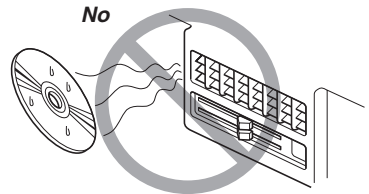

### Note:

- Do not use commercially available CD protection sheets or discs equipped with stabilizers, etc. These may get caught in the internal mechanism and damage the disc.

# 6. DCP (DETACHABLE CONTROL PANEL)

The control panel can be detached to prevent theft. When detaching the control panel, store it in the DCP (DETACHABLE CONTROL PANEL) case to prevent scratches.

We recommend taking the DCP with you when leaving the car.

## Removing the DCP

1. Press the **[FNC]** button for 1 second or longer to switch off the power.
2. Press in the **[RELEASE]** button.

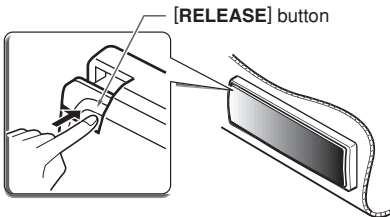

\* The DCP is unlocked

3. Remove the DCP.

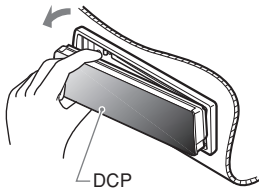

## Attaching the DCP

1. Insert the right side of the DCP into the main unit.
2. Insert the left side of the DCP into the main unit.

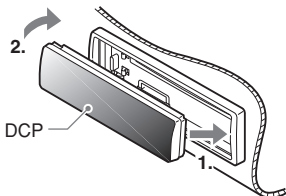

## Storing the DCP in the DCP Case

Hold the DCP, in the orientation as shown in the figure below, and put it into the supplied DCP case. (Ensure the DCP is in the correct orientation.)

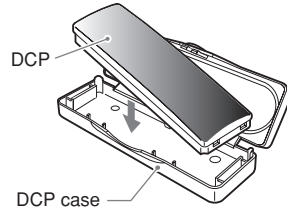

## ⚠ CAUTION

- The DCP can easily be damaged by shocks. After removing it, be careful not to drop it or subject it to strong shocks.
- When the Release button is pressed and the DCP is unlocked, the car's vibrations may cause it to fall. To prevent damage to the DCP, always store it in its case after detaching it. (See figure above.)
- The connector connecting the main unit and the DCP is an extremely important part. Be careful not to damage it by pressing on it with fingernails, pens, screwdrivers, etc.

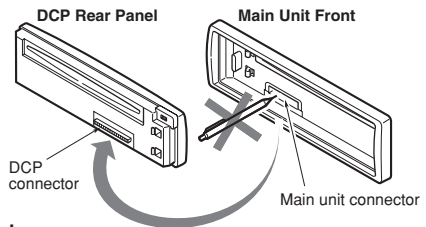

### Note:

- If the DCP is dirty, wipe off the dirt with a soft, dry cloth only.

# 7. REMOTE CONTROL

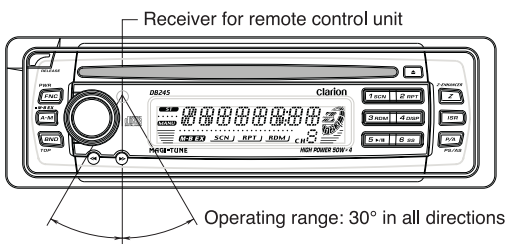

## Remote control unit

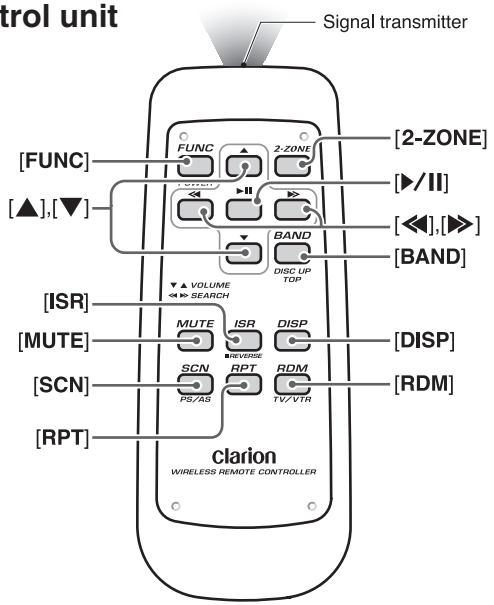

## Inserting the Batteries

1. Turn the remote control unit over, then slide the rear cover in the direction of the arrow.
2. Insert the AA (SUM-3, IECR-6/1.5V) batteries that came with the remote control unit facing in the directions shown in the figure, then close the rear cover.

### Notes:

Using batteries improperly can cause them to explode. Take note of the following points:

- When replacing batteries, replace both batteries with new ones.
- Do not short-circuit, disassemble or heat batteries.
- Do not dispose of batteries into fire or flames.
- Dispose of spent batteries properly.

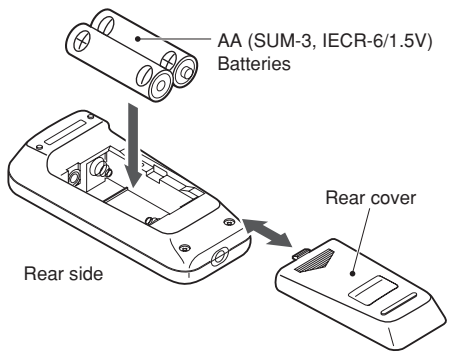

# Functions of Remote Control Unit Buttons

Mode Button	Radio	CD
[FUNC]	Turns power on and off. When press and held for 1 second: Turns power off. Switches between radio and CD.	
[BAND]	Switches reception band.	Plays the first track. Top play.
[▲] , [▼]	Increases and decreases volume (in all modes).	
[◀] , [▶]	Moves preset channels up and down.	Moves tracks up and down. When pressed and held for 1 second: Fast-forward/ fast-backward.
[▶/II]	Turns mute on and off	Switches between playback and pause.
[MUTE]	Turns mute on and off.	Switches between playback and pause.
[ISR]	Recalls ISR radio station in memory. Press and hold for 2 seconds or longer: Stores current station into ISR (radio mode only).	
[DISP]	Switches among main display, clock display.	
[SCN]	Preset scan. When pressed and held for 2 seconds: Auto store.	Scan play.
[RPT]	No function	Repeat play.
[RDM]	No function	Random play.

\* Some of the corresponding buttons on the main unit and remote control unit have different functions.

\* 2-ZONE button is not available.



# 8. OPERATIONS

## Basic Operations

**Note:** Be sure to read this chapter referring to the front diagrams of chapter "2. CONTROLS" on page 3.

### ⚠ CAUTION

Be sure to lower the volume before switching off the unit power or the ignition key. The unit remembers its last volume setting. If you switch the power off with the volume up, when you switch the power back on, the sudden loud volume may hurt your hearing and damage the unit.

### Turning on/off the power

#### Note:

- Be careful about using this unit for a long time without running the engine. If you drain the car's battery too far, you may not be able to start the engine and this can reduce the service life of the battery.

1. Press the [FNC] button.
2. The illumination and display on the unit light up. The unit automatically remembers its last operation mode and will automatically switch to display that mode.
3. Press and hold the [FNC] button for 1 second or longer to turn off the power for the unit.

### Selecting a mode

1. Press the [FNC] button to change the operation mode.
2. Each time you press the [FNC] button, the operation mode changes in the following order:  
Radio mode → CD mode → Radio mode...

#### Note:

- If the CD mode is selected when no disc is inserted, the display shows "no DISC".

### Adjusting the volume

Turning the [ROTARY] knob clockwise increases the volume; turning it counterclockwise decreases the volume.

- \* The volume level is from 0 (minimum) to 33 (maximum).

### Setting the Z-Enhancer

This unit are provided with 3 types of sound tone effects stored in memory. Select the one you prefer.

- \* The factory default setting is "Z-EHCR OFF".

Each time you press the [Z-ENCR] button, the tone effect changes in the following order:

"Z-ENHANCER 1" → "Z-ENHANCER 2" → "Z-ENHANCER 3" → "Z-EHCR OFF" → "Z-ENHANCER 1"...

- Z-ENHANCER 1 : bass emphasized
- Z-ENHANCER 2 : treble emphasized
- Z-ENHANCER 3 : bass and treble emphasized
- Z-EHCR OFF : no sound effect

### Audio Mode Adjustments

Press the [A-M] button to select the adjustment mode. The mode switches as follows each time the [A-M] button is pressed:

**BASS → TREB → BAL → FAD → Previous mode**

- \* The display returns to the previous mode 7 seconds after the adjustment.

## Basic Operations

### Adjusting the bass

1. Press the **[A-M]** button and select “**BASS**”.
2. Turning the **[ROTARY]** knob clockwise emphasizes the bass; turning it counterclockwise attenuates the bass.
  - \* The factory default setting is “**0**”. (Adjustment range: -7 to +7)

### Adjusting the treble

1. Press the **[A-M]** button and select “**TREB**”.
2. Turning the **[ROTARY]** knob clockwise emphasizes the treble; turning it counterclockwise attenuates the treble.
  - \* The factory default setting is “**0**”. (Adjustment range: -7 to +7)

### Adjusting the balance

1. Press the **[A-M]** button and select “**BAL**”.
2. Turning the **[ROTARY]** knob clockwise emphasizes the sound from the right speaker; turning it counterclockwise emphasizes the sound from the left speaker.
  - \* The factory default setting is “**0**”. (Adjustment range: L13 to R13)

### Adjusting the fader

1. Press the **[A-M]** button and select “**FAD**”.
2. Turning the **[ROTARY]** knob clockwise emphasizes the sound from the front speakers; turning it counterclockwise emphasizes the sound from the rear speakers.
  - \* The factory default setting is “**0**”. (Adjustment range: F12 to R12)

#### Note:

- Bass and Treble can only be adjusted when the “**Z-enhancer**” is off.

### Turning on/off MAGNA BASS EX

To adjust the MAGNA BASS EX

The MAGNA BASS EX does not adjust the low sound area like the normal sound adjustment function, but emphasizes the deep bass sound area to provide you with a dynamic sound.

- \* The factory default setting is off. Press and hold the **[A-M]** button for 2 second or longer to turn the MAGNA BASS EX and “**M-B EX**” in the display lights on or off.

### Turning the screen saver function on or off

This unit is provided with the screen saver function. You can turn on or off this function.

If the button operation is performed with the screen saver function on, the operation display corresponding to the button operation is shown for about 30 seconds and the display returns to the screen saver display.

- \* The factory default setting is on.

Press the **[SS]** button while keeping the **[BND]** button pressed, to turn the screen saver function on or off.

### Switching the Clock Display

Press and hold the **[BND]** button, and then press the **[DISP]** button to switch between the operation mode and the clock display.

### Setting the Clock

1. Press and hold the **[BND]** button, and then press the **[DISP]** button to display the clock display.
2. Press and hold the **[BND]** button, and then press the **[DISP]** button for 2 seconds or longer.
3. Press the **[◀◀]** or **[▶▶]** button to toggle HOUR and MINUTE selection. Then turn the **[ROTARY]** knob clockwise to increase hour / minute or counterclockwise to decrease hour / minute.
4. Press the **[BND]** button, then clock is set.

#### Note:

- If you select another operation mode while you are setting the clock, the clock setting operation will be canceled.
- If you remove the vehicle's battery for a check or repair, the clock will be reset, so you must set it again.

### Illumination dimmer function

When the illumination line of this unit is connected with the car-side illumination signal line, the display illumination of this unit dims in connection with turning on the car-side illumination.

# Radio Mode Operations

## FM Reception

For enhanced FM performance the **MAGI-TUNE®** tuner includes signal actuated stereo control and multipath noise reduction circuits.

### Listening to the radio

1. Press the **[FNC]** button and select the radio mode. then the radio will be on.
2. To select a preset band, press the **[BND]** button, then select one of the preset bands such as FM1, FM2, FM3 or AM. Every time the **[BND]** button is pressed, the display will change as:  
FM1 → FM2 → FM3 → AM → FM1
3. Press the **[◀◀]** or **[▶▶]** button to tune in the desired station.

### Manual Tuning

1. Press the **[BND]** button to select the desired band FM1, FM2, FM3 or AM.
2. Press and hold the **[BND]** button for 2 seconds or longer, then the **"MANU"** is lit in the display, which means that a manual selection function is on.
3. Press the **[◀◀]** or **[▶▶]** button to manually tune in a station.

### Seek Tuning

1. Press the **[BND]** button to select the desired band FM1, FM2, FM3 or AM.
2. If the **"MANU"** is lit in the display, press and hold the **[BND]** button for 2 seconds or longer. When the **"MANU"** display is off, the seek tuning is now available.
3. Press the **[◀◀]** or **[▶▶]** button to automatically seek in a station.

### Preset Memory Function

Preset Memory Function can store up to 24 stations: six stations for each of FM1, FM2, FM3 and AM.

### Manual memory function

1. Press the **[BND]** button, to select a band you want to store in the memory.
2. Press the **[◀◀]** or **[▶▶]** button to tune into a desired station.
3. Press and hold one of the **[DIRECT]** button for 2 seconds or longer to store the current station into preset memory.

### Auto store function (Automatic Station Store)

1. Press **[BND]** button to select the desired band FM1, FM2, FM3 or AM.
2. Press and hold the **[PS/AS]** button for 2 seconds or longer. The stations at which the reception is the strongest will be automatically stored in the memory.

#### Notes:

- When the auto store is performed, the station previously store in the memory at that position is overwritten.
- When the number of stations stored is less than six, the previous content of the memory for each direct button will be retained.

### Preset Scanning (Preset Station Scan)

When the **[PS/AS]** button is pressed, the **"SCN"** will be indicated with preset memory numbers and the stations are tuned in for 7 seconds each in the order in which they were stored. Press the **[PS/AS]** button again to cancel the preset scanning mode.

### Instant Station Recall (ISR)

With this function, a specific radio station can be recalled from any mode.

#### ISR memory

1. Press the **[FNC]** button, then select the radio mode.
2. Select the radio station which you want to store in the memory.
3. Press and hold the **[ISR]** button for 2 sec-

onds or longer.

## Recalling ISR

Press the **[ISR]** button and the display will show "ISR". Then the radio station previously memorized will be selected. Press the **[ISR]** button again to disengage the unit from the Recalling ISR function.

## Area Change

Use this function when you are using the car stereo anywhere outside the U.S.

## Switchable frequency spacing

This car stereo is initially set to tune in frequency intervals of 10 kHz for AM and 200 kHz for FM, the standard calibrations inside the U.S. When using the unit outside the U.S., use the following procedure to switch the frequency range.

		Initial Setting (U.S. Standard)	New Setting (outside U.S.)
<b>AM</b>	Frequency spacing	10 kHz	9 kHz
	Frequency range	530 to 1,710 kHz	531 to 1,629 kHz
<b>FM</b>	Frequency spacing	200 kHz	50 kHz
	Frequency range	87.9 to 107.9 MHz	87.0 to 108 MHz

The table below lists the frequency specifications for the U.S. and other countries.

## Switching the area change Outside U.S. (New Setting)

While pressing the **[AM]** button, press the **[RPT]** button, then "outside U.S." will be selected.

## Inside U.S. standard (Initial Setting)

While pressing the **[AM]** button, press the **[SCN]** button, then the "U.S. standard" will be selected.

## Loading a CD

Insert a CD into the center of the CD insertion slot with the labeled side facing up. "LOAD" appears in the display, the CD enters into the slot and start playing.

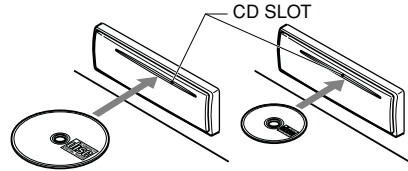

## Notes:

- Do not put your hand, fingers, or foreign objects into the CD insertion slot.
- If a CD has already been loaded, another CD cannot be inserted. Do not insert another one forcefully.
- Discs not bearing the  mark cannot be played with the unit. CD-ROMs cannot be played.
- Some CDs recorded in CD-R/CD-RW mode may not be usable.

## Listening to the Disc already Inserted

Press the **[FNC]** button to select the CD mode, the CD will start playing.

## Stopping (pausing) Playback

While the CD playing pressing the **[▶/||]** button will stop the CD and "PAUSE" indicate.

Press the **[▶/||]** button again to resume playback.

## Ejecting the CD

Press the **[▲]** button, then the CD will be ejected.

## Note:

- If the ejected CD is left as it is, it will be reloaded after 15 seconds.
- However, single CDs will not be reloaded, so make sure to remove them.

## Top Function

Press the **[BND]** button, then the CD will start playing from the first song (track number 1).

## CD Mode Operations

---

### Selecting Tracks (songs)

Press the [◀◀] or [▶▶] button.

- ▶▶: Playback will start from the next track.
- ◀◀: Playback will start from the beginning of the track currently playing. When this button is pressed again, the CD will play from the previous track.

### Fast-Forward and Fast-Backward

Press and hold the [◀◀] or [▶▶] button.

- ▶▶: To fast-forward
- ◀◀: To fast-backward

\* Pressing the [◀◀] or [▶▶] button for 1 second or longer will move forward or backward 3 times faster than normal play, and pressing it for 3 seconds or longer will do the operation 30 times faster.

### Scan Play (Intro Music Scan)

At Audio CD press the [SCN] button, then the "SCN" in the display lights on, then the CD will play the first 10 seconds of each track of the whole disc. Press the [SCN] button again to disengage the unit from scan play.

\* A scan play will start from the track following the one currently playing.

### Repeat Play

At Audio CD press the [RPT] button, then the "RPT" in the display lights on, then the track currently playing will be played repeatedly. Press the [RPT] button again to disengage the unit from repeat play.

### Random Play

At Audio CD press the [RDM] button, then the "RDM" in the display lights on, then the entire tracks on the disc will be played at random. Press the [RDM] button again to disengage the unit from random play.

# 9. TROUBLESHOOTING

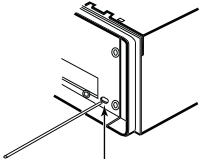
Problem	Cause	Solution
Power does not turn on. (No sound is produced.)	Fuse is blown.	Replace with a fuse of the same amperage. If the fuse blows again, consult your store of purchase.
	Incorrect wiring.	Consult your store of purchase.
Compact disc cannot be loaded.	Another compact disc is already loaded.	Eject the compact disc before loading the new one.
Sound skips or is noisy.	Compact disc is dirty.	Clean the compact disc with a soft cloth.
	Compact disc is heavily scratched or warped.	Replace with a compact disc with no scratches.
Sound is bad directly after power is turned on.	Water droplets may form on the internal lens when the car is parked in a humid place.	Let dry for about 1 hour with the power on.
Nothing happens when button are pressed. Display is not accurate.	The microprocessor has malfunctioned due to noise, etc.	Turn off the power, then press the <b>[RELEASE]</b> button and remove the DCP. Press the reset button for about 2 seconds with a thin rod. 
	DCP or main unit connectors are dirty.	Wipe the dirt off with a soft cloth moistened with cleaning alcohol.

# 10. ERROR DISPLAYS

- To protect the system, this unit has been equipped with self diagnostic functions. If a fault arises, a warning is issued by various error displays. Follow the corrective measures and remove the fault.

Error Display	Corrective Measure
<b>ERROR 2</b>	This error display indicates that a fault has arisen in the mechanism of the source unit (for example, the disc cannot be ejected). → Check the source unit.
<b>ERROR 3</b>	This error display indicates that the pickup focus is off because of a scratched disc or some other factor during source unit play. → Check the compact disc.
<b>ERROR 6</b>	This indicates that the CD's TOC (table of contents) cannot be read, for example because the selected disc is upside-down.

# 11. SPECIFICATIONS

## FM Tuner

Frequency Range: 87.9 MHz to 107.9 MHz  
 Usable Sensitivity: 11 dBf  
 50 dB Quieting Sensitivity: 17 dBf  
 Alternate Channel Selectivity: 75 dB  
 Stereo Separation (1 kHz): 35 dB  
 Frequency Response ( $\pm 3$  dB): 30 Hz to 15 kHz

## AM Tuner

Frequency Range:  
 AM 530 kHz to 1,710 kHz  
 Usable Sensitivity: 25  $\mu$ V

## CD Player

System: Compact disc audio system  
 Usable Discs: Compact disc  
 Frequency Response: 10 Hz to 20 kHz ( $\pm 1$  dB)  
 Signal-to-Noise Ratio: 100 dB (1 kHz) IHF-A  
 Dynamic Range: 95 dB (1 kHz)  
 Harmonic Distortion: 0.01%

## Audio

Maximum Power Output: 200 W (50 W  $\times$  4 ch)  
 Continuous Average Power Output:  
 17 W  $\times$  4, into 4  $\Omega$ , 20 Hz to 20 kHz, 1% THD  
 Bass Control Action (30 Hz):  $\pm 14$  dB  
 Treble Control Action (10 kHz):  $\pm 14$  dB  
 Line Output (with A/C 1 kHz, 10 k $\Omega$ ): 1.7 V

## General

Power Supply Voltage:  
 14.4 V DC (10.8 V to 15.6 V allowable),  
 negative ground  
 Current Consumption: Less than 15 A  
 Speaker Impedance: 4  $\Omega$  (4  $\Omega$  to 8  $\Omega$  allowable)  
 Weight: 2.42 lb. (1.1 kg)  
 Dimensions:  
 7" (Width)  $\times$  1-15/16" (Height)  $\times$  6" (Depth)  
 178 (W)  $\times$  50 (H)  $\times$  152 (D) mm

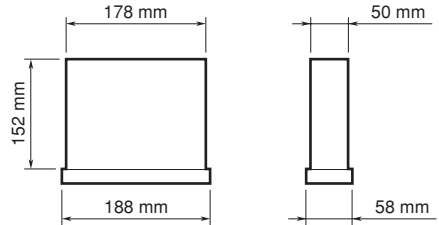

### Notes:

- Specifications comply with JEITA Standards.
- Specifications and design are subject to change without notice for further improvement.
- Please make sure when connecting external power amplifier, that you properly, to the car chassis, ground the amplifier.
- If this is not done, severe damage to the source unit may happen.