



INSTALLATION INSTRUCTIONS

FOR Model : 33203

WARNING! SHUT POWER OFF AT FUSE OR CIRCUIT BREAKER.

HANGING THE FIXTURE(Fig.1)

- 1.Shut off the power at the circuit breaker and remove old fixture,including the crossbar.
- 2.Carefully unpack your new fixture and lay out all the parts on a clear area.Take care not to lose any small parts necessary for installation.
- 3.Screw the center nipple(C) on the crossbar(A),and firm it using the hex nuts.
- 4.Attach the crossbar(A) to the Outlet Box by using 2 Outlet Box Screws(B).
- 5.Thread the center nipple(M) on the coupling of the fixture(L)
- 6.Attach the top frame(N) onto the center nipple(M),then firm it using the fixture loop(P) and hex nut(O)
- 7.Thread the center nipple(I) on the coupling of the fixture(L).
- 8.Attach the decorative column(H) onto the center nipple(I),then firm it using the finial(G)
- 9.Connecting the wires(Fig.2)

Connect the black wire from the fixture to the black house (hot) wire .Connect the white wire from the fixture to the white (neutral) house wire .Make sure all wire nuts are secured .You may wrap the connections with electrical tape.If your outlet has a ground wire (green or bare copper), connect fixture's ground wire to it. Otherwise, connect fixture's ground wire directly to the crossbar using the green screw provided. Tuck the wire connections neatly into the junction box.

- 10.Attach the glass shade(J) on the fixture using the socket ring(K).
- 11.Install bulb.(Type A-19, not supplied.)
- 12.Mount the canopy(D) against the wall, and firm it using the loop ring(E).
- 13.Turn on the power at fuse or circuit box.

DO NOT EXCEED THE MAXIMUM WATTAFE RATING!

Your installation is now complete.Return power to the junction box and test the fixture.

Fig.1

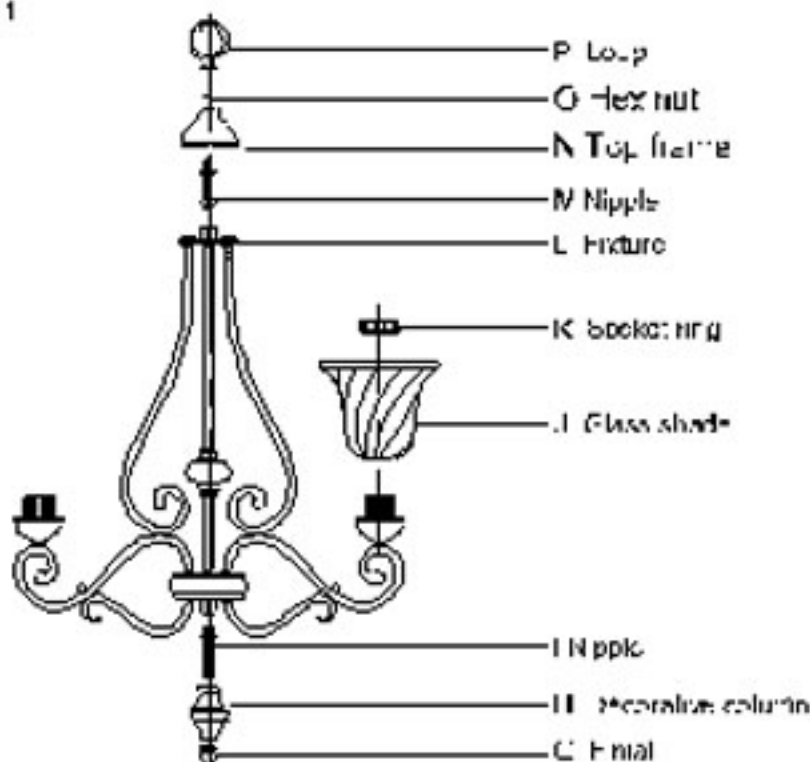

Fig.3

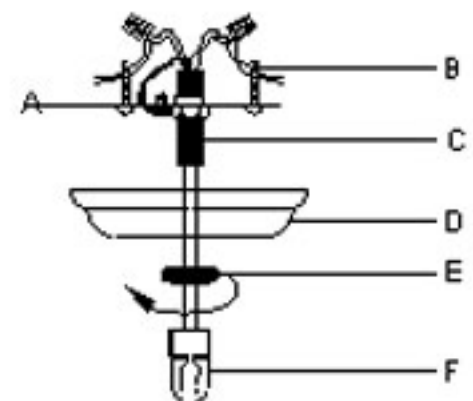

Fig.2

