

# iHome®

iBN180

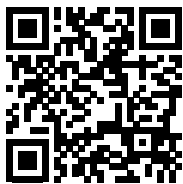

***NFC Bluetooth  
FM Clock Radio  
with USB Charging***



instruction manual

# iBN180

## Introduction

Thank you for purchasing the iHome iBN180. This product is designed to provide high quality wireless sound from your iPad, iPhone, iPod or other Bluetooth audio device.

Along with the included Quick Bluetooth Connection Guide this instruction booklet explains the basic operation and care of the unit. Please read them carefully and keep for future reference.

This unit features NFC (Near Field Communication) technology which allows you to wirelessly connect your NFC-enabled device to instantly 'pair and play'. See your device's user manual for details on how to interact with NFC devices. If your Bluetooth device does not support NFC, you can pair it manually with this unit.

## Maintenance

- Place the unit on a level surface away from sources of direct sunlight or excessive heat.
- Protect your furniture when placing your unit on a natural wood and lacquered finish. A cloth or other protective material should be placed between it and the furniture.
- Clean your unit with a soft cloth moistened only with mild soap and water. Stronger cleaning agents, such as thinner or similar materials can damage the surface of the unit.

# FCC Information

# iBN180

## FCC Radiation Exposure Statement

FCC ID: EMOIBN180  
IC: 986B-IBN180

This equipment complies with FCC RF radiation exposure limits set forth for an uncontrolled environment.

This device complies with Part 15 of the FCC Rules, operation is subject to the following two conditions: (1) This device may not cause harmful interference, and (2) this device must accept any interference received, including interference that may cause undesired operation.

- Warning: Changes or modifications to this unit not expressly approved by the party responsible for compliance could void the user's authority to operate the equipment.
- NOTE: This equipment has been tested and found to comply with the limits for a Class B digital device, pursuant to Part 15 of the FCC Rules.

These limits are designed to provide reasonable protection against harmful interference in a residential installation. This equipment generates, uses and can radiate radio frequency energy and, if not installed and used in accordance with the instructions, may cause harmful interference to radio communications. However, there is no guarantee that interference will not occur in a particular installation. If this equipment does cause harmful interference to radio or television reception, which can be determined by turning the equipment off and on, the user is encouraged to try to correct the interference by one or more of the following measures:

- Reorient or relocate the receiving antenna.
- Increase the separation between the equipment and receiver.
- Connect the equipment into an outlet on a circuit different from that to which the receiver is connected.
- Consult the dealer or an experienced radio/TV technician for help.

CAN ICES-3 (B)/NMB-3(B)

## IC Statement

This device complies with Industry Canada RSS-210. Operation is subject to the following two conditions: (1) this device may not cause interference, and (2) this device must accept any interference, including interference that may cause undesired operation of the device.

**Le présent appareil est conforme aux CNR d'Industrie Canada applicables aux appareils radio RSS-210. L'exploitation est autorisée aux deux conditions suivantes : (1) l'appareil ne doit pas produire de brouillage, et (2) l'utilisateur de l'appareil doit accepter tout brouillage radioélectrique subi, même si le brouillage est susceptible d'en compromettre le fonctionnement.**

The device meets the exemption from the routine evaluation limits in section 2.5 of RSS 102 and compliance with RSS-102 RF exposure, users can obtain Canadian information on RF exposure and compliance.

**Le dispositif rencontre l'exemption des limites courantes d'évaluation dans la section 2.5 de RSS 102 et la conformité à l'exposition de RSS-102 rf, utilisateurs peut obtenir l'information canadienne sur l'exposition et la conformité de rf.**

## Table of Contents

|   |    |
|---|----|
| Meet Your iBN180.....   | 5  |
| The Display/Setting Up the Unit.....                                | 6  |
| Replacing/Installing Backup Batteries.....                          | 7  |
| Setting the Clock/ FM Radio.....                                    | 8  |
| Setting and Using FM Presets/Using FM Radio in Other Countries..... | 9  |
| Setting and Using the Alarm.....                                    | 10 |
| Previewing Alarms and Turning Alarms On/Off.....                    | 11 |
| Off/Snooze/Dimmer Button/Sleep Mode.....                            | 11 |
| Using Bluetooth: Pairing & Playing Your Device Using NFC.....       | 12 |
| Pairing Your Device Using Standard Bluetooth.....                   | 13 |
| Pairing with a Different Device.....                                | 13 |
| Playing Audio Via Bluetooth/Playing Audio Via Aux-in.....           | 14 |
| Charging Devices via USB Port.....                                  | 15 |
| Troubleshooting.....  | 16 |
| Consumer Product Safety Guide.....                                  | 17 |
| Warranty.....   | 18 |

# iBN180

## Included

- iBN180 system
- 100V-240V universal AC adaptor
- 12 inch audio cable

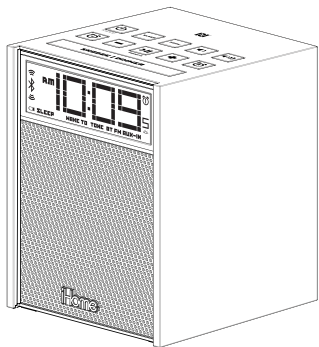

iBN180



AC adaptor

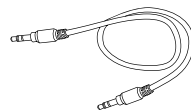

12 inch audio cable

# iBN180

## Meet Your iBN180

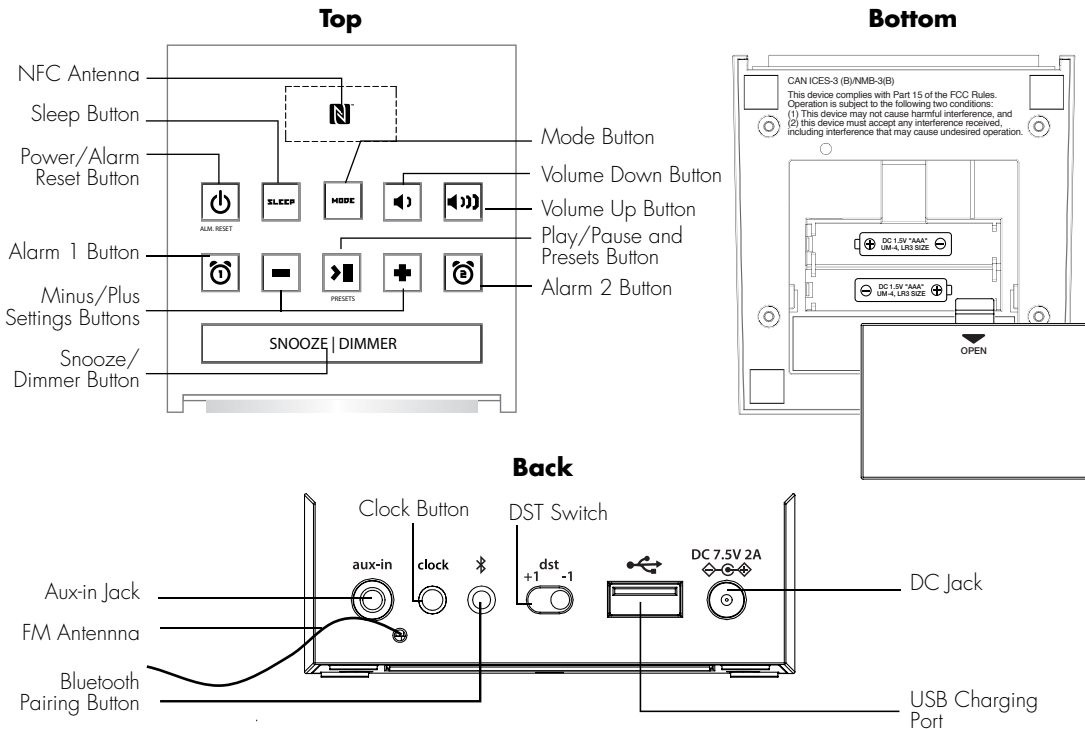

# Using the iBN180

## The Display

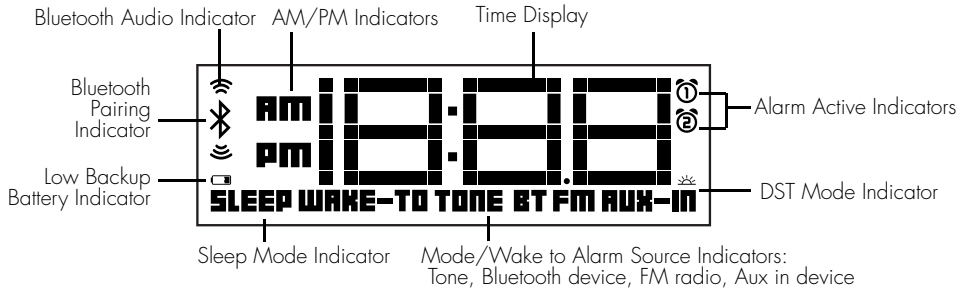

## Setting Up the Unit

Connect the included AC adaptor to the DC jack located on the back of the unit and connect the other end to a working wall outlet. To turn unit on press and release the **Button**.

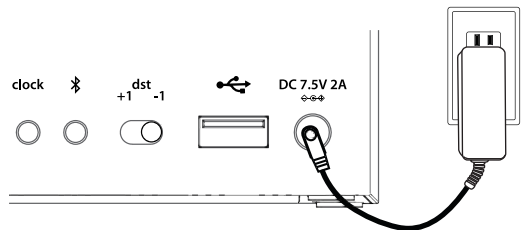

# Using the iBN180

## Replacing and Installing Clock Backup Batteries

**Note: 2 AAA batteries are included with the unit. Install them before using the unit.**

This model is equipped with a battery backup circuit that will maintain the time and alarm time settings in the event of a temporary power interruption (the display is NOT maintained). The battery backup circuit will also operate the buzzer alarm to wake you up at the selected wake up time even if the power is out. When the backup batteries are getting weak the Low Backup Battery Indicator will begin flashing in the display. When you see this flashing indicator you should replace the backup batteries as soon as possible. Note: We recommend alkaline batteries for best performance.

### To install/replace the backup batteries:

**IMPORTANT:** When replacing the backup batteries be sure to have the unit connected to the AC outlet to maintain all of your settings, otherwise it will be necessary to reset the time and alarm time after the batteries are replaced.

1. Slide and remove the battery door located on the bottom of the unit. If replacing batteries, remove the exhausted batteries.
2. Insert 2 fresh AAA batteries in the backup battery compartment. Make sure the polarity of the batteries ("+" or "-" nodes) matches the illustration.
3. Slide and close the battery compartment door. Confirm that the backup battery indicator is not flashing in the display.

**Note:** Make sure you dispose of batteries properly (see your local regulations)

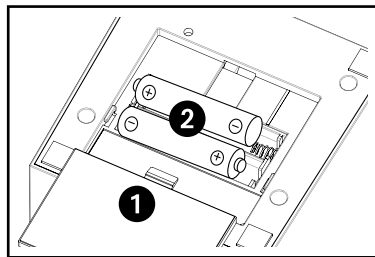

### Battery Warning

- Do not heat above 75°C (167°F)
- Do not open batteries
- Do not install backwards
- Do not expose contents to water
- Do not dispose of in fire



# Using the iBN180

## Setting the Clock

The unit features a Daylight Saving Time (DST) Switch on the back of the unit to quickly add or subtract an hour to account for Daylight Saving Time and Standard Time differences. Before setting the time, move the **DST Switch** to **+1** to add an hour or to **-1** to subtract an hour.

1. Press and hold the **Clock Button** for 2 seconds until the clock display flashes and a beep sounds.
2. Press the **-** or **+** **Buttons** to adjust the clock to the current time (hold for rapid setting).  
Make sure you set the correct AM/PM time. The AM and PM indicators appear to the left of the display.
3. To toggle the clock display between standard 12 hour time and 24 hour ("military") time display, press the **▶||** **Button** during time setting while time digits are flashing.
4. Press the **Clock Button** to confirm the time and exit clock setting mode. 2 beeps will confirm clock setting is complete.

## FM Radio

1. Press and release the **Mode Button** as needed until the FM indicator icon and current FM radio station appear on the display.
2. Press the **-** or **+** **Buttons** to tune the radio to the desired station (hold to scan for the next clear station).  
Extend the FM antenna for best reception.
3. Press the **🔊** or **🔊)🔊** **Buttons** to adjust the volume on the unit.
4. When you are through listening, press the **🔌** **Button** to turn the unit off.

# Using the iBN180

## Setting and Using FM Presets

The unit allows you to store up to 6 FM radio station presets

1. Press the **⏻ Button** on the unit to turn it on.
2. Press and release the **Mode Button** as needed until the FM indicator icon and current FM radio frequency appear on the display.
3. Press and release the **▶|| Presets Button** as needed until the preset number (P1- P6) you wish to set is displayed, then *press and hold* the **▶|| Presets Button** to enter setting mode.
4. Press the **-** or **+** **Buttons** to tune the radio to the desired station (hold to scan for the next clear station).
5. Press and release the **▶|| Presets Button** to confirm. 2 beeps will sound to confirm the preset has been assigned. Continue steps 3 - 5 until you have set up to 6 preset stations.
6. To listen to a preset FM station at any time, follow steps 1 - 3 to turn on FM radio mode and cycle to the desired preset. NOTE: If no Bluetooth device is linked/paired, pressing the **▶|| Presets Button** when the unit is OFF will turn the unit ON in the last active mode.

## Using FM Radio in Other Countries

Different areas of the world use different FM frequency steps and ranges. By default, this unit is set to USA frequency steps. To use the radio outside the USA:

1. Make sure unit is OFF.
2. Press and hold the **Mode Button** until "USA" flashes in the display.
3. Press and release **-** or **+** **Buttons** to cycle your location: Europe, Japan, Australia, China or USA.
4. Press the **Mode Button** again to exit frequency setting mode. 2 beeps will confirm setting.

# Using the iBN180

## Setting and Using the Alarms

This unit has 2 separate alarms, each set the same way. Below we explain how to set Alarm 1. To set alarm 2, follow the same steps using the Alarm 2 Button.

**Note:** each step must be completed while display is flashing or step will time-out with any changes saved.

1. Press and hold the **Alarm 1 Button** for 2 seconds until the time display and alarm icon flash.
2. Press the **-** or **+** **Buttons** to adjust the alarm time to the desired time (hold for rapid setting).  
Make sure you set the correct AM/PM alarm time. The AM and PM indicators appear on the left of the display.
3. Press the **Alarm 1 Button** to confirm the alarm time setting. The **wake-to** source will flash.
4. Press the **-** or **+** **Buttons** to select the desired wake to alarm source: Bluetooth, radio or tone.

**Wake to Bluetooth:** You will wake to the currently linked Bluetooth device. If no device is detected, the alarm will default to current Tone.

**Wake to Radio:** Press the **Alarm 1 Button** to confirm. Press the **▶▶ Presets Button** to select an FM preset to wake to, or press the **-** or **+** **Buttons** to tune in a desired wake to station.

**Wake to Tone:** Press the **Alarm 1 Button** to confirm. Press the **-** or **+** **Buttons** to select one of the four built-in wake-to tones.

5. Press the **Alarm 1 Button** to confirm the alarm source. The volume display will flash.
6. Press the **◀** or **▶** **Buttons** to adjust the alarm volume on the unit from 05 - 40. Note that the alarm volume setting is stored separately from other volume settings.
7. Press the **Alarm 1 Button** to confirm the alarm settings and exit alarm setting mode. 2 beeps will confirm clock setting is complete. The alarm icon will remain on the display, indicating the alarm is armed.

# Using the iBN180

## Previewing Alarms and Turning Alarms On/Off

1. Press and release the **Alarm Button** to view the current alarm time.
2. Press and release the **Alarm Button** as needed to toggle the alarm ON and OFF, indicated by the alarm icon.

## Snooze/Dimmer Button

1. To program Snooze, press and hold the **Snooze/Dimmer Button** during normal operation (when no alarm is sounding).
2. Press the **-** or **+** **Buttons** to select the desired snooze time (between 01 and 29 minutes).
3. Press and release the **Snooze/Dimmer Button** to confirm Snooze setting
4. While the alarm is sounding, press and release the **Snooze/Dimmer Button** to temporarily silence the alarm for the set duration (9 minutes is the default). Snooze can be used several times during alarm.
5. To adjust the brightness of the display, press and release the **Snooze/Dimmer Button** during normal operation (when no alarm is sounding) to cycle through the brightness display settings.

**NOTE: Snooze function is disabled when operating on battery backup.**

## Sleep Mode

This unit allows you to sleep or nap to the current sound source.



1. To set Sleep time, press and release the **Sleep Button** as needed to cycle to the desired sleep duration: 120, 90, 60, 30 or 15 minutes or OFF (turns the unit off).
2. Press the **⏮** or **⏭** **Buttons** to adjust the sleep volume on the unit. Note that the sleep volume setting is stored separately from other volume settings.

# Using the iBN180

## Using Bluetooth:

### Pairing and Playing Your Device Using NFC

This unit features wireless NFC pairing, which allows playing NFC-enabled devices to pair and play instantly. For pairing non-NFC devices, please see the following section “Pairing Your Device Using Standard Bluetooth”.

1. Turn on your Bluetooth-enabled/NFC-enabled device and turn on both Bluetooth capability and NFC capability as described in the device’s user manual.
2. Place your NFC-enabled device in play mode.
3. Touch the NFC area of your playing device against the NFC antenna on top of the unit. The unit will turn on and enter automatic pairing mode, tones will sound and Bluetooth indicator icon will flash while the unit attempts to pair. “iHome iBN180” should appear on your device’s menu. Once paired with a device, the Bluetooth indicator on the display will stop flashing, then the Bluetooth icon will remain and a confirmation tone will sound and your music will play through the unit.
4. Use the controls on your device to play or pause audio and navigate tracks.
5. Keep the volume on your device to at least 50%. Press the  or  **Buttons** to adjust the volume on the unit.
6. When done listening, press the  **Button** to turn the unit OFF. Remember to turn off your audio device, too.

**NOTE:** To disconnect your device, simply touch it again on the NFC antenna on top of the unit. To pair a device manually, please see the following “Pairing Your Device Using Standard Bluetooth” section.

# Using the iBN180

## Pairing Your Device Using Standard Bluetooth

1. Turn on your Bluetooth-enabled device and turn on Bluetooth capability as described in the device's user manual.
2. Press and hold the **Pairing Button** on the back of the unit for 2 seconds until the Bluetooth icon flashes on the display and a beep sounds, indicating pairing attempt. "iHome iBN180" should appear on your device's menu. If "Not Paired", "Not Connected" or similar message appears, select "iHome iBN180" on the device to connect it. If your device asks for a password, enter **1234** on the keyboard of your device. If no device is paired within 2 minutes, a tone will sound and the unit will revert to its previous mode. To retry pairing, turn the unit OFF then back ON, then follow step 2 again.
3. Once paired with a device, the **Bluetooth** indicator on the display will stop flashing then the Bluetooth icon will remain. On some devices, you must then select "Use as Audio Device" or similar on the device's Bluetooth menu. Once paired, your device should link to the iBN180 whenever within range (about 30 feet).

## Pairing with a Different Device

When you power ON the unit, it will automatically link with the previously paired Bluetooth device as long as that device is still within range (about 30 feet). To pair with a different device follow steps 1-2.

# Using the iBN180

## Playing Audio Via Bluetooth

1. Press the **⏻ Button** to turn the unit ON.
2. Press and release the **Mode Button** as needed until the Bluetooth indicator icon appears on the display.
3. Adjust the volume output on your device to at least 50%. Press the **▶|| Play Pause Button** on the unit to play audio from your linked Bluetooth device. In a few moments the Bluetooth wave icons will appear, indicating Bluetooth streaming mode. 
4. Press the **-** or **+ Buttons** to go to the previous or next track.
5. Press the **◀** or **▶ Buttons** to adjust the volume on the unit.
6. When done listening, press the **⏻ Button** to turn the unit off. Remember to turn off your audio device, too.

## Playing Audio via Aux-In

1. Connect one end of the included standard stereo 3.5mm audio cable into the aux-in jack on the back of the unit and the other end into the headphone or output jack of your audio device.
2. Press the **⏻ Button** on the unit to turn it on.
3. Press and release the **Mode Button** as needed until the AUX indicator icon appears on the display.
4. Power on your device and place in play mode. Adjust the volume output on the device to at least 50%.
5. Press the **◀** or **▶ Buttons** to adjust the volume on the unit.
6. When done listening, press the **⏻ Button** to turn the unit off. Remember to turn off your audio device, too.

# Using the iBN1 80

## Charging Devices via USB Port

1. Connect the standard size end of a USB cable (not included) to the USB Port on back of the unit and connect the other end to the charging port on your device.
2. Monitor the charging on your device. Some devices use a proprietary charging method and will not charge using the USB Port. If this happens, you must charge your device using the charger that came with it.

NOTE: unit must be plugged into working outlet to charge devices

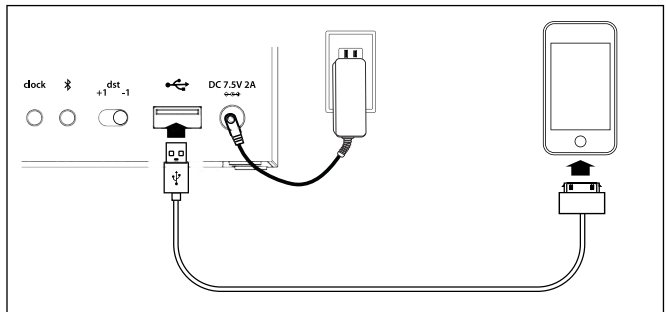



## Unit doesn't respond

- Check that all connections are correct and properly plugged in.
- Only use the AC adaptor that came with the unit
- Make sure your device is properly paired with the iBN180.
- Make sure the **Power** is ON.

## Unit doesn't respond (locked up or frozen)

- The unit may need to be reset. To do so, unplug the unit from power source and remove the backup batteries. Let unit stand for 2 minutes. Re-install backup batteries and connect unit to power source. You will need to reset the clock, radio, and any other settings.

## Reset/clear paired Bluetooth devices from unit

- To clear all paired Bluetooth devices from the unit, press and hold the **Pairing Button** on the back of the unit for 10 seconds.

## Trouble pairing device with iBN180

Bluetooth implementation varies depending on your device's hardware and operating system. Please see [www.ihome.com/support](http://www.ihome.com/support) for updates on pairing.

- When you power ON the unit, it will automatically link with the last previously paired Bluetooth device if the device is still within range (about 30 feet). When device is out of range, the Bluetooth icon will appear for 2 minutes as the unit attempts to relink. To pair with a different device you must turn off Bluetooth capability on the already paired device, or take it out of range.
- Make sure your device is working properly. Check your device's manual for details on Bluetooth pairing and linking.

For further information and to see the latest instructions, visit [www.ihome.com/support](http://www.ihome.com/support)

# Consumer Product Safety Guide

## IMPORTANT SAFETY INSTRUCTIONS

When used in the directed manner, this unit has been designed and manufactured to ensure your personal safety. However, improper use can result in potential electrical shock or fire hazards. Please read all safety and operating instructions carefully before installation and use, and keep these instructions handy for future reference. Take special note of all warnings listed in these instructions and on the unit.

1. **Water and Moisture** – The unit should not be used near water. For example: near a bathtub, washbowl, kitchen sink, laundry tub, swimming pool or in a wet basement.
2. **Ventilation** – The unit should be situated so that its location or position does not interfere with its proper ventilation. For example, it should not be situated on a bed, sofa, rug or similar surface that may block ventilation openings. Also, it should not be placed in a built-in installation, such as a bookcase or cabinet, which may impede the flow of air through the ventilation openings.
3. **Heat** – The unit should be situated away from heat sources such as radiators, heat registers, stoves or other appliances (including amplifiers) that produce heat.
4. **Power Sources** – The unit should be connected to a power supply only of the type described in the operating instructions or as marked on the appliance. Only use the AC adapter that came with the unit.
5. **Power-Cable Protection** – Power supply cables should be routed so that they are not likely to be walked on or pinched by items placed upon or against them. It is always best to have a clear area from where the cable exits the unit to where it is plugged into an AC socket.
6. **Cleaning** – The unit should be cleaned only using a warm damp cloth. Do not use solvents, etc.
7. **Objects and Liquid Entry** – Care should be taken so that objects do not fall and liquids are not spilled into any openings or vents located on the product.
8. **Attachments** – Do not use attachments not recommended by the product manufacturer.
9. **Lightning and Power Surge Protection** – Unplug the unit from the wall socket and disconnect the antenna or cable system during a lightning storm or when it is left unattended and unused for long periods of time. This will prevent damage to the product due to lightning and power-line surges.
10. **Overloading** – Do not overload wall sockets, extension cords, or integral convenience receptacles as this can result in a risk of fire or electric shock.
11. **Damage Requiring Service** – The unit should be serviced by qualified service personnel when:
  - A. the power supply cable or plug has been damaged.
  - B. objects have fallen into or liquid has been spilled into the enclosure.
  - C. the unit has been exposed to rain.
  - D. the unit has been dropped or the enclosure damaged.
  - E. the unit exhibits a marked change in performance or does not operate normally.
12. **Periods of Nonuse** – If the unit is to be left unused for an extended period of time, such as a month or longer, the backup batteries should be removed from the unit to prevent damage or corrosion.
13. **Servicing** – The user should not attempt to service the unit beyond those methods described in the user's operating instructions. Service methods not covered in the operating instructions should be referred to qualified service personnel.

Questions? Visit [www.ihome.com](http://www.ihome.com)  
or call 1-800-288-2792 Toll Free

# Limited 1 Year Warranty

iHome Products, a division of SDI Technologies Inc. (hereafter referred to as SDI), warrants this product to be free from defects in workmanship and materials, under normal use and conditions, for a period of one (1) year from the date of original purchase.

Should this product fail to function in a satisfactory manner, it is best to first return it to the store where it was originally purchased. Should this fail to resolve the matter and service still be required by reason of any defect or malfunction during the warranty period, SDI will repair or, at its discretion, replace this product without charge. This decision is subject to verification of the defect or malfunction upon delivery of this product to the Factory Service Center authorized by SDI Customer Service. The product must include proof of purchase, including date of purchase. An out-of-warranty fee for service will be charged for units that are received without proof of purchase.

Before returning this product for service, please first replace the batteries (if applicable) with fresh ones, as exhausted or defective batteries are the most common cause of problems encountered.

If service is still required:

1. Call SDI Customer Service at 1-800-288-2792 for Return Authorization and for the address of the Factory Service Center.
2. Remove the batteries (if applicable) and pack the unit in a well padded, heavy corrugated box. SDI is not responsible for damage that occurs during shipping to the Factory Service Center.
3. Enclose a photocopy of your sales receipt, credit card statement, or other proof of the date of purchase, if within the warranty period. Also include your name and address information, a brief description for why the unit is being returned, and the return authorization number. No unit can be processed without a return authorization number.
4. Write the return authorization number on the side of the shipping package and send the unit prepaid and insured to the Factory Service Center address authorized by SDI Customer Service.

## Disclaimer of Warranty

NOTE: This warranty is valid only if the product is used for the purpose for which it was designed. It does not cover (i) products which have been damaged by negligence or willful actions, misuse or accident, or which have been modified or repaired by unauthorized persons; (ii) cracked or broken cabinets, or units damaged by excessive heat; (iii) damage to digital media players, CD's or tape cassettes (if applicable); (iv) the cost of shipping this product to the Factory Service Center and its return to the owner.

This warranty is valid only in the United States of America and does not extend to owners of the product other than to the original purchaser.

In no event will SDI or any of its affiliates, contractors, resellers, their officers, directors, shareholders, members or agents be liable to you or any third party for any consequential or incidental damages, any lost profits, actual, exemplary or punitive damages. (Some states do not allow limitations on implied warranties or exclusion of consequential damages, so these restrictions may not apply to you.) This warranty gives you specific legal rights, and you may also have other rights which vary from state to state.

Your acknowledgment and agreement to fully and completely abide by the above mentioned disclaimer of warranty is contractually binding to you upon your transfer of currency (money order, cashier's check, or credit card) for purchase of your SDI product.

**© 2014 SDI Technologies, Inc. All rights reserved**  
**Questions? Visit [www.ihome.com](http://www.ihome.com)**  
**or call 1-800-288-2792 Toll Free**