



FM/MW/LW/RDS CD Receiver

CDA-9815RB

CDA-9813R

CDA-9812RB

CDA-9812RR

MP3



DAB CONTROL

EN

DE

FM/MW/LW/RDS CD Receiver

CDA-9811R

MP3



DAB CONTROL

FR

- **OWNER'S MANUAL**
Please read before using this equipment.
- **BEDIENUNGSANLEITUNG**
Lesen Sie diese Bedienungsanleitung bitte vor Gebrauch des Gerätes.
- **MODE D'EMPLOI**
Veuillez lire avant d'utiliser cet appareil.
- **MANUAL DE OPERACIÓN**
Léalo antes de utilizar este equipo.
- **ISTRUZIONI PER L'USO**
Si prega di leggere prima di utilizzare il attrezzatura.
- **ANVÄNDARHANDLEDNING**
Innan du använder utrustningen bör du läsa igenom denna användarhandledning.

ES

IT

ALPINE ELECTRONICS MARKETING, INC.
1-1-8 Nishi Gotanda,
Shinagawa-ku,
Tokyo 141-0031, Japan
Phone 03-5496-8231

ALPINE ELECTRONICS OF AMERICA, INC.
19145 Gramercy Place, Torrance,
California 90501, U.S.A.
Phone 1-800-ALPINE-1 (1-800-257-4631)

ALPINE ELECTRONICS OF CANADA, INC.
7300 Warden Ave., Suite 203, Markham,
Ontario L3R 9Z6, Canada
Phone 1-800-ALPINE-1 (1-800-257-4631)

ALPINE ELECTRONICS OF AUSTRALIA PTY. LTD.
6-8 Fiveways Boulevard Keysborough,
Victoria 3173, Australia
Phone 03-9769-0000

ALPINE ELECTRONICS GmbH
Kreuzerkamp 7,
40878 Ratingen, Germany
Phone 02102-4550

ALPINE ELECTRONICS OF U.K. LTD.
Alpine House
Fletchamstead Highway, Coventry CV4 9TW, U.K.
Phone 0870-33 33 763

ALPINE ELECTRONICS FRANCE S.A.R.L.
(RCS PONTOISE B 338 101 280)
98, Rue de la Belle Etoile, Z.I. Paris Nord II,
B.P. 50016, 95945 Roissy Charles de Gaulle
Cedex, France
Phone 01-48638989

ALPINE ITALIA S.p.A.
Viale C. Colombo 8, 20090 Trezzano Sul
Naviglio (MI), Italy
Phone 02-484781

ALPINE ELECTRONICS DE ESPAÑA, S.A.
Portal de Gamarra 36, Pabellón, 32
01013 Vitoria (Alava)-APDO 133, Spain
Phone 945-283588

SE

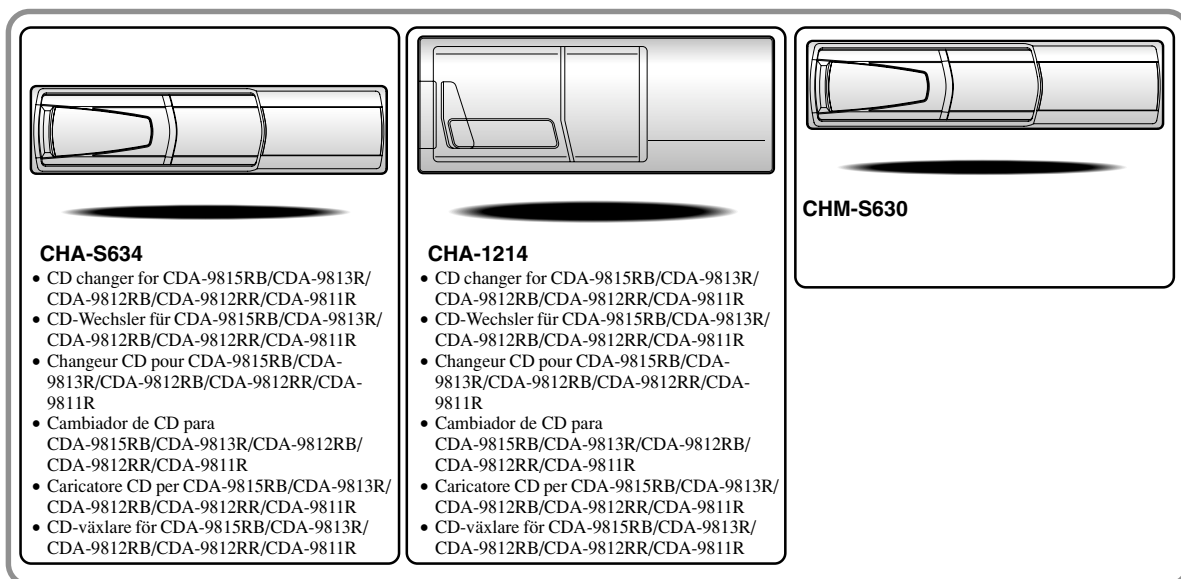

CHA-S634

- CD changer for CDA-9815RB/CDA-9813R/CDA-9812RB/CDA-9812RR/CDA-9811R
- CD-Wechsler für CDA-9815RB/CDA-9813R/CDA-9812RB/CDA-9812RR/CDA-9811R
- Changeur CD pour CDA-9815RB/CDA-9813R/CDA-9812RB/CDA-9812RR/CDA-9811R
- Cambiador de CD para CDA-9815RB/CDA-9813R/CDA-9812RB/CDA-9812RR/CDA-9811R
- Caricatore CD per CDA-9815RB/CDA-9813R/CDA-9812RB/CDA-9812RR/CDA-9811R
- CD-växlare för CDA-9815RB/CDA-9813R/CDA-9812RB/CDA-9812RR/CDA-9811R

CHA-1214

- CD changer for CDA-9815RB/CDA-9813R/CDA-9812RB/CDA-9812RR/CDA-9811R
- CD-Wechsler für CDA-9815RB/CDA-9813R/CDA-9812RB/CDA-9812RR/CDA-9811R
- Changeur CD pour CDA-9815RB/CDA-9813R/CDA-9812RB/CDA-9812RR/CDA-9811R
- Cambiador de CD para CDA-9815RB/CDA-9813R/CDA-9812RB/CDA-9812RR/CDA-9811R
- Caricatore CD per CDA-9815RB/CDA-9813R/CDA-9812RB/CDA-9812RR/CDA-9811R
- CD-växlare för CDA-9815RB/CDA-9813R/CDA-9812RB/CDA-9812RR/CDA-9811R

CHM-S630

Alpine CD Changers Give You More!

More musical selections, more versatility, more convenience.

The CHA-S634 is a high-performance 6-disc changer with a new M DAC, CD-R/RW PLAY BACK, MP3 PLAY BACK and CD TEXT. The CHA-1214 Ai-NET model holds 12 discs, and the CHM-S630 M-Bus model is a super-compact 6-disc changer with a CD-R/RW PLAY BACK.

Von Alpine CD-Wechslern haben Sie mehr!

Mehr Musikauswahl, mehr Vielseitigkeit, mehr Komfort.

Der CHA-S634 ist ein Hochleistungs-Wechsler für 6 CDs mit dem neuen M-DAC, mit CD-R/RW- und MP3-Wiedergabefunktion und mit CD-TEXT. Der CHA-1214 ist ein Ai-NET-Modell für 12 CDs. Der M-Bus-kompatible CHM-S630 ist ein superkompakter Wechsler für 6 CDs mit CD-R/RW-Wiedergabefunktion.

Changeurs de CD Alpine : vous avez le choix!

Plus de sélections musicales, plus de souplesse, plus de confort.

Le modèle CHA-S634 est un changeur 6 disques ultra performant équipé des nouvelles fonctions M DAC, CD-R/RW PLAY BACK, MP3 PLAY BACK et CD TEXT. Le modèle CHA-1214 Ai-NET contient 12 disques. Le modèle CHM-S630 M-Bus est un changeur 6 disques super compact doté de la fonction CD-R/RW PLAY BACK.

¡Los cambiadores Alpine de CD le ofrecen más!

Más selecciones musicales, más versatilidad y más ventajas.

CHA-S634 es un cambiador de seis discos de alto rendimiento con nuevo M DAC, CD-R/RW PLAY BACK, MP3 PLAY BACK y CD TEXT. El modelo CHA-1214 Ai-NET alberga 12 discos y el modelo CHM-S630 M-Bus es un cambiador de seis discos de tamaño reducido con un CD-R/RW PLAY BACK.

I caricatori CD Alpine danno di più!

Più scelta, più versatilità, più comodità.

Il modello CHA-S634 è un caricatore a 6 dischi ad elevate prestazioni dotato di un nuovo M DAC, CD-R/RW PLAY BACK, MP3 PLAY BACK e CD TEXT. Il modello CHA-1214 Ai-NET è in grado di contenere 12 dischi, il modello CHM-S630 M-Bus è un caricatore a 6 dischi ultra compatto dotato di un CD-R/RW PLAY BACK.

Alpines CD-växlare ger mer!

Fler musikval, mer variation, större bekvämlighet.

CHA-S634 är en växlare för 6 skivor med mycket höga prestanda och en ny M D/A-omvandlare samt uppspelning av CD-R/RW, MP3 och CD TEXT. CHA-1214 Ai-NET rymmer 12 skivor. CHM-S630 M-Bus är en mycket kompakt växlare med kapaciteten 6 skivor med uppspelning av CD-R/RW PLAY BACK.

Contents

The CDA-9812RX model that appears in this Manual represents the CDA-9812RB and CDA-9812RR models.

Operating Instructions



WARNING

WARNING	3
CAUTION	3
PRECAUTIONS	3

Getting Started

Turning Power On and Off	6
Initial System Start-Up	6
Opening and Closing the Movable Display	6
Display Tilt Adjustment	6
Adjusting Volume	6
Lowering Volume Quickly (CDA-9811R only)	6
Changing the Audio Level Display Pattern (CDA-9815RB/CDA-9813R/CDA-9812RX only)	7
Detaching and Attaching the Front Panel	7

Radio

Listening to Radio	8
Manual Storing of Station Presets	8
Automatic Memory of Station Presets	8
Tuning to Preset Stations	8
Station Title Search Function	9
Quick Search Function	9

RDS

Setting RDS Reception Mode and Receiving RDS Stations	9
Recalling Preset RDS Stations	10
Receiving RDS Regional (Local) Stations	10
PI SEEK Setting	10
Receiving Traffic Information	10
PTY (Programme Type) Tuning	11
Receiving Traffic Information While Playing CD or Radio	11
Priority PTY (Programme Type)	12
Displaying Radio Text	12

CD/MP3/WMA

Playback	13
Repeat Play	14
M.I.X. (Random Play)	14
Scanning Programmes	15
File/Folder Search (concerning MP3/WMA) ...	15
Quick Search	15
About MP3/WMA	15

Sound Setting

Adjusting Balance (Between Left and Right)/ Fader (Between Front and Rear)/Defeat	17
Setting the Bass Control (CDA-9812RX/CDA- 9811R only)	17
Setting the Treble Control (CDA-9812RX/CDA- 9811R only)	18
Setting the Bass Type (CDA-9812RX/CDA- 9811R only)	18
Adjusting the built-in Crossover (CDA-9812RX/CDA-9811R only)	18
Equalizer Presets (CDA-9815RB/CDA-9813R only)	18
Adjusting and Storing the Equalizer Curve (CDA-9815RB/CDA-9813R only)	19
Recalling the Stored Equalizer Curve (CDA-9815RB/CDA-9813R only)	19
About the Crossover (CDA-9815RB/CDA-9813R only)	19
Adjusting and Storing the Crossover Settings (CDA-9815RB/CDA-9813R only)	20
Recalling the Stored Crossover Settings (CDA-9815RB/CDA-9813R only)	21
About Time Correction	21
Bass Focus	22
Adjusting and Storing the Time Correction (Storing available on CDA-9815RB/CDA- 9813R only)	23
Recalling the Stored Time Correction Settings (CDA-9815RB/CDA-9813R only) ...	23
Setting the MX Mode	23

Windows Media, and the Windows logo are trademarks, or registered trademarks of Microsoft Corporation in the United States and /or other countries.

Other Functions

Displaying the Title/Text	24
Titling Discs/Stations	25
Erasing Disc Title/Station Title	25
Blackout mode On and Off	25

i-Personalize™ Operation (CDA-9815RB/CDA-9813R only)

About i-Personalize™	26
Data Downloading	26

SETUP

Sound Customizing

Adjusting Source Signal Levels	27
Switching the Tuner Mode	27
Subwoofer On and Off	27
Setting the Subwoofer Output (CDA-9815RB/ CDA-9813R only)	27
Sound (Beep) Guide Function	27

Visual Customizing

Changing Lighting Colour (CDA-9813R only)	27
Dimmer Control (CDA-9815RB/CDA-9813R/ CDA-9812RX only)	27
Scroll Setting	27
Scroll Type Setting (CDA-9815RB only)	28
Switching the Character Font (CDA-9815RB only)	28
Adjusting Display Contrast (CDA-9815RB only)	28
Demonstration	28

MP3

Playing MP3 Data	28
------------------------	----

External Device

Turning Mute Mode On/Off	28
Setting the AUX Mode (V-Link)	28
Connecting to an External Amplifier	28
Setting Tone Defeat for External Devices	28

DAB (Optional)

Using DAB Receiver for the Ensemble Seek Tuning (Optional)	29
Changing the Service	29
Changing the Service Component	29
Memorizing the Service	30
Receiving the Memorized Service	30
Memorizing the Ensemble Automatically	30
PTY (Programme Type) Tuning	30

Turning ON/OFF Traffic News Announcement	31
Setting the Announcement Select Mode	31
Changing the Display Mode	31
Displaying the Regional Label	32
Receiving Announcement Information of DAB Local Stations	32
Setting for Automatic Change from DAB to RDS	32
Setting ON/OFF for DRC (Dynamic Range Control)	32

MobileHub™ Link Operation (Optional)

About MobileHub™ Link	33
Telephone Mode ON/OFF	33
Incoming Calls	33
Calling	34
SMS (Short Message Service) Operation	34

Changer (Optional)

Controlling CD Changer (Optional)	35
Playing MP3 Files with the CD Changer (Optional)	35
Multi-Changer Selection (Optional)	35

Remote Control

Controls on Remote Control (CDA-9815RB/ CDA-9813R/CDA-9812RX only)	36
Operating the Audio Processor (CDA-9815RB/ CDA-9813R only)	36
Battery Replacement (CDA-9815RB/CDA- 9813R/CDA-9812RX only)	37

Information

In Case of Difficulty	37
Specifications	39

Installation and Connections

Warning	40
Caution	40
Precautions	40
Installation	41
Connections for CDA-9812RX/CDA-9811R ...	42
Connections for CDA-9815RB/CDA-9813R ...	44

Operating Instructions

WARNING

WARNING

This symbol means important instructions. Failure to heed them can result in serious injury or death.

DO NOT OPERATE ANY FUNCTION THAT TAKES YOUR ATTENTION AWAY FROM SAFELY DRIVING YOUR VEHICLE.

Any function that requires your prolonged attention should only be performed after coming to a complete stop. Always stop the vehicle in a safe location before performing these functions. Failure to do so may result in an accident.

KEEP THE VOLUME AT A LEVEL WHERE YOU CAN STILL HEAR OUTSIDE NOISE WHILE DRIVING.

Failure to do so may result in an accident.

DO NOT DISASSEMBLE OR ALTER.

Doing so may result in an accident, fire or electric shock.

USE ONLY IN CARS WITH A 12 VOLT NEGATIVE GROUND.

(Check with your dealer if you are not sure.) Failure to do so may result in fire, etc.

KEEP SMALL OBJECTS SUCH AS BATTERIES OUT OF THE REACH OF CHILDREN.

Swallowing them may result in serious injury. If swallowed, consult a physician immediately.

USE THE CORRECT AMPERE RATING WHEN REPLACING FUSES.

Failure to do so may result in fire or electric shock.

DO NOT BLOCK VENTS OR RADIATOR PANELS.

Doing so may cause heat to build up inside and may result in fire.

USE THIS PRODUCT FOR MOBILE 12V APPLICATIONS.

Use for other than its designed application may result in fire, electric shock or other injury.

DO NOT PLACE HANDS, FINGERS OR FOREIGN OBJECTS IN INSERTION SLOTS OR GAPS.

Doing so may result in personal injury or damage to the product.

CAUTION

This symbol means important instructions. Failure to heed them can result in injury or material property damage.

HALT USE IMMEDIATELY IF A PROBLEM APPEARS.

Failure to do so may cause personal injury or damage to the product. Return it to your authorized Alpine dealer or the nearest Alpine Service Centre for repairing.

DO NOT MIX NEW BATTERIES WITH OLD BATTERIES. INSERT WITH THE CORRECT BATTERY POLARITY.

When inserting the batteries, be sure to observe proper polarity (+ and -) as instructed. Rupture or chemical leakage from the battery may cause fire or personal injury.

KEEP FINGERS AWAY WHILE THE MOTORIZED FRONT PANEL OR MOVING MONITOR IS IN MOTION.

Failure to do so may result in personal injury or damage to the product.

PRECAUTIONS

Temperature

Be sure the temperature inside the vehicle is between +60°C (+140°F) and -10°C (+14°F) before turning your unit on.

Moisture Condensation

You may notice the CD playback sound wavering due to condensation. If this happens, remove the disc from the player and wait about an hour for the moisture to evaporate.

Damaged Disc

Do not attempt to play cracked, warped, or damaged discs. Playing a bad disc could severely damage the playback mechanism.

Maintenance

If you have problems, do not attempt to repair the unit yourself. Return it to your Alpine dealer or the nearest Alpine Service Station for servicing.

PRECAUTIONS

Never Attempt the Following

Do not grip or pull out the disc while it is being pulled back into the player by the automatic reloading mechanism.

Do not attempt to insert a disc into the unit when the unit power is off.

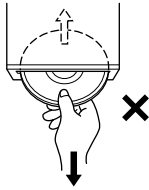

Inserting Discs

Your player accepts only one disc at a time for playback. Do not attempt to load more than one disc.

Make sure the label side is facing up when you insert the disc. Your player will automatically eject any disc that is inserted incorrectly. If the player continues to eject a correctly inserted disc, push the RESET switch with a pointed object such as a ballpoint pen.

Playing a disc while driving on a very bumpy road may result in skips, but this will not scratch the disc or damage the player.

New Discs

As a protective measure to prevent the CD from jamming, the CD player will automatically eject discs with irregular surfaces or inserted incorrectly. When a new disc is inserted into the player and ejected after initial loading, using your finger, feel around the inside of the centre hole and outside edge of the disc. If you feel any small bumps or irregularities, this could inhibit proper loading of the disc. To remove the bumps, rub the inside edge of the hole and outside edge of the disc with a ballpoint pen or other such instrument, then insert the disc again.

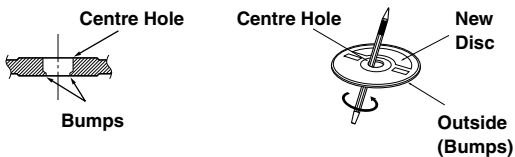

Irregular Shaped Discs

Be sure to use round shape discs only for this unit and never use any special shape discs.

Use of special shape discs may cause damage to the mechanism.



Installation Location

Make sure the CDA-9815RB/CDA-9813R/CDA-9812RX/CDA-9811R will not be installed in a location subjected to:

- Direct sun and heat
- High humidity and water
- Excessive dust
- Excessive vibrations

Correct Handling

Do not drop the disc while handling. Hold the disc so you will not leave fingerprints on the surface. Do not affix tape, paper, or gummed labels to the disc. Do not write on the disc.

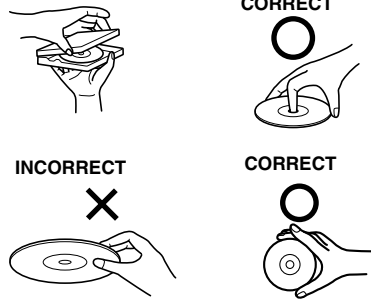

Disc Cleaning

Fingerprints, dust, or soil on the surface of the disc could cause the CD player to skip. For routine cleaning, wipe the playing surface with a clean, soft cloth from the centre of the disc to the outer edge. If the surface is heavily soiled, dampen a clean, soft cloth in a solution of mild neutral detergent before cleaning the disc.



Disc Accessories

There are various accessories available on the market for protecting the disc surface and improving sound quality. However, most of them will influence the thickness and/or diameter of the disc. Using such accessories can cause the disc to be out of standard specifications and may create operational problems. We recommend not using these accessories on discs played in Alpine CD players.

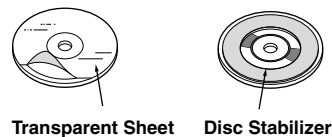

On handling Compact Discs (CD/CD-R/CD-RW)

- Do not touch the surface.
- Do not expose the disc to direct sunlight.
- Do not affix stickers or labels and do not write on the surface.
- Clean the disc when it is dusty.
- Make sure that there are no bumps around the disc.
- Do not use commercially available disc accessories.

Do not leave the disc in the car or the unit for a long time. Never expose the disc to direct sunlight. Heat and humidity may damage the CD and you may not be able to play it again.

To customers using CD-R/CD-RW

- If a CD-R/CD-RW cannot be played back, make sure the last recording session was closed (finalized).
- Finalize the CD-R/CD-RW if necessary, and attempt playback again.

About discs that can be used with the CDA-9815RB/CDA-9813R/CDA-9812RX models.

Use only compact discs with the label side showing the CD logo marks below.



If you use unspecified compact discs, correct performance cannot be guaranteed.

You can play CD-Rs (CD-Recordable)/CD-RWs (CD-ReWritable) for audio use on this unit. You can also play CD-Rs/CD-RWs containing MP3/WMA formatted audio files.

- Some of the following CDs may not play on this unit:
Flawed CDs, CDs with fingerprints, CDs exposed to extreme temperatures or sunlight (e.g., left in the car or this unit), CDs recorded under unstable conditions, CDs on which a recording failed or a re-recording was attempted, copy-protected CDs which do not conform to the audio CD industry standard.
- Use discs with MP3/WMA files written in a format compatible with this unit. For details, see page 15-16.

About discs that can be used with the CDA-9811R model.

We recommend using only compact discs containing the marks shown below.

You can play CD-Rs (CD-Recordable)/CD-RWs (CD-ReWritable) for audio use on this unit. You can not play CD-Rs/CD-RWs containing MP3/WMA formatted audio files.

- Some of the following CDs may not play on this unit:
Flawed CDs, CDs with fingerprints, CDs exposed to extreme temperatures or sunlight (e.g., left in the car or this unit), CDs recorded under unstable conditions, CDs not designed for audio use, CDs on which a recording failed or a re-recording was attempted.



Getting Started

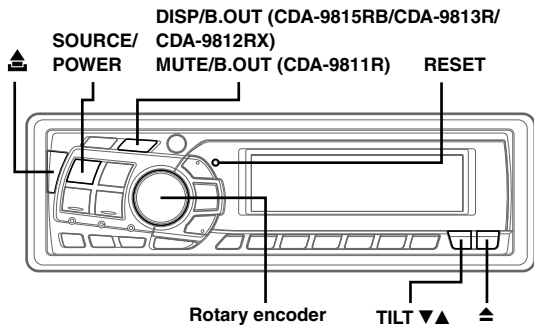

Turning Power On and Off

Press **SOURCE/POWER** to turn on the unit.

- The unit can be turned on by pressing any other button except eject ▲.

The volume level gradually increases to the previous level you were listening to before the unit was turned off.

Press and hold **SOURCE/POWER** for at least 3 seconds to turn off the unit.

- The first time power is turned on, the volume will start from level 12.

Initial System Start-Up

Be sure to press the RESET switch when using the unit for the first time, after installing the CD changer, after changing the car battery, etc.

- Turn off the unit power.
- Press **RESET** with a ball-point pen or similar pointed object.

Opening and Closing the Movable Display

Press ▲.

The movable display will open.

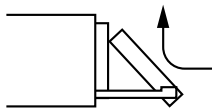

To close the movable display, press ▲ again.

The movable display will close.

- Do not apply shock to the movable display when it is open as it may result in malfunction of the unit.
- The display may be dim during low temperatures and immediately after turning on the power. The brightness will return to normal as time elapses.
- The display will stop at the set tilt angle when closing.

Caution

Keep hands (or any other object) away from the display while it is opening or closing to avoid damage or injury. The back of the movable display will get very warm under normal operating conditions. This is not a malfunction. Do not touch.

Display Tilt Adjustment

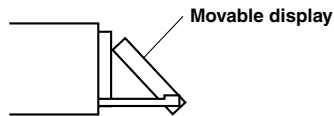

The movable display may be adjusted to 3 different tilt angles depending upon user preference.

Press **TILT ▼▲** to adjust the tilt angle of the movable display.

- The display will close a half minute after the ignition key is turned to the OFF position.
- The adjusted tilt angle of the display is stored in memory. There is no need to re-adjust the tilt angle when the power is turned back on.

Caution

Keep hands (or any other object) away from the display while it is opening or closing to avoid damage or injury. The back of the movable display will get very warm under normal operating conditions. This is not a malfunction. Do not touch.

Adjusting Volume

Turn the **Rotary encoder** until the desired sound is obtained.

Lowering Volume Quickly (CDA-9811R only)

Activating the Audio Mute function will instantly lower the volume level by 20 dB.

Press **MUTE/B.OUT** to activate the MUTE mode.

The audio level will decrease by about 20 dB.

Pressing **MUTE/B.OUT** again will bring the audio back to its previous level.

Changing the Audio Level Display Pattern (CDA-9815RB/CDA-9813R/CDA-9812RX only)

You can select the Audio Level display from three display patterns.
You can also deactivate the display.

Press **DISP/B.OUT** to switch the display pattern.

For CDA-9815RB/CDA-9813R:

AUDIO ADJUSTMENT → EQ ADJUSTMENT → X-OVER
ADJUSTMENT → OFF → AUDIO ADJUSTMENT

For CDA-9812RX:

AUDIO ADJUSTMENT → BASS ADJUSTMENT → TREBLE
ADJUSTMENT → OFF → AUDIO ADJUSTMENT

The indicators show the value that is set in each mode as shown below.

	AUDIO ADJUSTMENT	EQ/BASS/TREBLE ADJUSTMENT	X-OVER ADJUSTMENT
Level Indicator	VOLUME	LEVEL	LEVEL
Width indicator	BALANCE	WIDTH	SLOPE
Frequency Indicator	FADER	FREQUENCY	FREQUENCY
Sub-W Indicator	SUB-W*	-	-

*Only when SUB-W is set to ON

AUDIO Adjustment Display Example for CDA-9813R

VOLUME : 18
BALANCE : L6
FADER : F6
SUB-W : 9dB

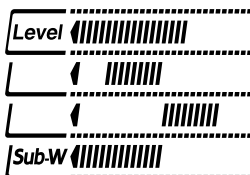

EQ Adjustment Display Example for CDA-9813R

LEVEL : +2
WIDTH : 2
FREQUENCY: 200Hz



X-OVER Adjustment Display Example for CDA-9813R

LEVEL : -7dB
SLOPE : 2 (-12dB/oct)
FREQUENCY : 2k



Detaching and Attaching the Front Panel

Detaching

- 1 Turn off the unit power.
- 2 Press **▲** (Release) at the upper left side until the front panel pops out.
- 3 Grasp the left side of the front panel and pull it out.

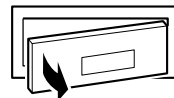

- The front panel may become hot in normal usage (especially the connector terminals on the back of the front panel.) This is not a malfunction.
- To protect the front panel, place it in the supplied carrying case.

Attaching

- 1 Insert the right side of the front panel into the main unit. Align the groove on the front panel with the projections on the main unit.
- 2 Push the left side of the front panel until it locks firmly into the main unit.

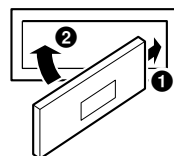

- Before attaching the front panel, make sure that there is no dirt or dust on the connector terminals and no foreign object between the front panel and the main unit.
- Attach the front panel carefully, holding the sides of the front panel to avoid pushing buttons by mistake.

Radio

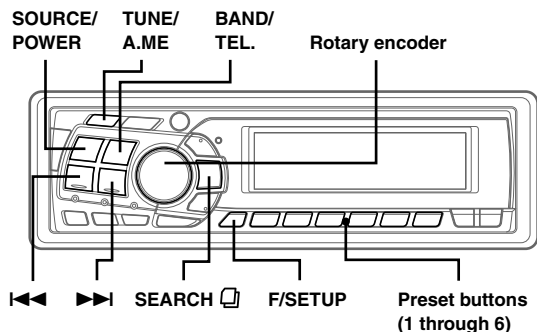

Listening to Radio

1 Press **SOURCE/POWER** until a radio frequency appears in the display.

2 Press **BAND/TEL.** repeatedly until the desired radio band is displayed.

FM1 (F1) → FM2 (F2) → FM3 (F3) → MW → LW → FM1 (F1)

3 Press **TUNE/A.ME** to select the tuning mode.

CDA-9815RB:

DX SEEK (Distance mode) → SEEK (Local mode) → OFF (Manual mode) → DX SEEK

CDA-9813R/CDA-9812RX:

DX SEEK (Distance mode) → DX SEEK (Local mode) → DX SEEK (Manual mode) → DX SEEK

CDA-9811R:

DX SEEK (Distance mode) → DX SEEK (Local mode) → DX SEEK (Manual mode) → DX SEEK

• The initial mode is Distance mode.

Distance mode:

Both strong and weak stations will be automatically tuned in (Automatic Seek Tuning).

Local mode:

Only strong stations will be automatically tuned in (Automatic Seek Tuning).

Manual mode:

The frequency is manually tuned in steps (Manual tuning).

4 Press **◀◀** or **▶▶** to tune in the desired station. Holding down **◀◀** or **▶▶** will change the frequency continuously.

• The *ST* indicator appears on the display when a stereo FM station is tuned in.

Manual Storing of Station Presets

1 Select the radio band and tune in a desired radio station you wish to store in the preset memory.

2 Press and hold any one of the **preset buttons (1 through 6)** that you want to store the station on for at least **2 seconds**.

The selected station is stored.

The display shows the band, preset no. and station frequency memorized.

- A total of 30 stations can be stored in the preset memory (6 stations for each band; FM1, FM2, FM3, MW and LW).
- If you store a station in a preset memory which already has a station, the current station will be cleared and replaced with the new station.
- If the "FUNC" indicator (only the underlined portion of the "FUNC" indicator for CDA-9811R) is illuminated, turn off the indicator by pressing **F/SETUP**, then you can perform the operation.

Automatic Memory of Station Presets

1 Press **BAND/TEL.** repeatedly until the desired radio band is displayed.

2 Press and hold **TUNE/A.ME** for at least **2 seconds**.

The frequency on the display continues to change while the automatic memory is in progress. The tuner will automatically seek and store 6 strong stations in the selected band. They will be stored into buttons 1 to 6 in order of signal strength.

When the automatic memory has been completed, the tuner goes to the station stored in preset location no. 1.

- If no stations are stored, the tuner will return to the original station you were listening to before the auto memory procedure began.

Tuning to Preset Stations

1 Press **BAND/TEL.** repeatedly until the desired band is displayed.



2 Press any one of the **station preset buttons (1 through 6)** that has your desired radio station in memory.

The display shows the band, preset number and frequency of the station selected.

- If the "FUNC" indicator (only the underlined portion of the "FUNC" indicator for CDA-9811R) is illuminated, turn off the indicator by pressing **F/SETUP**, then you can perform the operation.



Station Title Search Function

If titles for radio stations are entered, you can search for a radio station from its title.

- 1 Press **SEARCH**  in Radio mode to switch to Title Search mode.
The first title input blinks in the display.
 - 2 Select the desired title by turning the **Rotary encoder** within 10 seconds.
 - 3 Press the **Rotary encoder** to receive the frequency of the selected title.
- Search mode in Title Search mode is canceled by pressing and holding **SEARCH**  for at least 2 seconds.
 - If a station has no title, "NO TITLE" is displayed for 2 seconds.

Quick Search Function

You can search for a radio station by its frequency.

- 1 Press and hold **SEARCH**  for at least 2 seconds in Radio mode to activate Quick Search mode.
 - 2 Turn the **Rotary encoder** within 10 seconds to select the desired frequency.
 - 3 Press the **Rotary encoder** to receive the selected frequency.
- Search mode in Quick Search mode is canceled by pressing and holding **SEARCH**  for at least 2 seconds.

RDS

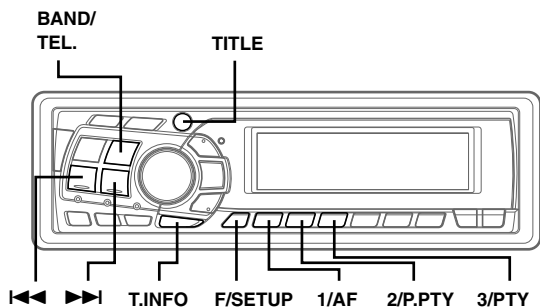

Setting RDS Reception Mode and Receiving RDS Stations

The RDS (Radio Data System) is a radio information system using the 57 kHz subcarrier of regular FM broadcast. The RDS allows you to receive a variety of information such as traffic information, station names, and to automatically re-tune to a stronger transmitter that is broadcasting the same programme.

- 1 Press **F/SETUP** so that the "FUNC" indicator (only the underlined portion of the "FUNC" indicator for CDA-9811R) lights up.
 - 2 Press **1/AF** to activate the RDS mode.
 - 3 Press **◀◀** or **▶▶** to tune in the desired RDS station.
 - 4 Press **1/AF** again to deactivate the RDS mode.
 - 5 Press **F/SETUP** to activate the normal mode. The "FUNC" indicator (only the underlined portion of the "FUNC" indicator for CDA-9811R) goes out.
- When the unit receives the **PTY31** (Emergency Broadcast) signal, the unit will show "ALARM" in the display automatically.

The RDS digital data includes the following:

PI	Programme Identification
PS	Programme Service Name
AF	List of Alternative Frequencies
TP	Traffic Programme
TA	Traffic Announcement
PTY	Programme Type
EON	Enhanced Other Networks

Recalling Preset RDS Stations

- 1 Press **F/SETUP** so that the “FUNC” indicator (only the underlined portion of the “FUNC” indicator for CDA-9811R) lights up.
- 2 Press **1/AF** to activate the RDS mode.
- 3 Press **F/SETUP** to activate the normal mode. The “FUNC” indicator (only the underlined portion of the “FUNC” indicator for CDA-9811R) goes out.
- 4 Make sure that the “FUNC” indicator (only the underlined portion of the “FUNC” indicator for CDA-9811R) light goes out, then press the preset button in which your desired RDS station is preset. If the preset station’s signal is weak, the unit automatically searches and tunes to a stronger station in the AF (Alternative Frequencies) list.
- 5 If the preset station and the stations in the AF list cannot be received:
When the PI SEEK setting is on (refer to “PI SEEK Setting” on this page), the unit searches again for a station in the PI (Programme Identification) list.
If there are still no stations receivable in the area, the unit displays the frequency of the preset station and the preset no. disappears.
If the signal level of the Regional (Local) station being tuned becomes too weak to receive, press the same preset button to tune in a Regional station in other district.

- For presetting the RDS stations, refer to the Radio Operation section. The RDS stations can be preset in the FM1, FM2 and FM3 bands only.

Receiving RDS Regional (Local) Stations

- 1 Press and hold **F/SETUP** for at least 3 seconds to activate the setting mode.
- 2 Press **◀▶** or **▶▶** to select the RDS REG (Regional) mode.
- 3 Press **BAND/TEL.** to turn on or off the RDS REG (Regional) mode.
In the RDS REG OFF mode, the unit automatically keeps receiving the related local RDS station.
- 4 Press **F/SETUP** to deactivate the setting mode.

PI SEEK Setting

- 1 Press and hold **F/SETUP** for at least 3 seconds.
- 2 Press **◀▶** or **▶▶** to select “PI SEEK”(CDA-9811R:“PISK”).
- 3 Press **BAND/TEL.** to toggle the mode between “PI SEEK ON” (CDA-9811R:“PISK ON”) and “PI SEEK OFF” (CDA-9811R:“PISK OFF”).
- 4 Press **F/SETUP** to set the selected mode.

Receiving Traffic Information

- 1 Press **T.INFO** so that the underlined portion of the “T.INFO” indicator lights up. (Only the upper lined portion of the “T.INFO” indicator for CDA-9813R/CDA-9812RX.)
- 2 Press **◀▶** or **▶▶** to select your desired traffic information station.

When a traffic information station is tuned in, the underlined portion of the “TP” indicator (only the upper lined portion of the “TP” indicator for CDA-9813R/CDA-9812RX) lights up. Traffic information is heard only when it is being broadcast. If traffic information is not being broadcast, the unit is set in the standby mode. When a traffic information broadcast begins, the unit automatically receives it and the display shows “TRF-INFO” for a few seconds and returns to the PS display. When the traffic information broadcast is over, the unit will automatically set in the standby mode.

- If the traffic information broadcast signal falls below a certain level, the unit remains in the receiving mode for 1 minute. If the signal remains below a certain level for over 1 minute, the underlined portion of the “T.INFO” indicator blinks. (Only the upper lined portion of the “T.INFO” indicator for CDA-9813R/CDA-9812RX.)
- If you do not want to listen to the traffic information being received, lightly press T.INFO to skip that traffic information message. The T.INFO mode will remain in the ON position to receive the next traffic information message.
- If the volume level is changed while receiving traffic information, the changed volume level will be memorized. When traffic information is received next time, the volume level will be automatically adjusted to the level memorized.
- In the T.INFO mode, the SEEK tuning selects only the TP stations.

PTY (Programme Type) Tuning

1 Press **F/SETUP** so that the "**FUNC**" indicator lights up. (Only the underlined portion of the "**FUNC**" indicator for CDA-9811R.)

2 Press **3/PTY** to activate the PTY mode, while the unit is in Radio (FM receiving) mode.

The Programme Type of the station being currently received will be displayed for 5 seconds.

If there is no receivable PTY broadcast, "NO PTY" will be displayed for 5 seconds.

If no RDS station can be received, the display shows "NO PTY."

- If no operation is performed within 5 seconds after pressing **PTY**, the **PTY** mode will be automatically cancelled.

3 Press **◀▶** within 5 seconds after activating the **PTY** mode to choose the desired programme type while the **PTY (programme type)** is being displayed.

Each press scrolls the programme type by one.

--- LIGHT M ↔ CLASSICS ↔ OTHER M ---
 - - - - -

4 Press **3/PTY** within 5 seconds after selecting the programme type to start searching for a station in the selected programme type.

The chosen programme type display blinks during searching and lights when a station is found.

If no PTY station is found, "NO PTY" will be displayed for 5 seconds.

5 Press **F/SETUP** to activate the normal mode. The "**FUNC**" indicator (only the underlined portion of the "**FUNC**" indicator for CDA-9811R) goes out.

- Operate the unit while the "**FUNC**" indicator (only the underlined portion of the "**FUNC**" indicator for CDA-9811R) lights up. If no operation is performed within 5 seconds, the "**FUNC**" indicator (only the underlined portion of the "**FUNC**" indicator for CDA-9811R) goes out.

Receiving Traffic Information While Playing CD or Radio

1 Press **T.INFO** so that the underlined portion of the "**T.INFO**" indicator lights up. (Only the upper lined portion of the "**T.INFO**" indicator for CDA-9813R/CDA-9812RX.)

2 Press **◀▶** and **▶▶** to select a traffic information station if necessary.

When a traffic information broadcast starts, the unit automatically mutes the CD player/changer or the regular FM broadcast.

When the traffic information broadcast finishes, the unit automatically returns to the original source play before the traffic information broadcast began.

When traffic information stations cannot be received:

In the tuner mode:

When the TP signal can no longer be received for over 1 minute, the underlined portion of the "**T.INFO**" indicator (only the upper lined portion of the "**T.INFO**" indicator for CDA-9813R/CDA-9812RX) blinks.

In the CD mode:

When the TP signal can no longer be received, the traffic information station of another frequency will be selected automatically.

- The receiver is equipped with the *EON (Enhanced Other Networks)* function in order to keep track of additional alternate frequencies to the AF list. The underlined portion of the "**EON**" indicator (only the upper lined portion of the "**EON**" indicator for CDA-9813R/CDA-9812RX) lights up while an RDS EON station is being received. If the station being received does not broadcast the traffic information, the receiver automatically tunes in the related station that broadcasts the traffic information when it occurs.

3 Press **T.INFO** to deactivate the Traffic Information mode.

The underlined portion of the "**T.INFO**" indicator (only the upper lined portion of the "**T.INFO**" indicator for CDA-9813R/CDA-9812RX) goes out.

Priority PTY (Programme Type)

This function allows presetting of a programme type such as music category, news, etc. You can listen to a programme in the preset programme type as the unit automatically gives priority to the preset programme type when it begins broadcasting, and interrupts the programme you are currently listening. This feature is functional when your unit is set to a mode other than the LW and MW.

1 Press F/SETUP so that the “FUNC” indicator (only the underlined portion of the “FUNC” indicator for CDA-9811R) lights up.

2 Press 2/P.PTY to activate the PRIORITY PTY mode.

“PRIO-PTY” is displayed for 2 seconds and then the programme type for 3 seconds. The initial setting is “NEWS.”

- If no operation is performed within 5 seconds after pressing 2/P.PTY, the PRIORITY PTY mode is automatically cancelled.

3 Press ◀◀ or ▶▶ within 5 seconds while “NEWS” is being displayed to choose a desired programme type. Then press 2/P.PTY.

The PRIORITY PTY function will activate.

4 Press 2/P.PTY to activate the PRIORITY PTY mode again.

To change the programme category, perform the step 3. To disable the PRIORITY PTY function, press and hold 2/P.PTY for at least 2 seconds.

- In the PRIORITY PTY function, unlike in the T.INFO function, the volume does not increase during operation.

5 Press F/SETUP to activate the normal mode. The “FUNC” indicator (only the underlined portion of the “FUNC” indicator for CDA-9811R) goes out.

- Operate the unit while the “FUNC” indicator (only the underlined portion of the “FUNC” indicator for CDA-9811R) lights up. If no buttons are pressed within 5 seconds, the “FUNC” indicator (only the underlined portion of the “FUNC” indicator for CDA-9811R) goes out.

Displaying Radio Text

Text messages from a radio station can be displayed.

1 Press TITLE while receiving FM in the radio mode to select the Radio Text display.

The display will change every time the button is pressed.

CDA-9815RB

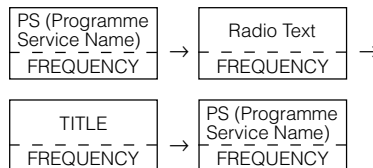

CDA-9813R/CDA-9812RX/CDA-9811R

PS (Programme Service Name) → Radio Text → STATION
TITLE → FREQUENCY → PS (Programme Service Name)

The display shows “WAITING” for a few seconds, then starts scrolling the text message.

- If there is no receivable text message or the unit cannot receive a text message properly, the display shows “NO TEXT.”

CD/MP3/WMA

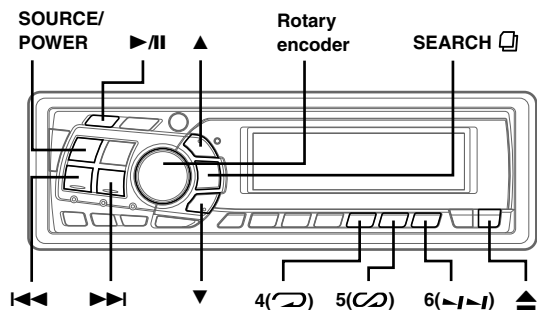

To customers who use CDA-9815RB/CDA-9813R/CDA-9812RX:

MP3/WMA can be played back on the built-in CD Player of this unit.

To customers who use CDA-9811R:

MP3 can be played back if an MP3 compatible CD changer is connected. However, WMA cannot be played back.

Playback

1 Press ▲.

The movable display will open.

2 Insert a disc with the label side facing up.

The disc will be pulled into the unit automatically.

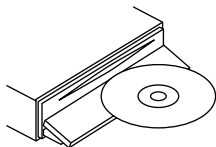

The movable display will close and playback will begin.

When a disc is already inserted, press SOURCE/POWER to switch to the CD mode.

The mode will change every time the button is pressed.

TUNER → CD → CD CHANGER* → TUNER

* Only when the CD changer is connected

3 Press ◀◀ or ▶▶ to select the desired track (file).

Returning to the beginning of the current track (file):

Press ◀◀.

Fast backward :

Press and hold ◀◀.

Advancing to the beginning of the next track (file) :

Press ▶▶.

Fast forward :

Press and hold ▶▶.

4 To pause playback, press ▶/||.

Pressing ▶/|| again will resume playback.

5 To eject the disc, press ▲.

- Do not remove a CD during its eject cycle. Do not load more than one disc at a time. A malfunction may result from doing either.
- If the CD does not eject, press and hold ▲ for at least 3 seconds with the movable display open.
- The CD-player can play discs containing audio data, MP3 data and WMA data.
- The MP3 indicator is lit during MP3 playback.
- The WMA indicator is lit during WMA playback.
- The track display for MP3/WMA data playback is the file numbers recorded on the disc.
- While playing back MP3/WMA, press ▲ or ▼ to move the folder up or down.

Repeat Play

Press **4**() to play back repeatedly the track being played.

The track (file) will be played repeatedly.

Press **4**() again and select OFF to deactivate repeat play.

CD mode :

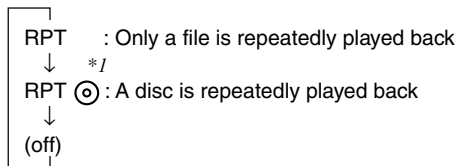

*1 When a CD changer is connected

- If REPEAT is set to ON during M.I.X. play in CD changer mode, M.I.X. will apply to the current disc only.

MP3/WMA mode :

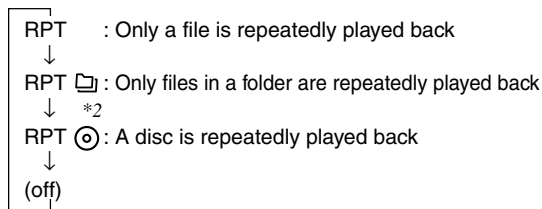

*2 When an MP3 compatible CD changer is connected

- If a 6-disc CD changer or an MP3 compatible CD changer is connected:
In CD changer mode, press **F/SETUP** to illuminate the "FUNC" indicator (only underlined portions of the "FUNC" indicator are illuminated for CDA-9811R), and go to the step above within 5 seconds.
- If a 12-disc CD changer is connected:
In CD changer mode, press **F/SETUP** twice to illuminate the "FUNC" indicator (only underlined portions of the "FUNC" indicator are illuminated for CDA-9811R), and go to the step above within 5 seconds.

M.I.X. (Random Play)

Press **5**() in the play or pause mode.

The tracks (files) on the disc will be played back in random sequence.

To cancel M.I.X. play, press **5**() again.

CD mode :

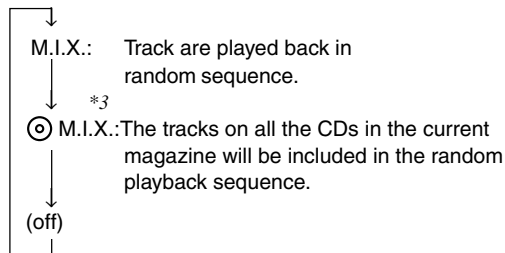

*3 When a CD changer equipped with the All M.I.X. function is connected

- If M.I.X. is set to ON during RPT  (REPEAT ALL) play in CD changer mode, M.I.X. will apply to the current disc only.

MP3/WMA mode :

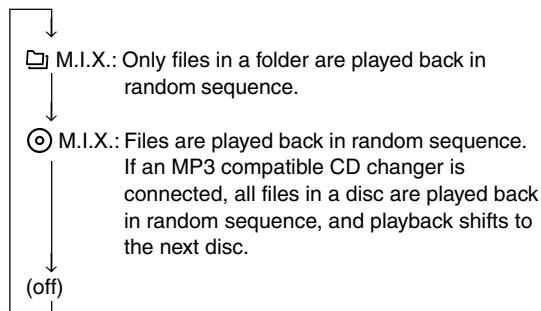

- If a 6-disc CD changer or an MP3 compatible CD changer is connected:
In CD changer mode, press **F/SETUP** to illuminate the "FUNC" indicator (only underlined portions of the "FUNC" indicator are illuminated for CDA-9811R), and go to the step above within 5 seconds.
- If a 12-disc CD changer is connected:
In CD changer mode, press **F/SETUP** twice to illuminate the "FUNC" indicator (only underlined portions of the "FUNC" indicator are illuminated for CDA-9811R), and go to the step above within 5 seconds.
- A disc that contains more than 40 tracks may not be correctly played back with the M.I.X. function on the CDA-9811R.

Scanning Programmes

Press 6(↵) to activate the Scan mode.

The first 10 seconds of each track (file) will be played back in succession.

To stop scanning, press 6(↵) and deactivate the Scan mode.



- If a 6-disc CD changer or an MP3 compatible CD changer is connected:
In CD changer mode, press **F/SETUP** to illuminate the "FUNC" indicator (only underlined portions of the "FUNC" indicator are illuminated for CDA-9811R), and go to the step above within 5 seconds.
- If a 12-disc CD changer is connected:
In CD changer mode, press **F/SETUP** twice to illuminate the "FUNC" indicator (only underlined portions of the "FUNC" indicator are illuminated for CDA-9811R), and go to the step above within 5 seconds.

File/Folder Search (concerning MP3/WMA)



- 1 Press **SEARCH**  to select File Search mode or Folder Search mode in MP3/WMA mode.

File Search mode

- 2 Press **▲** or **▼** to select another Folder.
- 3 Select the desired file by turning the **Rotary encoder** within 10 seconds.
- 4 Press the **Rotary encoder** to play back the selected file.



- File Search mode is cancelled by pressing and holding **SEARCH**  for at least 2 seconds.
- While in File Search mode, press **SEARCH**  to switch to Folder Search mode.

Folder Search mode

- 2 Turn the **Rotary encoder** within 10 seconds to select the desired folder.
 - 3 Press the **Rotary encoder** to play back the first file in the selected folder.
- Search mode is cancelled by pressing and holding **SEARCH**  for at least 2 seconds in Folder Search mode.
 - While in Folder Search mode, press **SEARCH**  to switch to File Search mode.
 - "NO FILE" is displayed for 2 seconds if the folder that is selected by the Folder Search mode contains no files.
 - "-----" is displayed for the root folder (display example: CDA-9811R).

Quick Search

You can search for tracks (files).

- 1 Press and hold **SEARCH**  for at least 2 seconds in the CD/Changer/MP3/WMA mode to activate Quick Search mode.
 - 2 Turn the **Rotary encoder** within 10 seconds to select a desired track (file).
The selected track is played back immediately.
- Search mode is cancelled by pressing and holding **SEARCH**  for at least 2 seconds in Quick Search mode.

About MP3/WMA

CAUTION

Except for private use, duplicating audio data (including MP3/WMA data) or distributing, transferring, or copying it, whether for free or for a fee, without permission of the copyright holder is strictly prohibited by the Copyright Act and by international treaty.

What is MP3?

MP3, whose official name is "MPEG Audio Layer 3," is a compression standard prescribed by the ISO, the International Standardization Organization and MPEG which is a joint activity institution of the IEC.

MP3 files contain compressed audio data. MP3 encoding is capable of compressing audio data at extremely high ratios, reducing the size of music files to as much as one-tenth their original size. This is achieved while still maintaining near CD quality. The MP3 format realizes such high compression ratios by eliminating the sounds that are either inaudible to the human ear or masked by other sounds.

What is WMA?

WMA, or "Windows Media™ Audio," is compressed audio data.

WMA allows you to create music files and store them at higher ratios of compression than MP3 audio data (approx. half original size). This is achieved while still maintaining CD quality sound.

Method for creating MP3/WMA files

Audio data is compressed by using MP3/WMA specified software. For details on creating MP3/WMA files, refer to the user's manual for that software.

MP3/WMA files that can be played back by this device have the file extension "mp3" / "wma". Files with no extension cannot be played back. (WMA ver. 7.1 and 8 are supported)

Supported playback sampling rates and bit rates

MP3
Sampling rates: 48 kHz, 44.1 kHz, 32 kHz, 24 kHz, 22.05 kHz, 16 kHz, 12 kHz, 11.025 kHz, 8 kHz
Bit rates: 8 - 320 kbps

WMA
Sampling rates: 48 kHz, 44.1 kHz, 32 kHz, 24 kHz, 22.05 kHz
Bit rates: 32 - 192 kbps
Note that for sampling rates, this device's frame display (Page 24) may not display correctly.
This device may not play back correctly depending on sampling rates.

ID3 tags/WMA tags

This device supports ID3 tag v1 and v2, and WMA tag. If tag data is in an MP3/WMA file, this device can display the title (track title), artist name, and album name ID3 tag/WMA tag data.

This device can only display single-byte alphanumeric characters (up to 30) and the underscore. For non-supported characters, "NO SUPPORT" ("NO SUPRT" for CDA-9811R) is displayed.

Producing MP3/WMA discs

MP3/WMA files are prepared, then written to a CD-R or CD-RW using CD-R writing software. A disc can hold up to 510 files/folders (including Root Folders).

Media supported

The media that this device can play back are CD-ROMs, CD-Rs, and CD-RWs.

Corresponding File Systems

This device supports discs formatted with ISO9660 Level 1 or Level 2.

Under the ISO9660 standard, there are some restrictions to remember.

The maximum nested folder depth is 8 (including the root directory). File/folder names are limited to 31 characters (including the extension), and are limited to 15 characters for WMA.

Valid characters for folder/file names are letters A-Z (all caps), numbers 0-9, and '_' (underscore).

This device also can play back discs in Joliet, Romeo, etc., and other standards that conform to ISO9660. However, sometimes the file names, folder names, etc., are not displayed correctly.

Formats supported

This device supports CD-ROM XA, Mixed Mode CD, Enhanced CD (CD-Extra) and Multi-Session.

This device cannot correctly play back discs recorded with Track At Once or packet writing.

Order of tracks

The unit plays the files in the order that the writing software writes them. Therefore, the playing order may not be the same as the order you input. The playback order of the folders and files is as follows. However, the folder and file playback order differs from the folder no. and file no. indicated on the display.

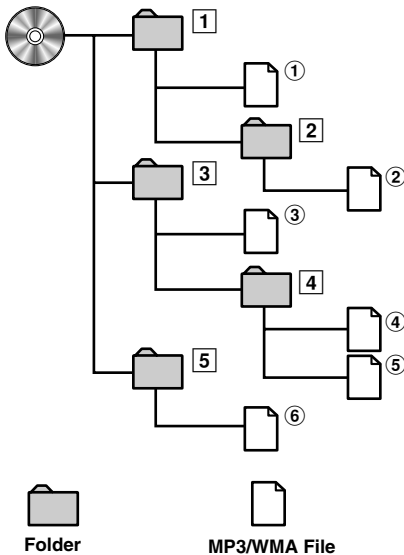

Terminology

Bit rate

This is the "sound" compression rate specified for encoding. The higher the bit rate, the higher the sound quality, but also the larger the files.

Sampling rate

This value shows how many times per second the data is sampled (recorded). For example, music CDs use a sampling rate of 44.1 kHz, so the sound is sampled (recorded) 44,100 times per second. The higher the sampling rate, the higher the sound quality, but also the larger the volume of data.

Encoding

Converting music CDs, WAVE (AIFF) files, and other sound files into the specified audio compression format.

Tag

Song information such as track titles, artist names, album names, etc., written into MP3/WMA files.

MP3: ID3 tag

WMA: WMA tag

Sound Setting

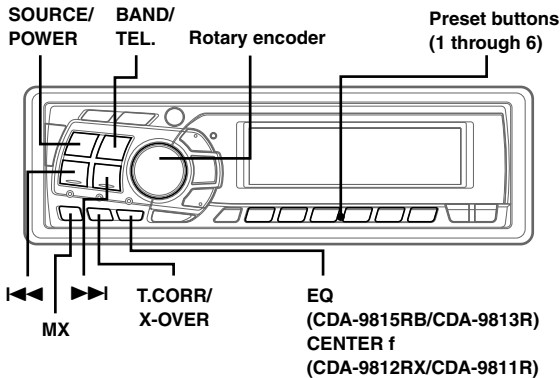

Adjusting Balance (Between Left and Right)/ Fader (Between Front and Rear)/Deafat

1 Press Rotary encoder repeatedly to choose the desired mode.

Each press changes the modes as follows:

SUBWOOFER*1 → BALANCE → FADER → DEFEAT → VOLUME → SUBWOOFER*1

Subwoofer : 0 ~ +15
 Balance : L15 ~ R15
 Fader : R15 ~ F15
 Defeat : ON/OFF
 Volume : 0 ~ 35

Press **◀◀** or **▶▶** after selecting the Subwoofer mode, and the subwoofer output phase is toggled NORMAL (PHASE 0°) or REVERS (PHASE 180°).

- If the Rotary encoder is not pressed within 5 seconds after selecting the BALANCE, FADER, DEFEAT or SUBWOOFER mode, the unit automatically returns to normal mode.
- When setting the 2WAY/3WAY switch (page 44) to 3WAY, you cannot adjust the FADER mode on the CDA-9815RB/CDA-9813R.

*1 When the subwoofer mode is set to OFF, its level and phase cannot be adjusted.

2 Turn the Rotary encoder until the desired sound is obtained in each mode.

By setting Defeat ON, previously adjusted settings of BASS, TREBLE and EQ will return to the factory defaults and MX is turned off.

- Depending on the connected devices, some functions and display indications do not work.
- When you press **DISP/B.OUT**, you can switch the Level Indicator display to the AUDIO Adjustment display only on the CDA-9815RB/CDA-9813R/CDA-9812RX. For details, see "Changing the Audio Level Display Pattern" (page 7).

Setting the Bass Control (CDA-9812RX/CDA-9811R only)

You can change the bass frequency emphasis to create your own tonal preference.

1 Press CENTER f to select the Bass (bass centre frequency) Control mode.

BASS → TREBLE → normal mode → BASS

2-1*2 Setting the bass centre frequency: Press **◀◀** or **▶▶** to select the desired bass centre frequency.

60Hz ↔ 70Hz ↔ 80Hz ↔ 90Hz ↔ 100Hz ↔ 130Hz ↔ 150Hz ↔ 200Hz ↔ 60Hz

The displayed bass frequency is emphasized

2-2*2 Setting the bass band width (Q-Factor): Press **BAND/TEL.** to select the desired bass band width.

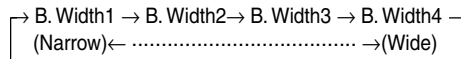

Changes the boosted bass band width to wide or narrow. A wide setting will boost a wide range of frequencies above and below the centre frequency. A narrower setting will boost only frequencies near the centre frequency.

2-3 Setting the bass level: Turn the Rotary encoder to select the desired bass level (-7~+7).

You can emphasize or weaken the bass frequency.

- If no operation is performed within 15 seconds, the bass control setting will be turned off automatically.
- The bass level settings will be individually memorized for each source (FM, MW (LW), CD, etc.) until the setting is changed. The bass frequency and bass band width settings adjusted for one source are effective for all other sources (FM, MW (LW), CD etc.).
- Depending on the connected devices, some functions and display indications do not work. However, bass level is still adjustable if an audio processor with the bass adjustment is connected.
- This function is inoperable when DEFEAT is set to ON.
- *2 Selecting any of the "Setting the Bass Type" (TYPE 1 through 3), temporarily replaces the custom settings you have made above.
- When you press **DISP/B.OUT** on the CDA-9812RX, you can switch the level Indicator display to the BASS adjustment display. For details, see "Changing the Audio Level Display Pattern" (page 7).

Setting the Treble Control (CDA-9812RX/CDA-9811R only)

You can change the Treble Frequency emphasis to create your own tonal preference.

1 Press **CENTER f** to select the Treble (treble centre frequency) Control mode.

BASS → TREBLE → normal mode → BASS

2-1 Setting the treble Centre frequency:

Press **◀◀** or **▶▶** to select the desired treble centre frequency.

10.0kHz ↔ 12.5kHz ↔ 15.0kHz ↔ 17.5kHz ↔ 10.0kHz
The displayed Treble frequency is emphasized.

2-2 Setting the treble level:

Turn the **Rotary encoder** to select the desired treble level (-7~+7).

You can emphasize the treble frequency.

- If no operation is performed within 15 seconds, the treble control setting will be turned off automatically.
- The treble level settings will be individually memorized for each source (FM, MW (LW), CD, etc.) until the setting is changed. The Treble frequency settings adjusted for one source are effective for all other sources (FM, MW (LW), CD, etc.).
- Depending on the connected devices, some functions and display indications do not work. However, treble level is still adjustable if an audio processor with the treble adjustment is connected.
- This function is inoperable when DEFEAT is set to ON.
- When you press **DISP/B.OUT** on the CDA-9812RX, you can switch the level Indicator display to the TREBLE adjustment display. For details, see "Changing the Audio Level Display Pattern" (page 7).

Setting the Bass Type (CDA-9812RX/CDA-9811R only)

This function allows for 3 different bass type settings. Select the one that appeals to you the most.

1 Press and hold **CENTER f** for at least 2 seconds to set the bass type.

2 Press **◀◀** or **▶▶** within 15 seconds to select the desired type (1 through 3).

TYPE 1 will sound best if you have a subwoofer in your system. Use TYPE 2 or 3 if you are using small diameter speakers.

3 Press and hold **CENTER f** for at least 2 seconds to return to normal mode.

- Bass centre frequency and bass band width previously set are replaced when selecting TYPE 1 through 3. When bass type is set to OFF, your previous settings are restored.
- Bass type is not selectable when connected to an external audio processor.
- When you press **DISP/B.OUT** on the CDA-9812RX, you can switch the level Indicator display to the BASS adjustment display. For details, see "Changing the Audio Level Display Pattern" (page 7).

Adjusting the built-in Crossover (CDA-9812RX/CDA-9811R only)

The High and Low Pass Filters on this unit can be adjusted to suit your personal taste.

1 Press and hold **T.CORR/X-OVER** for at least 2 seconds.

HPF – <Press momentarily> → LPF* – <Press momentarily> → normal mode – <Press and hold for 2 seconds> → HPF

* When the subwoofer output of this unit is turned off, LPF and phase are deactivated.

2 Press **◀◀** or **▶▶** to select the desired setting.

HPF (Setting the High Pass Filter):

FLAT (OFF) ↔ 80Hz ↔ 120Hz ↔ 160Hz

All frequencies above the selected cutoff are output.

LPF (Setting the Low Pass Filter):

FLAT (OFF) ↔ 80Hz ↔ 120Hz ↔ 160Hz

All frequencies below the selected cutoff are output.

(Only available when using the subwoofer output from this unit.)

- If no operation is performed within 15 seconds, the setup menu returns to normal mode.
- These functions are inoperative when an external, Ai-NET processor is connected.
- The Bass and Treble controls effectiveness in modifying the sound, depends on their settings and where the HPF and LPF are set.
- Except when the HPF and LPF is turned OFF, the subwoofer is in monaural mode.
- When the subwoofer is set to OFF, LPF mode and change of phase does not work.

Equalizer Presets (CDA-9815RB/CDA-9813R only)

3 typical equalizer settings are preset at the factory for a variety of musical source material.

1 Press **EQ** and select the EQ mode.

2 Press either **◀◀** or **▶▶**.

With each press of the button, the equalizer mode will display the selected equalizer characteristic.

FLAT(OFF) → POPS → ROCK → NEWS → FLAT(OFF)

FLAT : Flat frequency

POPS : Emphasize midrange

ROCK : Emphasize lows and highs

NEWS : Boost midrange and suppress highs and lows

Selecting directly

Select the desired button (1 through 4).

[1]: FLAT(OFF) [3]: ROCK

[2]: POPS [4]: NEWS

3 Press **EQ** to return to normal mode.

- This function is inoperable when DEFEAT is set to ON (page 17).
- EQ mode is automatically cancelled if no operation is performed within 15 seconds.
- When you press **DISP/B.OUT**, you can switch the Level Indicator display to the EQ Adjustment display. For details, see "Changing the Audio Level Display Pattern" (page 7).

Adjusting and Storing the Equalizer Curve (CDA-9815RB/CDA-9813R only)

You can modify the Equalizer settings to create a response curve more appealing to your personal taste.

- 1 Press **EQ** to select the EQ mode.
- 2 Press and hold **EQ** for at least 2 seconds.
- 3 Press **BAND/TEL.** to select your desired frequency band.
BAND1 → BAND2 → BAND3 → BAND4 → BAND5 → BAND1

The initial setting of each BAND is as follows.

Frequency
BAND1: 50 Hz, BAND2: 250 Hz, BAND3: 1.0 kHz,
BAND4: 3.2 kHz, BAND5: 10 kHz

Level
BAND1-5: ±0

Width (Q)
BAND1-5: 1

- 4 Press **◀◀** or **▶▶** to select your desired frequency.
Adjustable frequency bands:
20Hz to 20kHz (in 1/3 octave steps)
- 5 Turn the **Rotary encoder** to adjust the level.
- 6 Press **SOURCE/POWER** to select your desired band width (Q).
Adjustable band width: 1, 2, 3.

To store the adjusted curve

- 1) Press and hold any one of the preset buttons (1 through 6) into which you wish to store the adjusted curve for at least 2 seconds.

- 7 To set another channel, repeat steps 3 to 6.
- 8 After setting, press **EQ** to return to normal mode.

- The frequencies of adjacent bands cannot be adjusted within 4 steps.
- EQ mode is automatically cancelled if no buttons are pressed within 15 seconds.
- This function is inoperable when DEFEAT is set to ON (page 17).
- When you press **DISP/B.OUT**, you can switch the Level Indicator display to the EQ Adjustment display. For details, see "Changing the Audio Level Display Pattern" (page 7).

Recalling the Stored Equalizer Curve (CDA-9815RB/CDA-9813R only)

- 1 Press **EQ** to select EQ mode.
- 2 Press and hold **EQ** for at least 2 seconds.
- 3 Press any one of the **preset buttons (1 through 6)** to activate your desired curve.
- 4 Press **EQ** to return to normal mode.

- EQ mode is automatically cancelled if no operation is performed within 15 seconds.
- This function is inoperable when DEFEAT is set to ON (page 17).
- If you do not adjust the factory settings of (FLAT/POPS/ROCK/NEWS), the factory set display (FLAT/POPS/ROCK/NEWS) is shown preferentially.

About the Crossover (CDA-9815RB/CDA-9813R only)

Crossover:

This unit is equipped with an active crossover. The crossover limits the frequencies delivered to the outputs. Each channel is controlled independently. Thus, each speaker pair can be driven by the frequencies for which they have been optimally designed. The crossover adjusts the HPF (high pass filter) or LPF (low pass filter) of each band, and also the slope (how fast the filter rolls off the highs or lows).

Adjustments should be made according to the reproduction characteristics of the speakers. Depending on the speakers, a passive network may not be necessary. If you are unsure about this point, please consult your authorized Alpine dealer.

2 way mode

	Cut-off frequency (1/3 octave steps)		Slope		Level
	HPF	LPF	HPF	LPF	
Low range speaker	----	20 Hz - 200 Hz	----	FLAT, -6, -12, -18, -24 dB/oct	0 to -12 dB
Rear high range speaker	20 Hz - 200 Hz	----	FLAT, -6, -12, -18, -24 dB/oct	----	0 to -12 dB
Front high range speaker	20 Hz - 200 Hz	----	FLAT, -6, -12, -18, -24 dB/oct	----	0 to -12 dB

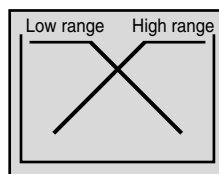

(Different from actual display)

3 way mode

	Cut-off frequency (1/3 octave steps)		Slope		Level
	HPF	LPF	HPF	LPF	
Low range speaker	----	20 Hz - 200 Hz	----	FLAT, -6, -12, -18, -24 dB/oct	0 to -12 dB
Mid range speaker	20 Hz - 200 Hz	20 Hz - 20 kHz	FLAT, -6, -12, -18, -24 dB/oct	FLAT, -6, -12, -18, -24 dB/oct	0 to -12 dB
High range speaker	1 kHz - 20 kHz	----	-6, -12, -18, -24 dB/oct	----	0 to -12 dB

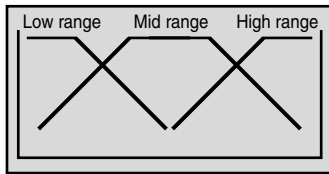

(Different from actual display)

Level adjusting (0 to -12 dB)

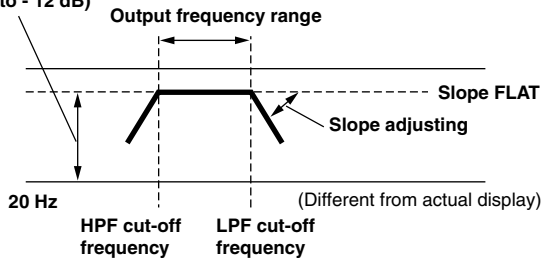

(Different from actual display)

- **HPF (high pass filter):** Cuts the lower frequencies and allows the higher frequencies to pass.
- **LPF (low pass filter):** Cuts the higher frequencies and allows the lower frequencies to pass.
- **Slope:** The level change (in dB) for a frequency change of one octave.
- The higher the slope value, the steeper the slope becomes.
- Adjust the slope to **FLAT** to bypass the HP or LP filters.
- Do not use a tweeter without the HPF on or set to a low frequency, as it may cause damage to the speaker due to the low frequency content.
- You cannot adjust the crossover frequency higher than the HPF or lower than the LPF.
- Adjustment should be made according to the recommended crossover frequency of the connected speakers. Determine the recommended crossover frequency of the speakers. Adjusting to a frequency range outside that recommended may cause damage to the speakers.

For the recommended crossover frequencies of Alpine speakers, refer to the respective Owner's Manual.

We are not responsible for damage or malfunction of speakers caused by using the crossover outside the recommended value.

Adjusting and Storing the Crossover Settings (CDA-9815RB/CDA-9813R only)

Before performing the following procedures, refer to "About the Crossover" (Page 19).

- 1 Press and hold **T.CORR/X-OVER** for at least 2 seconds.

2 WAY System

- 2 Press **BAND/TEL.** to select desired parameter.

LOW (Subwoofer) → REAR → FRONT → LOW (Subwoofer)

- 3 Press **◀◀** or **▶▶** to select desired cut-off frequency point (crossover point).

Adjustable frequency bands: 20Hz to 200Hz (in 1/3 octave steps)

- 4 Press **SOURCE/POWER** to select desired slope.

Adjustable slope: 0 (FLAT (OFF)), 1 (-6dB/oct), 2 (-12dB/oct), 3 (-18dB/oct), 4 (-24dB/oct).

- 5 Turn the **Rotary encoder** to select the desired output level.

Adjustable output level: -12 to 0 dB.

To store the adjusted contents

- 1) Press and hold any one of the preset buttons (1 through 6) for at least 2 seconds into which you wish to store the adjusted contents.

- 6 For setting another channel, repeat the steps 2 to 5.

- 7 After setting, press **T.CORR/X-OVER** to return to normal mode.

- Crossover mode is automatically cancelled if no operation is performed within 15 seconds.

3 WAY System

- 2 Press **BAND/TEL.** to select desired parameter.

LOW → MID-L → MID-H → HIGH (HI) → LOW

- 3 Press **◀◀** or **▶▶** to select desired cut-off frequency point (crossover point).

Adjustable frequency bands:

LOW : 20Hz to 200Hz (in 1/3 octave steps)

MID-L : 20Hz to 200Hz (in 1/3 octave steps)

MID-H : 20Hz to 20kHz (in 1/3 octave steps)

HIGH : 1kHz to 20kHz (in 1/3 octave steps)

- 4 Press **SOURCE/POWER** to select the desired slope.

Adjustable slope: 0 (FLAT* (OFF)), 1 (-6dB/oct), 2 (-12dB/oct), 3 (-18dB/oct), 4 (-24dB/oct).

* FLAT cannot be set for the HIGH slope.

- 5 Turn the **Rotary encoder** to select the desired output level.

Adjustable output level: -12 to 0 dB.

To store the adjusted contents

- 1) Press and hold any one of the preset buttons (1 through 6) for at least 2 seconds into which you wish to store the adjusted contents.

6 For setting another channel, repeat the steps 2 to 5.

7 After setting, press **T.CORR/X-OVER** to return to normal mode.

- About the 2way/3way system
You can switch to 2way/3way system mode with the 2way/3way switch on the side of the unit (page 44).

When setting to "3 WAY":
The unit can be operated in a 3 way system.

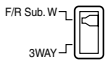

When setting to "F/R/Sub.W":
The unit can be operated in a 2 way system.

- Crossover mode is automatically cancelled if no operation is performed within 15 seconds.
- When you press **DISP/B.OUT**, you can switch the level Indicator display to the X-OVER adjustment display. For details, see "Changing the Audio Level Display Pattern" (page 7).

Recalling the Stored Crossover Settings (CDA-9815RB/CDA-9813R only)

- 1 Press and hold **T.CORR/X-OVER** for at least 2 seconds.
- 2 Press any one of the preset buttons (1 through 6) that has your desired crossover settings in memory.
- 3 Press **T.CORR/X-OVER** to return to normal mode.

- Crossover mode is automatically cancelled if no operation is performed within 15 seconds.

About Time Correction

The distance between the listener and the speakers in a car vary widely due to the complex speaker placement. This difference in the distances from the speakers to the listener creates a shift in the sounds image and frequency characteristics. This is caused by the time delay between the sound reaching the listener's right versus the left ear. To correct this, the CDA-9815RB/CDA-9813R/CDA-9812RX/CDA-9811R is able to delay the audio signal to the speakers closest to the listener. This effectively creates a perception of increased distance for those speakers. The listener can be placed at an equal distance between the left and right speakers for optimum staging. The adjustment will be made for each speaker in 0.1 ms steps.

Example 1. Listening Position: Front Left Seat

Adjust the time correction level of the front left speaker to a high value and the rear right to zero or a low value.

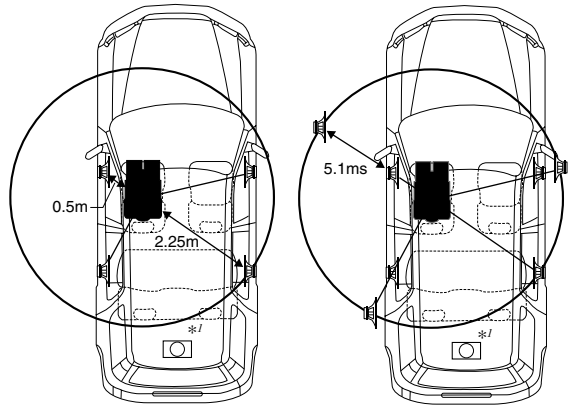

- *1 Subwoofer speaker.
CDA-9812RX/CDA-9811R only
You cannot change the Time Correction value for the subwoofer, but you can set the subwoofer's apparent position to the front by adjusting the Time Correction value of the front and rear speakers. For details, refer to the "*" on page 22.

The sound is not balanced because the distance between the listening position and the various speakers is different. The difference in distance between the front left speaker and the rear right speaker is 1.75 m (68-7/8").

Here we calculate the time correction value for the front left speaker in the diagram on the above.

Conditions:
Farthest Speaker – listening position : 2.25 m (88-9/16")
Front left speaker – listening position : 0.5 m (19-11/16")
Calculation: $L = 2.25 \text{ m} - 0.5 \text{ m} = 1.75 \text{ m (68-7/8")}$
Time correction = $1.75 \div 343^{*2} \times 1000 = 5.1 \text{ (ms)}$

*2 Speed of sound: 343 m/s (765 mph) at 20 °C

In other words, giving the front left speaker a time correction value of 5.1 ms makes it seem as if its distance from the listener is the same as the distance to the farthest speaker.

Time correction eliminates the differences in the time required for the sound to reach the listening position. The time of the front left speaker is corrected by 5.1 ms so that its sound reaches the listening position at the same time as the sound of other speakers.

Example 2. Listening Position: All Seats

Adjust the time correction level of each speaker to almost the same level.

- 1 Sit in the listening position (driver's seat, etc.) and measure the distance (in meters) between your head and the various speakers.
- 2 Calculate the difference between the distance to the farthest speaker and the other speakers.
 $L = (\text{distance to farthest speaker}) - (\text{distance to other speakers})$
- 3 Divide the distances calculated for the speakers by the speed of sound (343 m/s (765 mph) at 20 °C).
These values are the time correction values for the different speakers.

Bass Focus

The time difference between the front-rear/left-right speakers, can be adjusted at the same time. With an initial delay of 0.1 ms for each of the 0 to 99 steps, audible time correction can be done.

1 Press **T.CORR/X-OVER** to select the Bass Focus mode.

Bass Focus mode → Time correction mode → normal mode
→ Bass Focus mode

2 Press **BAND/TEL.** to select the speakers to be adjusted (see below).

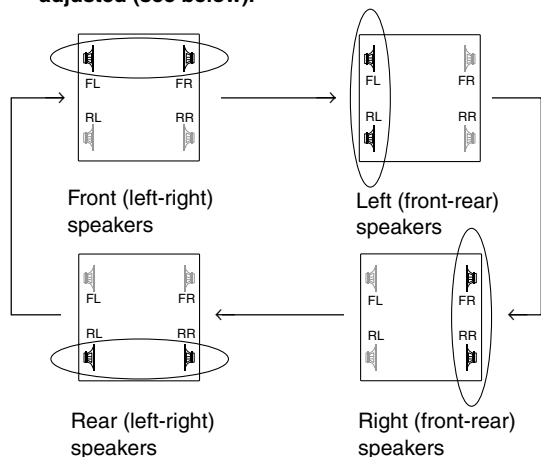

3 Turn the **Rotary encoder** to adjust the delay (see Time Difference Table).

4 To set another channel (speakers), repeat steps 2 and 3.

5 After setting, press and hold **T.CORR/X-OVER** for at least 2 seconds to return to normal mode.

- Any manual time correction adjustments will also affect corrections made in Bass Focus.
- Bass Focus mode is automatically cancelled if no operation is performed within 15 seconds.

Example setting for steps 2 and 3

(1) Press **BAND/TEL.** to select the front (left and right) speakers. Then turn the Rotary encoder to select 1.5 ms (Delay no. 15 in the table). The time difference is 1.5 ms for both front (left and right) speakers.

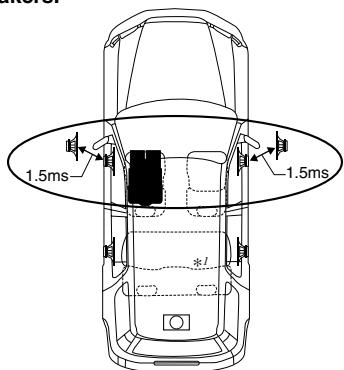

(2) Press **BAND/TEL.** to select the left (front and rear) speakers. Then turn the Rotary encoder to select 1.5 ms (Delay no. 15 in the table). The time difference is 3.0 ms^{*2} for the front left speaker, and 1.5ms for the left rear speaker, creating the impression of an equal listening between the front left speaker and the other speakers.

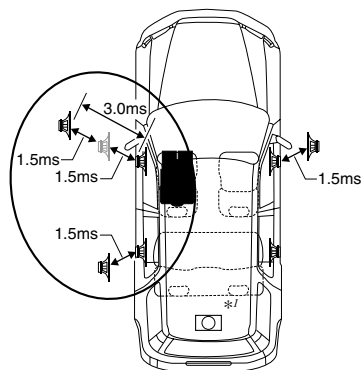

^{*1} Subwoofer speaker.

CDA-9812RX/CDA-9811R only

Delay (turn the **rotary encoder**) the audio signal to the front (left and right) speakers to make the apparent position of the subwoofer to be at the front. In doing this, the apparent position between the front (left and right) speakers and subwoofer will appear equal to the driver. After performing the above, you can change the positions of the left and right speakers by delaying the time.

^{*2} Because the time difference was already set to 1.5ms for the front left speaker to begin with, the additional correction of 1.5ms makes the total time difference of the front left speaker 3.0ms.

Time Difference Table

Delay Number	Time Difference (ms)	Delay Number	Time Difference (ms)	Delay Number	Time Difference (ms)
0	0.0	14	1.4	28	2.8
1	0.1	15	1.5	29	2.9
2	0.2	16	1.6	30	3.0
3	0.3	17	1.7	31	3.1
4	0.4	18	1.8	32	3.2
5	0.5	19	1.9	33	3.3
6	0.6	20	2.0	34	3.4
7	0.7	21	2.1	35	3.5
8	0.8	22	2.2	36	3.6
9	0.9	23	2.3	37	3.7
10	1.0	24	2.4	38	3.8
11	1.1	25	2.5	39	3.9
12	1.2	26	2.6	40 - 98	4.0 - 9.8
13	1.3	27	2.7	99	9.9

Adjusting and Storing the Time Correction (Storing available on CDA-9815RB/CDA-9813R only)

Before performing the following procedures, refer to "About Time Correction" (page 21).

1 Press **T.CORR/X-OVER** to make time corrections.

Each press changes the mode as follows:

Bass Focus mode → Time Correction mode → normal mode
→ Bass Focus mode

2 Press **BAND/TEL.** to select a speaker to be adjusted.

CDA-9815RB/CDA-9813R

F-L → F-R → R-L → R-R → S-L → S-R → F-L

CDA-9812RX/CDA-9811R

F-L → F-R → R-L → R-R → F-L

3 Turn the **Rotary encoder** to adjust the desired time correction value.

To store the adjusted contents (CDA-9815RB/CDA-9813R only)

1) Press and hold any one of the preset buttons (1 through 6) for at least 2 seconds into which you wish to store the adjusted contents.

4 Repeat step 2 and 3 to set another speaker.

5 After setting, press and hold **T.CORR/X-OVER** for at least 2 seconds to return to normal mode.

- If no operation is performed in 15 seconds, the unit returns to normal mode.

Recalling the Stored Time Correction Settings (CDA-9815RB/CDA-9813R only)

1 Press **T.CORR/X-OVER** to make time corrections.

Each press changes the mode as follows:

Bass Focus mode → Time Correction mode → Normal mode
→ Bass Focus mode

2 Press the **preset button (1 through 6)** that has your desired time correction in memory.

3 Press and hold **T.CORR/X-OVER** for at least 2 seconds to return to normal mode.

- Time Correction mode is automatically cancelled if no operation is performed within 15 seconds.

Setting the MX Mode

MX (Media Xpander) makes vocals or instruments sound distinct regardless of the music source. The radio, CD, and MP3, will be able to reproduce the music clearly even in cars with a lot of road noise.

1 Press **MX** to select **MX ON**.

2 Press **SOURCE/POWER** to select the source to which you want to apply MX (Media Xpander).

3 Press and hold **MX** for at least 2 seconds to activate the level setting mode.

4 Turn the **Rotary encoder** to select your preferred level or OFF.

FM (MX level 1 to 3):

The medium to high frequencies become clearer, and produces well balanced sound at all frequencies.

CD (MX level 1 to 3):

CD mode processes a large quantity of data. This data processing power takes advantage of CD quality sound sources.

MP3/WMA/DAB (MX level 1 to 3):

This corrects information that was lost at the time of compression. This reproduces a well-balanced sound close to the original.

DVD (Video CD)

(MOVIE MX level 1 to 2):

The dialogue portion of a video is reproduced more clearly.

(MUSIC MX level 1):

A DVD or Video CD contains a large quantity of data such as music clip. MX uses this data to reproduce the sound accurately.

AUX (MX level 1):

Choose the MX mode (MP3, MUSIC, or MOVIE) that corresponds to the media connected.

If two external devices are connected, a different MX mode for each media can be selected.

5 Press **Rotary encoder** to return to normal mode.

- To cancel MX mode for all music sources, press MX to turn MX off.
- MX mode is automatically cancelled if no operation is performed within 15 seconds.
- Each music source, such as radio, CD, and MP3/WMA can have its own MX setting.
- On disks with both MP3/WMA and CD-DA, when the source changes from "MP3/WMA to CD-DA" or "CD-DA to MP3/WMA", MX-mode switching may delay playback slightly.
- Setting to MX OFF sets MX mode of each music source to OFF.
- This function is inoperable when DEFEAT is set to ON.
- MX mode does not function when MX is set to ON for MW, LW radio.
- If the unit is connected to an audio processor with the MX function, such as PXA-H700, etc., the MX processing can be applied to the audio processor. In this case the audio processor needs to be adjusted. For details, refer to the Owner's Manual of the audio processor.
- When entering RDS signals, the MX operation cannot be performed.

Other Functions

DISP/B.OUT (CDA-9815RB/CDA-9813R/CDA-9812RX)
MUTE/B.OUT (CDA-9811R)

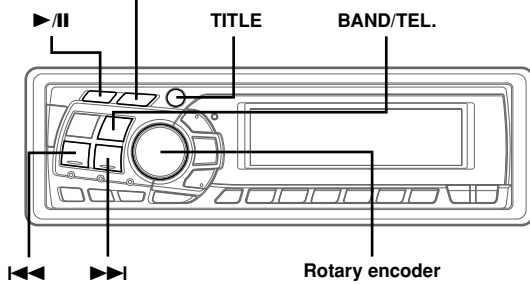

Displaying the Title/Text

It is possible to display the CD/Station title if the title has been previously inputted ("Titling Disc/Stations" page 25). Text information, such as the disc name and the track name, will be displayed if playing a CD text compatible disc. It is also possible to display the folder name, the file name, and the tag, etc., while playing MP3/WMA files.

Press TITLE.

The display will change every time the button is pressed.

The display in Radio mode:
CDA-9815RB

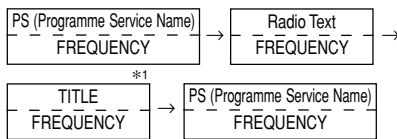

CDA-9813R/CDA-9812RX/CDA-9811R

PS (Programme Service Name) → Radio Text → TITLE → FREQUENCY → PS (Programme Service Name)

The display in CD mode (Text is displayed for the CDA-9811R model when a compatible changer with CD text is connected):
CDA-9815RB

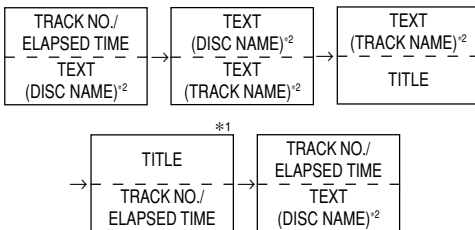

CDA-9813R/CDA-9812RX/CDA-9811R

TRACK NO./ELAPSED TIME → TEXT (DISC NAME)*2 → TEXT (TRACK NAME)*2 → TITLE → TRACK NO./ELAPSED TIME

The display in MP3/WMA mode (MP3 files can be played back with the CDA-9811R model if an MP3 compatible changer is connected):

CDA-9815RB

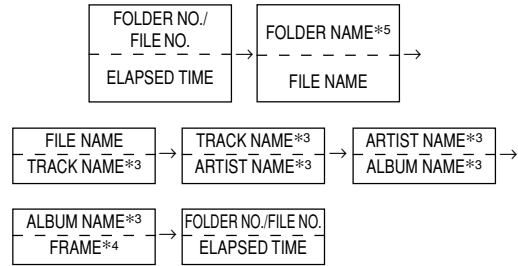

CDA-9813R/CDA-9812RX/CDA-9811R

FILE NO./ELAPSED TIME → FOLDER NO./FILE NO. → FOLDER NAME*5 → FILE NAME → TRACK NAME*3 → ARTIST NAME*3 → ALBUM NAME*3 → FRAME*4 → FILE NO./ELAPSED TIME

*1 TITLE can be input or erased.

*2 Displayed during playback of a disc with CD Text.

"NO TEXT" will be displayed when the CD contains no Text data.

*3 ID3 tag/WMA tag

If an MP3/WMA file contains ID3 tag/WMA tag information, all the ID3 tag/WMA tag information is displayed (e.g., track name, artist name, and album name). All other tag data is ignored.

"NO DATA" will be displayed when an MP3/WMA file contains no ID3 tag/WMA tag information.

*4 The recording sampling rate and bit rate of the MP3/WMA file are displayed.

*5 "-----" is displayed for the folder name of the root folder (display example: CDA-9811R).

About the indicator display

When displaying Title/Text, the following indicators are lit according to the mode.

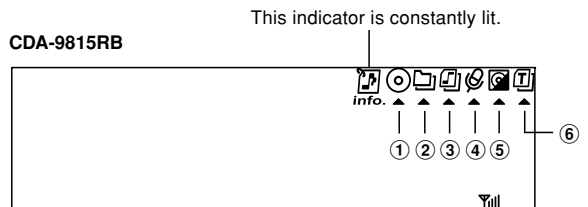

This indicator shows the strength of the telephone signal.

CDA-9813R/CDA-9812RX These indicators are lit in order of radio frequency or track number being played.

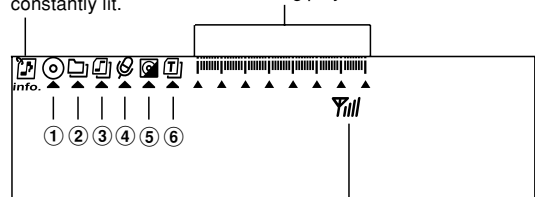

This indicator shows the strength of the telephone signal.

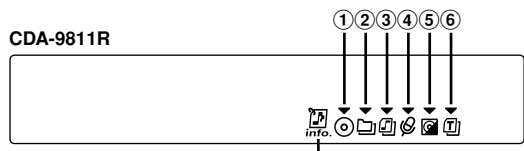

This indicator is constantly lit.

Indicator/ Mode	CD Mode	MP3/WMA Mode	TUNER Mode
①	While displaying Title	—	—
②	—	While displaying Folder Name	—
③	—	While displaying File Name	—
④	—	While displaying Artist Name*	—
⑤	While displaying Text (Disc Name)	While displaying Album Name*	—
⑥	While displaying Text (Track Name)	While displaying Track Name*	While displaying Title

*Tag information

About “Title” and “Text”

Title:

With this device, it is possible to input the CD/Station name (this page). This inputted name is referred to as a “title.” You cannot input or display titles on MP3/WMA discs.

Text:

Text compatible CDs contain text information such as the disc name and track name. Such text information is referred to as “text.”

- Some characters may not be displayed correctly with this device, depending on the character type.
- The CD changer must also be CD Text compatible for the Text information to be displayed.
- When the Scroll Setting (page 27) is set to “SCROLL MANUAL,” press and hold **TITLE** for at least 3 seconds to scroll the Text information only once (TEXT DISPLAY, FOLDER NAME DISPLAY, FILE NAME DISPLAY or TAG DISPLAY mode).
- “NO SUPPORT” (“NO SUPRT” for CDA-9811R) is displayed when the desired text information cannot be displayed on this unit.
- If the title was not previously input, “NO TITLE” is displayed.

Titling Discs/Stations

It is possible to title your favourite CD’s or radio stations. You cannot input titles on MP3/WMA discs.

1 Press **TITLE** and select the Title Display.

For details, see “Displaying the Title/Text” (page 24). For CDA-9815RB, see asterisk 1 of “Displaying the Title/Text” (page 24).

2 Press and hold **TITLE** for at least 3 seconds. The first character will blink.

CDA-9815RB only

Press **BAND/TEL.** to select the characters/symbols.

Upper case → Lower case → Numeral/Symbol
→ Upper case

3 Turn the Rotary encoder to select the desired letter/numeral/symbol available for naming.

4 Press Rotary encoder to store the first character.

The first character will stop blinking and the display will automatically advance to the next character. When that character begins to blink, you may choose the next letter or symbol of your title.



5 Repeat steps 3 and 4 above to complete the titling.

Pressing the Rotary encoder after entering the 8th character automatically stores the title into memory.

When entering a title of less than 8 characters (for example, 3 character title):

After entering 3 characters, the 4th character space will be blinking. Go to step 6 to complete the title.

6 Press **TITLE** to record the title.

- If you cancel while entering a title, selected characters are not written.
- You can enter 24 radio station titles and 18 CD titles on this unit. If you try to store beyond the limit, the display will show “FULL DATA.” At this point, no more titles can be stored. To input a new title, one of the previously inputted titles must first be deleted.
- The CD Changer title length or memory capacity varies depending upon the model being used.
- When you want to erase a title, enter the “” (“” for CDA-9815RB) symbol into all spaces.
- The operations described in steps 3 to 5 must be made within 10 seconds. The input mode will be cancelled if no action is taken for over 10 seconds.

Erasing Disc Title/Station Title

1 Press **TITLE** to select the Title Display. Then, press again and hold for at least 3 seconds.

- For CDA-9815RB, see asterisk 1 of “Displaying the Title/Text” (page 24).

2 Press and hold **▶/||** for at least 2 seconds.

The title in the display will blink.

3 Press **◀◀** or **▶▶** repeatedly until the title you want to erase is displayed.

4 Press and hold **▶/||** for at least 2 seconds to erase the title displayed.

5 Press **TITLE** to cancel the title erasing mode.

- You cannot erase CD-TEXT.
- “NO DATA” is displayed for 2 seconds if the title is not input in step 2, or if the title is erased in step 4.

Blackout Mode On and Off

When Blackout mode is turned on, the display will turn off to reduce power consumption.

This additional power enhances the sound quality.

Press and hold **DISP/B.OUT** (CDA-9815RB/CDA-9813R/CDA-9812RX) or **MUTE/B.OUT** (CDA-9811R) for at least 3 seconds to activate the blackout mode.

The display will turn off.

- If any button on the unit is pressed during the blackout mode, the function will be displayed for 5 seconds to show the operation before returning to Blackout mode.

To cancel Blackout mode, press and hold **DISP/B.OUT** (CDA-9815RB/CDA-9813R/CDA-9812RX) or **MUTE/B.OUT** (CDA-9811R) for at least 3 seconds.

i-Personalize™

Operation (CDA-9815RB/CDA-9813R only)

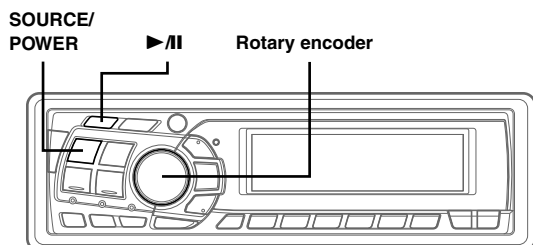

About i-Personalize™

You can download data (from Alpine's website) to a CD-R, and download and store the data to the CDA-9815RB/CDA-9813R. To start i-Personalize, access the URL below and follow the on-screen instructions.

<http://www.alpine.com> or <http://www.alpine-europe.com> or <http://www.alpine.com.au>

Downloadable data

Parametric equalizer	Data is memorized in Preset 6 of the Parametric EQ Mode.
Time correction	Data is memorized in Preset 6 of the Time Correction Mode.
Crossover	Data is memorized in Preset 6 of the crossover mode.

The file name of download data shall be "A_U*****.MP3."

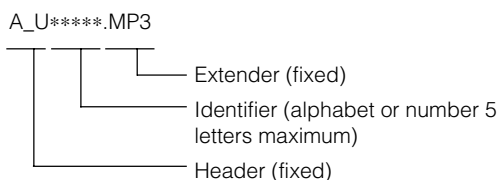

You can create a file name via the website. Do not change a file name once it has been created. Malfunction may result.

- For details about procedures of download, see ALPINE's Web site.
- If a external audio processor is connected, data that is downloaded cannot be used.

Data Downloading

- 1 Insert the CD-R disc containing the data. If the source is not the CD mode, press SOURCE/POWER to change to CD mode.**
- 2 Press and hold >|| for at least 2 seconds.**
The mode switches to the download mode to show the download confirmation screen.
- 3 Turn the Rotary encoder to select "OK", then press the Rotary encoder.**
Data search of the disc starts and the first file name is displayed.
 - Selecting "NG" will halt the download mode.
 - If a file is not found by the data search, "NO FILE" is indicated.
 - The "NO FILE" display will automatically disappear if no operation is performed for 5 seconds.
- 4 Turn the Rotary encoder to select "DOWNLOAD", and then press the Rotary encoder to start.**
Data downloading starts.

The file currently shown in the display is downloaded. If you want to download other files, select NEXT FILE to call up file names.

CANCEL : Halts the download
DOWNLOAD : Starts the download
NEXT FILE : Searches the next file

- 5 When data download is finished successfully, the confirmation screen is displayed for 5 seconds and the download mode closes.**

Successfully downloaded items are indicated as checked boxes on the confirmation screen.

PARAMETRIC EQ data

The data is memorized in Preset 6 of Parametric EQ mode. The memorized data settings in Preset 6 (Parametric EQ mode) are automatically applied.

X-OVER (Crossover) data

The data is memorized in Preset 6 of X-OVER mode. The memorized data settings in Preset 6 (X-OVER mode) are automatically applied. You cannot download the data if the setting of the 2WAY/3WAY switch is not suitable for the data.

TIME CORRECTION data

The data is memorized in Preset 6 of the Time correction mode. The memorized data settings in Preset 6 (Time Correction mode) are automatically applied.

- When you download the data again, the data is overwritten in Preset 6.

SETUP

You can flexibly customize the unit to suit your own preferences and usage. Choose the SETUP menu from Sound Customizing, Visual Customizing, etc., to select your desired setting.

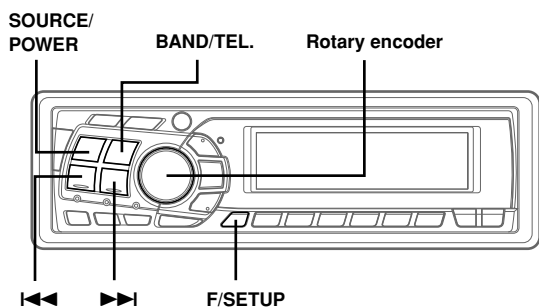

The common operation for SETUP is step 1 to 4 as follows. See down below for further information about each SETUP menu.

- 1 Press and hold **F/SETUP** for at least 3 seconds. SETUP mode is activated.
- 2 Press **◀◀** or **▶▶** to select the desired SETUP menu.
(e.g. Select BEEP)

Here is the explanation for CDA-9815RB display example.

FM-LEVEL → REG*⁵ → PI SEEK*⁵ → NORMAL/HI-FI/STABLE → AMBER*⁴ → DIMMER*⁷ → SUB-W → SUB-W STEREO/ SUB-W MONO*² → CD-DA / CD-DA/MP3*⁶ → BEEP → SCROLL → SCROLL TYPE*¹ → MUTE → INTERRUPT → AUX → (AUX name)*³ → PWR-IC → FONT*¹ → CONTRAST*¹ → DEMO → FM-LEVEL

*¹ CDA-9815RB only.

*² CDA-9815RB/CDA-9813R only.

*³ Displayed only when AUX is ON.

*⁴ CDA-9813R only

*⁵ "RDS" (page 9 to 12)

*⁶ Displayed for CDA-9811R if an MP3 compatible changer is connected.

*⁷ CDA-9815RB/CDA-9813R/CDA-9812RX only.

- 3 Press **BAND/TEL.** to change the setting.
(e.g. Select BEEP ON or BEEP OFF.)

• The Display Contrast described in the section "Adjusting Display Contrast (CDA-9815RB only)" can also be changed by turning the Rotary encoder.

- 4 Press **F/SETUP** again.
The display returns to normal mode.

Sound Customizing

Adjusting Source Signal Levels

FM-LEVEL HIGH (Initial setting) / FM-LEVEL LOW

If the difference in volume level between the CD player and FM radio is too great, adjust the FM signal level.

Switching the Tuner Mode

NORMAL (Initial setting) / HI-FI / STABLE

This unit incorporates the MAX TUNE SQ for the highest quality tuner audio. Moreover, you can choose between three settings to suit your own personal sound preferences and usage.

NORMAL: Standard setting
HI-FI: Sound quality priority setting
STABLE: Noiseless priority setting

• If you find the sound is very noisy while listening to the tuner in Hi-Fi mode, we recommend you change to Normal mode.

Subwoofer On and Off

SUB-W ON (Initial setting) / SUB-W OFF

When the subwoofer is on, perform the steps below to adjust the subwoofer output phase and level.

- 1 Press the **Rotary encoder** repeatedly to select the SUB-W mode.

SUB-W → BALANCE → FADER → DEFEAT → VOLUME → SUB-W

- 2 Press **◀◀** or **▶▶**.

The subwoofer output phase is toggled SUB-W NORMAL (0°) or SUB-W REVERS (180°).
To adjust the level, turn the Rotary encoder.

Setting the Subwoofer Output (CDA-9815RB/CDA-9813R only)

STEREO (Initial setting) / MONO

You can set the subwoofer output to stereo or monoaural. Make sure to set the correct output for your subwoofer type.

STEREO: Subwoofer stereo (L/R) output
MONO: Subwoofer monoaural output

Sound (Beep) Guide Function

BEEP ON (Initial setting) / BEEP OFF

This function will give audible feedback with varying tones depending upon the button pressed.

Visual Customizing

Changing Lighting Colour (CDA-9813R only)

AMBER ON/AMBER OFF (Initial setting)

You can change the lighting colour on the front panel.

AMBER ON: Amber colour
AMBER OFF: Green colour

Dimmer Control (CDA-9815RB/CDA-9813R/CDA-9812RX only)

DIMMER AUTO (Initial setting) / DIMMER MANUAL

Set the DIMMER control to AUTO to decrease the illumination brightness of the unit with the head lights of the vehicle ON. This mode is useful if you feel the unit's backlighting is too bright at night.

Scroll Setting

SCROLL AUTO / SCROLL MANUAL (Initial setting)

This CD player can scroll the disc and track names recorded on CD-TEXT discs, as well as the text information of MP3/WMA files, folder names, and tags. (This function can be used for CDA-9811R if a changer compatible with CD-Text is connected.)

SCROLL AUTO : The CD text information, the text information of folder and file names, and the tags are scrolled automatically.
SCROLL MANUAL : The display is scrolled only when a disc is loaded or when a track is changed, etc.

• The unit scrolls CD text names, folder names, file names or tag display. The disc titles input manually (page 25) cannot be scrolled.

Scroll Type Setting (CDA-9815RB only)

TYPE1 (Initial setting) / TYPE2

Two types of scroll can be selected.

- TYPE1: The upper line and lower line scroll alternately.
- TYPE2: The upper line and lower line scroll at the same time, but at different speeds, when the "Scroll Setting" (page 27) is set to "SCROLL AUTO."

Switching the Character Font (CDA-9815RB only)

TYPE-1 (Initial setting) / TYPE-2

Two types of font can be selected.

You can select the font type you like.

Adjusting Display Contrast (CDA-9815RB only)

CONTRAST

You can adjust the display contrast for better visibility.

You can adjust in a range of - 6 and + 6.

- The initial setting at the factory is "0."

Demonstration

DEMO ON / DEMO OFF (Initial setting)

This unit has a Demonstration feature which simulates the display functions.

- To quit Demo mode, set to DEMO OFF.

MP3

Playing MP3 Data

CD-DA (Initial setting) / CD-DA/MP3

This product can playback CDs containing both CD and MP3/WMA data. However, in some situations (some enhanced CDs), playback may be difficult. For these special cases, you can select playback of CD data only. When a disc contains both CD or the MP3/WMA data, playback starts from the CD data portion of the disc. MP3 can be played back for CDA-9811R if an MP3 compatible changer is connected.

- CD-DA : Only CD data can be played back.
- CD-DA/MP3 : Both CD data and MP3/WMA file tracks can be played back.

- Perform this setting before inserting a disc. If a disc has already been inserted, perform the setting after you remove the disc. (If you use an MP3 changer, you have to change discs.)

External Device

Turning Mute Mode On/Off

MUTE ON (Initial setting) / MUTE OFF

If a device having the interrupt feature is connected, audio will be automatically muted whenever the interrupt signal is received from the device.

Setting the AUX Mode (V-Link)

AUX ON / AUX OFF (Initial setting)

You can input TV/video sound by connecting an optional Ai-NET/ RCA Interface cable (KCA-121B) or Versatile Link Terminal (KCA-410C) to this component.

You can change the AUX name display when AUX ON is set. Select the AUX name by pressing **◀◀** or **▶▶**. Then press **BAND/TEL**. If the KCA-410C is connected, it is possible to select two AUX names.

- Via KCA-410C, up to 2 external devices with RCA output can be connected. In this case, press **SOURCE/POWER** to select AUX mode and then press **BAND/TEL**, to select your desired device.

Connecting to an External Amplifier

PWR-IC ON (Initial setting) / PWR-IC OFF

When an external amplifier is connected, sound quality can be improved by stopping the power supply of the built-in amplifier.

PWR-IC OFF : Use this mode when the front and rear pre-amplifier of the unit are used to drive an external amplifier connected to the speakers. In this setting, the head unit's internal amplifier has no output to drive speakers.

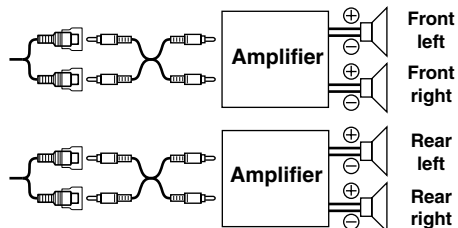

(Connecting example for CDA-9815RB)

PWR-IC ON : The speakers are driven by the built-in amplifier.

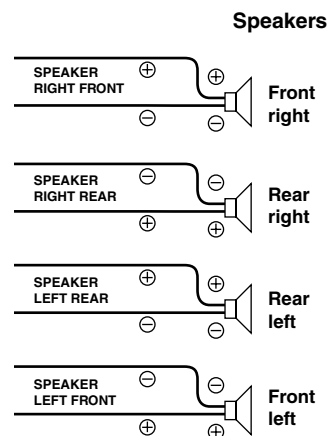

- No sound is produced by the system when the power output is set to OFF.

Setting Tone Defeat for External Devices

INTERRUPT ON / INTERRUPT OFF (Initial setting)

When inputting external devices to this unit, turning tone defeat on will bypass BASS, TREBLE, EQ and MX, i.e., sound for external devices is output at the default setting.

DAB (Optional)

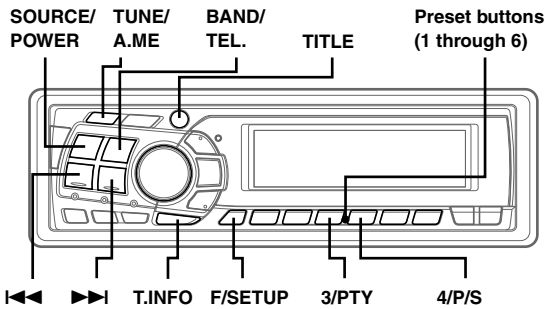

Using DAB Receiver for the Ensemble Seek Tuning (Optional)

DAB (Digital Audio Broadcasting) offers excellent sound quality even in a moving vehicle, enabling you to receive various types of information, including weather and traffic information, and it also displays information sent from the broadcasting stations. You can also let urgent broadcasts or announcements interrupt a current broadcast.

- If you connect the DAB Receiver Box TUA-T100DAB (separately sold), you can control DAB for the reception of broadcast.
- CD quality sound can be obtained from DAB broadcasts, although quality may differ on some services.
- Some broadcasting stations may perform test broadcasts.
- When DAB reception is poor, metallic noise may occur. This is not a malfunction.

- 1 Press **SOURCE/POWER** to select DAB.
- 2 Press **BAND/TEL.** to select DAB1, DAB2, or DAB3.
- 3 If you press and hold **◀◀** or **▶▶** while receiving DAB1, 2, or 3, it starts searching for ensemble automatically.

By selecting the mode in the "Changing the Display Mode" (page 31), the display shows the status of the broadcasting stations that have been received as follows:

Channel No. Display: the channel numbers of received stations are displayed.

Ensemble Label Display: the Ensemble Label of received station is displayed.

Service Label Display: the Ensemble Label is displayed for 2 seconds and then the Service Label is displayed after receiving the broadcasting station.

Component Label Display: the Ensemble Label is displayed for 2 seconds, then the Service Label is displayed for 2 seconds, and then the display is changed to the Component Label after receiving the broadcasting station.

Dynamic Label Display: the Ensemble Label is displayed for 2 seconds, then the Service Label is displayed for 2 seconds, and then the display is changed to the Dynamic Label after receiving the broadcasting station.

Frequency Display*: the frequency of received stations are displayed.

- To switch the frequency display on the CDA-9813R/CDA-9812RX/CDA-9811R, press **TITLE**. For details, see "Changing the Display Mode" (page 31).
- When you use DAB, you can select a desired ensemble which may contain one or more services, any of which can be received. Furthermore, each service contains a Service Component, which itself can contain any number of Primary or Secondary services, depending on the Service Component. Several different kinds of service can therefore be selected.

* CDA-9813R/CDA-9812RX/CDA-9811R only

Changing the Service

Services are received within the ensemble that you are currently receiving.

- 1 While receiving the ensemble, momentarily press **◀◀** or **▶▶**, and select the service that you desire. The selected service label is displayed for 2 seconds, and then you return to the display that you select with the steps described under the section "Changing the Display Mode" (page 31).

Changing the Service Component

You can change Audio Services of the Service Component between the Primary and Secondary, when listening to an Audio Service that has a Secondary Service Component.

- 1 Press **F/SETUP** so that the "FUNC" indicator lights up. (Only the underlined portion of the "FUNC" indicator for CDA-9811R.)
 - 2 Press **4/P/S** to change the Service Component between the Primary and Secondary broadcast. Every time you press the button the selection toggles. The Component label is displayed for 2 seconds, and then you return to the display that you selected with the steps described under the section "Changing the Display Mode" (page 31).
- If there exists a Secondary Service Component within a service, the indicator "S" blinks on the display. When receiving the Secondary Service Component, the indicator "S" remains lit.

Memorizing the Service

- 1 Select the service that you want to memorize.
- 2 Press any one of the **Preset buttons (1 through 6)** for at least 2 seconds while the “**FUNC**” indicator (only underlined portion of the “**FUNC**” indicator for CDA-9811R) goes out. The selected service is memorized.
- 3 To memorize more, repeat the above steps 1 and 2.

- You can memorize up to 18 stations (6 stations for each band; DAB1, DAB2, DAB3).
- If you select a preset button that has already memorized a service, the new selection takes it over.
- When you are not receiving DAB, the service is not memorized. (Memorize the service when the DAB reception is good)

Receiving the Memorized Service

- 1 Press **BAND/TEL.** to select your desired band.
- 2 Press one of the **Preset buttons (1 through 6).**

The selected service is received.

By selecting the mode in the “Changing the Display Mode” (page 31), the display shows the status of the broadcasting stations that have been received as follows:

Channel No. Display: the channel numbers of received stations are displayed.

Ensemble Label Display: the Ensemble Label of received station is displayed.

Service Label Display: the Ensemble Label is displayed for 2 seconds and then the Service Label is displayed after receiving the broadcasting station.

Component Label Display: the Ensemble Label is displayed for 2 seconds, then the Service Label is displayed for 2 seconds, and then the display is changed to the Component Label after receiving the broadcasting station.

Dynamic Label Display: the Ensemble Label is displayed for 2 seconds, then the Service Label is displayed for 2 seconds, and then the display is changed to the Dynamic Label after receiving the broadcasting station.

- Frequency Display*¹ : the frequency of received stations are displayed.
- To switch the frequency display on the CDA-9813R/CDA-9812RX/CDA-9811R, press **TITLE**. For details, see “Changing the Display Mode” (page 31).
 - When you receive the Secondary Service Component, you memorize the service, but when you call out this memorized service, the Primary Service Component will be called out.
- *¹ CDA-9813R/CDA-9812RX/CDA-9811R only

Memorizing the Ensemble Automatically

- 1 Press **BAND/TEL.** to select the band that you want to receive.
- 2 Press and hold **TUNE/A.ME** for at least 2 seconds.

The ensemble is searched for, and six ensembles are automatically received and memorized with the preset buttons (1 through 6).

When memorization has completed, the Ensemble that was memorized last is received.

By selecting the mode in the “Changing the Display Mode” (page 31), the display shows the status of the broadcasting stations that have been received as follows:

Channel No. Display: the channel numbers of received stations are displayed.

Ensemble Label Display: the Ensemble Label of received station is displayed.

Service Label Display: the Ensemble Label is displayed for 2 seconds and then the Service Label is displayed after receiving the broadcasting station.

Component Label Display: the Ensemble Label is displayed for 2 seconds, then the Service Label is displayed for 2 seconds, and then the display is changed to the Component Label after receiving the broadcasting station.

Dynamic Label Display: the Ensemble Label is displayed for 2 seconds, then the Service Label is displayed for 2 seconds, and then the display is changed to the Dynamic Label after receiving the broadcasting station.

Frequency Display*² : the frequency of received stations are displayed.

- To switch the frequency display on the CDA-9813R/CDA-9812RX/CDA-9811R, press **TITLE**. For details, see “Changing the Display Mode” (page 31).
- If no ensemble is received, the one that has been received before you perform this automatic memorization is received.

*² CDA-9813R/CDA-9812RX/CDA-9811R only

PTY (Programme Type) Tuning

- 1 Press **F/SETUP** so that the “**FUNC**” indicator lights up. (Only the underlined portion of the “**FUNC**” indicator for CDA-9811R.)
- 2 Press **3/PTY** to go to the PTY Select mode.
- 3 Press **◀◀** or **▶▶** to select your desired programme type.
- 4 After selecting a programme type, and when the “**FUNC**” indicator lights up (only the underlined portion of the “**FUNC**” indicator for CDA-9811R), press **3/PTY** to go to the PTY Search mode.

- To cancel the PTY Search mode during the PTY search, press the **PTY** button.

- 5 When the station is received, the received programme type is displayed for 5 seconds. If no station is found, “**NO PTY**” is displayed for 5 seconds.

- Above functions can be performed only for services within an Ensemble.

Turning ON/OFF Traffic News Announcement

When you set to ON, you can automatically receive the Traffic News.

1 Press **T.INFO** to set ON/OFF for the Traffic News.

You can also set the RDS stations at the same time.

- This operation can also be performed by turning the Traffic News ON/OFF in the "Setting the Announcement Select Mode" on this page.

Setting the Announcement Select Mode

1 Press **T.INFO** for at least 2 seconds to turn ON the Announcement Select mode.

2 Press **◀◀** or **▶▶** to select "ANNOUN," and then press **BAND/TEL.** to set it ON.

3 After turning ON the "ANNOUN," press **◀◀** or **▶▶** to select your desired Announcement.

Announcement → All Select → Traffic News → Travel News → Warning → News → Weather → Event → Special Event → Radio Info → Sports news → Financial news → Announcement

4 Press **BAND/TEL.** to set ON/OFF for the selected Announcement.

Repeat Steps 3 and 4 to set more.

5 To set the Announcement Select mode OFF, press **T.INFO** for at least 2 seconds.

- When one of the selections between "All Select" and "Financial news" is set ON, no announcement interrupts are made if you set OFF for the "Announcement".
- If you set ON/OFF with the "All Select" selection, you can set ON/OFF for the selections from "Traffic News" to "Financial news".
- When an urgent broadcast is received, the mode automatically changes to the DAB mode to receive the Alarm Announcement. If you adjust the volume level at this time, that volume level is memorized, and that volume level is applied the next time you receive an urgent broadcast.
- If the announcement that you select in Step 3 interrupts, the selected announcement Label is displayed. If you adjust the volume level at this time, that volume level is memorized, and that volume level is applied the next time announcement interrupts.

Changing the Display Mode

You can display information that is sent from broadcasting stations, such as the channel number or the service name that you are receiving or listening.

1 While receiving DAB, press **TITLE** to change the display mode.

Channel No. Display → Ensemble Label Display → Service Label Display → Component Label Display*¹ → Dynamic Label Display*² → Frequency Display*³ → Channel No. Display

*¹ You can display this only when the broadcasting station supplies the Service Component Label. Otherwise, "NO COMPO" is displayed.

*²

- If you set "SCROLL AUTO" for "Scroll Setting," the character information that is sent from the broadcasting station is scrolled when it displayed.

If you are set to "SCROLL MANUAL" while displaying the Dynamic Label and press and hold **TITLE** for at least 3 seconds, you can scroll the character information once.

- "NO TEXT" is displayed when broadcasting stations which contain no Dynamic Label are received. However, when a station is waiting for its reception, "WAITING" is displayed.

*³ CDA-9813R/CDA-9812RX/CDA-9811R only.

Displaying the Regional Label

The regional name of the ensemble that you are listening is displayed.

- 1 Press **TITLE** for at least 3 seconds.
"REGIONAL" is displayed for two seconds, and then the Regional Label is displayed for 5 seconds, and then you return to the display that you selected with the steps described under the section "Changing the Display Mode" on page 31.

- If no Regional Label is received, "NO REGON" is displayed.
- When you are in the Dynamic Label mode, you cannot display the Regional Label.

Receiving Announcement Information of DAB Local Stations

- 1 Press **F/SETUP** for at least 3 seconds.
- 2 Press **◀◀** or **▶▶** to select "DAB REG" ("REG").
- 3 Press **BAND/TEL.** to select ON or OFF for DAB REG.
ON: You can automatically receive announcement interruptions that are valid for the region you are currently in.
OFF: Announcement interruptions are valid for all regions.
- 4 Press **F/SETUP** to return to the normal mode.

Setting for Automatic Change from DAB to RDS

When the DAB reception is poor, you can set this selection ON to automatically change to the RDS station (a station that can be received) within the same broadcasting station until good reception is achieved. You can switch this for voice only (except Service label/Dynamic label display). The display and operation remain as for DAB.

- 1 Press **F/SETUP** for at least 3 seconds.
- 2 Press **◀◀** or **▶▶** to select "R/D SW."
- 3 Press **BAND/TEL.** to select either ON or OFF.
- 4 Press **F/SETUP** to return to the normal mode.

- When reception is being changed from DAB to RDS, the DAB indicator blinks.

Setting ON/OFF for DRC (Dynamic Range Control)

If you set this ON when receiving the sound of a wide Dynamic Range, the DRC (Dynamic Range Control) gain increases when the source sound is small, and the DRC (Dynamic Range Control) gain decreases when the source sound is large, making the Dynamic Range narrower to give you better and more comfortable sound even in the vehicle that produces a large noise.

- 1 Press **F/SETUP** for at least 3 seconds.
- 2 Press **◀◀** or **▶▶** to select "DAB DRC" ("DRC").
- 3 Press **BAND/TEL.** to select either ON or OFF.
- 4 Press **F/SETUP** to return to the normal mode.

- When a radio programme is set to ON, sound other than what you previously set may be produced depending on the broadcast. In this case, turn the programme OFF.

MobileHub™ Link Operation(Optional)

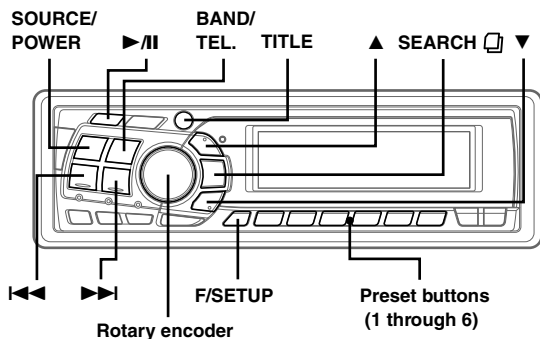

About MobileHub™ Link

Connect a separately sold junction box and a portable telephone (available from Nokia) to control the incoming and outgoing calls of the portable telephone.

Caution

Even with hands-free operation, a driver can be distracted during telephone operation or receiving a call. For the sake of safety, drivers are requested to refrain from operating the telephone while driving.

For the sake of safety, only incoming calls and Speed-Dial outgoing calls can be operated.

- If a portable telephone is connected, its address book, incoming and outgoing history are downloaded to the junction box.
- Please refer to the instruction manual of the junction box.

Telephone Mode ON/OFF

- 1 Press and hold **BAND/TEL.** for at least 2 seconds to turn on the Telephone mode.

To turn off, press **BAND/TEL.**

See relevant pages for each item.

- When a portable telephone is not connected, press and hold **BAND/TEL.** for at least 2 seconds. "NO PHONE" is displayed for about 2 seconds, then the mode returns to the original source mode.
- When the portable telephone is taken off the junction box during an incoming or outgoing call, or during a hands-free call, the call will be treated as an ordinary one by the portable telephone.
- When there is an incoming call while the power of CDA-9815RB/CDA-9813R/CDA-9812RX/CDA-9811R is off, the power of CDA-9815RB/CDA-9813R/CDA-9812RX/CDA-9811R will turn on automatically for a hands-free call.
- Even if the power of the portable telephone is off, when CDA-9815RB/CDA-9813R/CDA-9812RX/CDA-9811R is set to Telephone mode, the power of the portable telephone will be turned on.
- Even if the ACC power of the vehicle is turned off (even if the engine is stopped) during a hands-free call, the call is not disconnected, and an ordinary call by the portable telephone is possible.
- If there is an incoming call during operation (except an outgoing call or talking), operation mode will end and switch to the incoming or talking mode.

- An outgoing call from a portable telephone is also possible. However, you cannot perform different operations at the same time from a portable telephone and CDA-9815RB/CDA-9813R/CDA-9812RX/CDA-9811R as malfunction can result.
- With a junction box connected outgoing, incoming, and sending history will also be recorded in the portable telephone.
- While telephoning, defeat is set to ON. When the call has finished, the unit returns to your previous setting.
- The telephone volume can be adjusted on the CDA-9815RB/CDA-9813R/CDA-9812RX/CDA-9811R. The volume you set during the call is memorized, and is automatically applied again on the next call.
- While telephoning or receiving incoming calls, press **TITLE** to show the Network Operator display for 5 seconds.

Incoming Calls

- 1 Press **▶/II** to receive an incoming call.
- 2 Press **BAND/TEL.** to finish a call.
Telephone mode will end and return to the original source mode.

- When the Automatic Calling mode is on, you can talk after 3 seconds of receiving the incoming call.
- The incoming call can be switched to Automatic Calling or Manual Calling.

- 1 Press and hold **F/SETUP** for at least 3 seconds.
- 2 Select the Telephone mode by pressing **◀◀** or **▶▶**.
- 3 Press **BAND/TEL.** to change to AUTO or MANUAL (MANU).
- 4 Press **F/SETUP** to return to normal mode.

- Press **BAND/TEL.** during an incoming call to disconnect it.

Calling

Calling by the address book

You can call up the address book registered in the portable telephone to call from.

- 1 Press and hold **BAND/TEL.** for at least 2 seconds.
- 2 Press **SEARCH**  to select **Phone Book mode**.
A list in alphabetic order is displayed.

Retrieving an addressee by Alphabetic Sort List

- 3 When displaying the Alphabetic Sort List, turn the **Rotary encoder** or press **◀◀** or **▶▶** to select the addressee.
- 4 Press **▶/II** or **Rotary encoder** to place a call.
- 5 Press **BAND/TEL.** to end the call.
Telephone mode will end and return to the original source mode.

Retrieving an addressee by Selecting Search (A-Z search)

- 3 Press **▲** or **▼** to select an initial letter (A to Z) of the addressee.
 - 4 Turn the **Rotary encoder** to select the addressee.
 - 5 Press the **Rotary encoder** to place a call.
 - 6 Press **BAND/TEL.** to end the call.
Telephone mode will end and return to the original source mode.
- If all telephone numbers and registered names cannot be displayed at once, press **TITLE** to show undisplayed numbers and names.
 - “NO MEMORY” (“NO MEM” for CDA-9811R) is displayed if nothing is registered in the Phone Book.

Calling by using the Speed Dial

You can place a call by retrieving one of the telephone numbers registered in No. 1 to 9 of the address book.

- 1 Press and hold **BAND/TEL.** for at least 2 seconds.
 - 2 Within 5 seconds, press and hold (for at least 2 seconds) a **preset button (1 through 6)** to place a call.
By pressing **F/SETUP**, and then pressing a **preset button (1 through 3)** for at least 2 seconds, you can place a call to the number registered in 7 to 9.
- You can place a call by pressing **▶/II** after momentarily pressing the **preset button (1 through 6)** of the number you wish to call.
 - You can place a call by pressing the **Rotary encoder**, after selecting a number which you wish to call, by pressing **◀◀** or **▶▶**, or by turning the **Rotary encoder**.
- 3 Press **BAND/TEL.** to end the call.
Telephone mode will end and return to the original source mode.
- If there is no telephone number registered to a preset button, “NO PRESET” (“NO P-SET” for the CDA-9811R) is displayed when you try to place a call.

Calling by the outgoing/incoming/absent incoming history

You can place a call to any of the last 999 calls by the outgoing/incoming/absent incoming history.

- 1 Press **SEARCH**  in **Phone Book mode** to select the **History mode**.
 - 2 Press **▲** or **▼** to select outgoing history (display example: “DIALED”), incoming history (display example: “RECEIVED”), absent incoming history (display example: “MISSED”).
 - 3 Turn the **Rotary encoder**, or press **◀◀** or **▶▶** to select the addressee from the outgoing or incoming history.
 - 4 Press **▶/II** or the **Rotary encoder** to place a call.
 - 5 Press **BAND/TEL.** to end the call.
Telephone mode will end and return to the original source mode.
- If all telephone numbers and registered names cannot be displayed at once, press **TITLE** to show undisplayed numbers and names.
 - “NO MEMORY” (“NO MEM” for CDA-9811R) is displayed if there is no incoming history.

SMS (Short Message Service) Operation

You can be informed when you receive a short message.

Receiving a short message

- 1 When a text message is received, “NEW MESSAGE” for CDA-9815RB, “NEW MESSAG” for CDA-9813R/CDA-9812RX or “NEW MSG” for CDA-9811R is indicated on the display.
The contents of the received message can only be read from the portable phone’s display.
- 2 Press any one of the buttons on the unit to cancel the display. The buttons that are pressed will enter the mode or will be activated.

Changer (Optional)

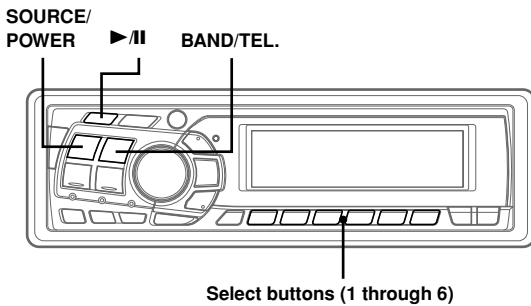

Controlling CD Changer (Optional)

An optional 6-disc or 12-disc CD Changer may be connected to this unit if it is Ai-NET compatible. With a CD Changer connected to the Ai-NET input of this unit, the CD Changer will be controllable from this unit.

Using the KCA-400C (Multi-Changer Switching device) or the KCA-410C (Versatile Link Terminal) multiple changers can be controlled by this unit.

See “Multi-Changer Selection” on this page for selecting the CD Changers.

- The controls on this unit for CD Changer operation are operative only when a CD Changer is connected.
- The DVD changer (optional) is controllable from this unit as well as the CD changer.

1 Press SOURCE/POWER to activate the CHANGER mode.

The display shows the disc number and track number.

- The source indicator varies depending on the connected source.
- Press BAND/TEL. to switch the Disc mode in the CD/Changer mode.

2 Press the disc select buttons (1 through 6) corresponding to one of the discs loaded in the CD Changer.

The selected disc number appears in the display and CD playback starts.

- After selecting the desired disc, you can operate in the same way as for the CD player of this unit.
For details, please see the CD/MP3/WMA section.
- If the “FUNC” indicator (the underlined portion of the “FUNC” indicator for CDA-9811R) is illuminated, the disc select buttons become nonfunctional.

When a 12-disc CD Changer is connected:

To select discs numbered from 1 to 6, the procedure is the same as for the 6-disc CD Changer. To select discs numbered from 7 to 12, first press F/SETUP. This changes the “D” indicator to “d.” Then press the desired preset button. With F/SETUP activated, the preset buttons 1 to 6 will represent discs 7 to 12 respectively.

Playing MP3 Files with the CD Changer (Optional)

If you connect a changer compatible with MP3, you can play CD-ROMs, CD-Rs, and CD-RWs containing MP3 files on this unit.

1 Press SOURCE/POWER to switch to the MP3 Changer mode.

2 Press any one of the disc select buttons (1 through 6) corresponding to one of the discs loaded in the CD Changer.

3 To pause playback, press ►/II. Pressing ►/II again will resume playback.

- The unit can play discs containing both audio data and MP3 data.
- For operating MP3 with an MP3 compatible CD Changer, refer to “CD/MP3/WMA” pages 13 to 16.

Multi-Changer Selection (Optional)

Alpine's Ai-NET system will support up to 6 CD Changers. When operating two or more changers, the KCA-400C (Multi-Changer Switching device) must be used. If you use 1 Switching device, you can connect up to 4 CD Changers. If you use 2 Switching devices, you can connect up to 6 CD Changers. When using KCA-410C (Versatile Link Terminal), you can connect two changers and two external outputs (AUX).

1 Press SOURCE/POWER on this unit to activate the CD Changer mode.

Alternatively, press SOURCE on the remote control (CDA-9815RB/CDA-9813R/CDA-9812RX only) to activate the CD Changer mode.

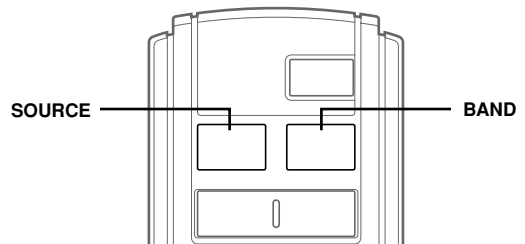

2 Press BAND/TEL. on this unit or the RUE-4187 to activate the CD Changer Selection mode.

The CD Changer Selection mode remains active for 8 seconds.

3 Press BAND/TEL. until the desired CD Changer indicator appears on the display.

Alternatively press BAND/TEL. on the Remote Control (CDA-9815RB/CDA-9813R/CDA-9812RX only) until the desired changer indicator appears on the display.

- If the selected CD Changer is not connected, the display will show “NO CHGR” (“NO CHANGER” for CDA-9815RB).
- To operate the selected changer, see “CD/MP3/WMA” (page 13).
- For further details about the external input (AUX) when using KCA-410C, see “Setting the AUX Mode (V-Link)” on page 28.

Remote Control

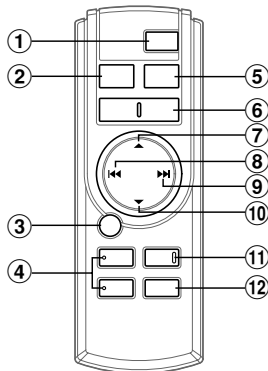

Controls on Remote Control (CDA-9815RB/ CDA-9813R/CDA-9812RX only)

- ① **Power Button**
Press this button to turn the power on/off.
- ② **Source Button**
Press this button to select the audio source.
- ③ **▶/|| Button**
Press this button to switch between the Play and Pause modes for CD.
- ④ **TILT ▼▲ Buttons**
Press this button to adjust the angle of the movable display.
- ⑤ **Band/Programme Button**
Radio mode: BAND Button
Press this button and the band will change.

CD/Changer mode: To switch the disc mode.
- ⑥ **Volume Adjustment Buttons**
To increase the volume level:
Press the button

To decrease the volume level:
Press the button
- ⑦ **▲ Button**
Radio mode: Pressing this button will select, in ascending order, stations programmed into the radio's presets as shown below.

 → ... →

CD Changer mode: DISC Select (UP) button
Press this button to select a disc in ascending order.

MP3/WMA mode: Press the Folder Select (UP) button to select the folder.
- ⑧ **◀◀ DN Button**
Radio mode: SEEK (DN) Button
CD mode: Press this button to go back to the beginning of the current track.

- ⑨ **▶▶ UP Button**
Radio mode: SEEK (UP) button
CD mode: Press this button to advance to the beginning of the next track.
- ⑩ **▼ Button**
Radio mode: Pressing this button will select, in descending order, stations programmed into the radio's presets as shown below.

 → ... →

CD Changer mode: DISC Select (DN) button
Press this button to select a disc in descending order.
MP3/WMA mode: Press the Folder Select (DN) button to select the folder.
- ⑪ **Mute Button**
Press this button to lower the volume by 20 dB instantly. Press this button again to cancel.
- ⑫ **Audio Processor Button^{*1}**
CDA-9815RB/CDA-9813R only
Each press the button to switch the audio processor mode.
For details, refer to "Operating the Audio Processor" as shown below.
CDA-9815RB/CDA-9813R/CDA-9812RX
Press the button to call the external audio processor mode when the external audio processor is connected.^{*2}

^{*1} This button is used for CDA-9812RX in conjunction with an optional Ai-NET processor.

^{*2} For the operation of external audio processor, refer to the Owner's Manual of the external audio processor you purchased.

Operating the Audio Processor (CDA-9815RB/CDA-9813R only)

1 Press A.PROC to select the mode.

Normal mode → EQ mode (Equalizer Presets) → Private mode (Recalling the Stored Equalizer Curve) → Time Correction mode (Recalling the Stored Time Correction) → Crossover mode (Recalling the Stored Crossover) → Normal mode

2 Press ▲ or ▼ to select the mode.

EQ mode
Select from FLAT, POPS, ROCK and NEWS.
Private mode/Time Correction mode/Crossover mode
Select from MEMORY 1 through 6.

Battery Replacement (CDA-9815RB/CDA-9813R/CDA-9812RX only)

Applicable battery: Use two "AAA" sized dry batteries or equivalent.

1 Opening the battery cover

Slide out the battery cover while firmly pressing in the direction of the arrow.

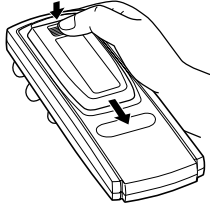

2 Replacing the battery

Insert the batteries, observing the polarities as illustrated.

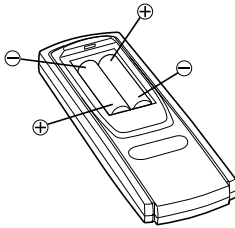

3 Closing the cover

Slide the cover as illustrated until a click is heard.

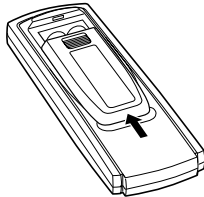

Controllable With Remote Control

The CDA-9811R can be controlled with an optional Alpine remote control. For details, consult your Alpine dealer. Point the optional remote control transmitter at the remote control sensor.

Remote control sensor

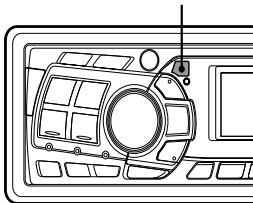

Connectable to Remote Control Interface Box

You can operate this unit from the vehicle's control unit when an Alpine Remote Control Interface Box (optional) is connected. For details, contact your Alpine dealer.

Information

In Case of Difficulty

If you encounter a problem, please turn the power off, then on again. If the unit is still not functioning normally, please review the items in the following checklist. This guide will help you isolate the problem if the unit is at fault. Otherwise, make sure the rest of your system is properly connected or consult your authorized Alpine dealer.

Basic

No function or display.

- Vehicle's ignition is off.
 - If connected following instructions, the unit will not operate with the vehicle's ignition off.
- Improper power lead connections.
 - Check power lead connections.
- Blown fuse.
 - Check the fuse on the battery lead of the unit; replace with the proper value if necessary.
- Internal micro-computer malfunctioned due to interference noise etc.
 - Press the RESET switch with a ballpoint pen or other pointed article.

Radio

Unable to receive stations.

- No antenna or open connection in cable.
 - Make sure the antenna is properly connected; replace the antenna or cable if necessary.

Unable to tune stations in the seek mode.

- You are in a weak signal area.
 - Make sure the tuner is in the DX mode.
- If the area you are in is a primary signal area, the antenna may not be grounded and connected properly.
 - Check your antenna connections; make sure the antenna is properly grounded at its mounting location.
- The antenna may not be the proper length.
 - Make sure the antenna is fully extended; if broken, replace the antenna with a new one.

Broadcast is noisy.

- The antenna is not the proper length.
 - Extend the antenna fully; replace it if it is broken.
- The antenna is poorly grounded.
 - Make sure the antenna is grounded properly at its mounting location.

CD

CD Player/Changer not functioning.

- Out of operating temperature range +50°C (+120°F) for CD.
 - Allow the vehicle's interior (or trunk) temperature to cool.

CD playback sound is wavering.

- Moisture condensation in the CD Module.
 - Allow enough time for the condensation to evaporate (about 1 hour).

CD insertion not possible.

- A CD is already in the CD player.
 - Eject the CD and remove it.
- The CD is being improperly inserted.
 - Make sure the CD is being inserted following instructions in the CD Player Operation section.

Unable to fast forward or backward the CD.

- The CD has been damaged.
 - Eject the CD and discard it; using a damaged CD in your unit can cause damage to the mechanism.

CD playback sound skips due to vibration.

- Improper mounting of the unit.
 - Securely re-mount the unit.
- The disc is very dirty.
 - Clean the disc.
- The disc has scratches.
 - Change the disc.
- The pick-up lens is dirty.
 - Do not use a commercial available lens cleaner disc. Consult your nearest ALPINE dealer.

CD playback sound skips without vibration.

- The disc is dirty or scratched.
 - Clean the disc; damaged disc should be replaced.

Error displays (built-in CD player only)

- Mechanical error
 - Press **▲**. After the error indication disappears, insert the disc again. If the above-mentioned solution does not solve the problem, consult your nearest ALPINE dealer.

CD-R/CD-RW playback not possible

- Close session (finalization) has not been performed.
 - Perform finalization and attempt playback again.

MP3/WMA

MP3 or WMA is not played back.

- Writing error occurred. The CD format is not compatible.
 - Make sure the CD has been written in a supported format. Refer to "About MP3/WMA" (page 15-16), then rewrite in the format supported by this device.

Indication for CD Player

HIGH TEMP

HI TEMP

(CDA-9815RB) (CDA-9813R/CDA-9812RX/CDA-9811R)

- Protective circuit is activated due to high temperature.
 - The indicator will disappear when the temperature returns to within operation range.

NO DISC

- No CD is inserted.
 - Insert a CD.
- Although a disc is inserted, "NO DISC" is displayed and the unit does not start to play or eject the disc.
 - Remove the disc by following these steps:
 - 1) Press the **▲** button.
The movable display will open.
 - 2) Press the **▲** button again for at least 3 seconds while the movable display is open.

ERROR

- Mechanism error.
 - 1) Press the **▲** button and eject the CD.
If not ejecting, consult your Alpine dealer.
 - 2) When the error indication remains after ejecting, press the **▲** button again.
If the error indication still does not turn off after pressing the **▲** button for a few times, consult your Alpine dealer.
- When "ERROR" is displayed:
*If that the disc cannot be ejected by pressing **▲**, press the RESET switch (refer to page 6) and press **▲** again.
If the disc still cannot be ejected, consult your Alpine dealer.*

PROTECT

(CDA-9815RB/CDA-9813R/CDA-9812RX only)

- A copy-protected WMA file was played back.
 - You can only play back non-copy-protected files.

UNSUPPORT

(CDA-9815RB/CDA-9813R/CDA-9812RX only)

- The disc is not written in a MP3/WMA supported format.
 - Use a disc written at the MP3/WMA supported format.

Indication for CD Changer

HIGH TEMP

HI TEMP

(CDA-9815RB) (CDA-9813R/CDA-9812RX/CDA-9811R)

- Protective circuit is activated due to high temperature.
 - The indicator will disappear when the temperature returns to within operation range.

ERROR - 01

- Malfunction in the CD Changer.
 - Consult your Alpine dealer. Press the magazine eject button and pull out the magazine.
Check the indication. Insert the magazine again.
If the magazine cannot be pulled out, consult your Alpine dealer.
- Magazine ejection not possible.
 - Press the magazine eject button. If the magazine does not eject, consult your Alpine dealer.

ERROR - 02

- A disc is left inside the CD Changer.
 - Press the eject button to activate the eject function. When the CD Changer finishes the eject function, insert an empty CD magazine into the CD Changer to receive the disc left inside the CD Changer.

NO MAGAZINE

(CDA-9815RB)

NO MAGAZINE

(CDA-9813R/CDA-9812RX)

NO MAGAZN

(CDA-9811R)

- No magazine is loaded into the CD Changer.
 - Insert a magazine.

NO DISC

- No indicated disc.
 - Choose another disc.

Specifications**FM TUNER SECTION**

Tuning Range	87.5 – 108.0 MHz
Mono Usable Sensitivity	0.7 μ V
Alternate Channel Selectivity	90 dB
Signal-to-Noise Ratio	65 dB
Stereo Separation	35 dB
Capture Ratio	2.0 dB

MW TUNER SECTION

Tuning Range	531 – 1,602 kHz
Sensitivity (IEC Standard)	25.1 μ V/28 dB

LW TUNER SECTION

Tuning Range	153 – 281 kHz
Sensitivity (IEC Standard)	31.6 μ V/30 dB

CD SECTION

Frequency Response	5 – 20,000 Hz (\pm 1 dB)
Wow & Flutter (% WRMS)	Below measurable limits
Total Harmonic Distortion	0.008% (at 1 kHz)
Dynamic Range	95 dB (at 1 kHz)
Signal-to-Noise Ratio	105 dB
Channel Separation	85 dB (at 1 kHz)

PICKUP

Wave length	795 nm
Laser power	CLASS I

REMOTE CONTROL**(CDA-9815RB/CDA-9813R/CDA-9812RX only)**

Battery Type	“AAA” sized dry battery
Battery Quantity	2
Dimensions (W \times H \times D)	42 mm (1-21/32") \times 121 mm (4-25/32") \times 23 mm (29/32")
Weight (without battery)	50 g (1.8 oz)

GENERAL

Power Requirement	14.4 V DC (11–16 V allowable)
Maximum Power Output	60 W \times 4
Maximum Pre-Output Voltage	4 V/10k ohms
Bass (CDA-9812RX/CDA-9811R only)	\pm 14 dB at 60 Hz
Treble (CDA-9812RX/CDA-9811R only)	\pm 14 dB at 10 kHz
Weight	CDA-9815RB/CDA-9813R 1.7 kg (3 lbs. 12 oz) CDA-9812RX/CDA-9811R 1.5 kg (3 lbs. 5 oz)

CHASSIS SIZE

Width	178 mm (7")
Height	50 mm (2")
Depth	CDA-9815RB/CDA-9813R 155 mm (6-1/8") CDA-9812RX/CDA-9811R 160 mm (6-1/4")

NOSEPIECE SIZE

Width	170 mm (6-11/16")
Height	46 mm (1-13/16")
Depth	20 mm (25/32")

- Due to continuous product improvement, specifications and design are subject to change without notice.

CAUTION

**CLASS 1
LASER PRODUCT**

(Bottom side of player)

Installation and Connections

Before installing or connecting the unit, please read the following and pages 3 to 5 of this manual thoroughly for proper use.

Warning

MAKE THE CORRECT CONNECTIONS.

Failure to make the proper connections may result in fire or product damage.

USE ONLY IN CARS WITH A 12 VOLT NEGATIVE GROUND.

(Check with your dealer if you are not sure.) Failure to do so may result in fire, etc.

BEFORE WIRING, DISCONNECT THE CABLE FROM THE NEGATIVE BATTERY TERMINAL.

Failure to do so may result in electric shock or injury due to electrical shorts.

DO NOT SPLICE INTO ELECTRICAL CABLES.

Never cut away cable insulation to supply power to other equipment. Doing so will exceed the current carrying capacity of the wire and result in fire or electric shock.

DO NOT DAMAGE PIPE OR WIRING WHEN DRILLING HOLES.

When drilling holes in the chassis for installation, take precautions so as not to contact, damage or obstruct pipes, fuel lines, tanks or electrical wiring. Failure to take such precautions may result in fire.

DO NOT USE BOLTS OR NUTS IN THE BRAKE OR STEERING SYSTEMS TO MAKE GROUND CONNECTIONS.

Bolts or nuts used for the brake or steering systems (or any other safety-related system), or tanks should NEVER be used for installations or ground connections. Using such parts could disable control of the vehicle and cause fire etc.

KEEP SMALL OBJECTS SUCH AS BATTERIES OUT OF THE REACH OF CHILDREN.

Swallowing them may result in serious injury. If swallowed, consult a physician immediately.

DO NOT INSTALL IN LOCATIONS WHICH MIGHT HINDER VEHICLE OPERATION, SUCH AS THE STEERING WHEEL OR GEARSHIFT.

Doing so may obstruct forward vision or hamper movement etc. and results in serious accident.

Caution

HAVE THE WIRING AND INSTALLATION DONE BY EXPERTS.

The wiring and installation of this unit requires special technical skill and experience. To ensure safety, always contact the dealer where you purchased this product to have the work done.

USE SPECIFIED ACCESSORY PARTS AND INSTALL THEM SECURELY.

Be sure to use only the specified accessory parts. Use of other than designated parts may damage this unit internally or may not securely install the unit in place. This may cause parts to become loose resulting in hazards or product failure.

ARRANGE THE WIRING SO IT IS NOT CRIMPED OR PINCHED BY A SHARP METAL EDGE.

Route the cables and wiring away from moving parts (like the seat rails) or sharp or pointed edges. This will prevent crimping and damage to the wiring. If wiring passes through a hole in metal, use a rubber grommet to prevent the wire's insulation from being cut by the metal edge of the hole.

DO NOT INSTALL IN LOCATIONS WITH HIGH MOISTURE OR DUST.

Avoid installing the unit in locations with high incidence of moisture or dust. Moisture or dust that penetrates into this unit may result in product failure.

Precautions

- Be sure to disconnect the cable from the (-) battery post before installing your CDA-9815RB/CDA-9813R/CDA-9812RX/CDA-9811R. This will reduce any chance of damage to the unit in case of a short-circuit.
- Be sure to connect the colour coded leads according to the diagram. Incorrect connections may cause the unit to malfunction or damage to the vehicle's electrical system.
- When making connections to the vehicle's electrical system, be aware of the factory installed components (e.g. on-board computer). Do not tap into these leads to provide power for this unit. When connecting the CDA-9815RB/CDA-9813R/CDA-9812RX/CDA-9811R to the fuse box, make sure the fuse for the intended circuit of the CDA-9815RB/CDA-9813R/CDA-9812RX/CDA-9811R has the appropriate amperage. Failure to do so may result in damage to the unit and/or the vehicle. When in doubt, consult your ALPINE dealer.
- The CDA-9815RB/CDA-9813R/CDA-9812RX/CDA-9811R uses female RCA-type jacks for connection to other units (e.g. amplifier) having RCA connectors. You may need an adaptor to connect other units. If so, please contact your authorized ALPINE dealer for assistance.
- Be sure to connect the speaker (-) leads to the speaker (-) terminal. Never connect left and right channel speaker cables to each other or to the vehicle body.

IMPORTANT

Please record the serial number of your unit in the space provided below and keep it as a permanent record. The serial number plate is located on the bottom of the unit.

SERIAL NUMBER: _____
INSTALLATION DATE: _____
INSTALLATION TECHNICIAN: _____
PLACE OF PURCHASE: _____

Installation

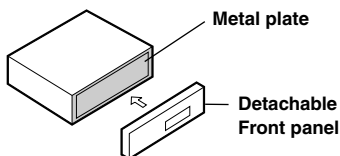

Caution

When you install this unit in your car, do not remove the detachable front panel. If the detachable front panel is removed during installation, you might press too hard and warp the metal plate that holds it in place.

Caution

Do not block the unit's fan or heat sink, thus preventing air circulation. If blocked, heat will accumulate inside the unit and may cause a fire.

Air ventilation hole

Air ventilation hole

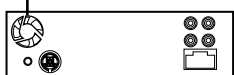

(Rear of CDA-9812RX/CDA-9811R)

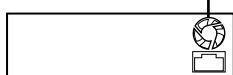

(Rear of CDA-9815RB/CDA-9813R)

1

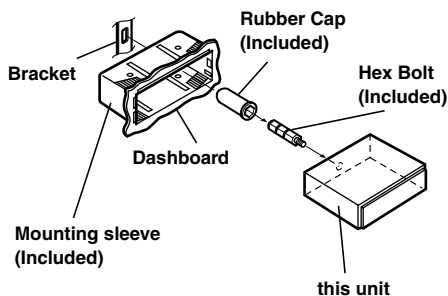

Slide mounting sleeve from main unit (see "Removal" on this page). Slide the mounting sleeve into the dashboard.

2

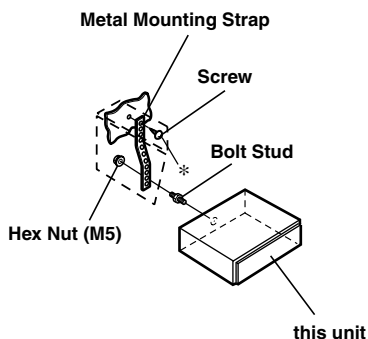

When your vehicle has the Bracket, mount the long hex bolt onto the rear panel of the CDA-9815RB/CDA-9813R/CDA-9812RX/CDA-9811R and put the Rubber Cap on the hex bolt. If your vehicle does not have the Mounting Support, reinforce the head unit with the metal mounting strap (not supplied). Connect all the leads of the CDA-9815RB/CDA-9813R/CDA-9812RX/CDA-9811R according to details described in the CONNECTION section.

- For the screw *, provide a proper screw to the chassis installing location.

- 3 Slide the CDA-9815RB/CDA-9813R/CDA-9812RX/CDA-9811R into the dashboard. When the unit is in place, make sure the locking pins are fully seated in the down position. This can be done by pressing firmly in on the unit while pushing the locking pin down with a small screwdriver. This ensures that the unit is properly locked and will not accidentally come out from the dashboard. Install the Detachable Front Panel.

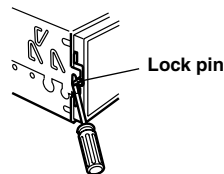

Removal

- 1 Remove the detachable front panel.
- 2 Use a small screwdriver (or similar tool) to push the locking pins to the "up" position (see above drawing). As each pin is unlocked, gently pull out on the unit to make sure it does not re-lock before unlocking the second pin.
- 3 Pull the unit out, keeping it unlocked as you do so.

<JAPANESE CAR>

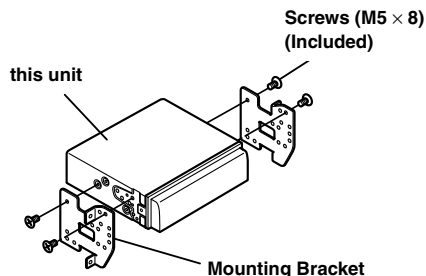
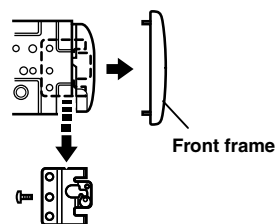

Connections for CDA-9812RX/CDA-9811R

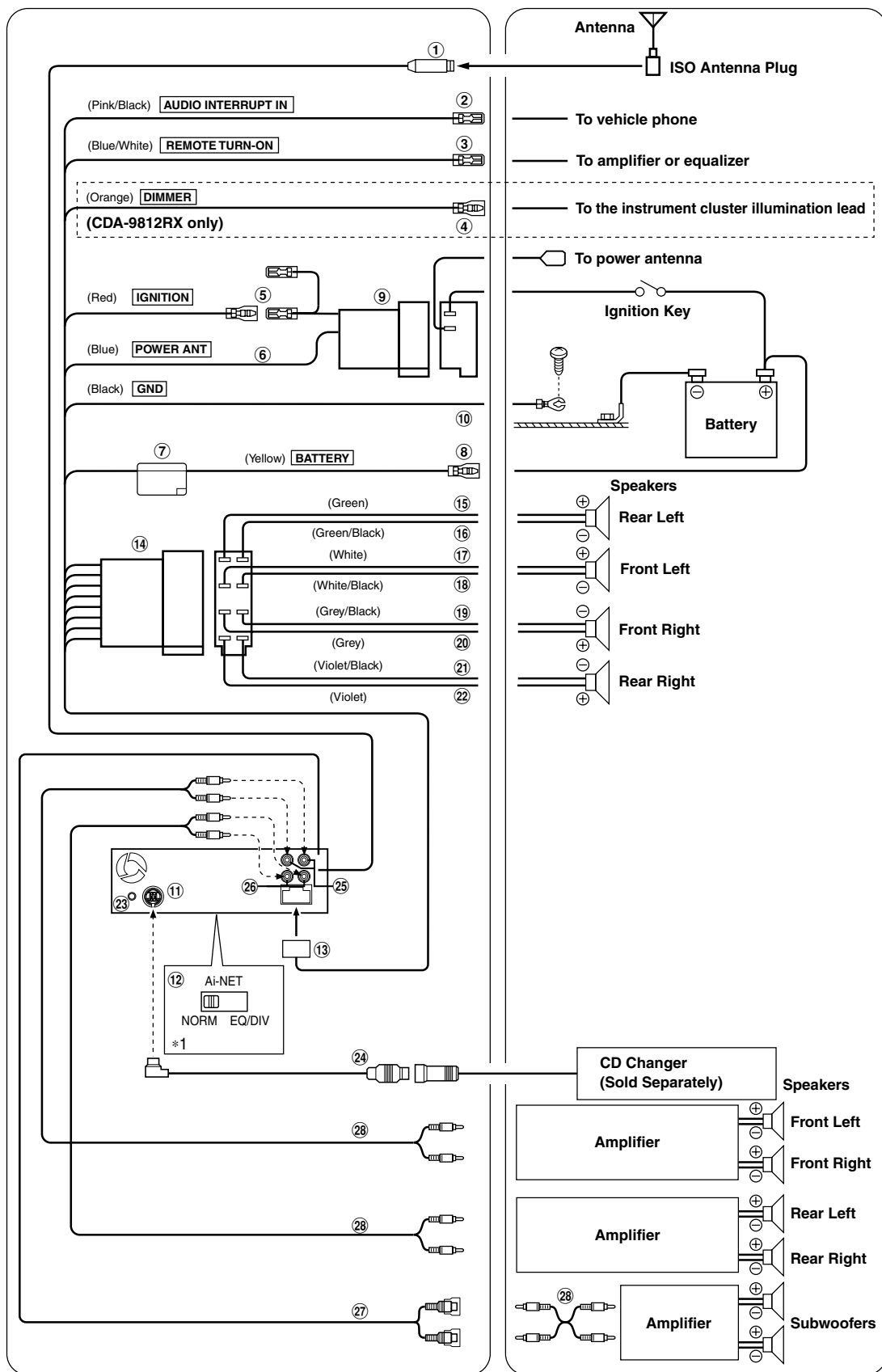

* 1 The label is attached on the bottom of the unit.

- ① **Antenna Receptacle**
- ② **Audio Interrupt In Lead (Pink/Black)**
Connect this lead to the Audio Interface output of a cellular phone which provides ground shorting when a call is received.
- ③ **Remote Turn-On Lead (Blue/White)**
Connect this lead to the remote turn-on lead of your amplifier or signal processor.
- ④ **Dimmer Lead (Orange) (CDA-9812RX only)**
This lead may be connected to the vehicle's instrument cluster illumination lead. This will enable the vehicle's dimmer control to dim the backlighting of the unit.
- ⑤ **Switched Power Lead (Ignition) (Red)**
Connect this lead to an open terminal on the vehicle's fuse box or another unused power source which provides (+) 12V only when the ignition is turned on or in the accessory position.
- ⑥ **Power Antenna Lead (Blue)**
Connect this lead to the +B terminal of your power antenna, if applicable.
 - *This lead should be used only for controlling the vehicle's power antenna. Do not use this lead to turn on an amplifier or a signal processor, etc.*
- ⑦ **Choke Coil with Fuse Holder (20A)**
- ⑧ **Battery Lead (Yellow)**
Connect this lead to the positive (+) post of the vehicle's battery.
- ⑨ **ISO Power Supply Connector**
- ⑩ **Ground Lead (Black)**
Connect this lead to a good chassis ground on the vehicle. Make sure the connection is made to bare metal and is securely fastened using the sheet metal screw provided.
- ⑪ **Ai-NET Connector**
Connect this to the output or input connector of other product (CD changer, Equalizer, etc.) equipped with Ai-NET.
- ⑫ **System Switch**
When connecting a processor using Ai-NET, place this switch in the EQ/DIV position. When no device is connected, leave the switch in the NORM position.
 - *Be sure to turn the power off to the unit before changing the switch position.*
- ⑬ **Power Supply Connector**
- ⑭ **ISO Connector (Speaker Output)**
- ⑮ **Left Rear (+) Speaker Output Lead (Green)**
- ⑯ **Left Rear (-) Speaker Output Lead (Green/Black)**
- ⑰ **Left Front (+) Speaker Output Lead (White)**
- ⑱ **Left Front (-) Speaker Output Lead (White/Black)**
- ⑲ **Right Front (-) Speaker Output Lead (Grey/Black)**
- ⑳ **Right Front (+) Speaker Output Lead (Grey)**
- ㉑ **Right Rear (-) Speaker Output Lead (Violet/Black)**
- ㉒ **Right Rear (+) Speaker Output Lead (Violet)**
- ㉓ **Remote Control Interface Connector**
To remote control interface box.
- ㉔ **Ai-NET Cable (Included with CD Changer)**
- ㉕ **Front Output RCA Connectors**
RED is right and WHITE is left.
- ㉖ **Rear Output RCA Connectors**
RED is right and WHITE is left.
- ㉗ **Subwoofer Output RCA Connectors**
RED is right and WHITE is left.
- ㉘ **RCA Extension Cable (Sold Separately)**

To prevent noise/interference in the audio system.

- Locate the unit and route the leads at least 10 cm away from the car harness.
- Keep the battery power leads as far away from other leads as possible.
- Connect the ground lead securely to a bare metal spot (remove any paint, dirt or grease if necessary) of the car chassis.
- If you add an optional noise suppressor, connect it as far away from the unit as possible. Your Alpine dealer carries various noise suppressors, contact them for further information.
- Your Alpine dealer knows best about noise prevention measures so consult your dealer for further information.

Connections for CDA-9815RB/CDA-9813R

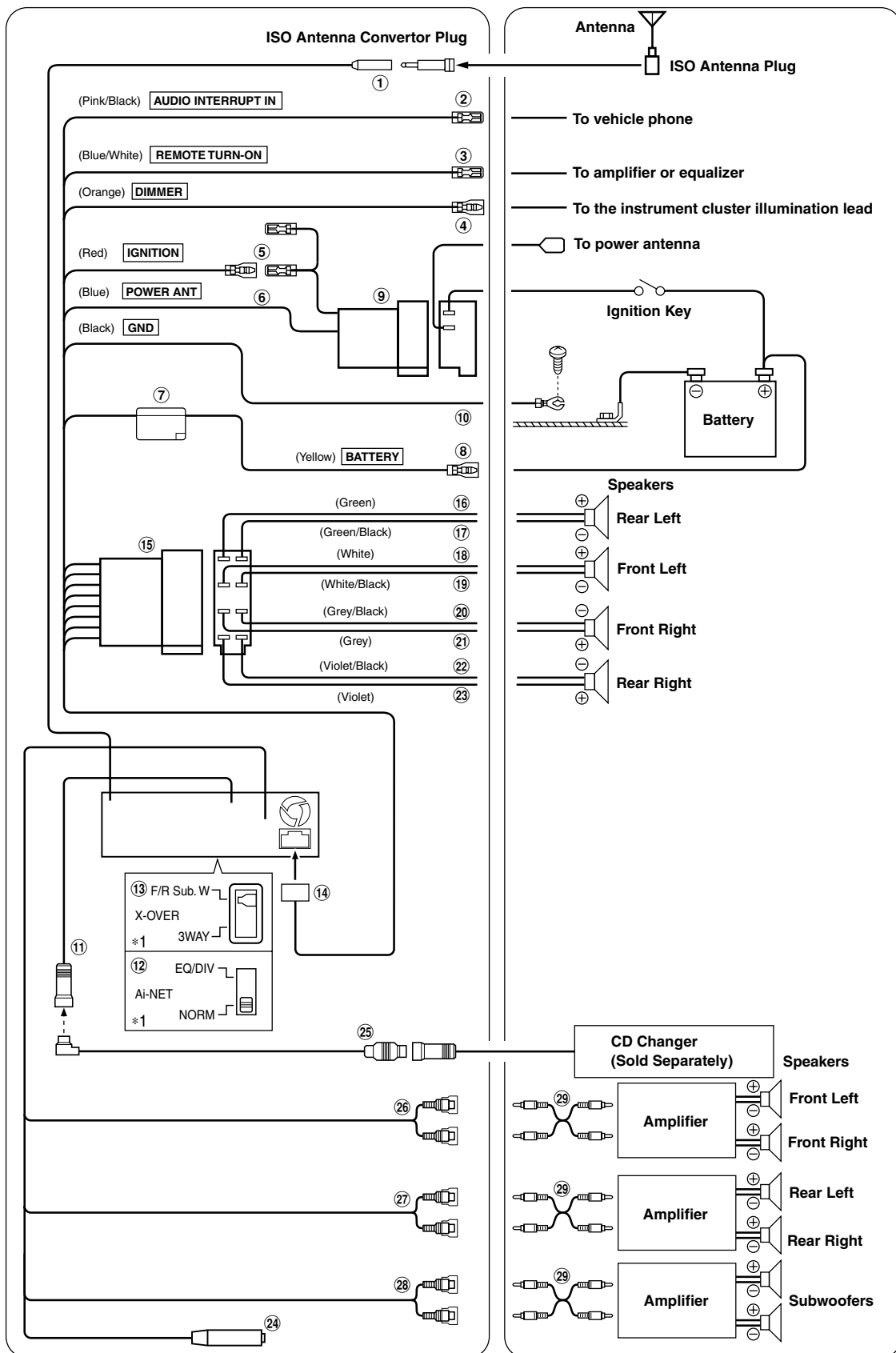

* 1 The label is attached on the bottom of the unit.

- ① **Antenna Receptacle**
Connect to the supplied ISO antenna convertor plug.
- ② **Audio Interrupt In Lead (Pink/Black)**
Connect this lead to the Audio Interface output of a cellular phone which provides ground shorting when a call is received.
- ③ **Remote Turn-On Lead (Blue/White)**
Connect this lead to the remote turn-on lead of your amplifier or signal processor.
- ④ **Dimmer Lead (Orange)**
This lead may be connected to the vehicle's instrument cluster illumination lead. This will enable the vehicle's dimmer control to dim the backlighting of the unit.
- ⑤ **Switched Power Lead (Ignition) (Red)**
Connect this lead to an open terminal on the vehicle's fuse box or another unused power source which provides (+) 12V only when the ignition is turned on or in the accessory position.
- ⑥ **Power Antenna Lead (Blue)**
Connect this lead to the +B terminal of your power antenna, if applicable.
 - This lead should be used only for controlling the vehicle's power antenna. Do not use this lead to turn on an amplifier or a signal processor, etc.
- ⑦ **Choke Coil with Fuse Holder (20A)**
- ⑧ **Battery Lead (Yellow)**
Connect this lead to the positive (+) post of the vehicle's battery.
- ⑨ **ISO Power Supply Connector**
- ⑩ **Ground Lead (Black)**
Connect this lead to a good chassis ground on the vehicle. Make sure the connection is made to bare metal and is securely fastened using the sheet metal screw provided.
- ⑪ **Ai-NET Connector**
Connect this to the output or input connector of other product (CD changer, Equalizer, etc.) equipped with Ai-NET.
- ⑫ **System Switch**
When connecting a processor using Ai-NET, place this switch in the EQ/DIV position. When no device is connected, leave the switch in the NORM position.
 - Be sure to turn the power off to the unit before changing the switch position.
- ⑬ **Setting the 3WAY/2WAY switch**
Set the 3way/2way Switch according to your audio system.
- ⑭ **Power Supply Connector**
- ⑮ **ISO Connector (Speaker Output)**
- ⑯ **Left Rear (+) Speaker Output Lead (Green)**
- ⑰ **Left Rear (-) Speaker Output Lead (Green/Black)**
- ⑱ **Left Front (+) Speaker Output Lead (White)**
- ⑲ **Left Front (-) Speaker Output Lead (White/Black)**
- ⑳ **Right Front (-) Speaker Output Lead (Grey/Black)**
- ㉑ **Right Front (+) Speaker Output Lead (Grey)**
- ㉒ **Right Rear (-) Speaker Output Lead (Violet/Black)**
- ㉓ **Right Rear (+) Speaker Output Lead (Violet)**
- ㉔ **Remote Control Interface Connector**
To remote control interface box.
- ㉕ **Ai-NET Cable (Included with CD Changer)**
- ㉖ **Front Output RCA Connectors**
RED is right and WHITE is left.
- ㉗ **Rear Output RCA Connectors**
RED is right and WHITE is left.
- ㉘ **Subwoofer Output RCA Connectors**
RED is right and WHITE is left.
- ㉙ **RCA Extension Cable (Sold Separately)**

The X-Over Switch position for a two-way system (frequency range is divided between highs for front/rear and lows for the Subwoofer).

The position of the X-Over switch : F/R/Sub-W

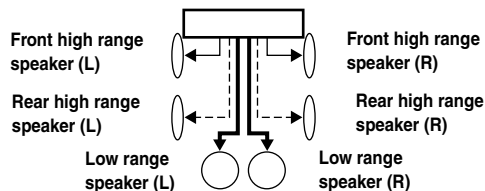

Output of this unit :



- Use the SUB-W output cord to connect the unit to the low range speaker.
- You can use the built-in amplifier to output the front output/rear output.
- You cannot adjust the fader when set to 3WAY.

The X-Over Switch position for a three-way system whose frequency range is divided among the highs (Front), mids (Rear), and lows (Subwoofer).

The position of the X-Over switch: 3WAY

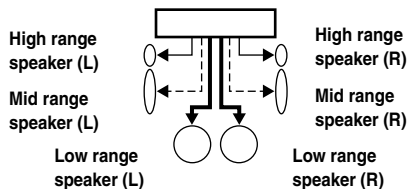

To prevent noise/interference in the audio system.

- Locate the unit and route the leads at least 10 cm away from the car harness.
- Keep the battery power leads as far away from other leads as possible.
- Connect the ground lead securely to a bare metal spot (remove any paint, dirt or grease if necessary) of the car chassis.
- If you add an optional noise suppressor, connect it as far away from the unit as possible. Your Alpine dealer carries various noise suppressors, contact them for further information.
- Your Alpine dealer knows best about noise prevention measures so consult your dealer for further information.

