

## 1 Preliminary notes

Thank you for selecting our CD/DVD car radio SilverCrest CDV-710. In order for you to utilize this device and all its options, we recommend that you read the corresponding instructions in this manual before the initial use of the device, even if you're familiar with handling electronic devices. Please pay particular attention to the chapter "Important safety instructions" on page 7. Store this manual in a safe location for future reference. If you sell or transfer this device, please be sure to pass along these instructions as well.

## 2 Copyright

The contents of this manual may not be reproduced, copied or otherwise duplicated in electronic, mechanical, magnetic, optical, chemical, manual, or any other form without the written permission of our company, nor may it be stored in a search engine, nor translated into another language.

### 3 Declaration

The descriptions and features in this manual only serve as general information and do not represent a guarantee. In order to offer you a product of the highest quality, we reserve the right to make possible improvements or changes without prior notification.

For all product descriptions and user instructions, the German version is the ultimately valid reference in the event of possible deviations in other languages.

### 4 Manufacturer information

JNC Datum Tech GmbH  
Benzstraße 33  
71083 Herrenberg  
Germany

More information can also be found at:

[www.mysilvercrest.de](http://www.mysilvercrest.de)

## 5 Table of contents

<b>1</b>	<b>Preliminary notes</b> .....	<b>1</b>
<b>2</b>	<b>Copyright</b> .....	<b>1</b>
<b>3</b>	<b>Declaration</b> .....	<b>2</b>
<b>4</b>	<b>Manufacturer information</b> .....	<b>2</b>
<b>5</b>	<b>Table of contents</b> .....	<b>3</b>
<b>6</b>	<b>Important safety instructions</b> .....	<b>7</b>
<b>7</b>	<b>Scope of delivery</b> .....	<b>11</b>
<b>8</b>	<b>Installation</b> .....	<b>13</b>
8.1	Installing the device	13
8.2	Connecting the antenna	17
8.3	Supply voltage	17
8.4	Speakers	18
8.5	Removal	19
<b>9</b>	<b>Operating unit</b> .....	<b>20</b>
9.1	Front view (closed)	20
9.2	Front view (monitor open)	22
9.3	Front view (with detached operating unit)	22
<b>10</b>	<b>Operation of the monitor</b> .....	<b>23</b>
10.1	Swivelling the monitor outward	23
10.2	Areas sensitive to touch (touch screen)	24
<b>11</b>	<b>Display</b> .....	<b>26</b>
11.1	Display when the monitor is closed	26
11.2	Display when the monitor is open	27

<b>12</b>	<b>Activation.....</b>	<b>33</b>
12.1	Insertion of the operating unit	33
12.2	Removal of the operating unit (theft protection)	34
<b>13</b>	<b>Basic functions .....</b>	<b>34</b>
13.1	Turning on/off	34
13.2	Changing the volume	35
13.3	Muting the speakers	35
<b>14</b>	<b>Radio (tuner) mode .....</b>	<b>36</b>
14.1	Selection of the radio station	36
14.2	Selection of the wavelength range	36
14.3	Searching for a radio station with the scanner	37
14.4	Manual search for a radio station	37
14.5	Storing a station with the station buttons	38
14.6	Storing stations with automatic station search	38
14.7	Calling up stored stations	38
14.8	Checking stored stations	39
14.9	LOC function	39
14.10	STMO function	40
14.11	RDS	40
14.12	Traffic announcements ("TA", traffic program, "TP")	40
14.13	Alternative frequencies ("AF")	41
14.14	Regional programs ("REG")	43
<b>15</b>	<b>CD/DVD mode.....</b>	<b>43</b>
15.1	Selecting a CD/DVD as the program source	44
15.2	Insert / remove CD	44
15.3	Playback / pause / stop	45
15.4	Selecting or repeating tracks	45
15.5	Fast forward and rewind	46

15.6	Repeating tracks (Repeat)	46
15.7	Intro	46
15.8	Playing tracks in random sequence (Random)	47
<b>16</b>	<b>SD/MMC operation .....</b>	<b>47</b>
16.1	Inserting / removing SD/MMC	47
16.2	Selecting SD/MMC as a program source	48
<b>17</b>	<b>Playing back MP3/WMA/OGG files .....</b>	<b>49</b>
<b>18</b>	<b>Displaying images.....</b>	<b>50</b>
18.1	Slide show	50
18.2	Rotating an image	50
18.3	Zoom	50
18.4	Thumbnail view	51
<b>19</b>	<b>AUX IN.....</b>	<b>51</b>
<b>20</b>	<b>Menu settings level 1 .....</b>	<b>52</b>
20.1	Changing the bass settings (BASS)	52
20.2	Changing the treble settings (TREBLE)	52
20.3	Changing the volume ratio (BALANCE)	53
20.4	Changing the volume distribution (FADER)	54
<b>21</b>	<b>Menu level 2.....</b>	<b>55</b>
21.1	LOC function to set the station search	55
21.2	LOUD function for the tone setting – loudness	56
21.3	ST – MO function to switch between stereo and mono playback	56
21.4	CT function to set the time of day	57
21.5	TAVOL function to set the volume for traffic announcements	58
21.6	EON for the automatic station switch for traffic announcements	59
21.7	D/Z for the settings of the second playback level (DUAL ZONE)	60

<b>22</b>	<b>DVD device settings</b> .....	<b>60</b>
22.1	General settings	61
22.2	Audio settings	62
22.3	Video settings	64
22.4	Preferred settings	65
22.5	Password settings	67
22.6	Exiting the settings	68
<b>23</b>	<b>Factory default settings (“RESET“)</b> .....	<b>68</b>
<b>24</b>	<b>Remote control</b> .....	<b>69</b>
24.1	Remote control (normal)	69
24.2	Remote control (Dual Zone)	70
24.3	Changing the battery	71
24.4	Disposal of the battery	72
<b>25</b>	<b>Product information</b> .....	<b>72</b>
25.1	General information	72
25.2	Technical specifications	73
<b>26</b>	<b>Disposal</b> .....	<b>76</b>
<b>27</b>	<b>Troubleshooting</b> .....	<b>77</b>

## 6 Important safety instructions

Please read and strictly observe the following instructions!



- Never open the case of the car radio; it does not contain any serviceable parts! If the case is open, there is a risk of fatality due to electric shock.
- Do not give your car radio and especially the accessories to children. Never let your children use electrical devices without supervision. Children are not always able to recognize potential hazards. Also keep the packaging films away from children. There is a danger of suffocation.
- The car radio and the accompanying components may not be exposed to dripping or sprayed water. Make sure that no containers filled with liquid, such as e.g. cups or bottles, are placed in the vicinity of the device.
- Make sure that the display is not exposed to any bumps. This could damage the display.
- Please familiarize yourself with the different functions of your device before you begin driving. Excessively high volumes can pose a risk for you and other people in traffic. Therefore always select the volume at such a level that **environmental sounds** (horns, sirens, etc.) can still be perceived.
- Don't use the car radio at an excessive volume. This poses a risk to your hearing.
- Please only perform lengthy changes of the device settings while the vehicle is parked. Your concentration might be affected by the changes.
- Only install the device in such a manner that safe driving is assured.
- Install the device in such a manner that it doesn't impede the driver and can't injure any of the vehicle's occupants in the event of emergency braking.

- Don't flip the monitor open by hand. This could damage the mechanics.
- The TFT colour monitor consists of glass and liquid crystals. Don't put any excessive pressure on the monitor, since otherwise it might scratch, break, or sustain other damages. In addition, the image quality might be impaired.
- Don't touch the monitor surface with hard objects and only clean it with a soft, dry cloth and special TFT cleaner.
- Don't use the device for a longer period while the vehicle's engine isn't running. This could drain the vehicle battery to the degree that the car can no longer be started. In addition, this might reduce the lifespan of the battery.
- Don't park your vehicle in direct sunlight for extended periods, otherwise the temperature in the car's interior could rise to the point that the device overheats and causes malfunctions. If possible, cool the interior of the vehicle in order to ensure that the device will operate properly.
- Only let the device be installed by qualified vehicle technicians.
- Before the final installation of the device into a DIN insertion compartment in the dashboard, connect the cables and test the connections.
- Only use the accessories included in the delivery. Usage of unauthorized components can cause damages.
- If you need to drill holes or make other changes for the installation, consult a specialised workshop in your area.
- This device is designed for a vehicle power supply of 12 V with the ground on the car body (negative pole). Check the battery voltage before installing it into a camping vehicle, bus, or truck.
- To avoid short circuits, the battery has to be disconnected before the installation.
- Read the guidelines in this handbook for the connection of the power supply and other options.



- Secure the installed cables with insulating tape, cable ties, or cable clamps. To protect the cables from damage, use insulating tape when guiding them past metal components.
- Place and secure all cables in such a manner that they are not in the vicinity of movable parts, such as e.g. the parking brake, gas/brake/coupling pedals, handle bars and seat tracks.
- Don't place any cables in the vicinity of heat sources (e.g. near the heater ventilation), since the insulation of the cables might get damaged and result in short circuits.
- Don't short circuit any cables. This can result in damages to the vehicle and device.
- Never establish a power supply to other devices by removing the insulation of the device's power supply and connecting an additional cable. Otherwise, the maximum power rating of the cable will be exceeded and there will be a danger of overheating.
- If you have to replace the fuse, only use an identical one with the same rating.
- The connected speakers have to be high-performance speakers with a minimum output of 40 W and an impedance ranging from 4 to 8 ohm. If you connect speakers with other output or impedance ratings, the speakers may burn, smoke, or sustain other kinds of damage.
- When the device is turned on, a control signal adjoins the blue cable of the connection A5 (ISO plug A). You can connect this to the relay of the extendable vehicle antenna (max. 500 mA, 12 V=). If your vehicle has a wire antenna inside the windshield, connect the blue cable A5 (ISO plug A) to the pre-amplifier of the antenna.
- If an external audio amplifier is connected to the device, the blue cable of connection A5 (ISO plug A) may not be connected to the power supply of the amplifier. Likewise, you may not connect it to the power supply of an active car antenna. This poses a risk of short circuits and malfunctions.
- Insulate unused connection cables with insulating tape. The same applies to unused speaker cables. Otherwise there is a risk of short circuits.

- Dirt or condensed moisture on the lens of the CD/DVD drive may impede and even prevent the playback of data carriers.
- In general, the playback of self-burned data carriers is possible, but it depends on the used software and the settings made with it, so that there may be problems during playback in individual cases. You can receive further information from the manufacturer of your software.
- Additional CD data carriers can be played back just like audio CDs.
- It's possible that CD-R/CD-RW data carriers can't be played back correctly if they were recorded by a device other than an audio CD recorder.
- In addition, it may be the case that a data carrier (CD-R/CD-RW) recorded with an audio CD recorder can't be played back due to the conditional features, irregular formats, or soiling of the data carriers.
- The information recorded on the data carrier (ID3TAG) is displayed by this device.
- After inserting a CD-RW data carrier, it takes a little longer for the playback to begin than with regular CD or CD-R data carriers. Also read the guidelines on the sleeves of the CD-R/CD-RW data carriers before you insert them.

## 7 Scope of delivery

### 1. CDV-710 CD/DVD Car radio



Monitor closed

### 2. Case for the operating unit



### 3. Installation frame



Monitor open

### 4. Disassembly key, installation material

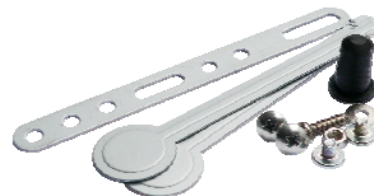

## 5. Remote control



## 6. Remote control (dual zone)



## 7. ISO connector set



## 8. User manual



### Note:

The design and technical data are subject to change without any notification. Illustrations are not true to scale.

## 8 Installation

### 8.1 Installing the device

#### Note:

Please observe the following safety instructions for the connection of the device:

- Read the entire installation section before connecting the device.
- Disconnect the negative pole of the vehicle battery for the duration of the installation.
- Observe the safety instructions by the vehicle manufacturer during this task.
- If you need to drill holes for the installation, make sure that no parts of the vehicle are damaged.
- The cross section of the positive and negative cable may not be less than 2.5 mm<sup>2</sup>.
- Do **not** connect any of the vehicle's plugs and cables to the radio unless you have the appropriate specialised knowledge of this process!
- Only use the supplied cable to connect the device.
- Depending on the build of your vehicle, the installation may deviate from this description.
- We do not assume any liability for damages caused by faulty installations or connections, nor any subsequent damages.

#### Note:

We recommend that you have the device installed by a specialised company. Then you will have created the prerequisites for a problem-free functioning of the device. If at any point during the installation you are unsure that you can correctly connect the device by yourself, contact a specialist. A faulty installation may cause damages to the device and the vehicle electronics.

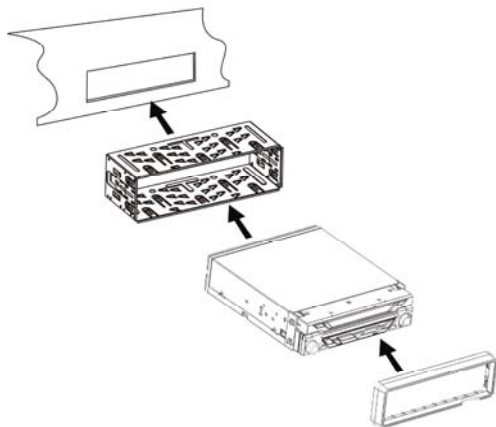

Illustr. 8.0

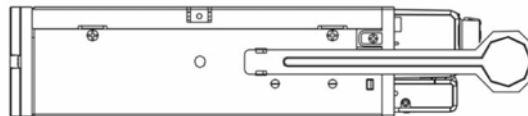

Illustr. 8.1



Illustr. 8.2

- Then remove the installation frame from the device with the aid of the disassembly key, by sliding the disassembly keys into the provided openings on the right and left side of the device, as described in illustr. 8.1. Make sure that the protrusion on the disassembly key points away from the device during the insertion (illustr. 8.2). Afterwards, the frame can be slid down over the device towards the rear.
- Now slide the installation frame into the installation slot provided for the car radio.
- Now attach the installation frame by bending the installation brackets towards the outside with a screwdriver. The frame is properly installed when it can no longer be pulled out, yet also keeps from sliding into the installation slot.
- Now connect the cable set and the antenna to the vehicle's electronics corresponding to illustr. 8.3 and illustr. 8.4 as well as the table below. Also observe the specifications in sections 8.2 to 8.4.

Contact	Connector pin assignment ISO connector plug (also see illustr. 8.3 number 7)	
	Plug A	Plug B (speaker connections)
1		Rear right (+) – violet
2	Reverse light / orange	Rear right (-) – violet / black
3		Front right (+) – grey
4	Battery 12V (+) / yellow	Front right (-) – grey / black
5	Car antenna / blue	Front left (+) – white
6		Front left (-) – white / black
7	Ignition (ACC+) / red	Rear left (+) – green
8	Ground / black	Rear left (-) – green / black

- Insert the device into the installation frame until the stop. The device then audibly snaps into the frame.
- Attach the front frame and then insert the operating unit.

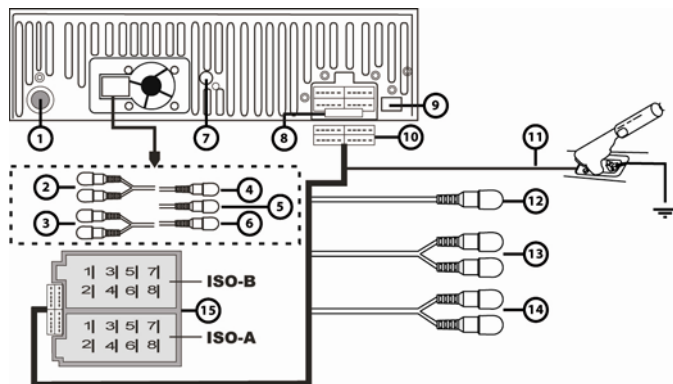

Illustr. 8.3

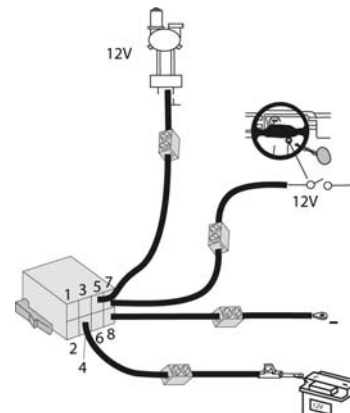

Illustr. 8.4

1	Antenna connection	9	Optical audio output
2	AUX input – right + left (brown)	10	Connector plug for ISO adapter cable set
3	Output rear – right + left (grey)	11	Drive disconnection of the video signal (brown)
4	Camera input (black)	12	Subwoofer output (black)
5	Video output rear (black)	13	Backseat line out (grey)
6	Video input (AUX IN video), black	14	Front line out (brown)
7	Bolts for the device installation	15	ISO adapter plug
8	Device fuse 15A		

RCA jack colours: left = white, right = red, other = yellow



**Caution:**

The device is distinguished by a high degree of output. During operation, this results in a strong heat generation. Therefore no cables or other parts may adjoin the device. If their insulation melts, there is the risk of a short circuit or fire.

**Note:**

The connection 8.3 shown in illustr. 8.3 with the symbol ⑫ has to be connected to the parking brake or other suitable components of the vehicle in such a way that the video playback of the device is interrupted for the driver while the vehicle is in motion. Please consider that your insurance coverage may be restricted or exempted otherwise. Please consult a specialist in your area if you have any questions about the connections.

## 8.2 Connecting the antenna

The device is designed for antennas with an impedance of 75 Ω. To connect the antenna, plug the antenna cable into the antenna socket of the device (socket ① on the rear of the device).

## 8.3 Supply voltage

### ISO plug A:

**A2 (orange):** Connection to the reverse light to switch on the rear view camera when the reverse gear is put in.

**A4 (yellow):** Connection for +12V operational voltage (diameter at least 2.5 mm<sup>2</sup>) to terminal # 30 (permanent plus) of the vehicle.

**A5 (blue):** +12V: switching voltage output (max. 0.5 A). When the device is turned on, the switching voltage adjoins contact A5 and serves to retract or extract an automatic antenna and as operational voltage for antenna amplifiers.

**A7 (red):** Connection for +12V trigger voltage. Connect to terminal # 15 of the vehicle. If contacts A4 and A7 are switched, the device will “forget” the stored stations after the ignition is turned off.

**A8 (black):** Attach the connection for the ground (diameter at least 2.5 mm) to terminal # 31 (ground) of the vehicle.

#### Note:

Depending on the manufacturer, the contacts on your vehicle connection may be assigned differently. This is not a defect of the device but caused by a deviating connector pin assignment by the manufacturer of your vehicle. To provide a connection that conforms to this device, please purchase an appropriate adapter cable from a specialised dealer if required. Please consult a specialist in your area if you have any questions about the connections.

## 8.4 Speakers

### Cable adapter ISO plug B

Maximum output for 4-8  $\Omega$  speakers:  
4 x 20W Music output

Front speakers		Back speakers		
B3:	right +	grey	B1: right +	violet
B4:	right -	grey/black	B2: right -	violet/black
B5:	left +	white	B7: left +	green
B6:	left -	white/black	B8: left -	green/black

#### Caution:

Don't attach the speaker connections to each other electrically and don't connect them to ground! This can lead to the destruction of the device. Please pay attention to illustr. 8.5 – 8.7.

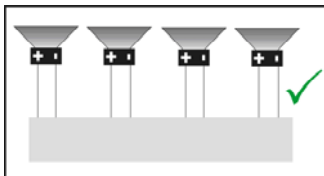

Illustr. 8.5

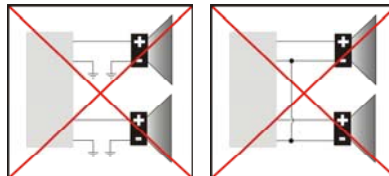

Illustr. 8.6

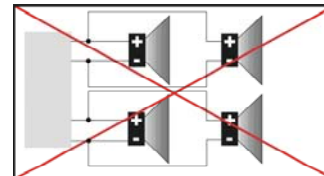

Illustr. 8.7

## 8.5 Removal

Turn off the device. Remove the operating unit and place it into the case. Clamp off the negative pole of the vehicle battery for the duration of the disassembly. First remove the front frame of the device by inserting a flat object (e.g. the back of the disassembly key) between the device and the panel to the right and left of the short side of the frame and carefully levering the panel out towards the front. Then insert the two disassembly keys into the openings on both sides of the front of the device and slide these until the stop. Make sure that the protrusion on the disassembly key, illustr. 8.2, points away from the device during the insertion. Slowly and carefully pull out the device. Remove the cable and antenna from the device.

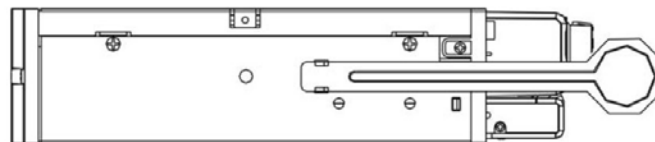

### Note:

Make sure that no vehicle cable can cause a short circuit after the device has been unplugged.

## 9 Operating unit

### 9.1 Front view (closed)

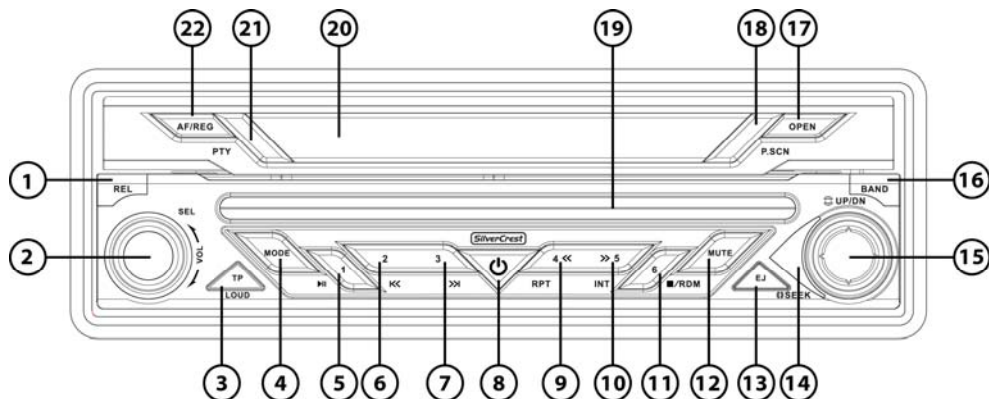

- |  |  |
|--|--|
| <p>① Button to remove the operating unit</p> <p>② - Volume control dial (turned)<br/>- Settings dial for menu level 1 – VOL, BAS, TRE, BAL, FAD (if pressed for less than two seconds)<br/>- Settings dial for menu level 2 - LOC - LOUD – STEREO/MONO - TIME - TAVOL - EON – DUAL ZONE - (if pressed for more than two seconds)<br/>- LOC is only available in radio mode</p> | <p>③ - TP button to turn the traffic alert function on/off</p> <p>- Button to activate the loudness function (pressed longer than three seconds)</p> <p>④ MODE button to select sources between radio, CD/DVD (if inserted), memory card (if inserted), rear view camera and AUX In</p> <p>⑤ - Station selection button 1 (radio mode)<br/>- Start /pause button (data carrier mode)</p> |
|--|--|

- ⑥ - Station selection button 2 (radio mode)  
- Previous track (data carrier mode)
- ⑦ - Station selection button 3 (radio mode)  
- Next track (data carrier mode)
- ⑧ Button to turn the device on / off
- ⑨ - Station selection button 4 (radio mode)  
- Repeat track (data carrier mode) if pressed longer  
- Quick rewind (data carrier mode)
- ⑩ - Station selection button 5 (radio mode)  
- Scan track "intro" (data carrier mode) if pressed longer  
- Fast forward (data carrier mode)
- ⑪ - Station selection button 6 (radio mode)  
- Random playback (data carrier mode) if pressed longer  
- Stop button (data carrier mode)
- ⑫ Button to mute the device
- ⑬ CD/DVD eject button
- ⑭ Infrared sensor for the remote controls
- ⑮ 5-Way multifunction button for the menu navigation to the right, left, up, down, and confirm (pressed)
- ⑯ BAND – Button to switch the frequency band as well as the button memory FM1 - FM3, MW1 and MW2
- ⑰ OPEN – Button to open and close the 7" monitor
- ⑱ P.SCAN – Button for the automatic station scanning and the automatic station storage
- ⑲ CD / DVD insertion slot
- ⑳ Display
- ㉑ PTY button to select the program style (e.g. jazz, pop, news, etc.)
- ㉒ AF/REG button: Alternative frequency ON/OFF and REG ON/OFF (if pressed longer)

## 9.2 Front view (monitor open)

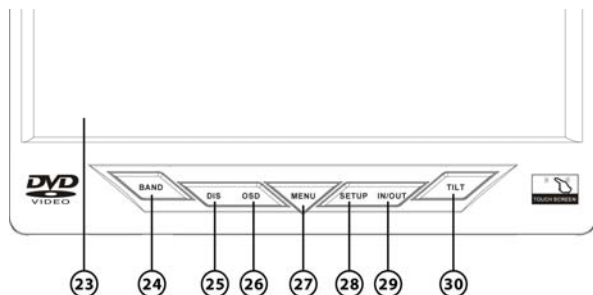

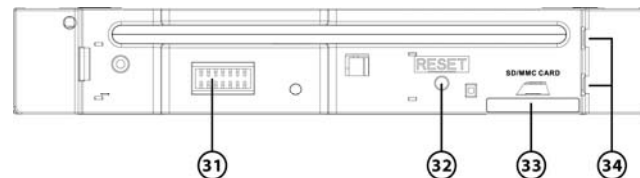

- ②③ 7" TFT monitor (touch sensitive)
- ②④ BAND – Button to switch the frequency band as well as the button memory FM1 - FM3, MW1 and MW2
- ②⑤ Button to change the display information (only in data carrier mode)
- ②⑥ Button to activate the monitor menu for the playback source and device settings
- ②⑦ Button to display the DVD playback menu (only in CD/DVD mode)
- ②⑧ Button to activate the monitor menu for the DVD device settings

## 9.3 Front view (with detached operating unit)



- ②⑨ Button to change the distance of the monitor to the installation slot
- ③① Button to set the slant of the monitor (TILT)
- ③② Contacts for the operating unit  
PLEASE DON'T TOUCH!!
- ③③ Reset button to restore factory default settings.  
Note: When the factory settings are restored, the clock and the stored radio stations will also be reset or erased
- ③④ SD/MMC card slot
- ③⑤ Right operating unit holder

## 10 Operation of the monitor

Open the monitor by briefly pressing the “OPEN” button . Now the monitor is opened automatically and fixed in the flipped-open position. The monitor can be closed again by pressing the “OPEN” button  again.

If the monitor doesn't close as a result, it may not be in the correct position. Then there will be the error message “ERROR – MONITOR NOT CENTERED!!”

### Note:

Before beginning to drive, please familiarize yourself sufficiently with the device and avoid longer entries during the drive for your own safety!

### 10.1 Swivelling the monitor outward

To better read and operate the screen, it's possible to swivel the monitor of the device by about 30° to the right and left. For this, first open the monitor with the “OPEN” button  as described above. Then you can swivel the monitor by pulling it towards you carefully from the lower right or left edge of the screen. Never use force during the process, otherwise you might damage the device. To swivel the monitor back, just press it back into the original position.

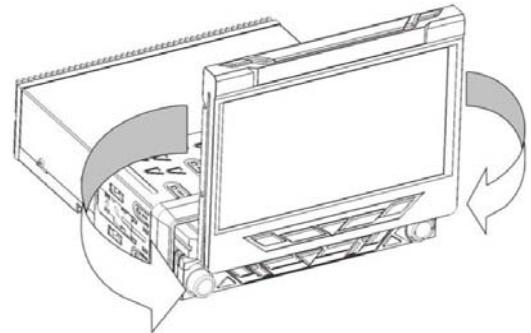

Illustr. 10.1

## 10.2 Areas sensitive to touch (touch screen)

The screen has features that are sensitive to the touch (touch screen). This makes it possible to control many functions by touching the screen. In an open position there are always two menus available. First the main menu and, in addition, the menu for the second playback level (dual zone).

The two areas indicated in illustr. 10.2 are not visible on the screen. The image merely serves for a clearer visualisation.

But if you press a finger or an object against the indicated areas, the corresponding submenu will open. The menus and their functions are addressed in the following chapter.



Illustr. 10.2

### Note:

- Please only touch the screen with very light pressure and never with sharp objects. Otherwise it might get scratched and damaged.
- When the monitor is being opened or closed, no sound will be produced during this process. This is not a malfunction of the device.



For the playback of audio, video or image data, there is also another, non-visible menu available. When touching the right edge of the screen in the area of the marked surface, the playback will jump to the next track. When touching the left edge of the screen in the area of the marked surface, the playback will jump to the previous track. At the lower edge of the screen, you will reach an additional menu by means of the marked area (see illustr. 10.4 below).

You can reach the menu pictured in illustr. 10.4 by touching the field that is indicated as "MENU" in illustr. 10.3. Then the adjoining menu is activated and makes the functions available according to their symbols. Through "EJECT" you can eject the CD/DVD data carrier. Through "EXIT" you will exit the menu and return to the display that was there prior to the activation of the menu. The menu automatically fades out ten seconds after the last entry.

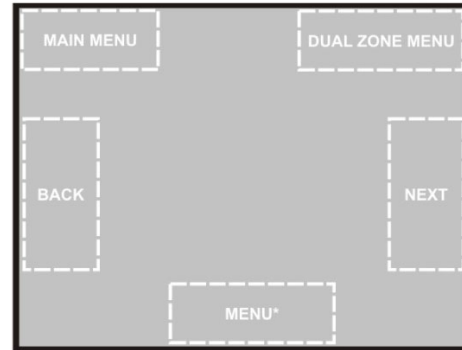

Illustr. 10.3



Illustr. 10.4



# 11 Display

## 11.1 Display when the monitor is closed

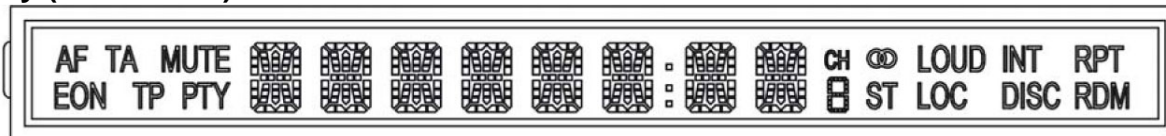
Display (entire view) when the monitor is closed



The display of the device can show the following messages during the operation:

<b>MUTE</b>	The loudspeakers have been muted	<b>LOUD</b>	The LOUDNESS function has been activated
<b>HITRADIO</b>	(Example): RDS program name	<b>100.60</b>	Frequency in the FM range
<b>PTY</b>	A broadcast program with program type information is being received	<b>TP</b>	A broadcast program with traffic information is being received
<b>EON</b>	EON (Enhanced Other Networks) data are being received		Preset location of the selected station on the station buttons
<b>LOC</b>	The selection of local radio stations has been activated.		An FM stereo program is being received
<b>DISC</b>	CD/DVD has been inserted	<b>INT</b>	Beginnings of tracks are being played (intro)
<b>RDM</b>	Tracks are played back in random sequence (Random)	<b>TA</b>	Readiness for traffic alerts has been activated
<b>AF</b>	Alternative frequency has been activated	<b>RPT</b>	A CD track is being repeated (Repeat)
<b>STOP</b>	The playback has finished.	<b>00:28</b>	Duration of the current track

## 11.2 Display when the monitor is open

To open the monitor, please press button ⑰. To call up the monitor menu, please press the “OSD button” ⑳. When the monitor is open, the following setting options and functions are available:

### Setting of the playback source

Menu entry	Function	
RADIO MODE	Switches to the radio mode and reproduces the most recently played station.	
DVD MODE	Switches to the DVD mode and starts the playback of the inserted CD/DVD data carrier.	
SD CARD	Switches to the data carrier and begins the playback of the files it contains.	
AUX IN	Switches to the AUX IN input and displays the accompanying video signal on the screen.	
CAMERA	Switches to a connected camera and shows the image recorded by the camera.	
DUAL ZONE	Switches to the DUAL ZONE submenu.	
SETUP	Switches to the menu for the device settings.	

The functions “NAVIGATION” and “TV MODE” are on a grey surface and not available.

## Second playback level (dual zone)

The device has a second playback level (dual zone). This makes it possible to address a second playback medium. For example: listening to the radio on the front seats and watching a DVD on the back seats. Several combination options are available here.

### Setting up the second playback level

Menu entry	Function
DVD MODE	Starts the playback of the inserted CD/DVD data carrier.
SD CARD	Starts the playback of the inserted SD/MMC data carrier.
AUX IN	Switches to the video and audio input of the device. This makes it possible to integrate external video and audio sources.
DUAL OFF	Ends the second playback level.



The TV function is on a grey surface and not available.

## Setup menu

Menu entry	Function
AUDIO	Switches to the submenu for audio settings
VIDEO	Switches to the submenu for video settings
SYSTEM	Switches to the submenu for system settings
RDS	Switches to the submenu for RDS settings
CALIBRATION	Switches to the submenu for the orientation of the touch screen



The TV function is on a grey surface and not available.

## Audio menu

Menu entry	Function
BASS	Setting the bass levels from -7 to +7
TREBLE	Setting the treble levels from -7 to +7
BALANCE	Setting the left and right speaker ratio from L-8 to R-8.
FADER	Setting the playback ratio between the front and rear from F-8 to R-8.
SUBWOOFER	Turning the subwoofer on and off
S.VOLUME	Setting the initial volume level. The maximum volume level of the device is at 45. The initial volume level can be set between 0 - 45. The initial volume level is a function that protects from hearing damage. To protect your health, leave the initial volume at a low level and, if necessary, adjust the playback volume according to the external conditions.



## Video menu

Menu entry	Function	
BRIGHT	Setting the screen brightness from 0 to 40	
CONTRAST	Setting the screen contrast levels from 0 to 40	
COLOR	Setting the screen colour values from 0 to 40	
SHARP	Setting the screen playback sharpness from 0 to 6	
SCREEN	Setting the side ratio during the playback. The side ratios 16:9 and 4:3 are available.	

## RDS Menu

Menu entry	Function
AF	Turning the alternative frequency function on and off.
REGION	Turning the function for regional programs on and off.
TP	Turning the traffic alert function on and off.
EON	Turning the EON function on and off.
PTY	Turning the PTY function on and off.
TA VOL	Setting the volume of the traffic alerts. The volume can be selected between 0 and 45.



Further information about the individual functions can be found in section 14.



## System menu

Menu entry	Function	
BEEP	Turning the button sounds on and off.	
TILT	The TILT function makes it possible to set the position of the monitor. With AUTO, the monitor is retracted when the device is turned off. With MANUAL, the monitor remains open when the device is turned off. But it can be closed and opened again at any time by pressing the “OPEN” button.	
TILT RANGE	This function lets you adjust the tilt of the monitor according to your personal preferences. Different setting options are available.	
IN/OUT FIX	The IN/OUT FIX function allows you to vary the distance of the monitor towards the front or the rear so that it can be adjusted according to your personal preferences. NONE lets you freely choose the position. With FIXED, you lock the monitor into a particular position.	
TIME SET	A function to set the time of day.	

## 12 Activation

### 12.1 Insertion of the operating unit

In order to activate the car radio, you first have to insert the operating unit.

First slide the operating unit in a slightly tilted position from the left into the right holder  and

then press it against the casing until it audibly snaps into place. Now you can turn on the device. If the device was turned on when the operating unit was removed, it will automatically turn on with the last setting (radio, CD, SD/MMC, AUX IN) as soon as the operating unit is inserted again.

## 12.2 Removal of the operating unit (theft protection)

In order to remove the operating unit and thus protect your car radio from theft, turn off the device with the on/off button ⑧. Now press the REL button ①. The operating unit then releases from the device and you can detach it towards the front and left. Place the operating unit into the provided case and take it with you when you leave the car.

# 13 Basic functions

## 13.1 Turning on/off

To turn on the device, briefly press the on/off button ⑧ on the operating unit. To turn the device off, press the same button again. The device will then turn off.

### Note:

If the device is activated after the ignition has been started, it will automatically turn on and off with the ignition during subsequent operation. A prerequisite for this is that the contact A7 is connected to terminal # 15 of the vehicle (see illustr. 8.3 and illustr. 8.4).

### Caution!

When the radio is turned on, an automatic antenna that may be installed on the vehicle will also be extended. Before driving into a car wash, you should therefore always turn off the device in order to avoid damages to the antenna as well as the vehicle.

## 13.2 Changing the volume

The volume of the device can be changed with the round control dial ②. The current volume of the device will be indicated on the display in the process. The volume scale ranges from 0 – 45.

### Note:

When the car radio is turned off, the volume is only stored if it falls below the level of the “S.VOLUME” setting. Any volume levels exceeding this are reduced to protect hearing. The volume for the reactivation can be set in the system menu under the “S.VOLUME” function.

### Note:

- Don't use the car radio at an excessive volume. Otherwise there is the risk that you will permanently damage your hearing.
- Please consider that while using the device you should still be in the position of perceiving your surroundings (warning signals, sirens, etc.).
- Please only perform lengthy changes of the device settings while the vehicle is parked. Otherwise your concentration might be affected by the changes.

## 13.3 Muting the speakers

To mute the connected speakers, briefly press the “MUTE” button ⑫. “MUTE” will appear on the display. To return to the original volume, press the “MUTE” button ⑫ again briefly or turn the volume control dial. The message “MUTE” will turn off and the volume will be at the same level as before it was muted.

### Note:

The MUTE setting also affects the LINE outputs and disrupts these until the function is deactivated again.

## 14 Radio (tuner) mode

### 14.1 Selection of the radio station

Turn on the SilverCrest CDV-710 CD/DVD car radio with the on/off button ⑧. If the device was turned off while it was in RADIO mode, the last selected station will be heard. If the device is set to an operation with one of the different data carriers, please press the “MODE” button ④ until you get to the radio function.



Radio display with open monitor



Radio display with open monitor with activated second playback level (dual zone)

### 14.2 Selection of the wavelength range



**FM (UKW) range:** To select the FM range, briefly press the “BAND” button ⑯ repeatedly until the desired range “F1”, “F2”, or “F3” (with a closed monitor) or “FM 1”, “FM 2”, or “FM 3” (with an open monitor) appear on the display along with the current frequency.

**MW range:** To select the MW range, briefly press the “BAND” button ⑯ repeatedly until “M1” or “M2” (with a closed monitor) or “MW 1” or “MW 2” (with an open monitor) appear on the display along with the current frequency.

**Note:**



- After selecting a range, the station last selected in this range will be heard.
- When the monitor is open, the “BAND” button  on the screen is also available for the selection of the wavelength range.





### 14.3 Searching for a radio station with the scanner

To set the stations, select the desired wave band with the “BAND” button  (section 13.2). In order to begin searching in the desired direction, briefly press the five-way multifunction button . Press the button towards the left to diminish the search frequency or to the right to increase the search frequency. The scanner will stop at the next available station.

When the monitor is open, the buttons  and  on the on-screen keyboard are also available to change the frequency.

### 14.4 Manual search for a radio station

In order to select a station manually, press the five-way multifunction button  for about three seconds towards the right or left. The display will indicate “MANUAL”. Now press the five-way multifunction button  towards the right to increase the frequency, or to the left to diminish the frequency until the desired frequency is indicated on the display. The frequency will change in 50kHz increments in the FM range. If there is no entry for about seven seconds, the device will switch back to automatic station search. The display will indicate “AUTO”.

When the monitor is open, the buttons  and  on the on-screen keyboard are also available to change the frequency. Here you also have the option to search manually, by pressing one of the buttons  and  for three seconds. MANUAL will be indicated in the corresponding field. If there is no entry for about seven seconds, the device will switch back to automatic station search. The corresponding field on the screen will indicate “AUTO” again.

## 14.5 Storing a station with the station buttons

With the station buttons “1”, “2”, “3”, “4”, “5”, and “6” you can preset six programming spaces each on each level of the wave band (e.g. “FM 1“, “FM 2“, or “FM 3”).

To store the station, select the corresponding station with the station search or manually. Press one of the buttons “1”, “2”, “3”, “4”, “5” or “6” until the radio sound is briefly muted in order to store the station. Now the station is stored at the station button you selected.

When the monitor is open, please keep your finger on the corresponding station field until the playback is briefly interrupted. Now the station is stored at the corresponding position.

## 14.6 Storing stations with automatic station search

The automatic station search scans for the strongest available stations and stores these under the station selection buttons “1” - “6”.

In order to start the search, press the “P.SCAN” button  and keep it pressed for more than two seconds. Now the scanner allocates all station positions at the current level of the selected wave band as long as enough stations with sufficient reception quality are available. After the scanning has ended, the stored stations are automatically matched up with their station names and the station stored at the station position “1” can be heard. Now the device will briefly play all stations in sequence and then stop at the station under the station button “1”.

When the monitor is open, the PSCN field is available to you for this function.

## 14.7 Calling up stored stations

In order to access the stored stations, select the desired wave range with the “BAND” button , e.g. “FM 1”. Press one of the six station buttons and you will hear the station stored there. The corresponding applies when the monitor is open.

## 14.8 Checking stored stations

For this function, the stations stored under the station buttons of a particular wave length are scanned for about five seconds.

In order to begin checking, briefly press the “P.SCAN” button . The station positions “1” - “6” will begin flashing on the display in sequence and the corresponding stations will be scanned. When the monitor is open, the currently scanned memory position has a lighted background and PRESET will be indicated on the display. The PSCN field will be available to you here as well.

To remain at the currently scanned station, press the “P.SCAN” button  or the PSCN field again. Then the setting will remain at the last scanned station. If no entry is made by the end of the complete search, the device will play the first station on the corresponding level (e.g. F1 or FM 1).

## 14.9 LOC function

The “LOCAL” function is relevant for the station search. Here you can select whether only local, strong stations (“ON”) or also weaker, more distant stations (“OFF”) are searched for.

The “LOC” function prevents a corresponding switch to a stronger station as long as it isn’t broadcasting the same program as the one currently being listened to.

You can activate the function by briefly pressing the screen button “LOC” once. Then the button switches colours from grey to white. If the button sounds are turned on, a brief signal tone will follow. This function can be turned off again by pressing the screen button “LOC” once more. Then the colour changes from white to grey again and this may be followed by a signal tone.

To find out how to set the function when the monitor is closed, please refer to section 19 below.

### Note:

This setting only affects the radio mode and can only be carried out while the radio mode is active.

## 14.10 STMO function

The “STMO” function enables you to switch back and forth between mono and stereo playback. This is especially useful when the stereo signal of the selected radio station doesn’t carry an ideal strength. In order to activate the “STMO” function, please press the screen button “STMO” once briefly. Then the colour changes from white to grey again and the radio signal is briefly interrupted.

In order to deactivate the “STMO” function again, please press the screen button “STMO” briefly once more. Then the colour of the button changes from white to grey again and the radio signal is briefly interrupted.

## 14.11 RDS

RDS is an information system whose signals are additionally broadcast by most FM stations. With RDS programs, the name of the program appears as an abbreviation on the display. Further information, such as frequency, time and program type (PTY) can be faded in. An RDS program will be broadcast by several senders on different frequencies (alternative frequencies). If an RDS program has been selected, the device automatically switches to the alternative frequency that can be received most clearly, as long as that is available and the AF function (section 13.6) has been turned on.

You can read the RDS information when the monitor is open. The time, RDS station name and frequency will appear on the display.

## 14.12 Traffic announcements (“TA“, traffic program, ”TP“)

To activate the traffic announcement program, please press the “TP” button ③ briefly. The message “TA” will appear on the display and the readiness for announcements is turned on.

To deactivate the traffic announcements, press the “TP” button ③ again. The message “TA” disappears and the readiness for announcements has been switched off.



When the monitor is open, the display will jump to the RDS submenu and switch the function on or off. If there is no entry for approx. ten seconds, the device returns to the radio display and store the changes that were made.

**Note:**

- If the selected station is not a traffic broadcast station, the device automatically starts to scan for the next traffic broadcast station.
- If “TP” is turned on, the CD/DVD, SD-MMC, USB and AUX IN operation is interrupted for a traffic announcement and will be continued afterwards. For the duration of the traffic alert, “TP” will appear on the display. During AUX IN operation, the current track will not stop but continue playing. To stop the device connected via AUX IN, please consult the manual of the respective manufacturer of the device.
- If you only want to hear traffic announcements, turn on the announcement function with the “TP” button and turn the volume to “VOL 0” with the volume control dial or use the MUTE function. The device will automatically regulate a volume increase for traffic announcements.
- The TA volume can be individually adjusted under the volume item “TA VOL”.

### 14.13 Alternative frequencies (“AF“)

To activate the “AF” function, briefly press the “AF/REG” button . The message “AF” appears and the function is turned on.

To turn off the “AF” function, briefly press the “AF/REG” button . The message “AF” disappears and the function is deactivated.

**Note:**

- The “AF” function is only displayed for broadcast stations that broadcast an “AF” signal. The “AF” message flashes when the “AF” function is activated but no “AF” signal is available.
- If an RDS (radio data system) station is being received that is broadcast by several broadcast stations with different frequencies, the device automatically switches to the frequency that can be received most clearly. The “AF” function is activated when the device is shipped.
- In an area with bad reception, attempts to change between alternative frequencies can be heard as disruptive pauses. In such an event, the “AF” function can be turned off.

**Note:****Radio reception conditions**

In the FM wave band, there can be changes in the reception conditions during the drive. Mountains, buildings or bridges can diminish reception. This applies especially if the distance to the station is large.

**Enhanced Other Networks (EON)**

The “EON” function is an additional RDS service. If the current program doesn’t offer any traffic announcements, EON automatically switches to the traffic announcements on another program. After the end of the announcement, the device switches back to the previously heard station. The readiness for traffic announcements “TA” has to be activated for this.

To turn the EON function on or off, please switch to the RDS menu.

## 14.14 Regional programs (“REG“)

Some radio stations divide their programs into regional programs with different content at specific times. If the reception is getting worse, the “REG” function prevents the car radio from changing to alternative frequencies that have different program contents.

To turn the “REG” function on or off, please keep the “AF/REG” button  pressed until "REG-ON" or "REG-OFF" appears in the display.

## 15 CD/DVD mode



The SilverCrest CDV-710 CD/DVD car radio supports the formats DVD, DVD-R, DVD-RW, DVD+R, DVD+RW, DVD-R DL, DVD+R DL, CD, CD-R, CD-RW, VCD, SVCD, MP3, WMA, OGG Vorbis and JPG image CD. The minimum bitrate of WMA and MP3 files are at 32 kbps and for OGG files at 45 kbps. The maximum bitrate of WMA files is at 192 kbps, MP3 files at 320 kbps, and OGG files at 500 kbps.

### Note:

- Conditional on the quality differences of the media as well the characteristics of the recording, it can happen that some individually recorded CDs and DVDs are incapable of being read. Such events do not constitute a malfunction of the device.
- Audio CDs (CD-R and CD-RW) that are recorded individually have to be finalized at the end of the burning process.
- Note that the file names of the audio tracks have to correspond to the ISO-9660 standard. During the playback of MP3 CDs, individual tracks can be skipped or not played back correctly. This can be due to the respective disc configuration, the decoder software, or the hardware that was used for the recording.

- Copy-protected CDs do not correspond to the specifications of audio CDs (CD-DA), don't carry the respective logo, and can therefore cause playback errors.
- If a selected function is unavailable, a hand symbol  will appear in the upper left of the display.

## 15.1 Selecting a CD/DVD as the program source

To play a CD/DVD, turn on the device with the on/off button . If the device was turned off during CD/DVD operation, the playback begins at the track heard before turning off the device. If the device is set to another program source, press the "MODE" button  until "DVD" appears in the display. The display will indicate the message "LOADING".

When the monitor is open, the screen menu is also available for the selection of the program source.

### Note:

The program source "DVD" can only be selected through the "MODE" button  if there is a CD or DVD in the insertion slot.

For technical reasons, only "DVD" will appear on the display even if a CD is selected or played back. However, this has no effect at all on the playback or the quality.

## 15.2 Insert / remove CD

Before inserting a CD/DVD, make sure that no data carrier has already been inserted by pressing the "EJ" button .

To insert the CD/DVD, slide it into the insertion slot  with the printed side up. It will automatically be drawn inside.

The message "LOADING" will be indicated on the display. Then the message "01" will appear, followed by the time display of the track, which thus shows that the first track on the data carrier

is now being played back.

To eject the CD/DVD, press the “EJ” button  again and remove the ejected data carrier. When the monitor is open, the screen menu is also available to you for the ejection of the data carrier.



#### **Caution:**

- Only customary CD formats may be inserted into the CD insertion slot (Ø 12cm).
- Make sure that no foreign objects enter the CD slot.

#### **Note:**



Never use force when inserting the CD; this could damage the device as well as the CD. Never use force to try to prevent the device from pulling in a CD. If necessary, eject the CD again. If an ejected data carrier isn't removed within approx. ten seconds, it will be drawn back into the slot to prevent damage to the device.

### **15.3 Playback / pause / stop**

To pause the playback, briefly press the “Pause” button . “PAUSE” will be indicated on the display. To continue the playback, press the “PAUSE”  button again. To end the playback, briefly press the “Stop” button . “STOP” will be indicated on the display.

When the monitor is open, the screen menu is also available to you for these functions.

### **15.4 Selecting or repeating tracks**

By briefly pressing the  button, the playback jumps to the next track. If you press the  button, the playback returns to the beginning of the current track. If the  button is pressed twice, the playback jumps back to the previous track.

You can briefly press both the  and  buttons until the number of the desired track appears on

the display.

When the monitor is open, the screen menu is also available to you for these functions.

### 15.5 Fast forward and rewind

To fast forward, briefly press the **⏩** button once. Then the playback speed is increased to 2x. If the **⏩** button is pressed once more, the speed is doubled again. This can be continued up to the maximum advancing speed of 32x. You can stop this process by briefly pressing the **⏪** button once or pressing the **⏩** button one more time after the advancing speed of 32x has been reached. For a quick rewind, use the **⏪** button in a corresponding manner. To control the process, the increasing or decreasing minute and second amount is indicated on the display.

When the monitor is open, the screen menu is also available to you for these functions.

### 15.6 Repeating tracks (Repeat)

To repeat a track, keep the **⏮** button pressed until "R-ONE" appears on the display. The abbreviation "RPT" is shown and the current track is repeated. To repeat the entire folder or CD, press the **⏮** button again until "R-ALL" appears on the display. When the monitor is open, the messages "SPUR" will appear for "R-ONE" and "ALL" for "R-ALL".

To end the function, press the **⏮** button again until "R-OFF" appears on the display. The abbreviation "RPT" will be turned off and the playback of the tracks will continue normally.

### 15.7 Intro

To briefly scan the tracks on an audio CD, press the **⏩** button during the playback until "INT" appears on the display. Then all tracks will be scanned for approx. ten seconds. When the monitor is open, the message "INT" will appear.

To end the function, press the **⏩** button again until the "INT" message is turned off on the display. The playback continues at the point where the last intro was interrupted.

## 15.8 Playing tracks in random sequence (Random)

For random playback, press the ⑪ button during the playback until the abbreviation “RDM“ appears on the display. The device begins to play a randomly selected track. If the RDM button is pressed during the playback of a track, this track will be played again from the beginning. All other tracks will also be played back in random sequence. When the monitor is open, the message “RANDOM” will appear.

To end the random function, press the ⑪ button again until the abbreviation “RDM“ is turned off. The tracks will now be played back in their regular sequence.

### Note:

If the first track of a multi-session CD contains audio data, only the audio data are played back, even if other data formats are recorded.

## 16 SD/MMC operation

### 16.1 Inserting / removing SD/MMC

To insert an SD/MMC card, please press the ① button on the device. Now the operating unit can be removed. Now you can insert a data carrier into the SD/MMC card slot ③. Please insert your SD/MMC card into the card slot ③ with the contacts towards the top and front until it audibly snaps into position. SD/MMC cards with a storage capacity of up to 2 GB are supported. To remove an SD/MMC card, again press the card to be removed lightly into the device until it snaps out. Afterwards you can remove the card from the slot.

After removing the card, the device automatically switches to CD/DVD as a playback source. If a data carrier has been inserted, it will be played back. If no data carrier is inserted, the device

will remain in the STOP mode of the CD/DVD playback.

Never use force when inserting and removing an SD/MMC card; this could damage the device as well as the card. Also avoid direct skin contact with the contacts on the card to prevent contact problems.

**Note:**

Please consider that you only have approx. 20 seconds to insert an SD/MMC memory card into the insertion slot  or remove it again. Otherwise the device will assume that the operating unit has been removed for theft protection and will turn itself off. If that is the case, just insert the operating unit again. Then the device will automatically turn on again.

## 16.2 Selecting SD/MMC as a program source

To play back audio tracks from an SD/MMC memory card, press the "MODE" button  to select "SD/MMC" as the data source.

Then the device will read the music tracks that can be reproduced from the memory card and begins to play back the first track.

**Note:**

The program source "SD/MMC" can only be selected through the "MODE" button  if there is an SD/MMC card in the card reader.



## 17 Playing back MP3/WMA/OGG files

In addition to audio CDs, the device can also play back music files in the MP3, WMA and OGG Vorbis formats. Insert a corresponding data carrier into the device and select this as the playback source.

To get to the desired folder or the desired track, please use the five-way multifunction button  to navigate. With this button you can navigate upward and downward. If you press the button to the right, you will reach the contents of the selected folder or additional information about the currently selected title. With images, a thumbnail preview will appear. If you press the button to the left, you will return to the higher level folder. Press the button normally to play back the selected title.

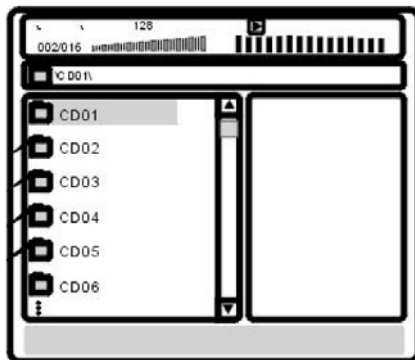

File overview

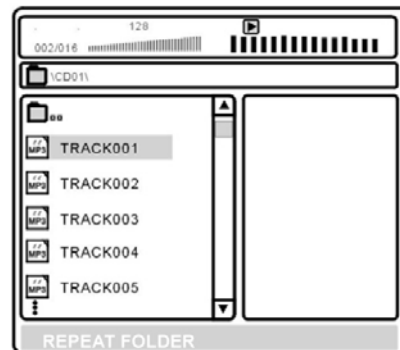

Track overview  
(here with activated repeat function)

If the files stored on the data carrier have been supplied with ID3 tags or comparable tag information, these will be indicated in the right half of the window during the playback.

## 18 Displaying images

This function allows you to display images on the screen. You can use this function for CD/DVD data carriers as well as for a SD/MMC memory card. The navigation of this function generally functions just as during the playback of MP3, WMA and OGG Vorbis files.

### 18.1 Slide show

To display the images in a slide show, change to the corresponding data carrier by pressing the "MODE" button (4). To get to the desired image, please use the five-way multifunction button (15) to navigate. With this button you can navigate upward and downward. With images, a thumbnail preview will appear. If you press the button to the left, you will return to the higher level folder. Press the button regularly to display the image at the full screen size. Now the slide show is started.

### 18.2 Rotating an image

During the slide show, you have the option of rotating the current image to the right or left by pressing the five-way multifunction button (15).

### 18.3 Zoom

The zoom function gives you the option of having the images and films displayed in an enlarged or reduced format.

To activate the zoom function, press the ZOOM button on the remote control for at least three seconds. The message "ZOOM 100%" will appear. Now the buttons ◀ and ▶ on the remote control as well as on the device will allow you to set the zoom value. The button ◀ decreases - the button ▶ increases the zoom value. The following levels are available: 50%, 75%, 100%, 125%, 150% and 200%. If the zoom level is larger than 100%, you have the option of moving

the image by means of the arrow buttons on the remote control as well as the five-way multifunction button ⑮.

To end the zoom function again, press the ZOOM button again for approx. three seconds until the function turns off and the next image is displayed.

## 18.4 Thumbnail view

With the thumbnail view, you have the option of having the images on the data carrier displayed in a set of nine small images for each page. To get to this overview, please press the stop button ■ during the slide show. The arrow buttons of the remote control or the five-way multifunction button ⑮ now give you the option of selecting the individual images or the navigation. By pressing the ENTER button you will confirm your selection.

## 19 AUX IN

The AUX IN (brown connection cable ③ from illustr. 8.3) is a connection with which you can connect external audio devices through their headphone or AUX output with this device. The audio tracks played back on these devices are then put out through the car speakers. This is how you can e.g. play back audio files that you have saved on your cell phone, minidisk, iPod® or tape recorder.

To connect external audio devices with the CD/DVD car radio CDV-710, you will need a cable with an RCA jack (right + left) on a 3.5 mm jack plug, which is not included in the scope of delivery. First connect this cable to the device - and then the headphone connection or AUX output of your playback device. Now you can start the playback. Set the volume of the playback device to a medium level and subsequently regulate the volume with your SilverCrest CDV-710. If the playback source of the SilverCrest CDV-710 has not been set to AUX yet, please press the "MODE" button ④ until AUX appears on the display.

## 20 Menu settings level 1

By briefly pressing the volume control dial ② once or several times, the functions of menu level 1, volume control, bass setting, treble setting, and the speaker balance between the left and right as well as front and rear speaker groups can be selected and set.

### 20.1 Changing the bass settings (BASS)

Pressing the control dial ② twice will result in reaching the bass settings. The message “BAS” will appear on the display together with the current level (e.g. B. “+2”). To change the bass bandwidth, turn the control dial ② clockwise or counter-clockwise. The bandwidth can be set in a range between “-7” and “+7”. It can be changed in increments of one.

The setting is saved either when the desired value is confirmed by pressing the control dial ② or through automatic memory (don't change anything on the device for approx. five seconds). If you confirm the selection by pressing the control dial ②, you will reach the next possible setting. If you use the automatic memory, the device will return to the standard display.

### 20.2 Changing the treble settings (TREBLE)

After pressing the control dial ② twice, the treble setting (TREBLE) can be reached. The message “TRE” will appear on the display together with the current level (e.g. “0”). To change the bandwidth of the treble, turn the control dial clockwise or counter-clockwise. The bandwidth can be set in a range between “-7” and “+7”. It can be changed in increments of one.

The setting is saved either when the desired value is confirmed by pressing the control dial ② or through automatic storage (don't change anything on the device for approx. five seconds). If you confirm the selection by pressing the control dial ②, you will reach the next possible setting. If you use the automatic memory, the device will return to the standard display.

### 20.3 Changing the volume ratio (BALANCE)

After pressing the control dial ② three times, the settings for the ratio between the speakers connected on the right and left can be reached (BALANCE).

The message “BAL” appears on the display along with the settings for the volume ratio between the right and left speaker group (e.g. “BAL R2”). To change the ratio between the speakers, turn the control dial ② clockwise or counter-clockwise. Depending on the direction in which the control dial is turned, an “R” (right speaker group) or an “L” (left speaker group) will appear on the display, together with a digit (e.g. “R2” or “L4”). These provide information about the direction in which the volume ratio is changed and about the amount of the change. The ratio between the right and left speaker group can be set in a range between “8R” and “8L”.

The volume ratio between the speakers changes according to the setting and the volume will increase on one side according to this setting and decrease on the other side.

#### Note:

- If the ratio is set to “R-L”, the volume on both speaker groups is the same.
- If the control dial is set to the maximum position of “8” on one of the two sides, the speaker group on the opposite side will be muted. To change this, turn the control dial ② again.

The setting is saved either when the desired value is confirmed by pressing the control dial ② or through automatic storage (don't change anything on the device for approx. five seconds). If you confirm the selection by pressing the control dial ②, you will reach the next possible setting. If you use the automatic memory, the device will return to the standard display.

## 20.4 Changing the volume distribution (FADER)

After pressing the control dial ② four times, the settings for the speaker distribution between the front and rear speaker group (FADER) will be reached.

The message “FAD” will appear on the display along with the set volume ratio between the front and rear speaker group (e.g. “FAD 2F”). To change the ratio between the speaker groups, turn the control dial ② clockwise or counter-clockwise. Depending on the direction in which the control dial is turned, an “R” or an “F” will appear on the display, together with a digit (e.g. “F2” or “R3”). These provide information about the direction in which the volume ratio is changed and about the amount of the change. The ratio between the right and left speaker group can be set in a range between “F8” and “R8”.

The volume ratio between the speakers changes according to the setting. The volume of one speaker group increases, the other decreases.

### Note:

- If the ratio is set to “R-F”, the volume on both speaker groups is the same.
- If the control dial for one of the two speaker groups is turned to the maximum setting “8”, the other speaker group is muted. To change this, turn the control dial ② again.

The setting is saved either when the desired value is confirmed by pressing the control dial ② or through automatic memory (don't change anything on the device for approx. five seconds). If you confirm the selection by pressing the control dial ②, you will return to the standard display. If you use the automatic memory, the device will return to the standard display.

### Note:

If you press the control dial ② again after you reach the last settings option (here FADER), you will return to the standard display. If no changes are made for five seconds, the device will automatically return to the initial display. In DVD mode (with an open monitor), the settings option FADER is also followed by the functions BRIGHT, CONTRAST, COLOR and SHARP.

## 21 Menu level 2

You can reach menu level 2 by pressing the control dial ② for approx. two seconds. The individual menu items can be reached by repeatedly pressing the control dial.

At menu level 2, the functions “LOC” (distance setting for station search), “LOUD” (sound setting), “ST-MO” (switching between stereo and mono playback), “CT” (set time of day), “TAVOL” (standard volume for traffic announcements), “EON” (automatic station switch for traffic announcements), “D/Z” (setting of the second playback level - DUAL ZONE) can be set.

When the monitor is open, the functions referred to above are available to you under the following alternate terms: ST-MO = STMO, CT = TIME, TAVOL = TA VOL

### 21.1 LOC function to set the station search

The “LOCAL” function is relevant for the station search. Here it can be selected whether only local, strong stations (“ON”) or also weaker, more distant stations (“OFF”) are searched for.

The “LOC” function prevents a corresponding switching to a stronger station as long as it isn’t broadcasting the same program as the one currently being listened to.

To activate the “LOC” function, press the control dial ② until menu level 2 is reached. The “LOC” function will appear. Now you have the option of activating (“LOC ON”) or deactivating (“LOC OFF”) the function by turning the dial.

The setting is saved either when the desired value is confirmed by pressing the control dial ② or through automatic memory (don’t change anything on the device for approx. five seconds). If you confirm the selection by pressing the control dial ②, you will reach the next possible setting. If you use the automatic memory, the device will return to the standard display.

#### Note:

This setting only affects the radio mode and can only be carried out while the radio mode is active.

## 21.2 LOUD function for the tone setting – loudness

The “LOUD” function makes it possible to emphasize low and high frequencies through the push of a button in order to increase sound perception in an adjustment to the respective volume.

To activate the “LOUD” function, press the control dial ② until menu level 2 is reached. The “LOC” function will appear. Press the control dial ② repeatedly until you get to the menu item “LOUD”. There you will have the option of activating (“LOUD ON”) or deactivating (“LOUD OFF”) the function by turning the dial.

The setting is saved either when the desired value is confirmed by pressing the control dial ② or through automatic memory (don't change anything on the device for approx. five seconds). If you confirm the selection by pressing the control dial ②, you will reach the next possible setting. If you use the automatic memory, the device will return to the standard display.

### Note:

When the “LOUD” function (“LOUD ON”) is activated, the message “LOUD” appears on the display. This is turned off after deactivation.

## 21.3 ST – MO function to switch between stereo and mono playback

This menu item gives you the option of selecting between stereo and mono playback.

To reach the menu, press the control dial ② until menu level 2 is reached. The “LOC” function will appear. Now briefly press the control dial ② repeatedly until you reach the menu item “ST-MO”. There you will have the option of selecting between “ON” and “OFF” by turning the dial. The selection “ON” will turn the mono playback on. “OFF” will turn the stereo playback back on again.



The setting is saved either when the desired value is confirmed by pressing the control dial ② or through automatic memory (don't change anything on the device for approx. five seconds). If you confirm the selection by pressing the control dial ②, you will reach the next possible setting. If you use the automatic memory, the device will return to the standard display.

**Note:**

This setting only affects the radio mode and can only be carried out while the radio mode is active.

## 21.4 CT function to set the time of day

To set or change the time settings, press the control dial ② until you get to menu level 2. The "LOC" function will appear. Press the control dial ② repeatedly until you get to the menu item "CT". There you have the option of setting the time of the device by turning the dial. Turning to the right changes the number of the hours, turning to the left, the minutes.

The setting is saved either when the desired value is confirmed by pressing the control dial ② or through automatic memory (don't change anything on the device for approx. five seconds). If you confirm the selection by pressing the control dial ②, you will reach the next possible setting. If you use the automatic memory, the device will return to the standard display.

**Note:**

If the device receives an RDS station with an RDS time signal, the clock will be automatically updated in particular intervals.

## 21.5 TAVOL function to set the volume for traffic announcements

The “TAVOL” function enables an adjustment of the volume of traffic announcements according to individual preferences.

To change the device’s volume for traffic announcements, press the control dial ② until menu level 2 is reached. The “LOC” function will appear. Press the control dial ② until you get to the menu item “TAVOL”. There you have the option of setting the device’s volume for traffic announcements by turning the dial. Turning to the right increases the volume for traffic announcements, turning to the left reduces the volume for traffic announcements. The volume for traffic announcements can be set between 0-45. Here 0 = no sound and 45 = maximum volume of the device.

The setting is saved either when the desired value is confirmed by pressing the control dial ② or through automatic memory (don’t change anything on the device for approx. five seconds). If you confirm the selection by pressing the control dial ②, you will reach the next possible setting. If you use the automatic memory, the device will return to the standard display.

### **Note:**

During a traffic announcement, it’s possible to adjust the volume to the current requirements at any time through the control dial ②.

## 21.6 EON for the automatic station switch for traffic announcements

The “EON” function is an additional RDS service. If the current program doesn’t offer any traffic announcements, EON automatically switches to the traffic announcements on another program. After the end of the announcement, the device switches back to the previously heard station. The readiness for traffic announcements “TA” has to be activated for this.

To activate the “EON” function, press the control dial ② until menu level 2 is reached. The “LOC” function will appear. Press the control dial ② until you get to the menu item “EON”. There you will have the option of activating (ON) or deactivating (OFF) the function by turning the dial. If the “EON” function is activated, “EON” will appear on the display.

The setting is saved either when the desired value is confirmed by pressing the control dial ② or through automatic memory (don’t change anything on the device for approx. five seconds). If you confirm the selection by pressing the control dial ②, you will reach the next possible setting. If you use the automatic memory, the device will return to the standard display.

## 21.7 D/Z for the settings of the second playback level (DUAL ZONE)

The device has a second playback level (dual zone). This makes it possible to address a second playback medium. For example: listening to the radio on the front seats and watching a DVD on the back seats (this requires a second monitor). Several combination options are available here.

To activate the function, press the control dial ② until menu level 2 is reached. The “LOC” function will appear. Press the control dial ② repeatedly until you get to the menu item “D/Z”. There you have the option of activating the function by turning the dial and setting the corresponding playback source. Which playback source is available to you depends on which storage media have been inserted or connected. Generally they are all available.





The setting is saved either when the desired value is confirmed by pressing the control dial ② or through automatic memory (don't change anything on the device for approx. five seconds). If you confirm the selection by pressing the control dial ②, you will return to the standard display. If you use the automatic memory, the device will also return to the standard display.

## 22 DVD device settings

For the settings of the DVD drive, a separate menu is available to you. This can only be reached when the CD/DVD mode is activated. The submenu “preferred settings” is only available when the media playback has been stopped. When the monitor is open, you can reach the DVD device settings through the SETUP button ⑳.

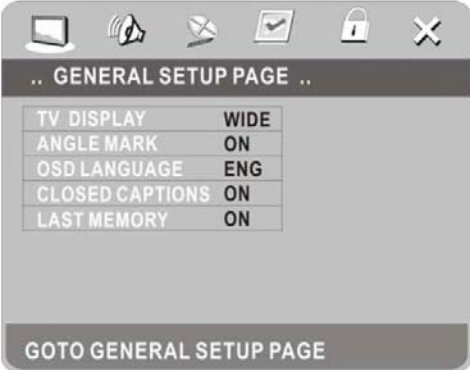
To get to the desired menu or the desired menu option, please use the five-way multifunction button ⑮ to navigate. With this button you can navigate upward and downward. If you press the button to the right, you will reach the settings options of the menu item. If you press the button to the left, you will return to the higher level item of the settings.

## 22.1 General settings

	 <p>4:3 Letterbox</p>	 <p>16:9</p>
	 <p>4:3 Pan scan</p>	 <p>16:9 Wide</p>
Menu entry	Function	
TV format	Here you can adjust the output format for the DVD playback according to your preferences.	
Viewing angle indicator	This function is indicated in the device menu but not supported by the device.	
OSD language	This menu item allows you to set the language of this menu.	
Subtitles	This function displays subtitles as long as those are available on the data carrier and the function is activated.	
Last memory	This pertains to a memory function that remembers the point where the playback was last stopped. If the function is activated, it's possible to continue the playback of a movie at the point at which it was last stopped.	

## 22.2 Audio settings



Menu entry	Function
Analog audio settings	<p>Here you can set the format in which the DVD sound should be played back.</p> <p>STEREO = analog stereo signal</p> <p>RIGHT / LEFT = Dolby Pro Logic stereo signal (2 channel sound)</p> <p>SURROUND = Virtual surround sound</p> <p>If STEREO has been switched on, "STR" will appear, for RIGHT / LEFT, "LTRT" will appear, and for SURROUND, "VSR".</p>
Digital audio settings	<p>This menu allows you to set the behaviour of the digital output (SPDIF).</p> <p>Digital output:</p> <p>Here you can set how the output should be performed. "SPDF ON" puts out the maximum available sound quality through the connection. If this option is set, the abbreviation "RAW" will be indicated on the display. "ONLY PCM" puts out a 2 channel stereo digital sound through the output. "SPDIF OFF" turns off the output through the digital connection.</p>

	LPCM (linear PCM) OUTPUT allows you to select either the audio CD standard (48K) or the DVD standard (96K).
Dolby digital settings	Through this menu you can adjust the behaviour of the Dolby function according to your own preferences and determine the desired type of output. Stereo = stereo sound, R-mono and L-mono each play back the sound only through the selected channel. The setting mix-mono only functions during the DVD playback with DTS 5.1. In addition, you have the option of setting the level of the linear compression. Different levels are available to you here (OFF, 1/8, 1/4, 3/8, 1/2, 5/8, 3/4, 7/8, FULL).
Equalizer settings	Through this function you can adjust the tone colour of the output sound according to your own preferences. Through the EQ type, you can select the preset sound settings. The menu item bass increase just allows you to increase the bass frequencies. With super bass, you have an additional option of increasing the bass output. The setting treble increase also allows you to increase the treble levels correspondingly.
3D Effect settings	Through this function you can adjust the sound effects of the output sound according to your own preferences. The echo mode setting enables you to select one of the preset reverberating effects.
HDCD	The HDCD function enables you to carry out certain settings if you are using such a data carrier. Because of the low market distribution of this type of data carrier, this function is turned off by default.

## 22.3 Video settings

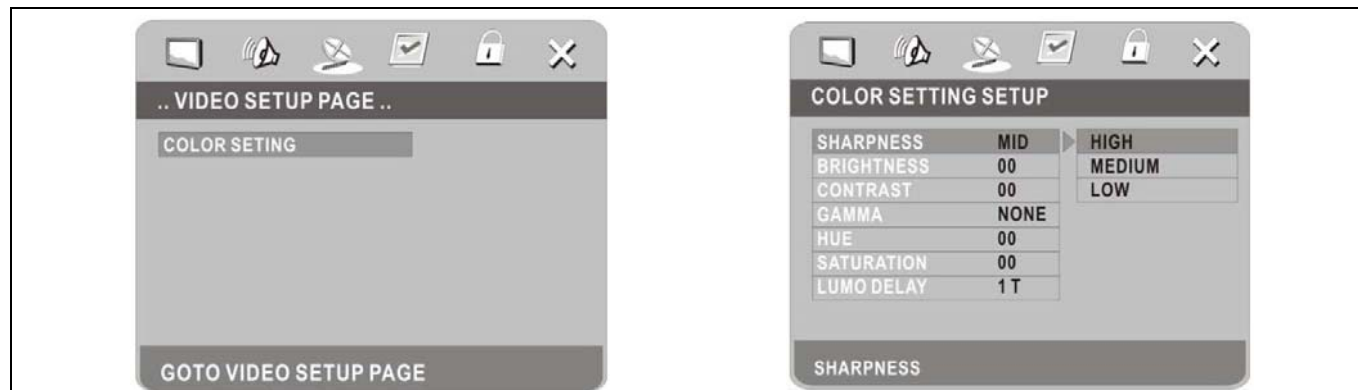

Menu entry	Function
Colour settings	This function enables you to adjust the colour settings of the DVD playback according to your preferences (possible levels are listed in brackets)
Sharpness	This serves to set the sharpness of the image (high / medium / low).
Brightness	This serves to set the brightness of the image (- 20 to + 20).
Contrast	This serves to set the contrast of the image (- 16 to + 16).
Gamma	This serves to set the gradation. The gradation is the exponent between the displayed brightness and the image or pixel values (high / medium / low / none).
Hue	This serves to set the hue (- 9 to + 9).
Saturation	This serves to set the colour saturation (- 9 to + 9).
Luma delay	This serves to set the luminance delay. A change in this setting is only required if the colour and brightness aren't coextensive ("0 T" and "1 T").



## 22.4 Preferred settings

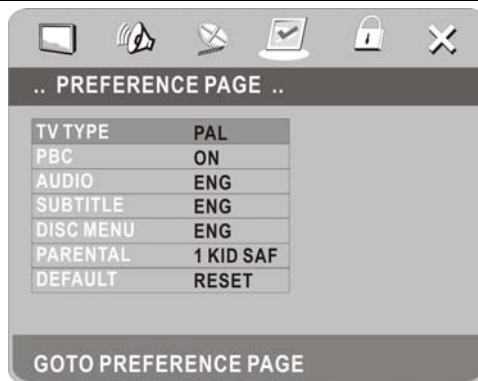

Menu entry	Function
TV format	This setting enables the selection of the appropriate TV standard. PAL is the customary standard in Europe. NTSC is the customary standard in the US and Japan. Only select the MULTI option if your TV can play back both formats. Here the output signal is automatically adjusted to the standard of the inserted DVD. If the “MULTI” setting is selected, “AUTO” will be displayed to the left of the selection menu.
Playback control	The playback control function serves to turn the playback control for VCD and SVCD data carriers on and off. This function is also abbreviated as “PBC”.
Audio language	This enables the selection of the desired dubbed language. If the language selected here is not available on the inserted data carrier, the first language that is found will be played back.

Subtitles	This enables the selection of the desired subtitles. If the subtitles selected here are not available on the inserted data carrier, the first subtitles that are found will be played back.	
Menu language	This enables the selection of the desired menu language. If the language selected here is not available on the inserted data carrier, the first language that is found will be played back.	
Age rating	<p>This serves to set the desired age rating.</p> <p>1 Child = not used  2 G = FSK 0  3 PG = not used  4 PG 13 = FSK 12  5 PGR = not used  6 R = not used  7 NC17 = FSK 16  8 18 or older = FSK 18</p>	After setting the age rating, you will be prompted to enter a password. The factory default password is set to <b>136900</b> . Enter this through the number buttons on the remote control. Now select "YES" or "NO" with the arrow buttons. Then confirm your selection with the "ENTER" button.
Factory settings	This function resets the DVD device settings to the factory default settings.	

## 22.5 Password settings

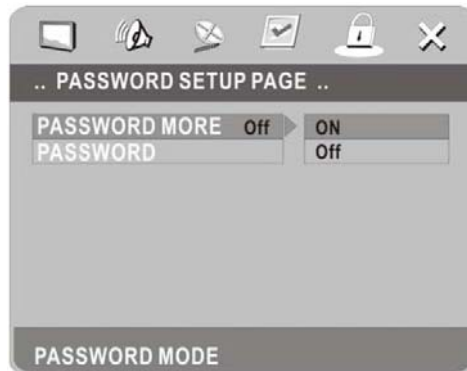



Menu entry	Function
Password protection	This function serves to protect the selected settings. The factory default password is <b>136900</b> .
Password	With this function you have the option of changing the factory default password.
Old password	Enter the old password here.
New password	Enter the new password here.
Confirm password	Confirm the new password here.

After you have confirmed the password, please press the ENTER button on the remote control. Now the new password is saved.



**Note:**

If you have forgotten your changed password, you can set a new one at any time by entering the factory default password **136900**.

**22.6 Exiting the settings**

To exit the settings menu again, please navigate to the last item in the bar on top. The menu item “exit menu” will appear. Press the five-way multifunction button  once to exit the menu. You can also exit the menu at any time by pressing the SETUP button .

**23 Factory default settings (“RESET“)**

By using the reset function, the device can be changed back to the factory default settings. To use the reset function, please press the button REL  on the device. Now the operating unit can be carefully detached towards the front and left. Now press the button  on the device with a thin, sharp object. The device will then be reset and turned off if required.

**Note:**

When the factory settings are restored, the clock and the stored radio stations will also be reset or erased.

## 24 Remote control

### 24.1 Remote control (normal)

The buttons of the remote control fulfil the same functions as the buttons with the same names on the device. Special functions are described in detail in the table below.

	Button	Function
	AUDIO	Switches the audio channel of the current DVD to another playback language (if available).
	SUBTITLE	Switches the subtitle language of the current DVD to another playback language (if available).
	A-B	Repeat function
	ZOOM	The zoom function gives you the option of having the film scenes and stills displayed in an enlarged or reduced format. To activate the zoom function, keep it pressed for approx. three seconds.

## 24.2 Remote control (Dual Zone)

The buttons of the remote control fulfil the same functions as the buttons with the same names on the device. Special functions are described in detail in the table below.

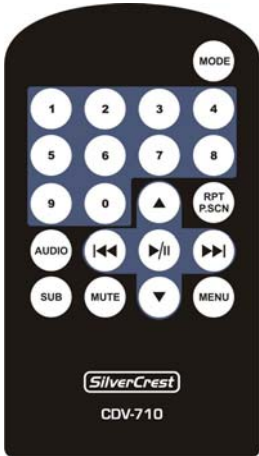
	Button	Function
 <p>The image shows a black SilverCrest remote control with a numeric keypad (0-9), a MODE button, an AUDIO button, a SUB button, a MENU button, and playback control buttons (play/pause, stop, previous, next). The remote has the SilverCrest logo and model number CDV-710 at the bottom.</p>	MODE	Switches the playback source.
	AUDIO	Switches the audio channel of the current DVD to another playback language (if available).
	SUB	Switches the subtitle language of the current DVD to another playback language (if available).
	MENU	Activates the screen menu of the DVD playback.

## 24.3 Changing the battery

### Remote control

To change the battery, the battery compartment can be pulled out towards the front.

Now replace the old battery with a new one of the same type (CR 2025). Please pay attention to the polarity ("+" pole" to the top) when you insert the battery. Please only touch the battery on the edge, since there might be contact problems otherwise.

Now slide the battery compartment with the new battery back into the case. Make sure that the battery compartment is positioned flush inside the case again after changing the battery.

### Remote control (DUAL ZONE)

To change the battery, please press the lock on the left side of the battery case slightly to the right. Now the battery compartment can be pulled out towards the front.

Now replace the old battery with a new one of the same type (CR 2025). Please pay attention to the polarity ("+" pole" to the top) when you insert the battery. Please only touch the battery on the edge, since there might be contact problems otherwise.

Now slide the battery compartment with the new battery back into the case. Make sure that the battery compartment snaps back into the case.

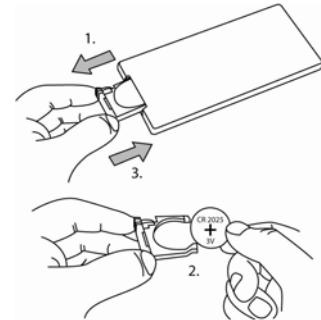

#### Note:

Please remove the safety disk on the battery compartment before first using the remote control. Otherwise the remote control won't operate properly.

## 24.4 Disposal of the battery

Please consider that you as an end consumer are obligated to return discarded batteries that are hazardous waste to a distributor or a redemption site intended for this purpose by a public waste management facility.

# 25 Product information

## 25.1 General information

### General

Operational voltage:	12 V
Fuse:	15 A
Grounding:	Negative pole on the vehicle body
Installation angle:	Vertical 0° to +30°, horizontal ±15°
Net weight:	2.5 kg
Composite video input:	1
Composite video input (camera):	1
Audio input (AUX):	1
Subwoofer output:	1
Maximum power consumption:	10 A
Installation size (W x H x D ):	178 x 50x (165+25) mm
Station memory:	30 (18 UKW / 12 MW)
Audio output (AUX):	2 (rear/front)
Optical SPDIF output:	1
Power output (RMS):	4 x 20 W
Maximum power output:	4 x 40 W



## 25.2 Technical specifications

### UKW RADIO

Frequency range:	87.5 – 108.0 MHz
Usable sensitivity (S/N):	10 dB $\mu$
Minimum reception level for station search:	20-30 dB $\mu$ V

Distortion:	0.5%
Stereo channel separation (1 KHz):	30 dB
Antenna impedance:	75 $\Omega$
Signal/noise ratio:	60 dB

### MW RADIO

Frequency range:	522 - 1620 kHz
Usable sensitivity (S/N 20 dB):	30 dB $\mu$
Distortion:	10 dB

### DVD PLAYER

Signal/noise ratio:	90 dB
Dynamic range:	90 dB
Distortion factor (line out):	0.1%
Frequency range ( $\pm$ 3 dB):	20 Hz – 20 KHz
Impedance:	4 $\Omega$

SD/MMC data carrier	max. 2 GB
---------------------	-----------

**AUX IN**

Distortion:	0.5%
Frequency range ( $\pm 3$ dB):	20 Hz – 20 KHz
Audio input level:	1 Vrms

**VIDEO**

Normal video input level:	1.0 $\pm$ 0.2V (CVBS)
Video input impedance:	75 $\Omega$
Video output impedance:	75 $\Omega$
Video output level:	1.0 $\pm$ 0.2 V (for normal video input level)

**TFT Monitor**

Video standard:	PAL/NTSC
Screen diameter:	7 inches
Visible screen area:	154.1 (W) x 87.0 (H)
Resolution:	440 (W) x 234 (H)
Brightness:	400 cd/m (centre measurement after 30 min.)
Contrast:	60 (minimum)
Reaction time:	Increase 30 ms, decrease 50 ms
Viewing angle:	65° from above, 40° from below
Backlight:	CCFL LCD lifespan: 100000 hours (at 25°)

**Environment**

Temperature (operation): -20° to +60° (fan installed for internal cooling)  
Storage temperature: -30° to +80°  
Humidity (operation): 45% to 80% RH

Humidity (storage): 30% to 90% RH

**Supported formats**

DVD, DVD-R, DVD-RW, DVD+R, DVD+RW, DVD-R DL, DVD+R DL, CD, CD-R, CDRW, VCD, SVCD, MP3, WMA, OGG Vorbis and JPG data carriers.  
SD/MMC data carriers max. 2 GB

**Remote controls**

Type Infrared  
Battery CR2025

## 26 Disposal

Please consider that your electronic entertainment device is subject to the European guideline 2002/96/EC for the reduction of electronic waste.



You are therefore not permitted to dispose of your device in your household waste.

You can receive information regarding the disposal of old devices at the municipal administration, the waste disposal administration and the store where you purchased this product.

You can drop off your device free of charge at communal collection points.

With the proper disposal of old devices you prevent environmental damage and don't damage your health.

Please consider that you as an end consumer are obligated to return your discarded batteries to a distributor or a redemption site intended for this purpose by a public waste management facility.

## 27 Troubleshooting

If an error occurs, please consider these instructions before you have the device repaired. If you are unable to solve a problem despite these instructions, please consult the hotline. Don't try repairing the device yourself under any circumstances. In that event the device would lose its warranty.

Problem	Cause	Solution
The frame can't be slid off the device towards the rear	The disassembly key was not inserted correctly.	Reinsert the key. Make sure that the protrusion on the disassembly key points away from the device during the insertion.
The device does not play back any music	The connection cables haven't been attached correctly.	Please check if all cables have been attached correctly.
	The "MUTE" or "PAUSE" button are pressed.	Press the "MUTE" or "PAUSE" button again.
The device can't be turned on	On / off button was pressed too briefly.	Keep the on / off button pressed longer.
	The operating unit isn't inserted correctly.	Reinsert the operating unit.
	The operational contacts are soiled.	Clean the operational contacts.
	The ignition is turned off.	Turn on the ignition.
	The connection cables haven't been attached correctly.	Please check if all cables have been attached correctly.
	The fuse is blown.	Replace the fuse.

Problem	Cause	Solution
The device doesn't retain the stored stations	The radio hasn't been connected correctly.	Please check if all cables have been attached correctly.
	The device temperature is too high.	Reduce the volume of the device.
	Contacts 4 and 7 haven't been connected properly or the vehicle manufacturer has assigned these in reverse.	Contact your vehicle manufacturer or a specialised workshop and purchase a fitting adapter set there.
Data carrier isn't being drawn in completely.	Data carrier wasn't recognized by the insertion technology.	Remove the data carrier and insert it again.
The inserted CD/DVD can't be played.	The CD/DVD was inserted with the printed side to the bottom.	Flip the CD/DVD over and try again.
	The CD/DVD has too many scratches.	Create another CD/DVD from the original or have the CD/DVD repaired.
	The CD/DVD is dirty.	Clean the CD/DVD (without cleaning materials, just a lint-free cloth).
	The device temperature is too high.	Reduce the volume of the device.
	The coating on the data carrier is faulty (very rare)	Purchase another type of data carrier and create the data carrier again.
	The CD/DVD contains incorrect or faulty data.	The CD/DVD can't be used with this device. Please burn your audio data onto a separate data carrier and try again.

Problem	Cause	Solution
Bad radio reception	Reception conditions are bad.	Change your location to achieve better reception.
The radio reception is choppy or frequently interrupted.	The AF function is activated.	Deactivate the AF function.
The radio only receives few stations	The REG function is activated.	Deactivate the REG function.
The music is only played back by one speaker group	The BALANCE and/or FADER settings are faulty.	Check the BALANCE or FADER settings.
NO FILE	The CD doesn't meet the CompactDisc standard or doesn't contain any MP3 / WMA files.	Create a CD that meets the CompactDisc standard.
Not all MP3/WMA/OGG tracks are played back.	Wrong coding of the files that aren't being played back.	Recode the files.
	Too many files are stored on the CD.	A maximum of 1000 tracks can be administered per CD. Create a CD with less than 1000 tracks.
The message: "Warning!! Enjoy sound only while driving" appears during the playback of a DVD.	The parking brake is not engaged or the cable that connects the device to the parking brake switch has come loose.	Please engage the parking brake. This is a protective function, since the legal requirements prohibit a visual display for the driver during a drive. If required, have the cable for the parking brake checked for any damages.