



Quantitative measurement equipment
for flare in the anterior chamber

Laser Flare Meter

KOWA FM-600

Instruction Manual



KOWA FM-600

EU

INTRODUCTION

INTRODUCTION

Accept our congratulations on your purchase of Laser Flare Meter KOWA FM-600 (referred to as FM-600 in this manual).

This manual provides a description of the operation procedures of FM-600 along with important precautions to be observed during its use.

Please read this entire manual carefully to assure that the instrument can demonstrate its full capabilities and be used effectively.

After you have finished reading it, please keep it in an easily accessible location near the instrument for future reference.

INTENDED USE

FM-600 is an instrument to measure the protein level contained in aqueous humor of the anterior chamber.

Operational Considerations for Safety

This manual describes important precautions to be observed during its use to assure that the instrument can be used safely without causing any damage to the human body and property of its purchaser and other persons. The designations and their pictorial symbols have the following meanings. These should be fully comprehended before reading the text of this manual.

■ Meanings of Designations

Warning

If the instrument should be operated wrongly, there may incur a risk of causing death or serious injury.

Caution

If the instrument should be operated wrongly, there may result in a bodily injury (not so serious as to cause death)*¹ or damage to property*².

* 1: A bodily injury means an injury, burn, electrical shock and so forth that will not necessitate hospitalization or long-term outpatient treatment.

* 2: Damage to property means an extensive damage to the house and household goods as well as the domestic animal and pet.

■ Meanings of Symbols



Graphical indication of any danger (including warning and caution). What is warned is explicitly and pictorially indicated by a picture or its associated message on or near a pictorial symbol.



Graphical indication of prohibited operation (prohibitive item). What is prohibited is explicitly and pictorially indicated by a picture or its associated message on or near a pictorial symbol.













Graphical indication of mandatory action (obligatory item). What must always be done is explicitly and pictorially indicated by a picture or its associated message on or near a pictorial symbol.







■ Kowa is not responsible for;

- Any damage caused by fire, earthquake, third party's action, any other accident or user's intentional or unintentional error, abuse or use under abnormal conditions;
- Any damage resulting from use of the product or its malfunction (e.g. operating loss, shutdown, change/loss of stored data and so forth).
- Any damage resulting from disobedience of what is described in the instruction manual.
- Any damage resulting from, for instance, malfunctioning of instrument caused by a combination of connected devices.

⚠ Warning

 Unplug	If any abnormal smell or sound, or overheating or smoke should be detected, be sure to turn OFF the main power immediately and then unplug the instrument from the power outlet. Continued use of the instrument may cause the instrument to malfunction or cause a fire. Contact your Kowa dealer where you have purchased the instrument or your nearest repair shop for inspection.	
 Unplug	 Warning / High-Voltage	When replacing the fuse, be sure to turn OFF the main power and unplug the instrument from the power outlet. Removing the fuse holder cover without unplugging the instrument may cause electrical shock.
 Obligatory	Be sure to plug into the power outlet completely and securely. Doing otherwise may cause a fire or electrical shock.	
 Obligatory	Use only a specified fuse. Doing otherwise may cause a device failure or fire.	
 Obligatory	Be sure to ground the instrument properly and securely in order to avoid bodily injury. Be sure to connect the plug in the three-wire grounding type socket. Doing otherwise may cause electrical shock.	
 Warning	Be sure that the tips of instrument are not in contact with the eye and the nose of the patient when in operation. (The patient may be injured.)	
 Prohibitory	Do not place a cup or a glass containing liquid or the like on or near the instrument. Spilling liquid into the instrument may cause electrical shock. If liquid should be spilled into the instrument, turn OFF the main power, and unplug the instrument from the power outlet. Contact your Kowa dealer where you have purchased the instrument or your nearest repair shop for inspection.	
 Disassembly prohibited	Do not disassemble, modify or repair the instrument yourself. Doing so may cause a fire, electrical shock, instrument malfunctioning or bodily injury. Contact your Kowa dealer where you purchased the instrument for repair. The product assembled by yourself will not be covered under warranty nor any other service.	
 Prohibitory	Do not load the socket or plug board with excess of its rated capacity. If the main power cord should share a power outlet with other devices and the rated capacity is exceeded, there may cause a fire or electrical shock.	

⚠ Caution

 Obligatory	The power supply must be provided for the sole use of this instrument. Sharing one and the same power supply with other devices may cause FM-600 to malfunction.
 Prohibitory	Do not pull the electrical cord when unplugging. Doing so may damage the cord and cause a fire or electrical shock. Be sure to hold the plug when unplugging the instrument.
 Prohibitory	Do not plug or unplug the power cord with wet hand. Doing so may cause electrical shock.
 Prohibitory	Do not install the power unit at unstable location such as on a shaky base or a tilting surface. Doing so may cause the instrument to drop or fall over and result in a bodily injury.
 Prohibitory	Do not wipe the exterior of the instrument with solvent such as benzene, alcohol, thinner and ether. Doing so may cause discoloration or degradation.
 Unplug	If the instrument is not to be in use for a long period of time, unplug the power cable. Leaving the power cable plugged may cause a fire.

Location of Cautionary Marking

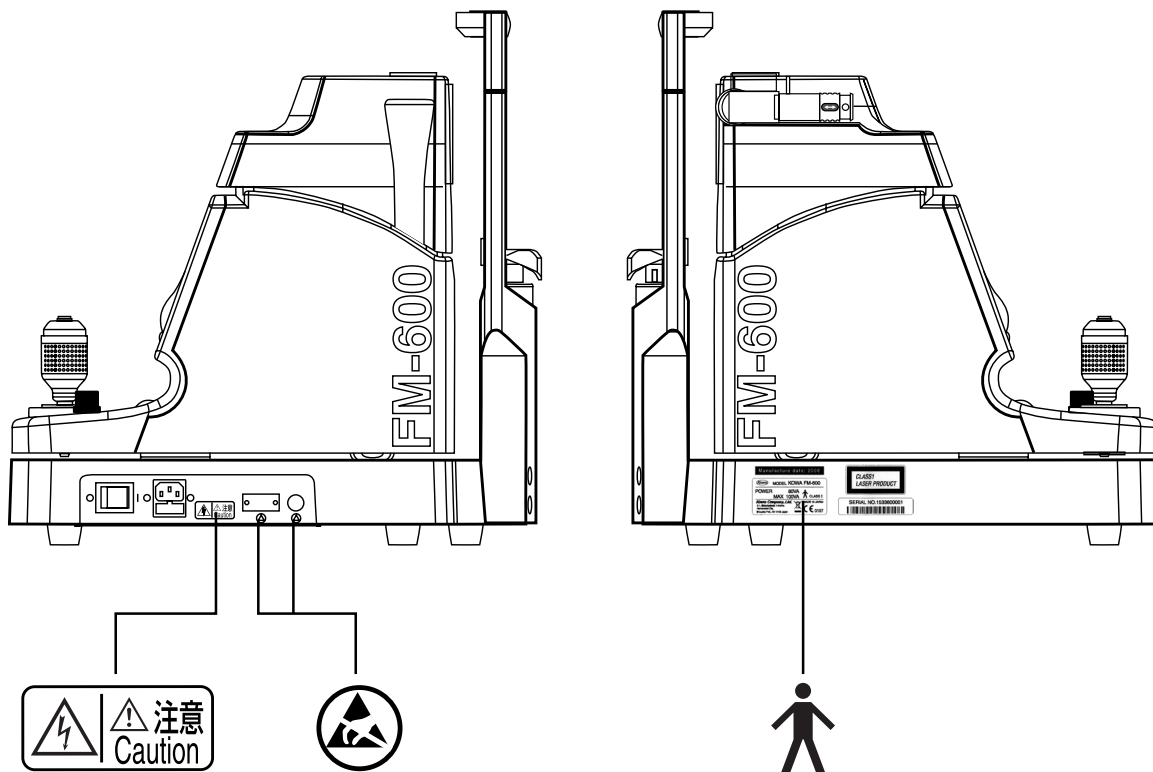

Description of Labels and Symbols

	<p>Before replacing fuse, be sure to turn OFF the main power and unplug the instrument. Removing the fuse holder cover without unplugging the instrument may cause electrical shock.</p>
	<p>Do not touch directly the connector pins that are labeled with the symbols shown in the left. * For details, please refer to p.36 [About electromagnetic compatibility (EMC)].</p>
	<p>Type B applied parts (degree of protection of applied part against electric shock).</p>
	<p>Alternative Current</p>
	<p>ON</p>
	<p>OFF</p>
<p>CLASS 1 LASER PRODUCT</p>	<p>Laser Class based on IEC60825-1:2001</p>

Precautions Concerning Use

- Handle the instrument with care, and do not apply strong shock to it. Also, do not leave any objects on the instrument.
- Always cover the system when not in use in order to protect its components.
- Avoid high temperature and humidity, direct sunlight, and dust when shipping, installing, and storing the instrument. Strictly observe the following environmental conditions. When in use, in storage or in transit, environmental conditions described below must be observed strictly in order to protect the instrument from condensation.

	In operation	Transportation, storage
Ambient Temperature	10 - 40 °C	-15 - +50 °C
Relative Humidity	30 - 60 %	10 - 95 %

Precautions Concerning Use of Electrical System

- If the instrument is not to be in use for a long period of time, turn OFF the main power and unplug the instrument.
- Install the system in a location where there is little risk of the plug being pulled out. If the plug should be pulled out accidentally, be sure to turn OFF the main power before plugging the system back in.
- The manufacturer is not liable for malfunctions and/or damages resulting from maintenance and/or repairs performed by persons other than the specified repair service.

Precautions Concerning Disposal of the Instrument

- The liquid crystal display of this instrument contains mercury. When disposing of this instrument, comply with the regulations of countries or areas in which the instrument is used.

Other Precautions

- Never disassemble or adjust this instrument by yourself since it uses precision parts which requires special tool for doing so.
- It is recommended that this instrument be used where ambient illumination is evenly distributed at 100 lx or less (400 lx or less when using an optional light shielding cover).
- Take the history of the patient's medical history; once it is confirmed that there will not be a problem with using mydriatic agent, administer mydriatic drops to him/her regardless of the level of ambient illumination.

◆ Precautions during Operation

- Use special caution when operating the instrument to avoid hands being caught in the areas indicated with arrows in the illustration below.
- There is an air vent on the bottom surface of the instrument. When installing the instrument, do not obstruct the vent.

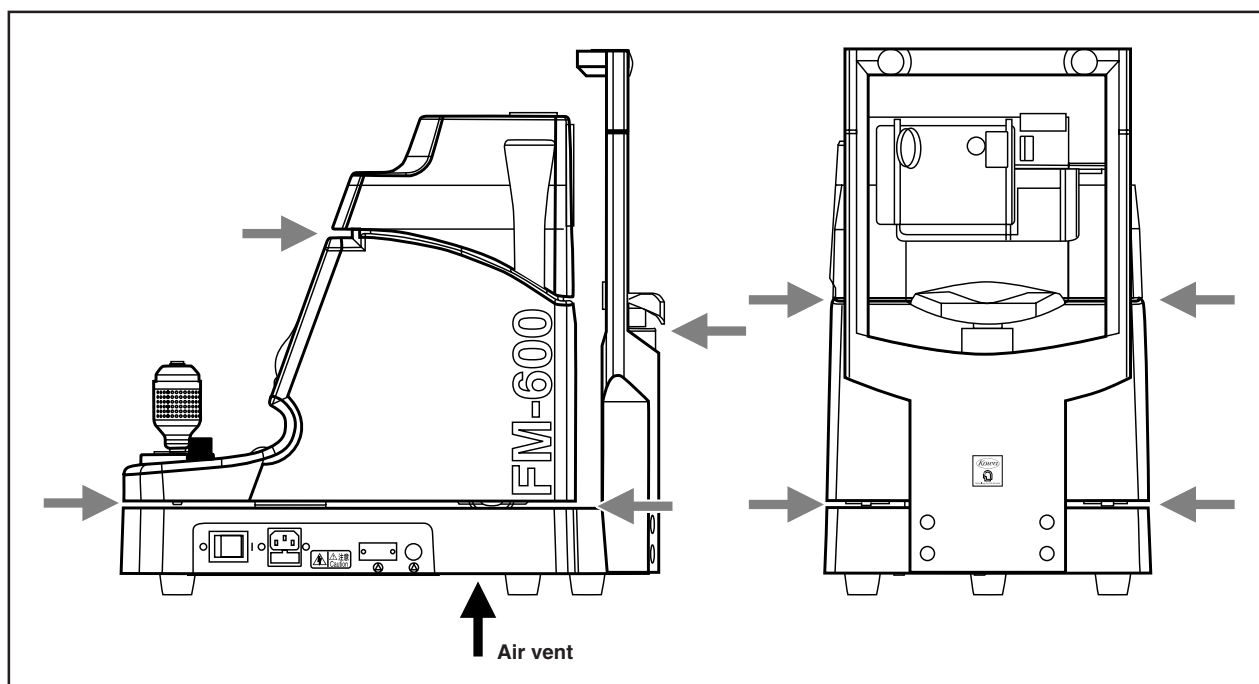

Precautions (Safety Precautions and Hazard prevention) Concerning Use of Medical Electrical Instrument

- 1. Instrument should be operated only by qualified personnel.**
- 2. The following precautions must be observed when installing the instrument:**
 - (1) Install at a location free of moisture.
 - (2) Install at a location where there is no risk of detrimental effects caused by atmospheric pressure, temperature, humidity, ventilation, sunlight, dust, salt, or air containing sulfur and so forth.
 - (3) Install the instrument in a stable manner, avoiding inclines, vibrations and shock (including those during transport).
 - (4) Do not install in locations where chemicals or pharmaceuticals are stored or where there is generation of gas.
 - (5) Use the proper power supply, frequency, voltage and allowable current values (or power).
 - (6) Check the status of battery-operated power supplies (degree of discharge, polarity, etc.).
 - (7) Be sure that the instrument is properly grounded.
- 3. The following precautions must be observed before using the instrument:**
 - (1) The instrument must be inspected for switch contact, polarity, dial settings and meter readings to confirm its proper operation.
 - (2) Be sure that the instrument is properly grounded.
 - (3) Be sure that all cords are connected properly and securely.
 - (4) Avoid combined use of instruments since this can lead to inaccurate diagnosis and hazards.
 - (5) Re-inspect any external circuits that come in direct contact with patients.
 - (6) Check all battery-operated power supplies if applicable.
- 4. The following precautions must be observed while using the instrument:**
 - (1) Do not exceed the time and quantity required for diagnosis and treatment.
 - (2) Continuously monitor the instrument for any abnormalities as well as the condition of the patient.
 - (3) When an abnormality is noticed in the instrument or the patient, take appropriate measures, such as to terminating operation of the instrument while ensuring the safety of the patient.
 - (4) Do not allow the patient to touch the instrument.
- 5. The following precautions must be observed following use of the instrument:**
 - (1) Follow the specified procedures to return all operating switches, dials and other components to their positions prior to use; then turn OFF the main power.
 - (2) When disconnecting cords, hold the plug body firmly so as not to apply excessive force to the cord itself.
 - (3) The following items must be observed with respect to the location where the instrument is stored.
 - (a) Store in a location free from moisture.
 - (b) Store in a location where there is no risk of detrimental effects caused by atmospheric pressure, temperature, humidity, ventilation, sunlight, dust, salt, or air containing sulfur and so forth.
 - (c) Store in a stable manner while paying attention to inclines, vibrations and shock (including those during transport).
 - (d) Do not store in locations where chemicals or pharmaceuticals are stored or where there is generation of gas.
 - (4) Store all accessories, cords, leads and other components in an organized manner after cleaning.
 - (5) Be sure to clean the instrument so that it functions properly the next time it is used.
- 6. If the instrument should malfunction, the operator should not attempt to correct the problem. Appropriately indicate that the instrument is not operating properly and await repairs by qualified personnel.**
- 7. Never attempt to disassemble or modify the instrument.**
- 8. Maintenance and inspection**
 - (1) All instrument and components should be inspected regularly.
 - (2) When resuming use of instrument that has not been used for a long period of time, always confirm that the instrument operates properly and safely before use.
- 9. Beware that strong electromagnetic waves may cause the instrument to operate incorrectly.**

This instrument has been tested based on JIS T0601-1-2:2002 and IEC60601-1-2:2001. The purpose of these standards is to maintain safety against the dangerous obstacle in typical medical facilities. However, the instrument may affect or be affected by certain equipment such as cellular phones and pace makers.

In case this instrument is influenced by other equipment, or it affects other equipment, or there is such fear, relocate and/or increase the distance between FM-600 and affecting equipment.

Should there be any further questions and/or unknown points, please consult your Kowa sales representative or dealership beforehand.

Accessories



Power cable (1)	Fuse (2)	Dust cover (1)
		
Chin-rest paper (1)	Chin-rest's pin (2)	Printer paper (2)
		
Instruction Manual (1)		
		

Table of Contents

Introduction	1
Precautions Concerning Use	4
Precautions (Safety Precautions and Hazard Prevention) Concerning Use of Medical Electrical Instrument	5
Accessories	6
Table of Contents	7
1. Principle of operation	9
2. Names and functions of components	10
2-1 Names and functions of components	10
2-2 Screen display details	13
3. Setting up	15
3-1 Installation	15
3-2 Printer paper installation	15
4. Basic aligning procedure	16
4-1 Coarse lengthwise / crosswise adjustment	16
4-2 Fine lengthwise / crosswise adjustment	16
4-3 Measurement switch	16
4-4 Frontal view switch	16
5. Calibration	17
5-1 Calibration	17
5-2 Light shielding cover	18
6. Procedure for measurements	19
6-1 Procedure for measurements: Overview	19
6-2 Ocular height adjustment	19
6-3 Frontal view alignment	19
6-4 Diagonal view alignment	20
6-5 BG check	21
6-6 Measurement	21
6-7 Displaying measurement results	22
6-8 Viewing and editing acquired data	23

Table of Contents

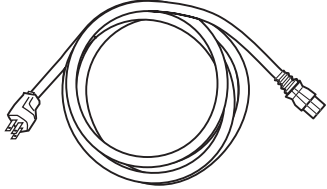
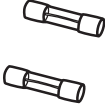
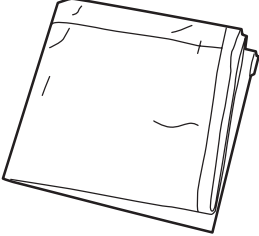
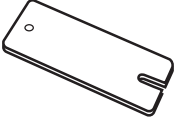
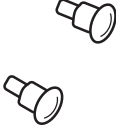
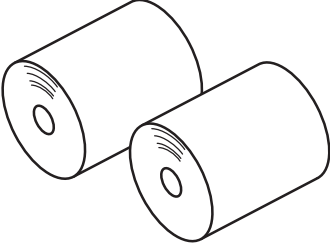
7. Tips for measurements	24
7-1 How to block laser beams	24
7-2 Warning beep during BG check	24
7-3 Recommended procedure when BG check obtains no correct alignment	24
7-4 Recommended procedures when BG check obtains no good result	24
7-5 Recommended procedures when measured waveforms are offset to left or right	25
8. Configuration and settings	26
9. Miscellaneous	28
9-1 ID input	28
9-2 Connecting external devices	28
9-3 Display messages	30
9-4 Function switches	31
9-5 Relocation	31
10. Troubleshooting	32
10-1 Phenomena and validation	32
10-2 Error messages	32
11. Maintenance/Inspection	33
11-1 Daily maintenance	33
11-2 Daily inspection (by the user)	33
11-3 Fuse replacement	34
11-4 Chin-rest paper installation	34
11-5 Sterilization of Forehead stopper and Chin-rest	34
11-6 Refilling and replacing consumables	34
11-7 Regular inspection (by the device supplier)	34
11-8 Repairing	34
12. Specifications	35
12-1 Specifications	35
12-2 Applicable safety standards and Classification	35
13. Electromagnetic Compatibility	36
14. Photochemical Hazard (ISO 15004:1997)	39

1. Principle of operation

Weak scattered light induced by laser beam entered into the anterior chamber is detected and used for measurements. It is known that intensity of the scattered light is proportional to the protein level contained in aqueous humor of the anterior chamber. However, intensity of the scattered light may vary if there is a difference in the protein composition between aqueous humor samples at the same protein concentration.

We refer to this scattered light intensity as "flare value" and indicates the value using photon count per millisecond in this device.

- * Photon count is the number of pulses output from photomultiplier when scattered light is detected. This value may be converted into an albumin level. Bovine albumin solution at 100mg/dl equals to 13 Photon counts per millisecond.

⚠ Caution

Note that some factors including circadian rhythm, age, mydriasis, and drug may affect flare values. Measurement must be taken carefully taking any of these factor in account. The accuracy of the reading may be affected by disorders shown below:

- * Intensive lens clouding, corneal edema, corneal opacity, the anterior chamber with an artificial lens implanted, shallow anterior chamber, and achromatic eye.

■ Details ■

Measurements

Optical system is composed of a laser beam emitter and a photoreceiver positioned at a orthogonal to the axis of the beam. The scanning laser beam emitted through a condensing lens is focused at the anterior chamber or target point. Scattered light from the anterior chamber goes through a photoreceiver lens and comes into a focus at a photoreceiver mask. The photoreceiver mask has an important role to create a reading window within aqueous humor of the anterior chamber. Scattered light coming through the mask reach to a photoreceiver element (or a photomultiplier tube) where it undergoes a photo-electro conversion process. Then, the collected data is analyzed at the analyzer unit to determine a flare value. Results are shown in the display.

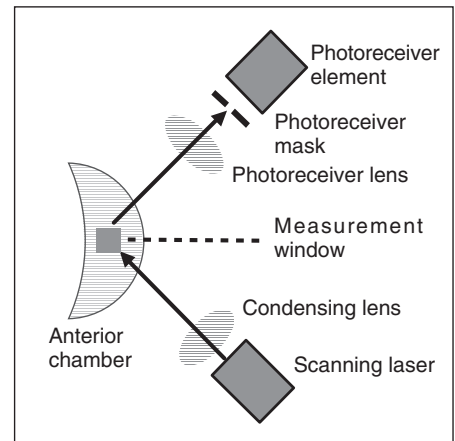

Figure 1-1

Details of flare reading

An area including the Measurement window is scanned with laser beam. As a result, a waveform shown in Fig. 1-2 is obtained. Background Signal 1 (BG1) obtained when laser beam is located below the a Measurement window and Background Signal 2 (BG2) obtained when laser beam is located above the a Measurement window are scattered light noise from intraocular tissue, while Flare Signal (SIG) is a sum of scattered light from protein and scattered light noise from intraocular tissue.

Therefore, intensity of the scattered light caused by the protein concentration in aqueous humor of the anterior chamber is calculated using the formula:
$$\text{SIG} - (\text{BG1} + \text{BG2})/2.$$

A result obtained using this formula is called "flare value" and represented as photon count per millisecond.

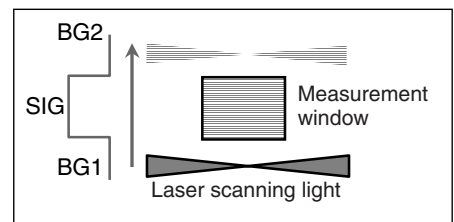
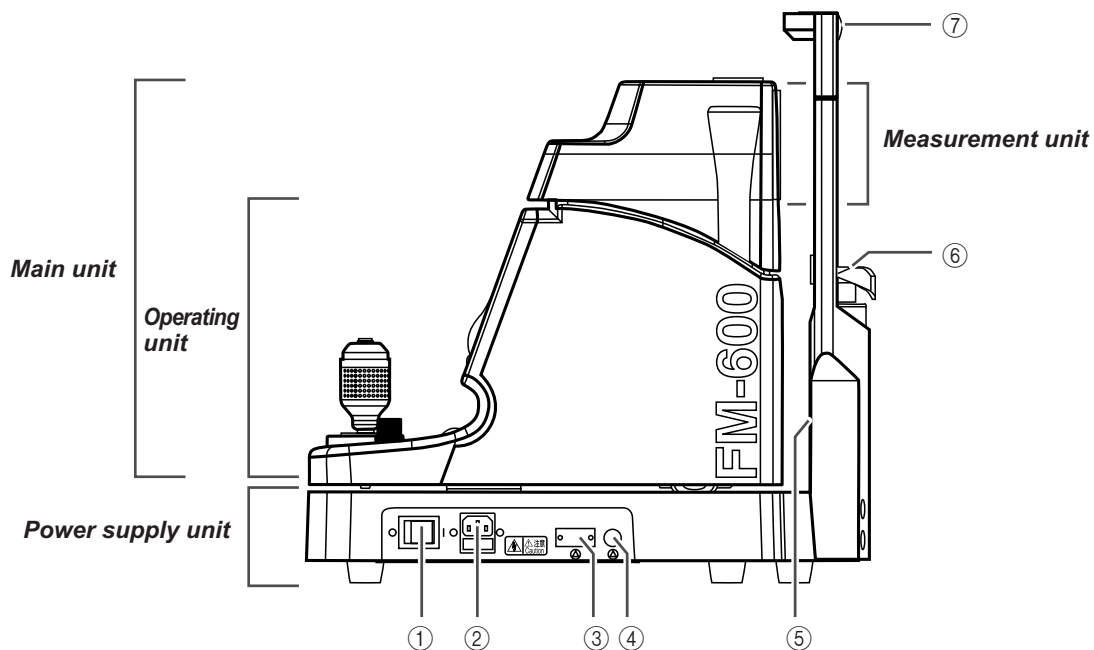

Figure 1-2

2.

Names and functions of components

2-1 Names and functions of components



- ① **Power switch**
○ : OFF | : ON
- ② **Power supply inlet**
Where a power supply cord is connected.
A fuse holder is provided.
- ③ **External device I/O terminal (for a communication cable)**
Used for connecting a PC to which measurement data outputs are transmitted.
- ④ **External device I/O terminal (for a ten key pad)**
Used for connecting a ten key pad.
- ⑤ **Chin-rest illumination**
Used for illuminating indirectly the patient's eyes from a lower level than the eyes (used in dark room).
- ⑥ **Chin-rest**
Used for holding patient's chin on it. A sheet of chin-rest paper may be attached.
- ⑦ **Forehead rest**
Used for holding patient's forehead.
The screw holes on the top are used for installing a light shade (optional accessory) .

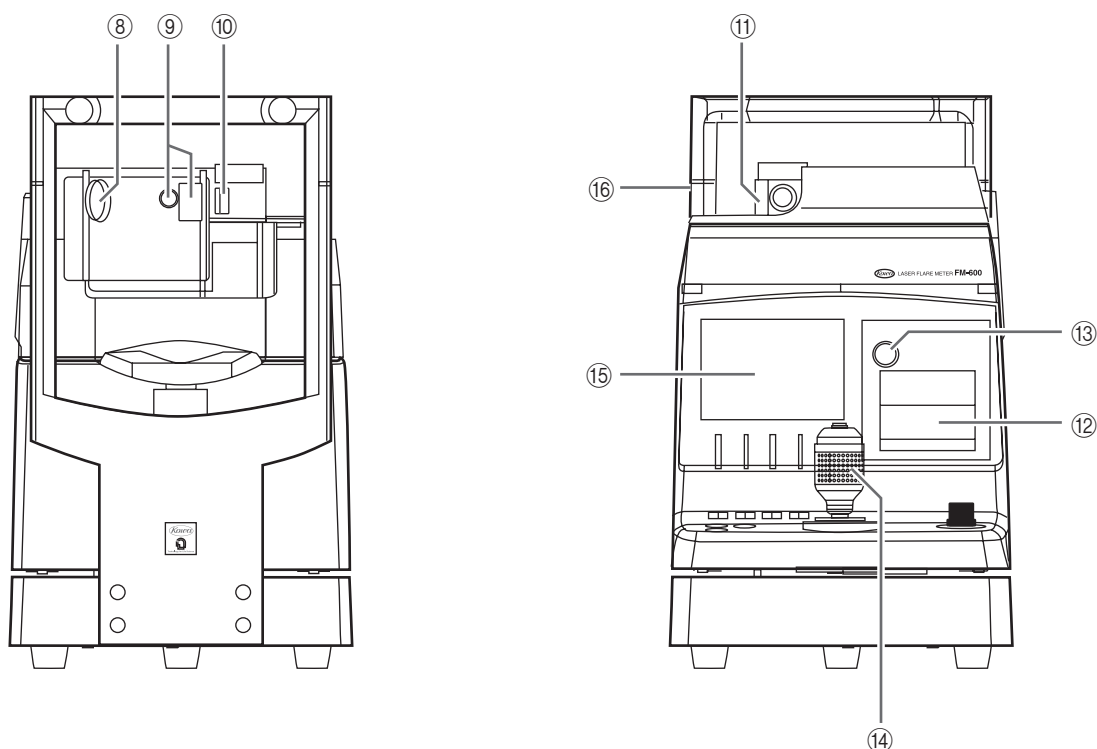

- ⑧ **Photoreceiver lens**
The lens that mainly receives scattered light.
- ⑨ **Front camera and Eye fixation lamp window**
Used for monitoring a patient's eye. The patient may see the eye fixation lamp inside.
- ⑩ **Light emitting lens**
Used for emitting laser beam and alignment light.
- ⑪ **Calibrator**
Used for calibrating the device.
This may be used as a laser beam attenuator when located in between a measuring position and a calibrating position.
- ⑫ **Printer**
Used for printing the results obtained.
- ⑬ **Printer lid button**
The printer lid opens when the round dimple is pushed.
Used for replacing printer paper.
- ⑭ **Joy stick (rubber ring)**
Hold and move this joy stick to move the Main unit lengthwise or crosswise for a longer distance.
Tilt this joy stick to move the Main unit lengthwise or crosswise for a shorter distance.
Turn the rubber ring to ascend or descend the Measurement unit.
- ⑮ **Display**
Used for displaying Images for monitoring and obtained measurement results.
Also used for displaying each function.
- ⑯ **Eye level mark**
This mark is a suitable position of the patient's eye on measurement.

2. Names and functions of components

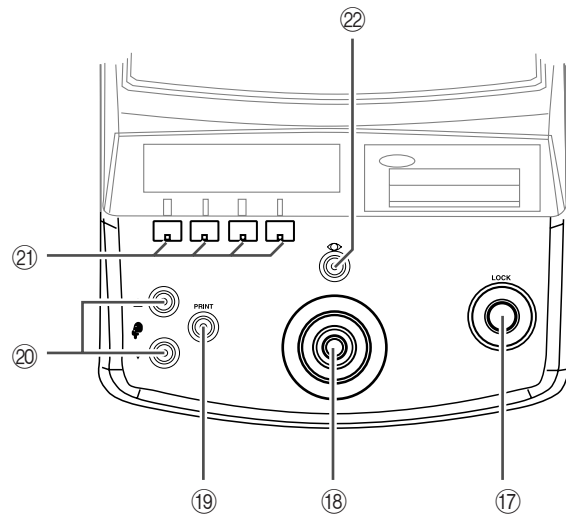

- ⑰ **Self-locking screw**
Tightening this screw lock the Main unit.
- ⑱ **Measurement switch**
Pushing this switch proceeds with Frontal view alignment screen → Diagonal alignment screen (BG check) → Start measurement.
- ⑲ **Print switch**
Pushing this switch allows contents in the display to be printed or output (only when light is lit).
- ⑳ **Chin-rest ascending/descending switch**
Used for ascending and descending Chin-rest.
- ㉑ **Function switches ***
Operates as they are assigned in accordance with each screen.
- ㉒ **Switches for frontal view**
Pushing this switch switches the current display screen to Frontal view alignment screen (only when the light is).

* Function switches

Functions assigned to the [Function Switch Display Area] (refer to Page 13) may vary depending on the screen you have chosen. Each of functions shown in each screen is selected and executed by pushing the corresponding function switch. In this manual, “select [xxx]” means pushing the corresponding function switch.

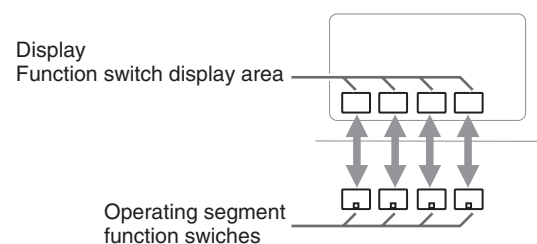

■ 2-2 Screen display details

Detail of each screen display

■ Frontal view alignment screen ■

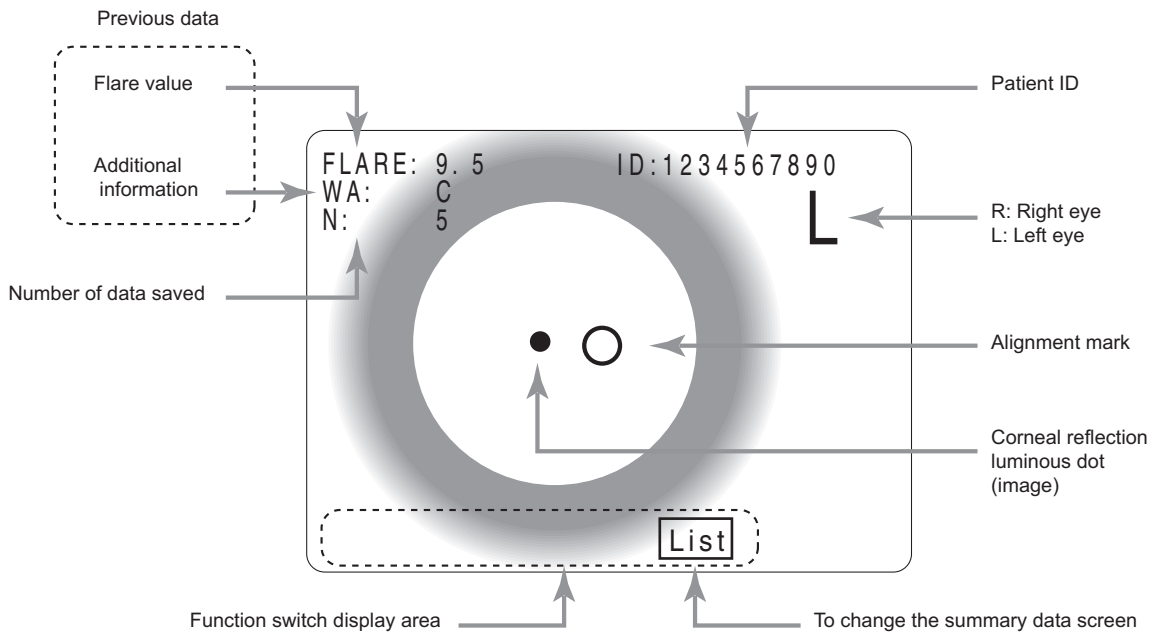

■ Diagonal alignment screen ■

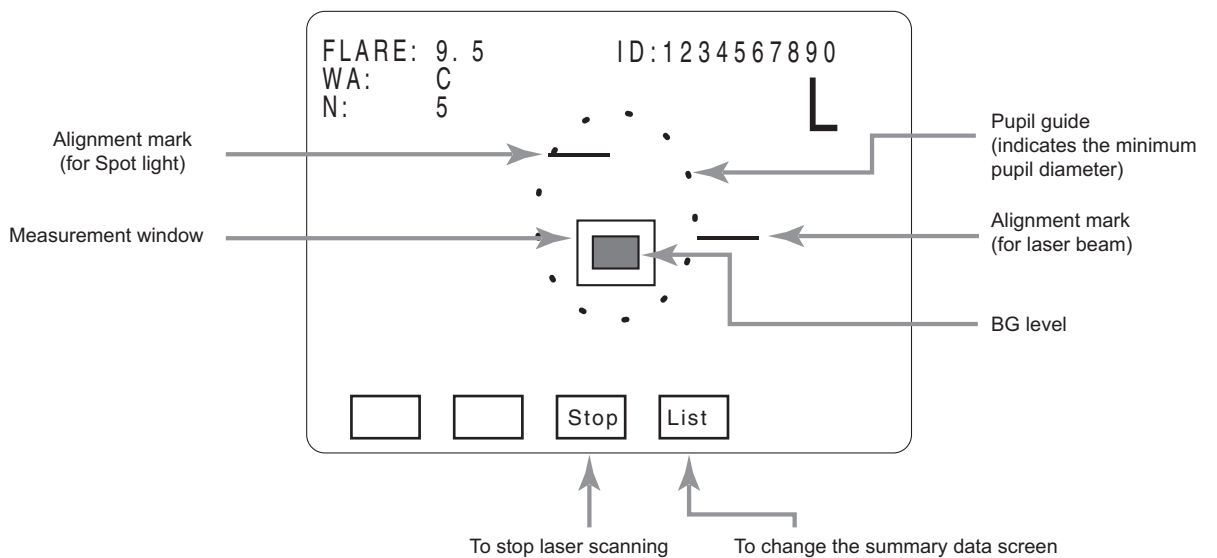

2. Names and functions of components

■ Measurements graph screen ■

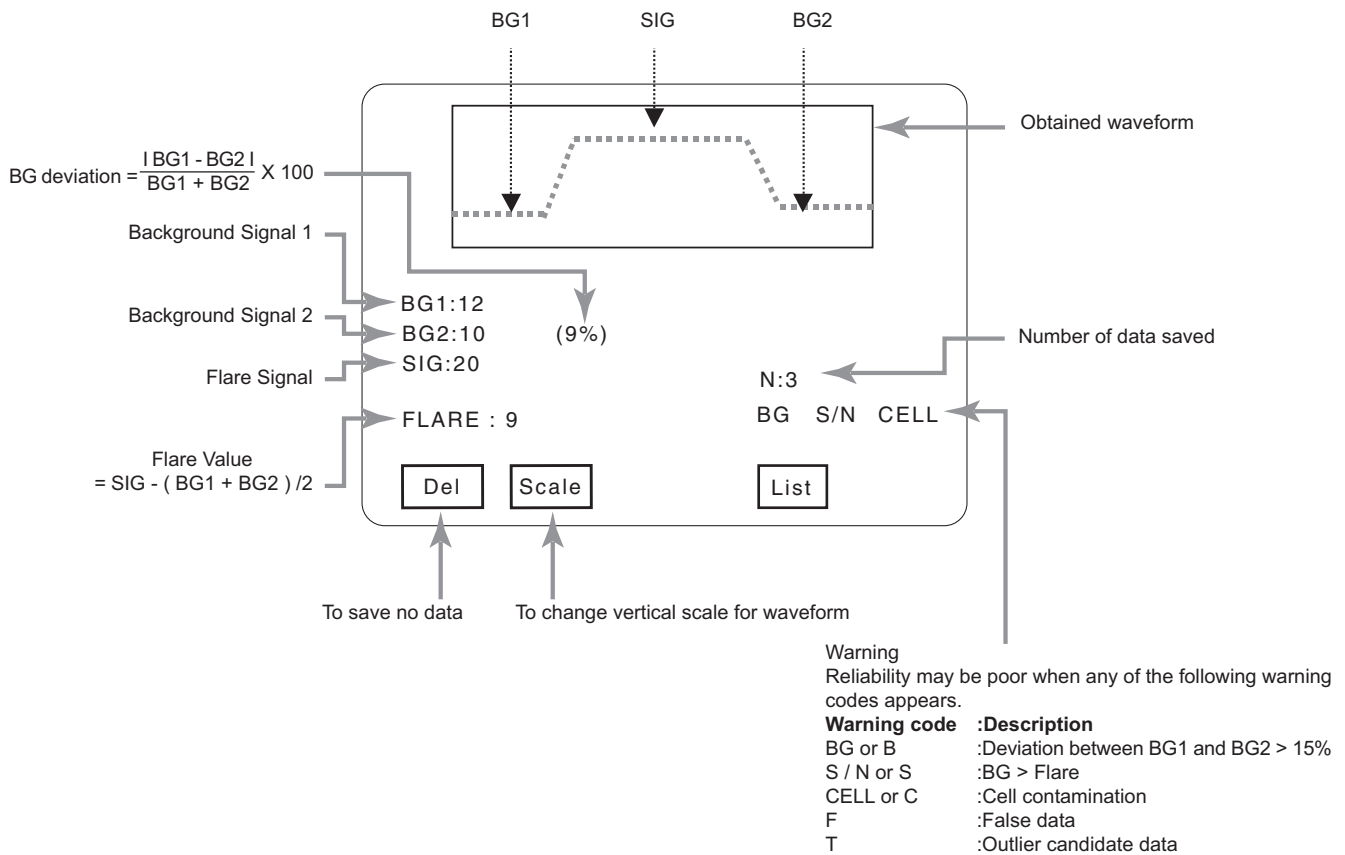

■ Summary data screen ■

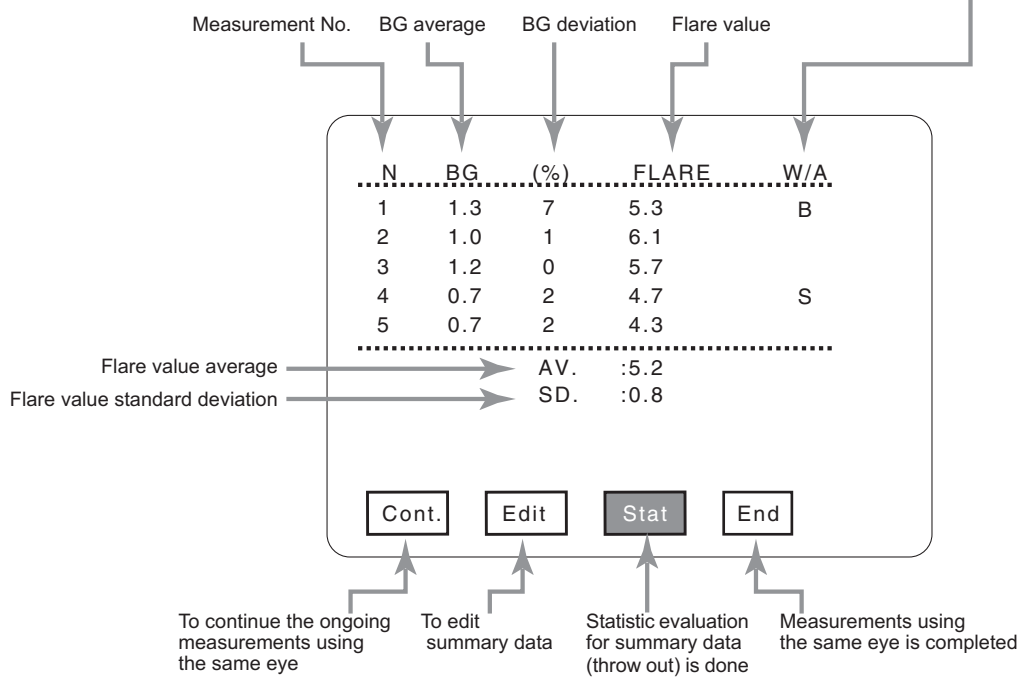

3.

Setting up

3-1 Installation

Fig. 1

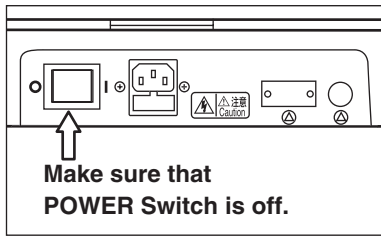

Place the device on a motorized table (optional accessory).
Make sure that POWER Switch shown in Fig. 1 is at OFF position (O).
Connect the power cable to the power supply inlet and connect the other end of the cable to a nearby wall outlet.

Warning

Connect a ground cable securely to avoid injury. Connect the power supply cable to a grounding receptacle for a triplex cable.

3-2 Printer paper installation

Fig. 2 Printer lid button

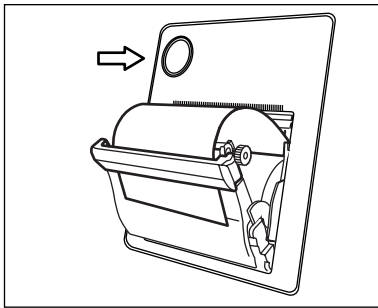

The printer lid opens when the round dimple "Printer lid button" is pushed.
Install a printer paper as shown in Fig. 2 and close the lid.

Fig. 3

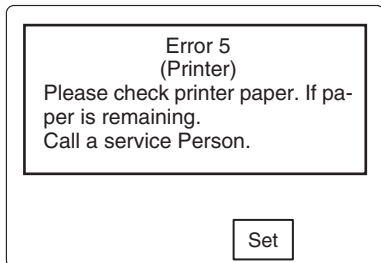

When no printer paper is installed or Printer switch is pressed while the lid is kept open, "Please check printer paper. If paper is remaining. Call a service Person." (see Fig. 3)* is displayed.

Make sure there is a printer paper and the lid is closed and push "Set".
If the same message appears continuously, call a service person.

* This message does not appear when output mode is set to EXT. See "8. Configuration and settings" for details.

4. Basic aligning procedure

Explanation how to operate.

■ 4-1 Coarse lengthwise / crosswise adjustment

Fig. 1

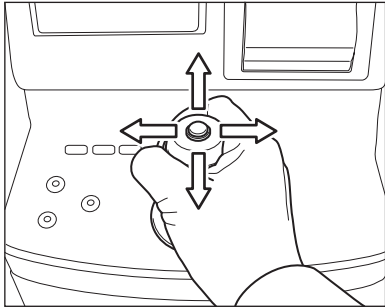

To move the Main unit lengthwise or crosswise for a longer distance, hold and move the joy stick steadily (Fig. 1).

■ 4-2 Fine lengthwise / crosswise adjustment

Fig. 2

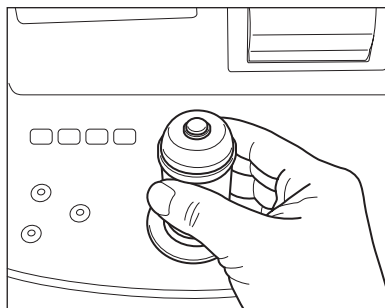

To move the Main unit lengthwise or crosswise for a shorter distance, lightly hold the joy stick end with your finger tips and tilt the joy stick (Fig. 1). Turn the rubber ring to ascend or descend the Measurement unit (Fig. 2).

■ 4-3 Measurement switch

Fig. 3

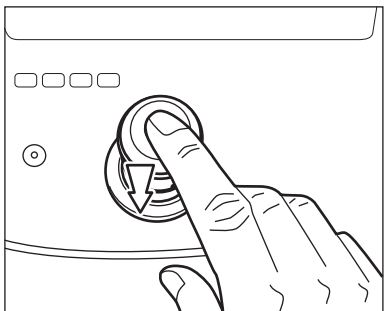

Use this switch to change from coarse adjustment (Frontal view alignment screen) to fine adjustment (Diagonal alignment screen) or start a Measurement (Fig. 3).

■ 4-4 Frontal view switch

Fig. 4

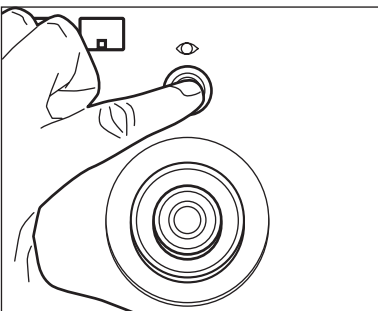

Use this switch to change from fine adjustment (Diagonal alignment screen) to coarse adjustment (Frontal view alignment screen) or return to fine adjustment (Diagonal alignment screen) from post-measurement (Measurements graph screen) (Fig. 4).

⚠ Caution

Assure that the patient's eye or nose does not contact with the device during this procedure.

⚠ Caution

When handling the Main unit, try not to place your hand between the Main unit and the Power Supply unit or the chin-rest post and the Forehead Rest, or into the space underneath the chin-rest.

5. Calibration

⚠ Caution

Stained lens may affect measurements.

It is recommended to calibrate regularly in order to obtain accurate measurements.

A message will appear during device start-up if the device had no calibration done for more than a month. Calibrate the device as soon as possible when the message appears.

Follow the calibration procedure described below.

It is recommended to calibrate the device in a dark room. Use a light shade (optional) when calibrating in a well-lighted room.

■ 5-1 Calibration

Fig. 1

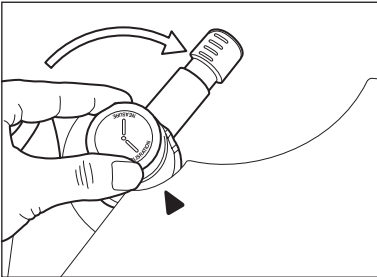

- ① While Frontal view alignment screen is displayed, turn Calibrator to CALIBRATION position.

If the display shows "LD Temp check Please wait", wait until the message disappears.

If the display shows "Laser Attenuating ...", turn Calibrator until the message shown in Fig. 3 appears in the display.

If the display shows "The acquired data is deleted. Is a calibration carried out ?" indicating there is acquired data, select "Yes" to proceed to the calibration.

Fig. 2

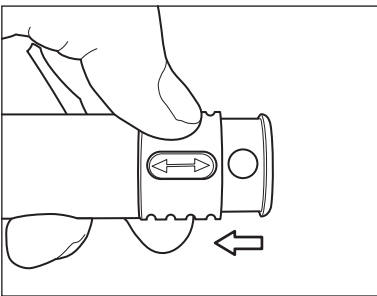

- ② Slide the protective cap aside to expose the window (Fig. 2).

Caution: Do not stain the glass surface located deep inside the calibrator.

Fig. 3

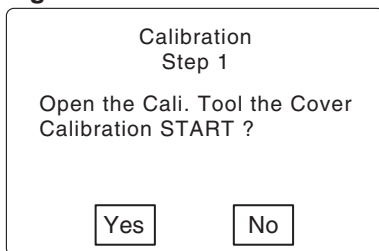

- ③ When "OK" is selected in the screen shown Fig. 3, "Calibration Tool's Value" input screen appears.

Fig. 4

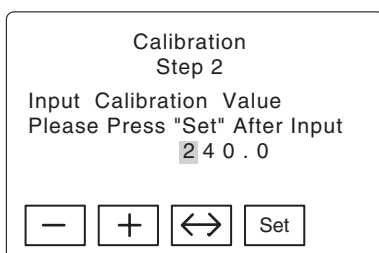

- ④ Input the number shown in the label attached to the calibrator with using " - " " + " " ↔ " *.

After this input, select "Set" to start calibration.

Calibration is automatically executed in accordance with pre-programmed steps.

* Although the number has been already input into the device at the factory, please verify if the number was input correctly.

5. Calibration

Fig.5

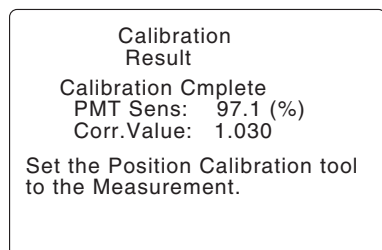

⑤ Fig. 5 is displayed when calibration is completed.

Fig. 6

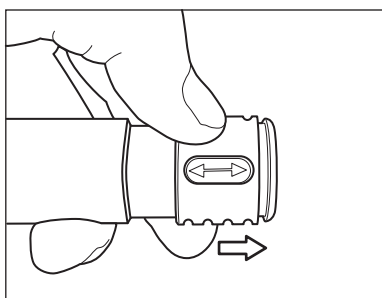

⑥ Slide the protective cap back into the original position, and turn Calibrator counterclockwise to MEASUREMENT position (Fig. 6).

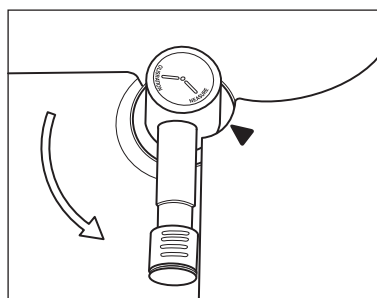

■ 5-2 Light shade

Fig. 7

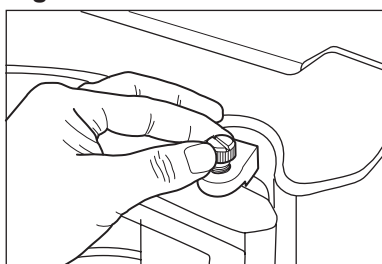

Remove the white cap using a paper clip or other pointed object and install a light shade (optional) using the screw holes on the top of the device (Fig. 7).

Fig. 8

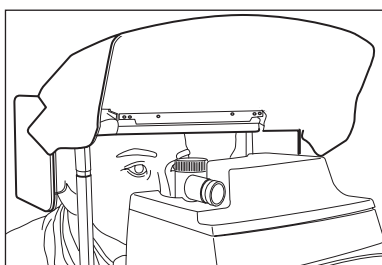

When you need to directly check the level of a patient's eye, lift the light shade as shown in Fig. 8.

Fig. 9

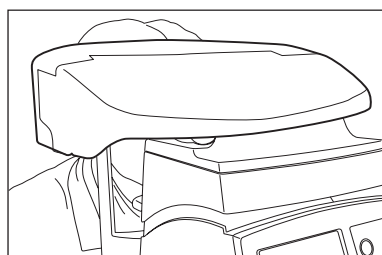

Close the light shade as shown in Fig. 9 for calibration, BG check, and measurement.

6. Procedure for measurements

6-1 Procedure for measurements: Overview

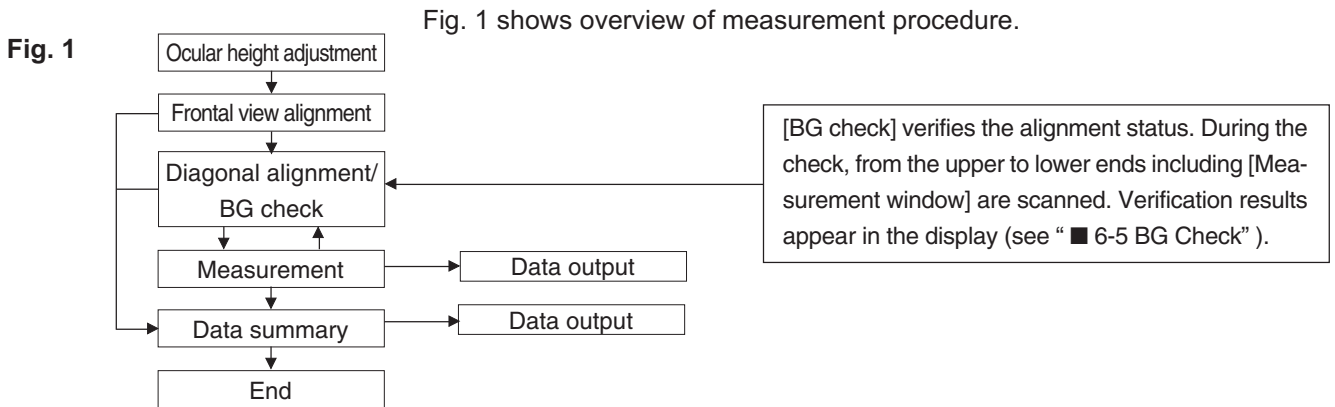

6-2 Ocular height adjustment

Fig. 2

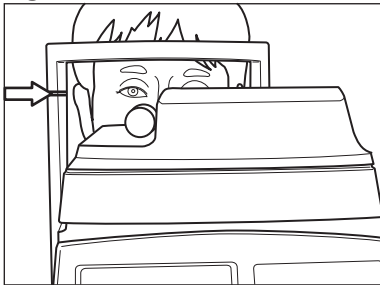

Align Eye Level Mark with the patient's eye.

Put POWER Switch into ON position " | ". Pull back Main unit and ask the patient to sit in front of the device. Ask the patient to rest his or her chin on Chin-rest and forehead on Forehead rest. Move Main unit to the right proximal position where you can see the right eye directly. Ascend or descend Chin-rest to align Eye Level Mark (Fig. 2 ⇔) with the patient's eye. Using Calibrator as an index, place Measurement unit to the same position. Adjust crosswise position of Main unit to the patient's eye.

6-3 Frontal view alignment

Fig. 3

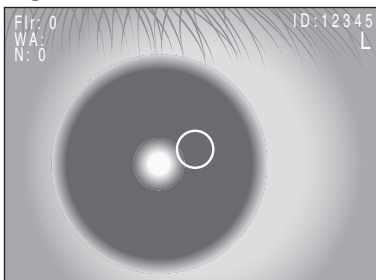

Perform the frontal view alignment while monitoring Frontal view alignment screen shown in the display.

- ① Frontal view of the patient's eye is shown in the display. Move Main unit until the luminous dot comes in the center of the display as shown in Fig. 3.

Fig. 4

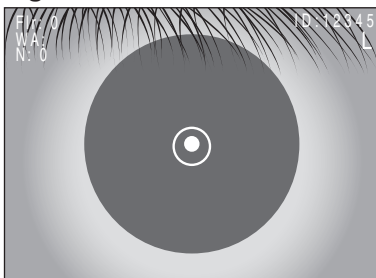

- ② As shown in Fig. 4, move the luminous dot into "○" mark and adjust the position of Main unit or Measurement unit to reduce the size of the luminous dot as small as possible. After all adjustments are completed, push "Measurement switch".

6. Procedure for measurements

6-4 Diagonal view alignment

Fig. 5

Perform the diagonal view alignment while monitoring Diagonal view alignment screen shown in the display.

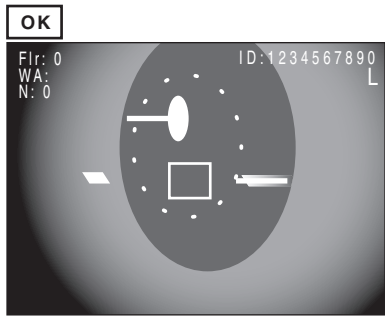

Diagonal view of the patient's eye is shown in the display. Laser beam is emitted and Measurement window is shown in the display. Use Joy stick to position Measurement window and Reflected lights as shown in Fig. 5 (OK) (see Fig.7).

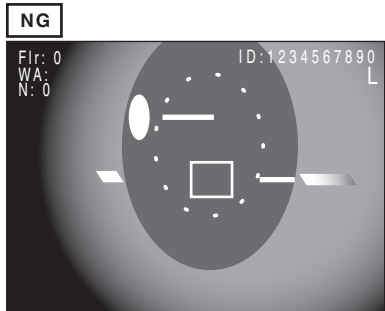

When the display shows their position as shown in this picture, laser beam is hitting the iris and background lights are not distributed evenly which would cause false measurements. See Fig. 6 and re-align.

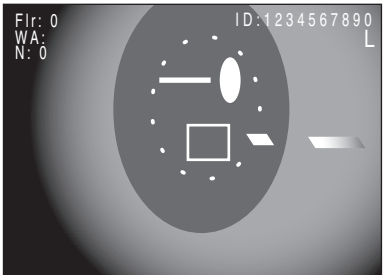

When the display shows their position as shown in this picture, there is no window between two laser beams and the Measurement point is placed far away from the anterior chamber which would cause false measurements. See Fig. 6 and re-align.

Points for alignment

1. Measurement window must be between the left and right laser beams.
2. Measurement window must be located below the Spot light.
3. Measurement window and the right laser beam must be within the pupil.

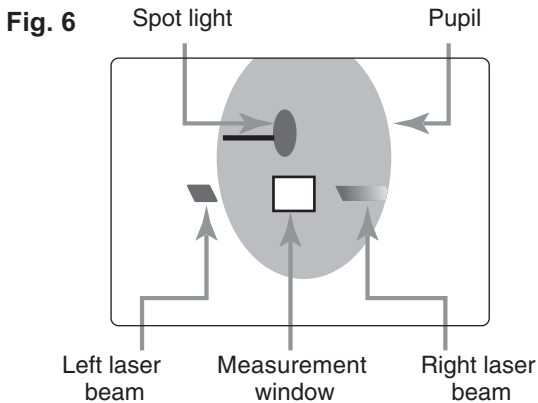

Points for operation

It is recommended to tilt the joy stick lightly in diagonal directions while monitoring Diagonal view alignment screen.

Fig. 7

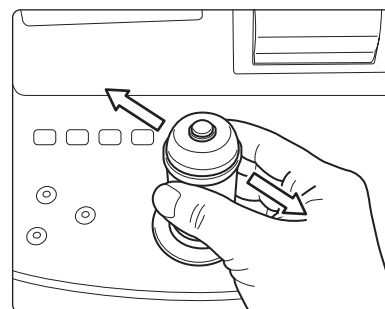

■ 6-5 BG check

Fig. 8

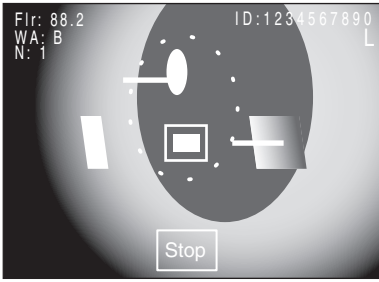

BG check starts when Diagonal view alignment screen is displayed.

BG level appears in Measurement window.

(Laser emission stops automatically when a certain period of time elapses. Pressing “Measurement switch” restarts the emission.)

Fig. 9

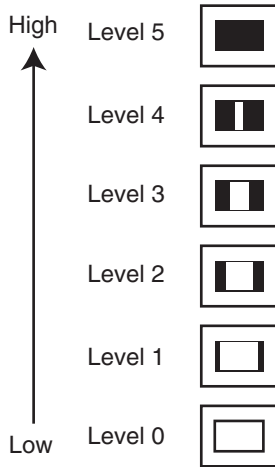

BG level indicator

BG check finds out the uniformity of background lights by determining the background lights around Measurement window. Level of the uniformity appears in Measurement window shown in the display. This is what we call “BG level indicator”. Details are shown in Figure 9.

Level 5 is the highest level that indicates background lights are distributed most evenly, while Level 0 is the worst level that indicates the worst uniformity.

You may proceed to the measurement when the color of BG level indicator turns to green.

You can not start the measurement when it is white.

BG level may be changed when the level does not become high. You may also force to start the measurement regardless of the level.

Refer to “8. Configuration and setting”.

However, measurements taken at a low BG level, reliability of them would be lowered.

■ 6-6 Measurement

Fig. 10

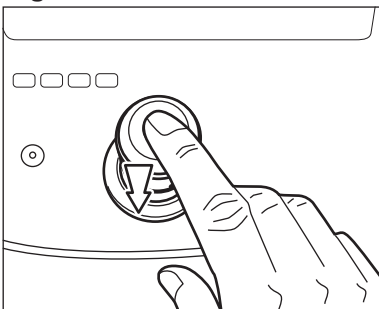

Press “Measurement switch” when the color of BG level indicator turns to green.

Measurement starts and completes in 0.5 second.

6. Procedure for measurements

6-7 Displaying measurement results

Fig. 11

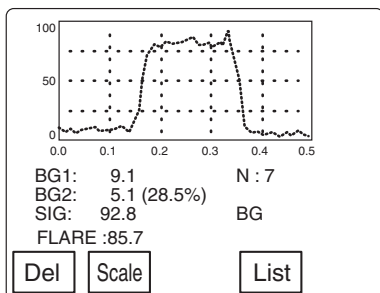

Results are presented in graphs and values in the display as shown in Fig. 11. Data is automatically saved per measurement (the automatic save function may be disabled).

● When it is not needed to save data

If you do not need data to be saved, select “Del”.
The vertical scale for graphs can be changed between 4 levels including “0 - 100”, “0 - 200”, “0 - 500” and “0 - 1000”, when “Scale” is selected.

Fig. 12

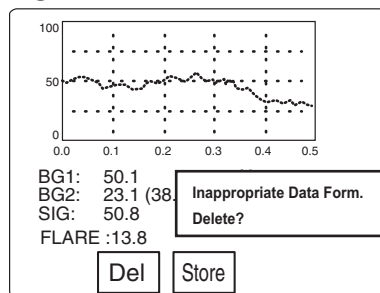

● Waveform evaluation

Flare is compared with $|BG1 - BG2|$ per measurement.
 $(SIG - BBG*) - |BG1 - BG2| > 0$ is acceptable and no message is displayed.
 $(SIG - BBG*) - |BG1 - BG2| \leq 0$ is unacceptable and the message “Inappropriate Data Form. Delete?” is displayed.
 Select “Del” to delete or “Store” to save.

* BBG is BG1 or BG2, whichever the larger.

Fig. 13

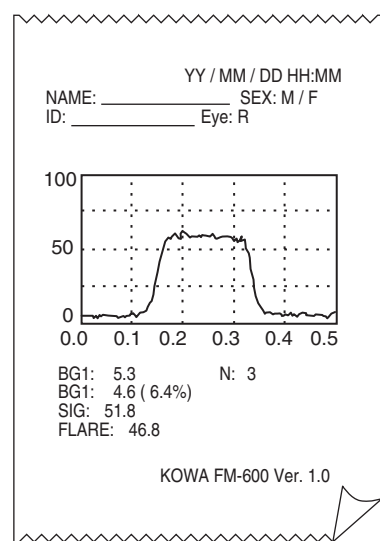

Print out sheet sample

● Printing out the display

Pressing “Print switch” prints out the display contents as seen in the print out sheet sample shown in Fig. 13.

● When continuously conducting multiple measurements

If you want to continue taking additional measurements, press “Measurement switch”. BG check screen appears and you may continue the measurement.

● Maximum number of data savings

When measurements are repeated on the same eye, up to 10 data savings are allowed.

● Switching the display to Summary data screen

When you want to have the display to show Summary data screen, select “List”.

6-8 Showing and editing acquired data

Fig. 14 Summary data screen

N	BG	(%)	FLARE	W/A
1	9.8	17	20	Test Result
2	8.5	6	22	No. of outliers : 1
3	8.0	9	21	After the Test.
4	8.3		55	No. of data : 4
5	9.0	8	19	AV.:20.5
			AV:	20.5
			SD:	1.1
S.D.:1.1				
Erase Outliers?				
		<input type="button" value="Yes"/> <input type="button" value="No"/>		

If you have selected “List” in the display shown in the previous step, Summary data screen appears which shows a summary listing an average flare value and standard deviation (Fig. 14).

At the same time an outlier test is performed.

● Outlier test of acquired data

When 5 or more data has been acquired, an outlier test is performed to find any outlier (or throw-out) candidate datum (see Additional Information below).

When the message “Erase Outliers?” appears, select “Yes” to delete or “No” to save. Selecting “Yes” deletes the candidate data and recalculates an average flare value (Fig. 15).

Fig. 15

N	BG	(%)	FLARE	W/A
1	9.8	17	20	BC
2	8.5	6	22	
3	8.0	9	21	
4	9.0	8	19	
			AV:	20.5
			SD:	1.1
<input type="button" value="Cont"/> <input type="button" value="Edit"/> <input type="button" value="Stat"/> <input type="button" value="End"/>				

Example:

Fig. 14 shows an example. When a significance level of 0.05 is selected and five flare values are 20, 22, 21, 55, then 19, 55 would be a candidate.

Additional Information:

- Outlier test requires at least five data. The required number of data may be changed to any number between 5 and 10 (see “8. Configuration and settings”).
- This outlier test uses Smirnov and Grubbs’ method and the significance level may be 0.001, 0.025, 0.05, 0.1, 0.15 or 0.2 (see “8. Configuration and settings” for details). The greater the significance level, the greater the number of throw-out candidate data would be detected.
- You may also select not to perform an outlier test (see “8. Configuration and settings”).
- When there is no candidate the message “The result No. of Outliers:0 No outliers” appears.

Fig. 16

N	BG	%	FLARE	W/A
1	9.8	17	20	BC
2	8.5	6	22	
3	8.0	9	21	
4	9.0	8	19	
			AV:	20.5
			SD:	1.1
<input type="button" value="↓"/> <input type="button" value="↑"/> <input type="button" value="Del"/> <input type="button" value="Set"/>				

● Editing summary data

When you want to delete some data from Summary data screen, select “Edit”.

Use “↓” and “↑” to select and highlight a datum.

When you select “Del”, two lines are placed over the datum (Fig. 16).

After you select all data you want to delete and select “Del”, the message “Delete the selected data?” appears.

Selecting “Yes” deletes all the data selected and exit the editing step.

Fig. 17

YY / MM / DD HH:MM				
NAME: _____		SEX: M / F		
ID: _____		Eye: R		
N	BG	(%)	FLARE	W/A
1	0.7	7.4	82.9	
2	0.9	23.0	77.6	B
3	0.9	55.6	81.8	B
			AV :	80.8
			SD :	2.8
KOWA FM-600 Ver. 1.0				

● Printing out the display

Pressing “Print switch” prints out Summary data screen contents as seen in the print out sheet sample shown in Fig. 17.

● Continuing / ending measurement

If you want to continue taking additional measurements, select “Cont” in Summary data screen.

Frontal view alignment screen appears (Maximum number of measurements is 10).

If you finish measurement of the current eye, select “End” in Summary data screen.

When the message “Proceed ? (Erase all data ?)” appears, select “OK” to delete all data and go back to Frontal view alignment screen.

Selecting “No” deletes no datum and takes you back to Frontal view alignment screen.

7. Tips for measurements

■ 7-1 How to block laser beams

Fig. 1

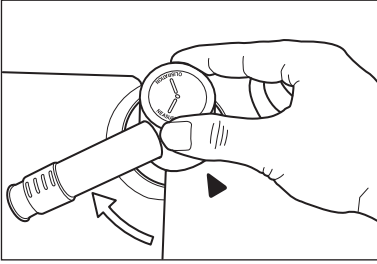

Turning Calibrator until it comes to the position shown in Fig. 1 makes a click-sound and blocks laser beams.

Use this method to block laser beams immediately and securely. The following message appears.

Laser Attenuating ...
If Measure / Calibrate
Set the position of Cali. Tool as follows.
Measure = Measurement
Calibrate = Calibration

When you start measuring, turn Calibrator counter-clockwise until it comes to MEASUREMENT.

When you start calibrating, turn Calibrator clockwise until it comes to CALIBRATION.

■ 7-2 Warning beep during BG check

Fig. 2

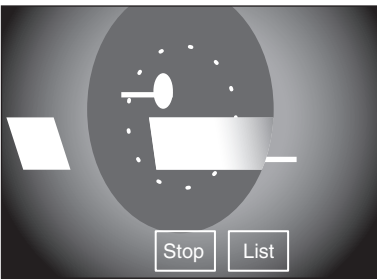

When intensive laser beam comes into Measuring window as shown in Fig. 2, Excessive light detector automatically emits a series of high-pitch short repeated alarm.

When you hear this alarm, move Main unit and Measurement unit away to keep excessive laser beam from entering into Measuring window.

Caution: Excessive laser beam may cause a photoreceiver element failure.

■ 7-3 Recommended procedures when BG check obtains no correct alignment

Fig. 3

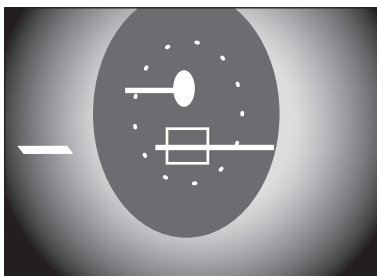

When Excessive light detector does not stop the alarm in BG check screen, press "Frontal view switch" to go back to Frontal view alignment screen or select "Stop" on Fig. 2.

Selecting "Stop" terminates the ongoing laser scanning and stops BG check. Realign while monitoring the laser beam position. In order to perform BG check again, press "Measurement switch" (Fig. 3).

■ 7-4 Recommended procedures when BG check obtains no good result

Fig. 4

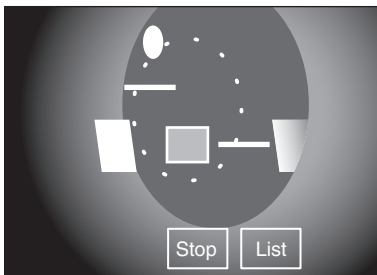

Reading on the eye. BG check may result in good without using the alignment mark (Fig. 4).

Important point is to align the device so that no iris image or reflected glare comes into Measurement window (see ■ 6-4 Diagonal view alignment).

■ 7-5 Recommended procedures when measured waveforms are offset to left or right

Fig. 6

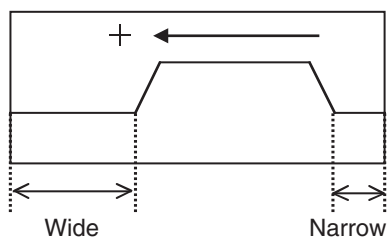

You may encounter waveform offset to the left as shown in Fig. 6 when attempting a measurement at an excessively lower part of the anterior chamber.

You can not obtain a correct flare value in this condition.

① Select "ON" for "Laser : Position" as described in "8. Configuration and settings" and change the laser position in BG check screen to solve this problem.

Fig. 7



② Use "+" and "-" several times to change the laser position.

③ Press "Measurement switch" to perform a measurement after the position change. This setting is effective until all measurement data for the one examined eye are cleared*.

* Select "End" in Summary data screen.

8.

Configuration and settings

Fig. 1

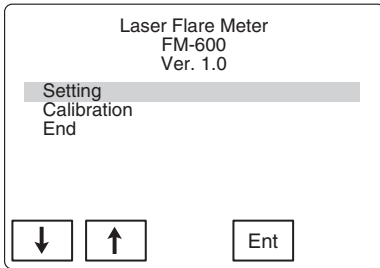

- ① Press and hold "Print switch" for more than 4 seconds to display the menu screen (Fig. 1).
- ② Select "Setting" using "↓" or "↑" and select "Ent" to display Setting menu screen.

Fig. 2

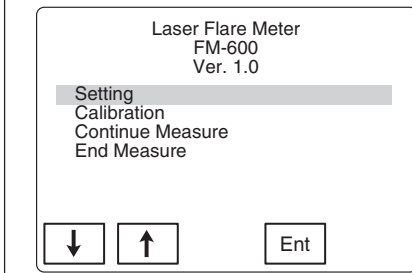

When collected data exists, contents of the menu would be as shown in Fig. 2.

Select "setting" using "↓" or "↑" then select "Ent" to display Setting menu screen. In order to end the setting and move to other screen, you must decide the next procedure. Use "↓" or "↑" to select an item and select "Ent".

Calibration	(to delete collected data and perform calibration)
Continue Measure	(to keep collected data and exit the menu screen)
End Measure	(to open Summary data screen)

Fig. 3

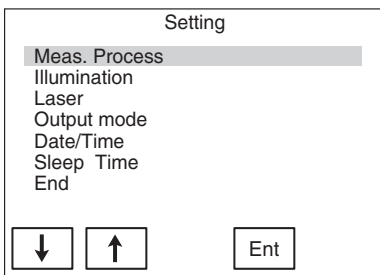

- ③ Use "↓" or "↑" to select an item from the screen shown in Fig. 3 and select "Ent" to open the menu screen corresponding to the selected item. Changing the mode of each item you may change the state of this device.

Details of each item are described below:

Meas. Process (common settings regarding measurement)

Setting menu	Description	Selection
BG Error Check	Prohibiting "Yes" or not prohibiting "No" a measurement with a quality below BG error level.	Yes / No
BG Error Level	BG error level setting, "H" for rigorous or "L" for reduced error level.	H / M / L
Meas. TRG	Auto or manual measurement after BG error check.	Auto / Manual
Alignment Mode	Diagonal view alignment, "1" for single step or "2" for double step.	1 / 2
Graph View	Displaying "On" or not displaying "Off" Graph View.	On / Off
ID No. Input	Allowing "On" or not allowing "Off" ID input.	On / Off
Graph Review	Displaying "On" or not displaying "Off" Graph View when, "Del" is selected to delete some data in Summary data screen.	On / Off
Data Store	Saving measurements automatically or manually.	Manual / Auto
Data Form Evaluation	Executing "On" or not executing "Off" a data shape evaluation.	On / Off
Auto Statistics	Automatic, significance level, and minimum number of data settings for outlier test.	Auto 5% 5

Shadowed items and numbers within brackets are default settings.

Illumination settings

Setting menu	Description	Selection
Front View	Illumination intensity settings of Frontal view alignment screen.	1 - 10
Side View	Illumination intensity settings of Diagonal alignment screen.	1 - 10
Chin Light	White LED illumination, "On" or "Off" .	On / Off
Monitor Bright	Monitor Brightness adjustment.	-63 - +64 (-40)
Monitor Contrast	Monitor Contrast adjustment.	-63 - +64 (-40)

Laser settings

Setting menu	Description	Selection
Position	Allowing "On" or not allowing "Off" to change laser scanning position temporarily.	On / Off
Default	Default setting of permanent laser scanning position.	-3 - +4 (0)
Off Time	Setting of a period of time elapsed before aborting laser emission.	01 - 10

Data output settings

Setting menu	Description	Selection
Output to	Selecting devices to which data are output. PRN : Printer only, EXT : External device only, PRN + EXT : Printer and external device.	PRN / EXT / PRN+EXT
Form	Selecting "On" or not selecting "Off" contents to be printed.	
Name	Patient name	On / Off
ID	Patient ID	On / Off
Sex	Patient sex	On / Off
Eye	Examined patient eye	On / Off
Data	Collected data	All / Result
Date	Date (time when data was acquired for Measurements graph screen and time when data was outputted for Summary data screen) .	On / Off
Equipment	Name of equipment	On / Off

Date/Time settings

Setting menu	Description	Selection
Date Form	Selecting "yy/mm/dd", "mm/dd/yy", or "dd/mm/yy".	YY / MM / DD
Date	Displaying the date when settings were made. Values may be changed using \leftrightarrow - +.	— — —
Time(24h)	Displaying the time (24h) when settings were made.	— — —

Sleep time settings

Setting menu	Description	Selection
Sleep Time	Time setting for power saving function to become active In order to terminate the power saving mode, press any key.	0 - 99 (10)

Shadowed items and numbers within brackets are default settings.

9. Miscellaneous

■ 9-1 ID input

In order to input an ID number, "ID No. Input" must be "On" (refer to "8. Configuration and settings"). Use function keys, ten keys, or a barcode reader to input an ID number.

Fig. 1

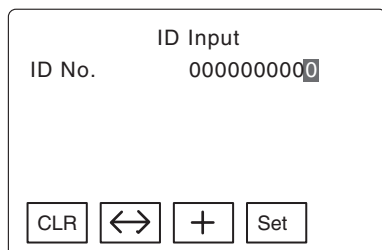

9-1-1 Inputting an ID number using function keys

- ① Select "CLR" to clear the number shown if any
- ② Use "↔" to move within the digits shown (selecting "↔" moves you to the left (the larger digit field next to the current one))
- ③ Use "+" to increase the number within the current field.
- ④ Use "Set" to confirm the input.

9-1-2 Inputting an ID number using function keys

You need a ten key pad with a PS/2 connector. This device accepts 0 to 9 and Enter key only. Any other key are not accepted. The primary field for a ten key pad is the right end field (other field you have selected using a function key will be ignored and you need to start from the right end field).

Function keys are active even when you have connected a ten key pad.

9-1-3 Inputting an ID number using a bar code reader

You need a bar code reader with a PS/2 connector. For details of configuration and settings of a bar code reader, refer to the users' manual supplied with your reader. Should you have any question, contact Kowa sales representative or dealership.

■ 9-2 Connecting external devices

When you use external device or software to acquire and control data, refer to the communication specifications and data structure.

⚠ Caution

- The RS232C cable must be less than 2 m.
- When you use a peripheral device and/or other device connected to the peripheral device must meet all applicable IEC standards.
- Data processing devices must meet IEC60601-1-1 or IEC60950.
The system that combines such data processing devices must meet IEC60601-1-1.
The system administrator who builds such system bears all responsibility to have the system comply with requirements of IEC60601-1-1.
Should you have any question, contact Kowa sales representative or dealership.

① Communication specifications

Baud rate	38400bps
Data	8bit
Parity	Even
Stop	1bit
Flow control	none

All data must be made of ASCII codes.
The double type is index display.

② Output data structure 1: Graph data

1. Data structure

Header	
Data	
Graph data	512
Footer	

2. Header

Name or data	Description	Data type
:LSS50	HEAD	Fixed
:LSS50	HEAD	Fixed
ID	ID No.	10digits, numeric
TempCorrect	Temperature compensation ON/OFF	0/1
CaliCorrect	Calibrator compensation ON/OFF	0/1
LD_TempCheck	LDTemp check ON/OFF	0/1
LD_AlarmCheck	LDAlarm check ON/OFF	0/1
asterisk	Calibration execution request OFF/ON	0/1
0	Data type (graph)	Fixed

3. Data

Name or data	Description	Data type
YY/MM/DD HH:MM	YY/MM/DD HH:MM	YY/MM/DD HH:MM
L/R	Examined eye (left or right)	0 = left, 1 = right
rank	BG rank during measurement	0 - 5
SN	Waring: S/N	0 = OK, -1 = NG
BG	Waring: BG	0 = OK, -1 = NG
CELL	Waring: CELL	0 = OK, -1 = NG
DF	Waring: D/F (data form evaluation)	0 = OK, -1 = NG
ST	Waring: ST (SG test results)	0 = OK, -1 = NG
DARK	DARK	Double type
BG1	BG1	Double type
BG2	BG2	Double type
Signal	SIG	Double type
Flare	FLARE	Double type
Sens	Sens	Double type
PMTTemp	PMTTemp	Double type

4. Graph data

Name or data	Description	Data type
fir_dt	Graph data	Short type

5. Footer

Name or data	Description	Data type
:END		Fixed

③ Output data structure 2: Summary data

1. Data structure

Header	
Data (common)	
Data (individual)	Repeated for as many data as collected
Footer transmission	

2. Header

Name or data	Description	Data type
:LSS50	HEAD	Fixed
:LSS50	HEAD	Fixed
ID	ID No.	10digits, numeric
TempCorrect	Temperature compensation ON/OFF	0/1
CaliCorrect	Calibrator compensation ON/OFF	0/1
LD_TempCheck	LDTemp check ON/OFF	0/1
LD_AlarmCheck	LDAlarm check ON/OFF	0/1
asterisk	Calibration execution request OFF/ON	0/1
1	Data type (list)	Fixed

3. Data (common)

Name or data	Description	Data type
YY/MM/DD HH:MM	YY/MM/DD HH:MM	YY/MM/DD HH:MM,
L/R	Examined eye (left or right)	0 = left, 1 = right
N	Number of data	1 - 10
AV.	Average	Double type
S.D.	S.D.	Double type

4. Data (individual)

Name or data	Description	Data type
Num	Data number	1 - 10
BG	BG average	Double type
BG_diff	BG amplitude (%)	Double type
Flare	FLARE evaluation result	Double type
Sens	Sens	Double type
PMTTemp	PMTTemp	Double type
Warning_SN	Waring: S/N	0 = OK, -1 = NG
Warning_BG	Waring: BG	0 = OK, -1 = NG
Warning_CELL	Waring: CELL	0 = OK, -1 = NG
Warning_DF	Waring: D/F(data form evaluation)	0 = OK, -1 = NG
Warning_ST	Waring: ST (SG test results)	0 = OK, -1 = NG

5. Send Footer

Name or data	Description	Data type
:END	End code	Fixed

9. Miscellaneous

■ 9-3 Display messages

This section explains the messages that appear in the screens.

Message	Description	Action
LD Temp Check Please wait	Temperature at the laser source is not within the specified range.	You need to wait until the temperature becomes appropriate.
Latest Calibration Data: (YY/MM/DD HH:mm) Calibrate Now?	One month has passed since last calibration. It is recommended to calibrate.	Selecting "Yes" starts calibration. Selecting "No" aborts calibration.
Laser Attenuating... If Measure / Calibrate Set the positions of Cali. Tool as follows. Measure : Measurement Calibrate : Calibration	Laser beam may attenuate depending on the calibrator position.	If you need no laser attenuation, turn the calibrator until it comes to MEASUREMENT or CALIBRATION.
ALERT Can't hold both R&L eye data. Keep on Measuring "L- eye". Or Erase all data.	While retaining the right (left) eye data, Measurement switch is pressed for the left (right) eye.	Select "End" on the summary table and proceed to the left (right) eye measurement.
Press the Joystick Button. To Return Scanning.	Time limit has passed over and laser emission is terminated automatically.	Pressing Measurement switch restarts laser emission.
Inappropriate Data Form Delete ?	Obtained waveform is not appropriate.	Selecting "Del" clears the data. Selecting "Store" saves the data.
Test Result No. of Outliers, After the Test. No. of Data, AV , S.D. Erase Outliers ?	Results of the outlier test are shown. Average and standard deviation is recalculated and displayed If any outlier datum is cleared.	Selecting "Yes" clears the candidate data. Selecting "No" does not clear them.
The result No. of Outliers: 0. No. Outliers.	Results of the outlier test presented no candidate data.	You need anything to do.
Display List Data. "Unstored Data " exists. Press "Graph " to store.	This message warns you about data that need to be saved.	By selecting "Graph" you can go back to Measurements graph screen where you save the data. Selecting "List" clears the unsaved data.
Clear Selected Data?	This message reminds you that the data selected on Summary screen will be cleared.	Selecting "Yes" clears the data. Selecting "No" does not clear the data.
PROCEED ? (Erase all data?)	This message reminds you that the data collected for the examined eye will be cleared before proceeding to next measurement.	Selecting "Yes" clears the data, completes a measurement, and displays Diagonal alignment screen.
Now transferring.	Data are now being transferred out from the device.	Wait until the data output completes.

■ 9-4 Function switches

Details of function switches are described in this section.

Function switch	Description	Function switch	Description
↑	Moves the cursor upwards.	List	Changes the current screen to Summary data screen.
↓	Moves the cursor downwards.	Scale	Changes the vertical scale for waveform graphs.
↔	Moves the cursor to the left or right.	Edit	Changes the current screen to Editing screen.
Ent	Confirms the selected setting or item.	ID	Changes the current screen to ID input screen.
Set	Confirms the setting.	CLR	Clear the number(s) shown in ID input fields.
End	Terminates the current setting screen.	Stat	Starts statistic processing.
+	Increases a parameter value.	Graph	Regenerates measurements graph from unsaved data.
-	Decreases a parameter value.	Cont	Performs additional measurement.
Yes	Accepts the setting.	Not. Cali	Performs no calibration.
No	Cancel the setting.		
Stop	Poses laser scanning.		
Store	Saves the measurement(s) shown.		
Del	Deletes the measurement(s) shown.		

■ 9-5 Relocation

Fig. 1

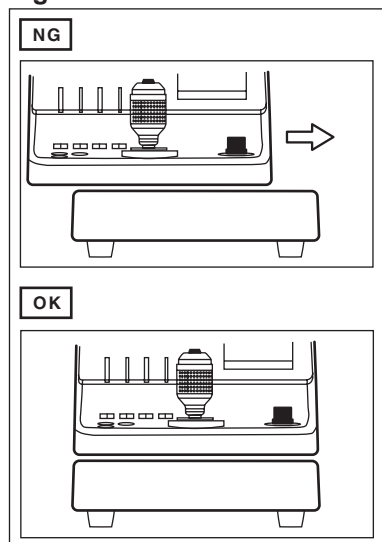

Follow the precautions shown below when you relocate this device:

- Move Main unit so that Main unit sits right on the top of Power Supply unit as shown in Fig. 1.
- Press down and tighten Self-locking screw clockwise as shown in Fig. 2.
- Place your both hands under the Power Supply unit and lift the device. Do not lift the device using any other part.
- Make sure there is no bump or dip on the place where you relocate the device.
- Make sure not to pinch your hands when placing the device in place.
- Turn counterclockwise and undo Self-locking screw after placing the device.

Fig. 2

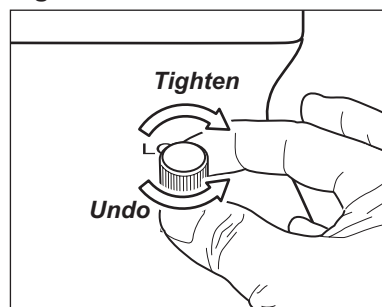
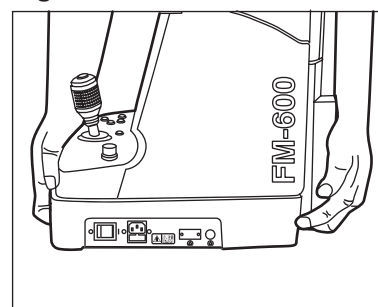

Fig. 3



10. Troubleshooting

10-1 Phenomena and validation

In this section, we discuss what you can do when you encounter a problem. When a problem occurs, check the items shown below first. If none of the items is the case or if the specified remedy solve your problem, please contact your Kowa dealer where you have purchased the instrument.

Situation	Phenomena	Validation (possible cause)	Remedy
Alignment	The display does not show the patient's eye (Frontal alignment screen).	Vertical level and the position of the eye are not aligned with those of the device.	Pull back Base segment and perform Ocular height adjustment again (see "6-2 Ocular height adjustment" on Page 19)ask the patient to sit in front of the device.
	The display does not show the patient's eye (Diagonal alignment screen).	The position of the eye not aligned with the device.	Align the position again using Frontal alignment screen.
	The display is whitened and the luminous dot for alignment does not appear.	No light shade is used in a well-lighted room.	Settings of the display are incorrect. Use a light shade. Adjust settings of the display correctly. Darken the room.
Measurement mode	No measurement is started (Measuring window does not turn to green).	The ratio of BG1 to BG2 is not good. "Yes" is selected for the setting of BG error check.	Change the target point. Change the settings: <ul style="list-style-type: none"> • Change the laser position. • Change BG level. • Select "No" for BG error check.
	No measurement is started (alarm is emitted).	Excessive light is detected blocking a measurement.	Change the target point.
	Data can not be saved.	Flare value is zero (0). "Store" button is not selected.	Perform measurement again.
Measurement data	BG value and BG% are too high.	The target point is not good. The room is well-lighted.	Change the target point. Darken the room or use a light shade.
	There are excessive variations in collected data.	The target point is not good.	Perform an additional measurement and perform a test.
Print	Nothing is printed out.	Any printer is not selected for Output mode.	Select "PRN" or "PRN + EXIT" for the output setting.
	Nothing is printed out.	No printer paper left.	Replace with a new printer paper roll.

10-2 Error messages

This section describes error messages that appear when a device malfunction occurs.

Message	Description	Remedy
Error1 DARK	DARK count exceeded the limit.	Turn off the power supply and contact Kowa sales representative.
Error2 PMT sens	Sensitivity of the photoreceiver element dropped below the limit.	Turn off the power supply and contact Kowa sales representative.
Error3 PMT Temp. Alarm	Temperature of the photoreceiver element exceeded the limit.	Turn off the power supply and contact Kowa sales representative.
Error4 LD Temp. Uncontrolled	Temperature of the laser source became uncontrollable.	Turn off the power supply and contact Kowa sales representative.
Error5 Printer Please Check Printer Paper	The printer paper roll or the lid is wrongly positioned (see Page 15).	If the problem continues, turn off the power supply and contact Kowa sales representative.
Error6 – 11	A system error occurred.	Turn off the power supply and contact Kowa sales representative.

11. Maintenance/Inspection

This instrument is a controlled medical device, of which the measurements obtained using this instrument may be affected by daily maintenance and inspection.

In order to use this instrument safely and correctly, carefully read the items listed in this section.

11-1 Daily maintenance

- ① Perform a calibration of this instrument a month in accordance with the procedure specified in "5. Calibration".
- ② Turn off POWER switch and place the dust cover on the instrument after use.
- ③ Make sure that the photoreceiver lens and the light emitting lens are not contaminated with dust, finger prints, and/or tear fluid. When they are contaminated wipe them clean first and re-clean using a soft gauze pad or sheets of lens cleaning paper dampened with 1:1 solution made of absolute alcohol and ether. Do not use any other agent or cloth.
- ④ Make sure that Eye fixation lamp window is not contaminated with dust, finger prints, and/or tear fluid. When it is contaminated, clean using sheets of lens cleaning paper dampened with neutral detergent solution. Do not use alcohol for cleaning.
- ⑤ When the main part of the device gets soiled, clean it with soft cloth. When the main part of the instrument gets soiled, clean it with soft cloth. Do not use chemicals or solvents such as thinner and benzene, which cause alteration, deformation, paint-loss.
- ⑥ If the instrument is not to be in use for a long period of time, turn OFF the Power switch and unplug the instrument.
- ⑦ When resuming use of instrument that has not been used for a long period of time, calibrate the instrument in accordance with the procedure specified in "5. Calibration".

11-2 Daily inspection (by the user)

Perform daily inspection in accordance with "FM-600 Daily Inspection Table".

When a problem is detected but can not solved with Daily maintenance procedure described above, contact Kowa or your Kowa dealer where you have purchased the instrument.

FM-600 Daily Inspection Table

Item	Inspection	Criteria
Power supply cable	Visually inspect that the power supply cable has no damage.	There is no damage.
Printer paper	Determine that an appropriate amount is left.	There is an appropriate amount is left.
Outer shell	Visually inspect that the main part does not have any crack or deformation.	There is no crack or deformation.
Rating plate, Pre-caution plate	Visually inspect that contents shown on the plates are readable.	Contents shown on the plates are readable.
Light emitting lens, photoreceiver lens	Visually inspect that the window surfaces on these lenses are not soiled.	The lenses are not contaminated with dust, finger prints, and/or tear fluid.
Chin-rest	Press Chin-rest ascending/descending switch and visually inspect that it operates properly.	Chin-rest ascends and descends properly.
Ascending and descending of Operating unit	Turn the joy stick and visually inspect that Operating unit ascends and descends properly.	Operating unit ascends and descends properly.
Calibration	Calibrate the device in accordance with the procedure specified in "5. Calibration".	Calibration successfully completes without any error.

11 Maintenance/Inspection

11-3 Fuse replacement

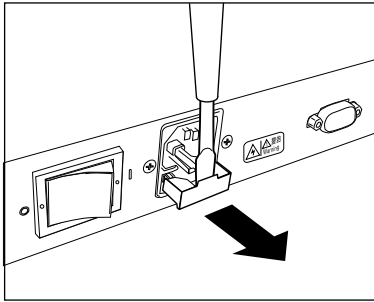

Turn the power switch OFF, unplug the power supply plug off from the power supply inlet and remove the fuse holder using a flat-head driver. Replace the blown fuse with a spare fuse. Use only a specified replacement fuse.

Manufacturer: Littelfuse

Part Name (Part #): 0218001M

Warning



Unplug

When replacing a fuse, be sure to turn OFF the Power switch and unplug instrument from the power outlet. Doing otherwise may result in electrical shock.



Warning/
High-Voltage

Use only a specified replacement fuse. Using other fuse may cause a device failure or fire.

11-4 Chin-rest paper installation

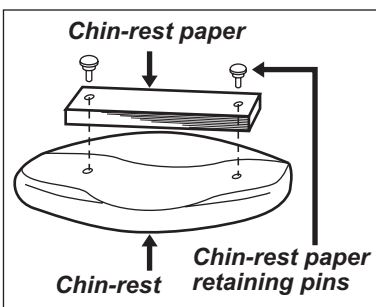

Place a sheet of Chin-rest paper on Chin-rest and hold the sheet with Chin-rest pins. Use a sheet of Chin-rest paper per patient and replace it with a new sheet for a next patient.

11-5 Sterilization of Forehead rest and Chin-rest

Forehead stopper must be wiped clean with alcohol disinfectant solution every time a patient finishes an examination with this instrument.

When you do not use a sheet of Chin-rest paper, Chin-rest must be wiped clean with alcohol disinfectant solution.

11-6 Refilling and replacing consumables

Item	Order Number
Chin-rest paper	K9L-TB45 #102
Chin-rest pins	K9L-TB45 #101
Printer paper	STH -148
Fuse	0218001M(T1.0A L250V)

Order any of the required consumables with the order number to your supplier.

11-7 Regular inspection (by the device supplier)

In order to use the device safely for a long period of time, it is recommended to have the following regular inspection done. For details of inspection and its const, consult with your supplier.

Items to be inspected 1.Outer shell, installation, 2. Optical components, 3. Operation and function of components, 4. Verification of laser power, 5. Calibration, 6. Verification of measuring functions.

11-8 Repairing

Contact. Your local Kowa Service representative.

12. Specifications

12-1 Specifications

Scanning laser source	Semiconductor laser, Wave length: 635nm, Intensity: 35±15μW
Photoreceiver element	A photomultiplier tube
Measurement range	1 - 500 Photon count/ms
Measurement accuracy	±5%(under the calibration environment)
Measurement area	0.3mm (H) X 0.5mm (W)
Measurement time	0.5 seconds
Measurement distance	81mm (Patient's eye - objective lens)
Printer	58mm - wide thermal printer
Monitor	5.6" TFT color LCD
Base segment movable range	Lengthwise: 37mm, Crosswise 89mm, Vertical: 25mm
Energy saving function	Provided
Interface	ID input: PS/2 * (a ten key pad and a bar code reader) Data output RS232C
Power supply	Input: AC100V - 230V, 50/60Hz, power consumption: 80VA (Normal), 100VA (Max)
Dimension/Weight	274(W) X 457(D) X 458(H)mm / 18 Kg

12-2 Completed safety standards and Classification

- IEC 60601-1:1988+A1:1991+A2:1995

Classification of the medical device according to on the protection type against electrical shock	Class I
Classification of the patient attachment according to on the protection level against electrical shock	Type B
Classification based on IEC60529: the level of protection that electrical appliances provide against the intrusion of water.	IPX0
Classification of safe use of the device based on the level of protection against the environment which contains air and flammable anesthesia gases, or the environment which contains oxygen or nitrous-oxide gas and flammable anesthesia gases	This is not a device capable of being used in such environment.
Classification of the device based on the operation mode	A device capable of being operated continuously

- IEC 60601-1-2:2001
- IEC 60825-1:2001 (Laser Class : Class 1)
- ISO 15004:1997

Complied EC Directive

Medical Device Directive 93/42/EEC
WEEE Directive 2002/96/EC

This device is a medical electrical instrument. The medical electrical instrument requires special care concerning electromagnetic compatibility (EMC). This section describes its suitability in terms of electromagnetic compatibility of this instrument. When installing or using this instrument, please read carefully and observe what is described here. (This instrument was tested on electromagnetic compatibility (EMC) based on IEC60601-1-2: 2001.)

1. Carefully handle portable- or mobile-type radio frequency communication unit (RF communications equipment) since it may have an adverse effect on this instrument resulting in malfunctioning.
2. Do not directly touch the pins of the connectors specified by the right figure. Also, take preventive measures before connecting cables to these connectors.

Examples of preventive measures are as follows;

- Pay attention to the humidity of the room (do not keep the humidity too low).
- Place the instrument where conductive floor is used.
- Wear non-polyester clothes.
- Discharge your body by touching a large metal or the metal part of the instrument chassis.
- Use a wrist strap against static electricity.



Also, provide guidance and training, in which warnings and precautions described above must be learned by all personnel who may use this device.

The subjects shown below may be used when providing such guidance and training.

[About Static Electricity]

All materials hold positive (+) and negative (-) electrical charges. Normally, the number of positive (+) charges is equal to the number of negative (-) charges. This is called "neutral" state.

However, when electrons are attracted by friction, contact or abrasion, the material holds more negative charges or more positive charges (this is called "electrically charged").

The electricity which is generated here is called "static electricity". Static electricity is generated anytime. However, electric charges where humidity is high leak quickly as water which is a conductor is attached to the surface of the material and the electricity passes through the water film.

By contrast, the material where humidity is low holds a few thousands of volts as it tends to remain electrically charged.

Static electricity which is built up is discharged through the earth via other conductors. This is called "electrostatic discharge".

When an operator with static electricity touches electronic devices or parts, they discharge static electricity, which may cause malfunction or damage.

Therefore, be very careful with electrostatic discharge when touching electronic devices or parts. Specific measures are as follows;

- Pay attention to the humidity of the room (do not keep the humidity too low).
- Place the instrument where conductive floor is used.
- Wear non-polyester clothes.
- Discharge your body by touching a large metal or the metal part of the instrument chassis.
- Use a wrist strap against static electricity.

These are preventive measures to avoid discharging static electricity through electronic devices or parts.

3. Do not use other than recommended options or accessories, since they may affect this device or other devices resulting in their malfunctioning.

power cable for 100V: KP300VCTFX5SQ KSA
 power cable for 200V: KP-4819Y KS-A
 RS-232C cross cable with sheath (a maximum length of 3 m)
 PC: A personal computer that carries CE mark, VCCI and FCC certificates.

4. This instrument is not designed such that it can be used adjacent to other instrument or placing one on top of another. Therefore, do not apply such use. Nevertheless, if such use is inevitable, it is necessary to constantly monitor if the instrument is functioning normally after such use has been adopted.

[Compliance verification and guidance]

Guidance and manufacturer's declaration - electromagnetic emissions		
The KOWA FM-600 is intended for use in the electromagnetic environment specified below. The customer or the user of the KOWA FM-600 should assure that it is used in such an environment.		
Emissions test	Compliance	Electromagnetic environment guidance
RF emissions CISPR 11	Group 1	The KOWA FM-600 uses RF energy only for its internal function. Therefore, its RF emissions are very low and are not likely to cause any interference in nearby electronic equipment.
RF emissions CISPR 11	Class A	The KOWA FM-600 is suitable for use in all establishments other than domestic and those directly connected to the public low-voltage power supply network that supplies buildings used for domestic purposes.
Harmonic emissions IEC 61000-3-2	Class A	
Voltage fluctuations/ flicker emissions IEC 61000-3-3	Complies	

Guidance and manufacturer's declaration - electromagnetic immunity			
The KOWA FM-600 is intended for use in the electromagnetic environment specified below. The customer or the user of the KOWA FM-600 should assure that it is used in such an environment.			
Immunity test	IEC 60601 test level	Compliance level	Electromagnetic environment - guidance
Electrostatic discharge (ESD) IEC 61000-4-2	± 6kV contact ± 8kV air	± 2, 4, 6kV contact ± 2, 4, 8kV air	Floors should be wood, concrete or ceramic tile. If floors are covered with synthetic material, the relative humidity should be at least 30%.
Electrical fast transient/burst IEC61000-4-4	± 2 kV for power supply lines ± 1 kV for input/output lines	± 2 kV for power supply lines ± 1 kV for input/output lines	Mains power quality should be that of a typical commercial or hospital environment.
Surge IEC 61000-4-5	± 1 kV differential mode ± 2 kV common mode	± 0.5,1 kV differential mode ± 0.5,1,2 kV common mode	Mains power quality should be that of a typical commercial or hospital environment.
Voltage dips, short interruptions and voltage variations on power supply input lines IEC61000-4-11	<5% U_T (>95% dip in U_T) for 0.5 cycle 40% U_T (60% dip in U_T) for 5 cycles 70% U_T (30% dip in U_T) for 25 cycles <5% U_T (>95% dip in U_T) for 5 sec	<5% U_T (>95% dip in U_T) for 0.5 cycle 40% U_T (60% dip in U_T) for 5 cycles 70% U_T (30% dip in U_T) for 25 cycles <5% U_T (>95% dip in U_T) for 5 sec	Mains power quality should be that of a typical commercial or hospital environment. If the user of the KOWA FM-600 requires continued operation during power mains interruptions, it is recommended that the KOWA FM-600 be powered from an uninterruptible power supply or a battery.
Power frequency (50/60Hz) Magnetic field IEC61000-4-8	3 A/m	3 A/m	Power frequency magnetic fields should be at levels characteristic of a typical location in a typical commercial or hospital environment.
NOTE U_T is the A.C. mains voltage prior to application of the test level.			

13. Electromagnetic Compatibility



Guidance and manufacturer's declaration - electromagnetic immunity

The KOWA FM-600 is intended for use in the electromagnetic environment specified below. The customer or the user of the KOWA FM-600 should assure that it is used in such an environment.

Immunity test	IEC 60601 test level	Compliance level	Electromagnetic environment - guidance
Conducted RF IEC 61000-4-6	3 Vrms 150 kHz to 80 MHz	3 V	Portable and mobile RF communications equipment should be used no closer to any part of the KOWA FM-600, including cables, than the recommended separation distance calculated from the equation applicable to the frequency of the transmitter. Recommended separation distance $d=1.2 \sqrt{P}$ $d=1.2 \sqrt{P}$ 80 MHz to 800 MHz $d=2.3 \sqrt{P}$ 800 MHz to 2.5 GHz where P is the maximum output power rating of the transmitter in watts (W) according to the transmitter manufacturer and d is the recommended separation distance in meters (m). Field strengths from fixed RF transmitters, as determined by an electromagnetic site survey ^a , should be less than the compliance level in each frequency range ^b . Interference may occur in the vicinity of equipment marked with the following symbol: 
Radiated RF IEC 61000-4-3	3 V/m 80 MHz to 2.5 GHz	3 V/m	

NOTE 1 At 80MHz and 800MHz, the higher frequency range applies.

NOTE 2 These guidelines may not apply in all situations. Electromagnetic propagation is affected by absorption and reflection from structures, objects and people.

- a Field strengths from fixed transmitters, such as base stations for radio (cellular/cordless) telephones and land mobile radios, amateur radio, AM and FM radio broadcast and TV broadcast cannot be predicted theoretically with accuracy. To assess the electromagnetic environment due to fixed RF transmitters, an electromagnetic site survey should be considered. If the measured field strength in the location in which the KOWA FM-600 is used exceeds the applicable RF compliance level above, the KOWA FM-600 should be observed to verify normal operation. If abnormal performance is observed, additional measures may be necessary, such as reorienting or relocating the KOWA FM-600.
- b Over the frequency range 150kHz to 80MHz, field strengths should be less than 3 V/m.

Recommended separation distances between portable and mobile RF communications equipment and the KOWA FM-600

The KOWA FM-600 is intended for use in an electromagnetic environment in which radiated RF disturbances are controlled. The customer or the user of the KOWA FM-600 can help prevent electromagnetic interference by maintaining a minimum distance between portable and mobile RF communications equipment (transmitters) and the KOWA FM-600 as recommended below, according to the maximum output power of the communications equipment.

Rated maximum output power of transmitter W	Separation distance according to frequency of transmitter m		
	150 kHz to 80 MHz $D=1.2 \sqrt{P}$	80 MHz to 800 MHz $d=1.2 \sqrt{P}$	800 MHz to 2.5 GHz $d=2.3 \sqrt{P}$
0.01	0.12	0.12	0.23
0.1	0.37	0.37	0.74
1	1.2	1.2	2.3
10	3.7	3.7	7.4
100	12	12	23

For transmitters rated at a maximum output power not listed above, the recommended separation distance d in meters (m) can be estimated using the equation applicable to the frequency of the transmitter, where P is the maximum output power rating of the transmitter in watts (W) according to the transmitter manufacturer.

NOTE 1 80MHz and 800MHz, the separation distance for the higher frequency range applies.

NOTE 2 These guidelines may not apply in all situations. Electromagnetic propagation is affected by absorption and reflection from structures, objects and people.

- The relative spectral output of the instrument

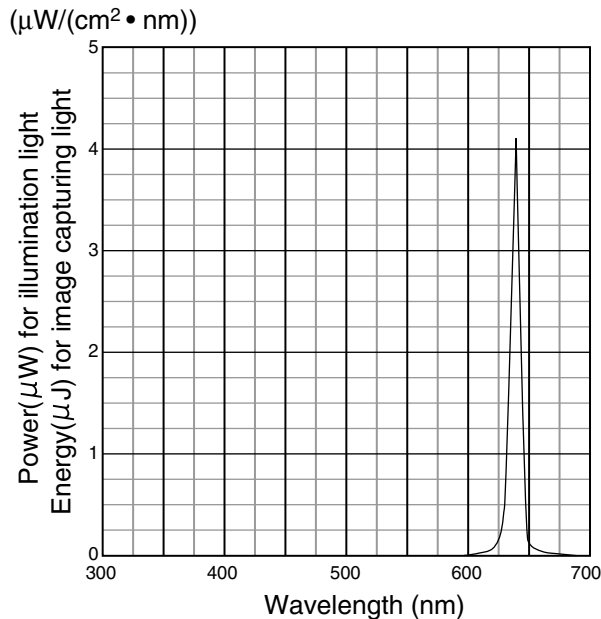

- The spectrally-weighted photochemical source radiance, both aphakic LB and aphakic LA

$$\text{LB} = 0.0352 \text{ mW}/(\text{cm}^2 \cdot \text{sr}) \text{ 305nm to 700nm}$$

$$\text{LA} = 0.0352 \text{ mW}/(\text{cm}^2 \cdot \text{sr}) \text{ 305nm to 700nm}$$

(informative)

Spectrally weighted photochemical radiances LB and LA give a measure of the potential that exists of a beam of light to cause photochemical hazard to the retina. LB gives the measure for eyes in which the crystalline lens is in place. LA gives this measure either for eyes in which the crystalline lens has been removed (aphakes) and has not been replaced by a UV-blocking lens or for the eyes of very young children.

The value stated for this ophthalmic instrument gives a measure of hazard potential when the instrument is operated at maximum intensity and maximum aperture. Values of LB or LA over $80 \text{ mW}/(\text{cm}^2 \cdot \text{sr})$ are considered high for beams which wholly fill a dilated pupil.

The retinal exposure dose for a photochemical hazard is a product of the radiance and the exposure time. For instance, at a radiance level of $80 \text{ mW}/(\text{cm}^2 \cdot \text{sr})$, 3 min irradiation of the dilated (8mm diameter) pupil would cause the retinal exposure dose level to attain the recommended exposure limit. If the value of radiance were reduced to $40 \text{ mW}/(\text{cm}^2 \cdot \text{sr})$, twice that time (i.e.6min) would be needed to reach the recommended limit. The recommended exposure dose is based on calculations arising from the American Conference of Governmental Industrial Hygienists (ACGIH) - Threshold Limit Values for Chemical Substances and Physical Agents (1995-1996 edition).

While no acute optical radiation hazards have been identified for ophthalmic instruments, it is recommended that the intensity of light directed into the subject's eye be limited to the minimum level which is necessary for diagnosis.

Infants, aphakes and persons with diseased eyes will be at greater risk. The risk may also be increased if the person being examined has had any exposure with the same instrument or any other ophthalmic instrument using a visible light source during the previous 24 h. This will apply particularly if the eye has been exposed to retinal photography.



Likvidace tohoto výrobku

Likvidace tohoto výrobku musí být podle zákona provedena ekologicky a výrobek je třeba individuálně soustředit na sběrných místech. Při likvidaci tohoto výrobku postupujte podle pokynů na následující webové stránce. Nemůžete-li tuto webovou stránku použít, obraťte se na prodejce.

URL: <http://www.kowa-europe.com/>

Bortskaffelse af dette produkt

Miljørigtig bortskaffelse er angivet ved lov for dette produkt, og det skal bortskaffes særskilt. Bortskaffelse af dette produkt skal foregå i overensstemmelse med proceduren på følgende webside. Hvis du ikke kan finde det på websiden, skal du kontakte din forhandler.

URL: <http://www.kowa-europe.com/>

Procedure voor opruimen van dit product

Dit product dient volgens een wettelijke bepaling op een milieuvriendelijke manier te worden opgeruimd en dient afzonderlijk voor opruimen opgehaald te worden. Ruim dit product op overeenkomstig de procedure door de volgende website te raadplegen.

Als u de website niet kunt raadplegen, contact opnemen met uw dealer.

URL: <http://www.kowa-europe.com/>

Disposal procedure for this product

An environmentally-friendly disposal method is specified by law for this product and it must be collected individually for disposal. Please discard this product in accordance with the procedure referred to in the following website.

If you cannot access the website, please contact your dealer.

URL: <http://www.kowa-europe.com/>

Toote äraviskamise eeskirjad

Seadusega on ette nähtud keskkonna sõbralik meetod selle toote jaoks ja seda peab väljaviskamise jaoks eraldi korjama. Palun visake see toode ära vastavalt protseduurile mis on kirjeldatud alljärgnevas veebsaidis. Kui Te ei saa kätte veebsaiti, palun võtke ühendust oma diileriga.

URL: <http://www.kowa-europe.com/>

Tuotteen hävittämistapa

Laki määrittelee, että tämä tuote on hävitettävä ympäristöystävällisellä tavalla ja että se on toimitettava erikseen hävitettäväksi. Hävittäkää tämä tuote seuraavassa sivustossa kuvatulla tavalla. Jos ette voi käyttää sivustoa, ottakaa yhteys jälleenmyyjään.

URL: <http://www.kowa-europe.com/>

Procédures d'élimination de cet appareil

La loi prescrit comment vous débarrasser de cet appareil dans le respect de l'environnement en recourant à la collecte sélective individuelle. Veuillez vous débarrasser de cet appareil en procédant de la façon indiquée sur le site Web.

Si vous ne pouvez pas consulter le site Web, adressez-vous à votre revendeur.

URL: <http://www.kowa-europe.com/>

Entsorgung des Produkts

Das Gesetz schreibt die umweltverträgliche Entsorgung dieses Produkts vor. Es darf nicht in den normalen Haushaltsmüll gegeben werden. Bitte entsorgen Sie das Produkt entsprechend den Hinweisen auf dieser Website. Falls Sie diese Website nicht besuchen können, wenden Sie sich bitte an Ihren zuständigen Fachhändler.

URL: <http://www.kowa-europe.com/>

Διαδικασία απόρριψης του παρόντος προϊόντος

Η φιλική προς το περιβάλλον μέθοδος απόρριψης καθορίζεται από το νόμο για το παρόν προϊόν το οποίο πρέπει να συλλέγεται μεμονωμένα για την απόρριψη. Απορρίψτε το παρόν προϊόν σύμφωνα με τη διαδικασία που αναφέρεται στον παρακάτω ιστοχώρο.

Εάν δεν μπορείτε να κάνετε αναφορά τον ιστοχώρο, επικοινωνήστε με τον αντιπρόσωπο.

URL: <http://www.kowa-europe.com/>

Termék-elhelyezési munkafolyamat

Egy – a törvény által előírt - környezetbarát lerakási módszer létezik erre a termékre, melyet egyesével kell összegyűjteni. Kérjük az ezen a honlapon található folyamat alapján selejtezzé ki ezt a terméket. Ha nem tudja elérni a honlapot, kérjük keresse fel a termékgalmazót.

URL: <http://www.kowa-europe.com/>

Per lo smaltimento di questo prodotto

Un metodo di smaltimento corretto per la salvaguardia dell'ambiente è specificato per legge e il prodotto deve essere raccolto in modo differenziato. A fine uso, disfarsi del prodotto seguendo la procedura indicata nel sito web seguente. Senza accesso al sito web, rivolgersi al proprio rivenditore di fiducia.

URL: <http://www.kowa-europe.com/>

Šim izstrādājumam paredzētā iznīcināšanas procedūra

Vīdei draudzīgo šī produkta iznīcināšanas procedūru nosaka likumdošana, un tam nepieciešama atsevišķa, iznīcināšanai paredzēta, savākšana. Lūdzu, izmetiet šo produktu atbilstoši šajā interneta lapā norādītajai procedūrai. Ja Jūs nevarat piekļūt šai interneta lapai, lūdzu, sazinieties ar savu dīleri.

URL: <http://www.kowa-europe.com/>

Šio gaminio išmetimo procedūra

Nežalingą aplinkai šio gaminio išmetimo būdą apibrėžia įstatymas ir išmetimui jį reikia išvežti atskirai. Šį gaminį išmeskite pagal šioje svetainėje nurodytą procedūrą. Jeigu negalite pasinaudoti šia svetaine, prašome susisiekti su savo prekybos agentu.

URL: <http://www.kowa-europe.com/>

Procedura ta' rimi għal dan il-prodott

Metodu ta' rimi li ma jagħmilx hsara lill-ambjent huwa specificat bil-liġi għal dan il-prodott u dan għandu jingabar individwalment biex jintrema'. Armi dan il-prodott skond il-procedura riferita fil-websajt li ġejja. Jekk ma tistax tftitx fil-websajt, jekk jogħġbok ikkuntattja lin-negozjant li minn għandu xtrajtju.

URL: <http://www.kowa-europe.com/>

Procedura utylizacji produktu

Odpowiednią, przyjazną dla środowiska metodę utylizacji tego produktu określają przepisy prawne. Produkt należy utylizować zgodnie z procedurą podaną w poniższym serwisie WWW. Jeżeli skorzystanie z podanego serwisu WWW nie jest możliwe, prosimy o kontakt z lokalnym przedstawicielem.

URL: <http://www.kowa-europe.com/>

Procedimento de eliminação para este produto

O método de eliminação sem prejudicar o meio ambiente é especificado pela lei aplicável a este produto e este deve ser eliminado individualmente. Elimine este produto de acordo com o procedimento referido no seguinte website. Caso não consulte o website, contacte o seu vendedor.

URL: <http://www.kowa-europe.com/>

Postup odstránenia tohto výrobku do odpadu

Zákonem je pre tento výrobok stanovený spôsob odstránenia do odpadu tak, aby nedošlo k poškodeniu životného prostredia a preto sa musí individuálne zbierať do odpadu. Odstráňte prosím tento výrobok do odpadu podľa postupu, ktorý je uvedený na nasledovnej webovej stránke. Ak nemáte prístup k tejto webovej stránke, skontaktujte sa prosím s predajcom.

URL: <http://www.kowa-europe.com/>

Postopek odstranitve za ta izdelek

Okolju prijazen postopek odstranjevanja je določen z zakonom za ta izdelek in mora biti zbran individualno za odstranitev. Prosimo, odvrzite ta izdelek ustrezno s postopkom, ki je opisan na sledeči spletni strani. V kolikor nimate dostopa do spletne strani, prosimo, da se obrnete na vašega trgovca.

URL: <http://www.kowa-europe.com/>

Procedimiento para desechar este producto

La ley prevé un método ecológico específico para desechar este producto, el cual debe recogerse en forma individual para su descarte. Respete este procedimiento, de acuerdo con el siguiente sitio Web. Si no puede consultar el sitio Web, contacte con el distribuidor.

URL: <http://www.kowa-europe.com/>

Procedur för att kasta bort denna produkt

Miljövänliga källsorteringsmetoder ska enligt lag användas för denna produkt och delarna måste sorteras individuellt innan de kastas bort. Vänligen gör dig av med denna produkt i enlighet med proceduren som beskrivs på följande webbplats. Om du inte kan nå webbplatsen, ska du kontakta din återförsäljare.

URL: <http://www.kowa-europe.com/>



Kowa Company, Ltd.

(World Sales Headquarters)

4-14, Nihonbashi-honcho 3-chome, Chuo-ku, Tokyo 103-8433 Japan

Phone: 81(3) 3279-7331

Facsimile: 81(3) 5255-7516



Kowa Company, Ltd. Hamamatsu Factory

3-1, Shinmiyakoda 1-chome, Hamamatsu city, Shizuoka Pref., 431-2103 Japan

Printed on recycled paper.



Kowa Europe GmbH

Immermannstrasse 43B

40210 Duesseldorf F.R. Germany

Phone: 49(211) 1793540

Facsimile: 49(211) 161952

© 2006 Kowa Company, Ltd. All rights reserved.

LSS50 V1.0 E 061208 MS

Printed in Japan