



KeysFitness®

A4t

Owner's Manual

Alliance A4t Treadmill

Customer Service

(888) 340-0482

Keys Fitness Products

4009 Distribution Drive
Suite 250
Garland, TX 75041

www.keysfitness.com



CAUTION! Read all precautions and instructions in this manual before using this equipment.

Model Name : A4t

Serial Number :

Write down for future reference

Serial Number Decal Location

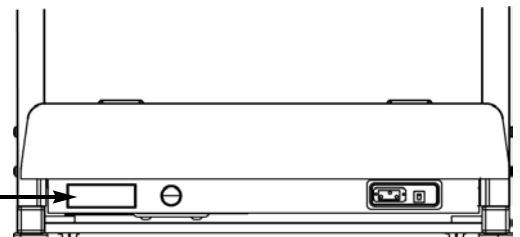

15-0168
1/05 Rev. B

Table of Contents



Important Safety Information	3
Before You Start	4
Assembly	5
Moving Instructions	6
Power Requirements	7
Console Panel Functions	8
Program Operation	9-10
Program Profiles	11
Warm Up Exercises	12
Changing to MPH or KM	13
Calibration Sequence	14
Belt Adjustment	15
Maintenance Instructions	16
Error Messages	17
Troubleshooting	18
Parts List	19
Exploded View	20
Warranty Information	21

Important Safety Information



WARNING! Before using this treadmill or starting any exercise program, consult your physician. This is especially important for persons over the age of 35 and/or persons with pre-existing health problems. The manufacturer or distributor assumes no responsibility for personal injury or property damage sustained by or through the use of this product.

WARNING! To reduce the risk of electrical shock, burns, fire, or other possible injuries to the user, it is important to review this manual and the following precautions **before** operation.

SAFETY PRECAUTIONS AND TIPS

1. It is the owner's responsibility to ensure that all users of this treadmill have read the Owner's Manual and are familiar with warnings and safety precautions.
2. This treadmill has a user maximum capacity of **300** pounds.
3. The treadmill should only be used on a level surface and is intended for indoor use only. The treadmill should not be placed in a garage, patio, or near water and should never be used while you are wet. Keys Fitness recommends a treadmill mat be placed under the treadmill to protect floor or carpet and for easier cleaning.
4. Follow safety information in regards to plugging in your treadmill. Keep the power cord away from the incline wheels and do not run the power cord underneath your treadmill. Do not operate the treadmill with a damaged or frayed power cord.
5. Wear comfortable, good-quality walking or running shoes and appropriate clothing. Do not use the treadmill with bare feet, sandals, socks or stockings.
6. Always straddle the belt and allow it to start moving before stepping onto the belt.
7. Hold on to handrail when adjusting speed, incline, or other controls.
8. Always examine your treadmill before using to ensure all parts are in working order.
9. Allow the belt to fully stop before dismounting.
10. Pets should never be allowed near or on the treadmill.
11. Do not leave children unsupervised near or on the treadmill.
12. Never operate the treadmill where oxygen is being administered, or where aerosol products are being used.
13. Never insert any object or body parts into any opening.
14. For safety and to prevent damage to your treadmill, no more than one person should use the treadmill at a time.
15. Always unplug the treadmill before cleaning and/or servicing. Service to your treadmill should only be performed by an authorized service representative, unless authorized and/or instructed by the manufacturer.
16. Failure to follow these instructions will void the treadmill warranty.
17. Never leave the treadmill unattended while it is running.

Before You Start

Thank you for purchasing the **Alliance A4t Treadmill**! This quality product you have chosen was designed to meet your needs for cardiovascular exercise. Before you start, please read the Owner's Manual and become familiar with the operation of your new treadmill.

Remember to take the time to perform the stretching exercises provided to avoid injury.

Do not stand on the walking belt while pressing the Power button or Start/Stop button.

Always adjust the speed of the treadmill in small increments as this treadmill is capable of high speeds.

If you are taking medication, consult your physician to see if the medication will affect your exercise heart rate.

If you have heart problems, you are not active, and/or are over the age of 35 years, do not use the pre-set treadmill programs or start an exercise program without first contacting and receiving approval from your physician.

To avoid the risk of electrical shock, always keep the console dry. Do not spill liquids on the console. Keys Fitness recommends a sealed water bottle for beverages consumed while using the treadmill.

Please review the following drawing below to familiarize yourself with the listed parts. This manual covers several treadmills, so the one pictured below may not be identical to your particular model.

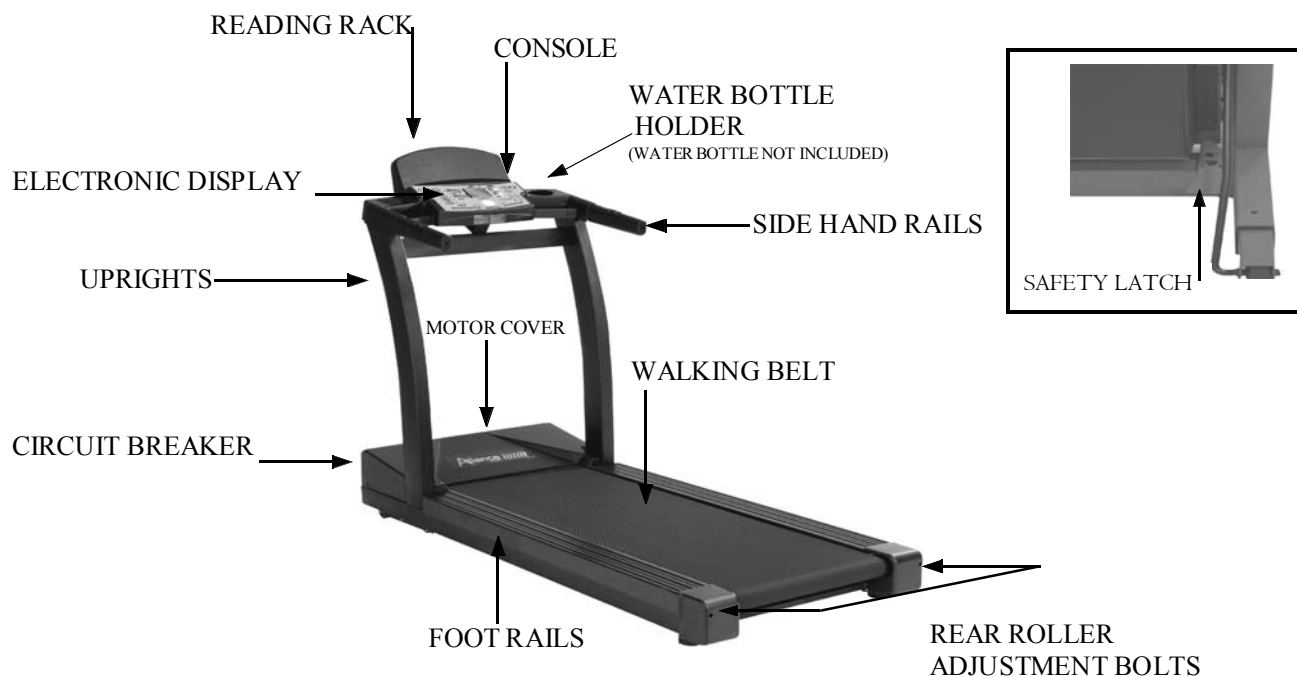

This **A4t Treadmill** is shipped in one piece and fully assembled. After opening the box, remove any packing material from the treadmill.

Do not throw away any packing materials until the unit is working properly.

Place the base on a clean, level surface. Make sure the electrical cord will easily reach an electrical outlet.

Remove the protective plastic coatings from all decals.

Locate the hardware pack and identify the following parts.

Insert Pack:

Safety Key

Allen Wrench 3/16" * 6"

Owner's Manual

Moving Instructions

Moving

CAUTION! TO AVOID THE RISK OF INJURY, NEVER ATTEMPT TO MOVE THE TREADMILL WHILE IT IS IN THE UNFOLDED OPERATING POSITION. TO REDUCE THE POSSIBILITY OF INJURY WHILE LIFTING, BEND YOUR LEGS AND KEEP YOUR BACK STRAIGHT. AS YOU RAISE THE TREADMILL, LIFT USING YOUR LEGS, NOT YOUR BACK. IN ORDER TO RAISE OR LOWER THE TREADMILL SAFELY, YOU MUST BE ABLE TO LIFT 45 POUNDS (20KG). IT IS SUGGESTED YOU ALWAYS USE THE AID OF A SECOND PERSON WHEN MOVING THE TREADMILL.

With the treadmill in the folded locked position (safety latch is engaged), grasp the handrails and place one foot on the base as shown in the photo below. Next, with a firm grasp on handrails, place one foot on the center of the base crossbar and carefully tilt the treadmill back until it rolls freely on the wheels. Using extreme caution, move the treadmill to the desired location. To set the treadmill down, place one foot on the center of the base crossbar and carefully lower treadmill onto base in resting position. Do not attempt to move the treadmill over an uneven or rough surface.



Power Requirements

IMPROPER CONNECTION OF THE EQUIPMENT GROUNDING CONNECTOR CAN RESULT IN A RISK OF AN ELECTRIC SHOCK. CHECK WITH A QUALIFIED ELECTRICIAN OR SERVICE MAN IF YOU ARE IN DOUBT AS TO WHETHER THE PRODUCT IS PROPERLY GROUNDED. DO NOT MODIFY THE PLUG PROVIDED WITH THE PRODUCT. IF PLUG WILL NOT FIT THE OUTLET, HAVE A PROPER OUTLET INSTALLED BY A QUALIFIED ELECTRICIAN.

This treadmill can be seriously damaged by sudden voltage changes in your home's electrical power. Voltage spikes, surges, and noise interference can result from weather conditions or from other appliances being turned on or off. To reduce the possibility of treadmill damage, always use a dedicated **surge protector** (not included) with your treadmill.

Surge protectors can be purchased at most hardware stores. The manufacturer recommends a single outlet surge protector with UL 1449 rating as a Transient Voltage Surge Suppressor (TVSS) with UL suppressed voltage rating of 400V or less and an electrical rating of 120VAC, 15 amps.

This treadmill must be grounded to reduce the risk of electrical shock. Grounding provides a path of least resistance for electric current should the treadmill malfunction. This treadmill comes with an electrical cord with an equipment-grounding conductor and a grounding plug. Always plug the power cord into a surge protector, and plug the surge protector into an appropriate outlet that is properly installed and grounded in accordance with all local codes and ordinances. Do not connect other equipment to the surge protector or this could cause permanent damage to your treadmill.

This product is for use on a nominal 120-volt circuit and has a grounding plug that looks like the plug illustrated in the drawing below.

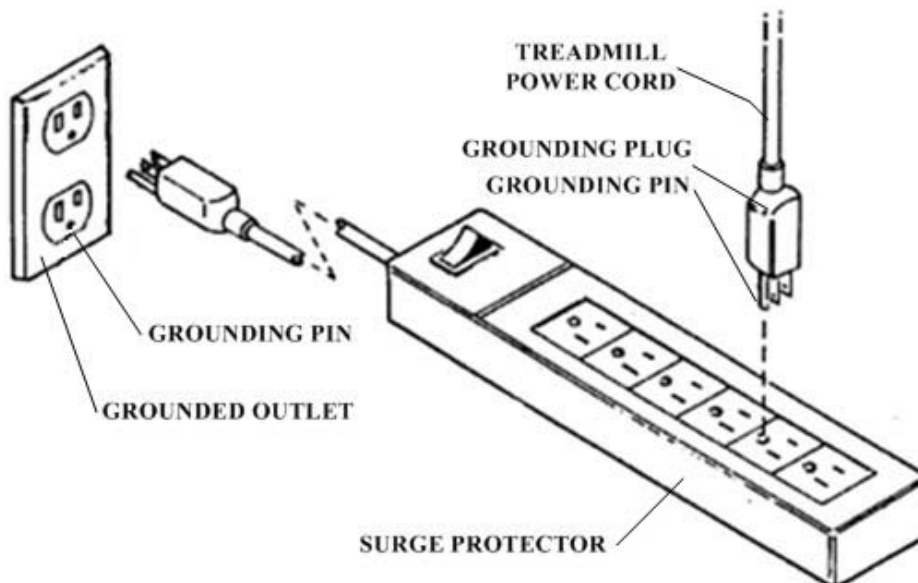

Console Panel Functions

There are five display windows on the control panel to provide feedback information.

TIME WINDOW

- ◆TIME: Indicates elapsed time after pressing start in minutes and seconds (0-99 minutes, 0-59 seconds)
- ◆INTERVAL TIME: Indicates countdown in seconds to the next interval starting at 5 seconds and counting to 0 seconds

SPEED WINDOW

- ◆SPEED: Indicates MPH (miles per hour) or KMH (kilometer per hour) in .1 increments

CALORIES / DISTANCE WINDOW

- ◆DISTANCE: Indicates Miles or Kilometers traveled in .01 increments up to 9.99 and .1 increments starting at 10.0
- ◆CALORIES: Indicates estimated calories used based on 150 lb. person at the indicated speed, incline, and time

INCLINE WINDOW

- ◆INCLINE: Indicates incline in percent of grade 0-12% in 0.5 increments

CENTER BRICKYARD WINDOW

- ◆Displays quarter mile track in Manual mode. Indicates position on track by a blink. In program mode, shows the change in speed profile across the interval range (1-10) and shows position with a blinking action.
- ◆In Program mode, the treadmill will display the name of the program selected. This is shown on the left hand side of the window. In Manual mode, the LAP counter will appear in the top center of the window, counting each 1/4 mile lap in sequence of completion (1, 2, 3, etc.)

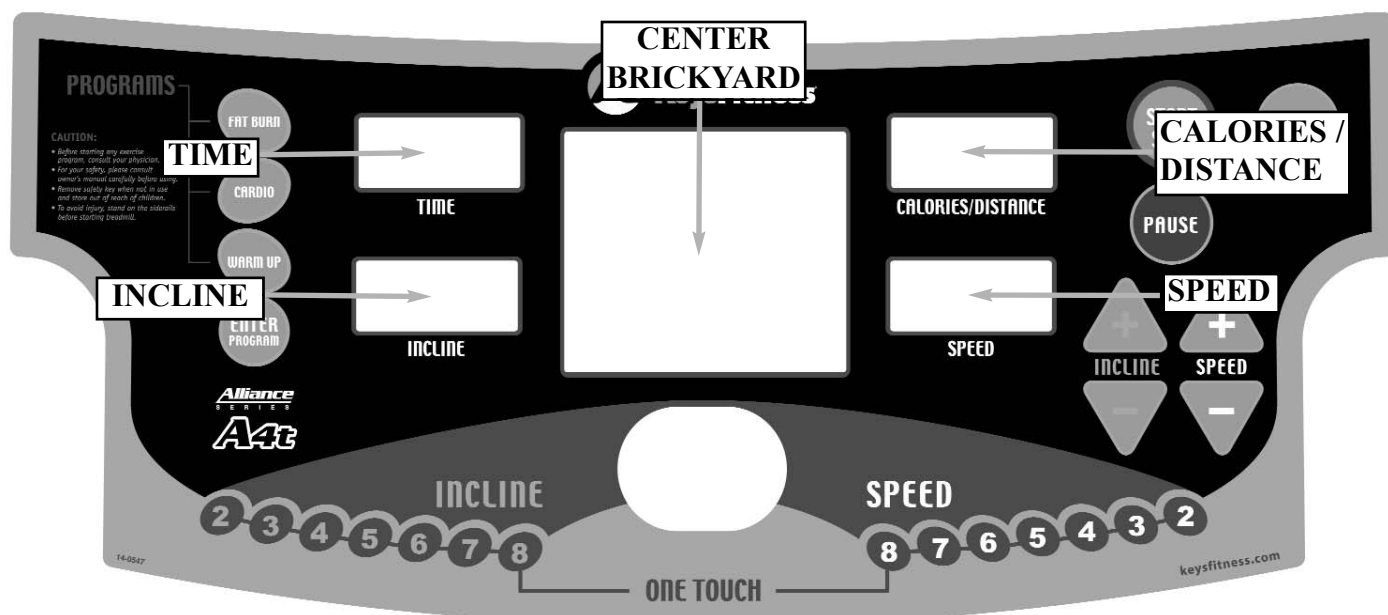

QUICK START / MANUAL MODE

- ◆ Plug into a surge protector outlet. Attach the **Red Safety Key** on to the treadmill console.
- ◆ Stand on the treadmill and straddle belt. Attach safety key clip to your clothes.
- ◆ Press **POWER** button. There will be an eight (8) second delay after pressing the **POWER** button before data can be entered. The **TIME** window will flash.
- ◆ Press **START/STOP** button. Belt will begin to move after 4 seconds. Step on belt slowly after the belt starts moving. Speed or incline may be adjusted by using the appropriate + (increase) or – (decrease) button.
- ◆ To end your workout, press **START/STOP** button. Belt will gradually slow to zero.
- ◆ To pause your workout, press **PAUSE**.
- ◆ To re-start after pausing: Press the **PAUSE** button. **WARNING: THE TREADMILL BELT WILL RESUME AT THE SPEED THE TREADMILL WAS MOVING BEFORE PAUSING.**
- ◆ Countdown Time, Preset Speed and/or Incline: Time, Speed, and Incline may be preset prior to getting started. After pressing the **POWER** button, the time window will blink. Use the **SPEED +** or – arrows to select your workout time, then press the **ENTER PROGRAM** button. The **SPEED** window will now be flashing. Using the same + or – arrows, select the speed for your workout, then press **ENTER PROGRAM**. Now the **INCLINE** window will be flashing. Use the **INCLINE +** or – arrows to set your workout incline, then press **ENTER PROGRAM**. To start, press the **START/STOP** button.

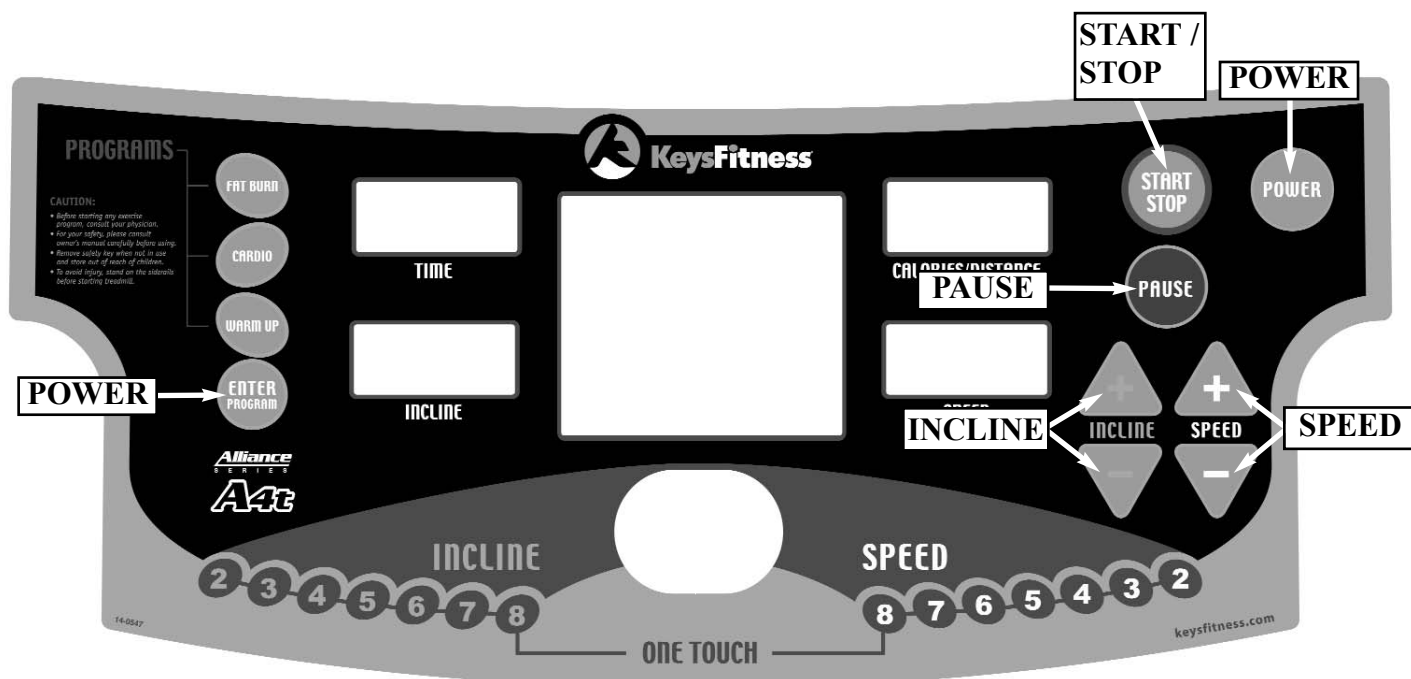

PROGRAM MODE

Plug treadmill into a surge protector outlet. Attach the **Red Safety Key** on to the treadmill console.

- ◆ Stand on the treadmill and straddle belt. Attach safety key clip to your clothes.
- ◆ Press **POWER** button. There will be an eight (8) second delay before data can be entered. The **TIME** window will flash.
- ◆ There are three (3) pre-set and six (6) semi-custom pre-set programs on the **A4t treadmill**. The treadmill includes **FAT BURN**, **CARDIO**, and **WARM-UP** programs. To select the program press the corresponding button on the console display
- ◆ Press **START/STOP** button. Belt will begin to move after 4 seconds. Step on belt slowly after the belt starts moving.
- ◆ **CUSTOMIZING PROGRAMS in P1 and P2 Mode:** Each pre-set program (Fat Burn, Cardio, and Warm-up) can be customized in the P1 or P2 mode. After making the program selection, the Center Brickyard window will read “OP”. The “OP” refers to “original program” and is preset. The program name you select will illuminate on the console display. Press the **PROGRAM DOWN** button once more and the Center Brickyard window will read P1. The “P1” mode is now accessed. Press **ENTER PROGRAM**. You can now program the Time, Speed, and Incline in P1 mode, which will be saved for future workouts.
 - 1) The **TIME** window will blink. Use the **SPEED +** or **-** arrows to select your workout time. Press **ENTER PROGRAM**.
 - 2) The **SPEED** window will then blink. Use the same **+** or **-** arrows to select the speed for your workout. Press **ENTER PROGRAM**.
 - 3) The **INCLINE** window will then blink. Use the **INCLINE +** or **-** arrows to set your workout incline. Press **ENTER PROGRAM**.

To start, press the **START/STOP** button. To access P2 mode, press the **PROGRAM UP** or **DOWN** button for desired program, then press the **PROGRAM UP** or **DOWN** button (once for OP, twice for P1, three times for P2). Follow the above steps 1-3 to customize P2 settings.

- ◆ **TO CHANGE A PREVIOUSLY PROGRAMMED P1, P2, or user program:** Once you have programmed the P1 or P2 modes, you will need to use the **PAUSE** button to change the program you previously entered. For instance to change to a new setting in P1-FAT BURN, press the **PROGRAM UP** or **DOWN** to select the **FAT BURN** program. Next, press the same button once more to access P1. Then press the **PAUSE** button to get the **TIME** window to flash. Follow the directions above to continue to change the program.

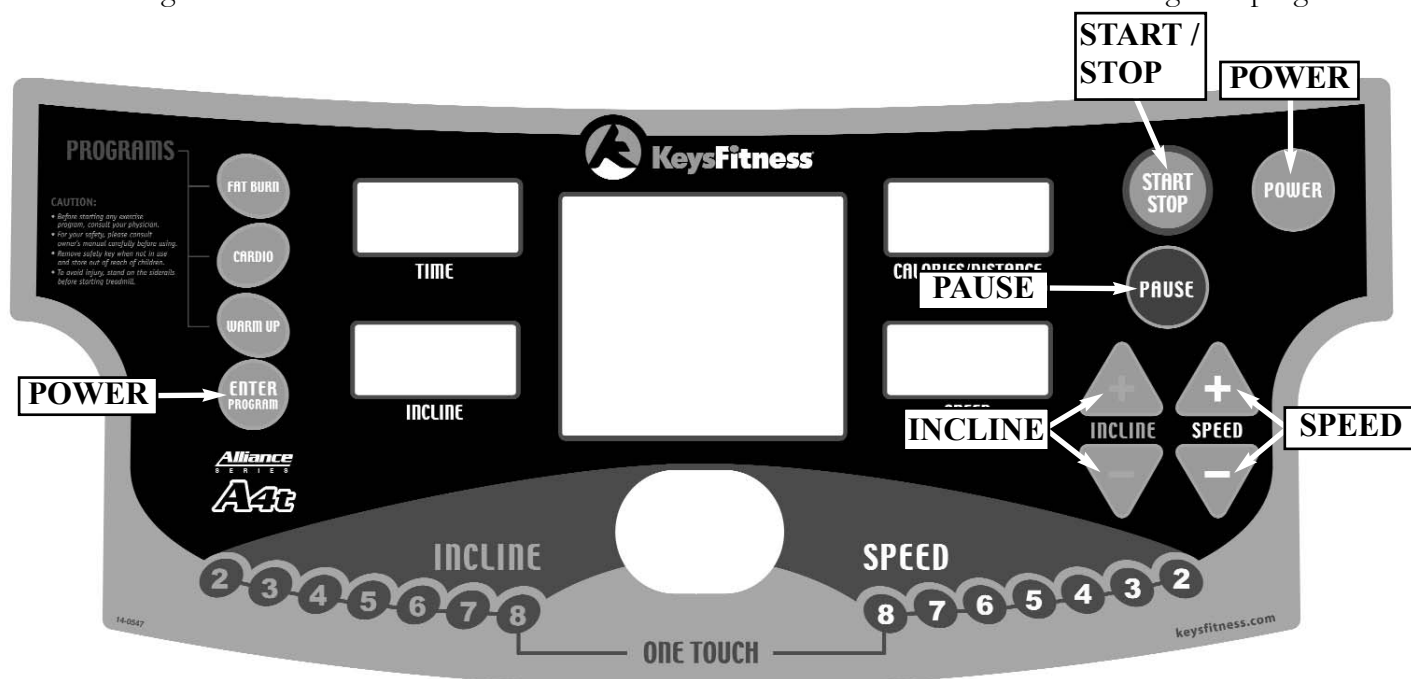

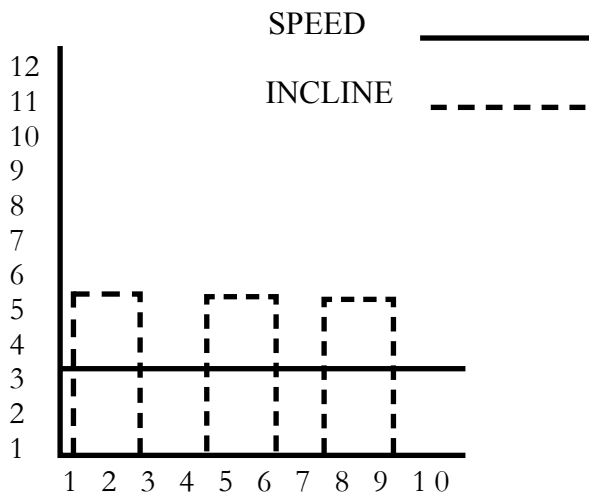

The **Fat Burn Program** is designed to vary the treadmill elevation, while maintaining a constant walking belt speed.

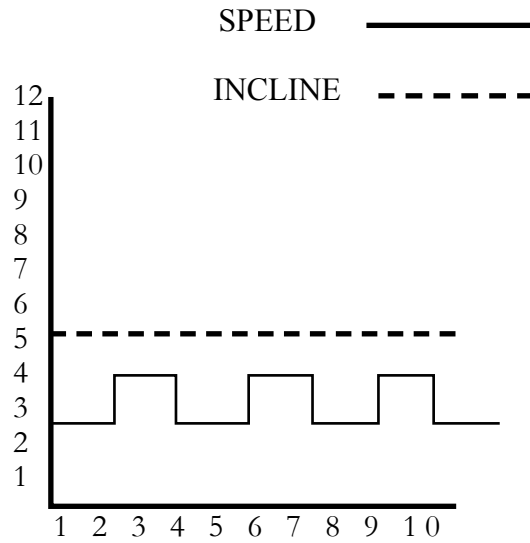

The **Cardio Program** is designed to vary the treadmill Speed, while maintaining a constant Elevation.

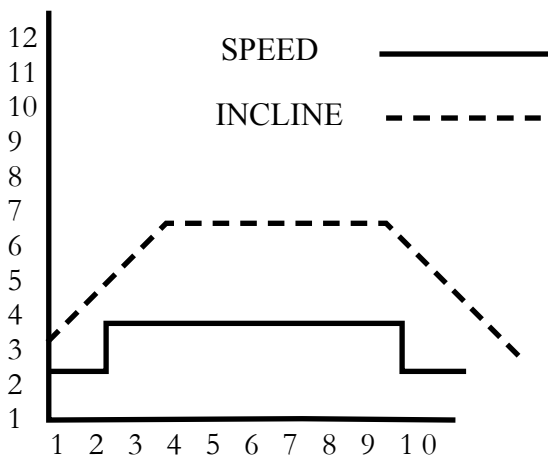

The **Warm Up Program** is designed to gradually increase the treadmill Speed and Elevation in the first segment (warm up) and gradually decrease the treadmill Speed and Elevation in the last segment (cool down). This is also known as a Plateau program.

EXERCISE GUIDELINES

WARNING! Before beginning this or any exercise program, you should consult your physician. This is especially important for individuals over the age of 35 or individuals with pre-existing health problems.

Warming up prepares the body for the exercise by increasing circulation, supplying more oxygen to the muscles and raising body temperature. Begin each workout with 5 to 10 minutes of stretching and light exercise to warm up. The photos on this page show several forms of basic stretching you may perform before your workouts. In order to achieve an adequate warm-up, perform each stretch three times.

TOE TOUCH STRETCH

Stand, bending your knees slightly and slowly bend forward from your hips. Allow your back and shoulders to relax as you reach down toward your toes as far as possible. Hold for 15 counts, then relax. This will stretch your hamstrings, back of knees, and back.



HAMSTRING STRETCH

Sit with one leg extended. Bring the sole of the opposite foot toward you and rest it against the inner thigh of your extended leg. Reach toward your toes as far as possible. Hold for 15 counts, then relax. This will stretch your hamstrings, lower back, and groin.



CALF/ACHILLES STRETCH

With one leg in front of the other, reach forward and place your hands against a wall. Keep your back leg straight and your back foot flat on the floor. Bend your front leg, lean forward and move your hips toward the wall. Hold for 15 counts, then relax. To cause further stretching of the Achilles tendon, bend your back leg as well. This will stretch your calves, Achilles tendons, and ankles.



QUADRICEPS STRETCH

With one hand against a wall for balance, reach back and grasp one foot with your other hand. Bring your heel as close to your buttocks as possible. Hold for 15 counts, then relax. This will stretch your quadriceps and hip muscles.



INNER THIGH STRETCH

Sit with the soles of your feet together and your knees outward. Pull your feet toward your groin area as far as possible. Hold for 15 counts, then relax. This will stretch your quadriceps and hip muscles.

Change to MPH or KPH

Your treadmill will operate in British Units (miles per hour) or International Units (kilometers per hour). All treadmills are calibrated at the factory for British Units (miles per hour). To change the display to read in kilometers, follow the steps described here:

- 1) Turn power OFF on the console. (Do not unplug treadmill.) Attach the magnet safety key to the console.
- 2) Activate the calibration mode switch by inserting the eraser end of a pencil into the opening in the backside of the console (see diagram below).
- 3) Depress the calibration mode switch ONCE. CL11 should appear in the TIME window.
- 4) Pressing the SPEED +/- button will activate your choice.
- 5) To accept the setting, press the POWER button.



Calibration Sequence

Do not attempt to calibrate the treadmill unless an Error Code is present. See Error Messages (page 17). Our treadmill is equipped with a software package that will perform a calibration sequence unique to your specific model number.

Please perform the following steps to calibrate the **Alliance A4t Treadmill**.

1. Unplug power cord from outlet strip.
2. Attach Safety Key to console.
3. Plug power cord into outlet strip.
4. Initiate calibration sequence. Locate the hole on the back of the console and insert the eraser end of a pencil through the hole and press the calibration switch **twice**. As show on **page 13**.
5. **CL21** should appear in the Time window, if not, continue to press the calibration switch until CL21 appears.

Note: During the calibration sequence, the Time window will display which step you are at in the process (C21, C22, C23 and so on). The CAL/DIST window will display which key should be pressed next. For example, “E” for Enter, “P” for Power, or “SS” for Start / Stop.

6. **CL21:** MPH or KPH will be flashing in the Speed window, pressing the Speed +/- button will toggle options. Choose **MPH** (KPH), press Enter.
7. **CL22:** 8, 10, or 12 (13, 16, or 20 in KPH mode) will be displayed in the Speed window, pressing the Speed +/- button will toggle options. Choose **10** (or 16 for KPH mode), press Enter.
8. **CL23:** FFF, UUU, or HHH will be displayed in the Speed window, pressing the Speed +/- button will toggle options. Choose **UUU**, press Enter.
9. **CL24:** 111 or 222 will be displayed in the Speed window, pressing the Speed +/- button will toggle options. Choose **222**, press Enter.
10. **CL25:** AL1 or AL2 will be displayed in the Speed window, pressing the Speed +/- button will toggle options. Choose **AL2**, press Enter.
11. **CL26:** OPA or OPI will be displayed in the Speed window, pressing the Speed +/- button will toggle options. Choose **OPA**, press Enter.
12. **CL27:** Blank (nothing), “a”, “b”, “c”, “d” or “e” will be displayed in the Incline window, pressing the Speed +/- button will toggle options. Choose **“blank”**, press Enter.
13. CAL/DIST window will display **“55”**. Press Start / Stop. **“E”** will display in CAL/DIST window.
14. Press Enter Program button.
15. At this time, make sure you are not standing on the walking belt, as the machine will automatically initiate belt movement and run through a complete calibration and diagnostic routine.
Press **Enter**. Belt will begin to move. Unit will begin self-calibration.
16. When Speed and Incline calibration has finished, press Power button **twice**, display should be blank, and treadmill should be ready for use.

To avoid possible damage to the treadmill and the possibility of injury, do not operate the treadmill until the problem is corrected. Call Keys Fitness Customer Service at (888)-340-0482 if problem persists.

Belt Adjustment

WARNING! Do not over-tighten rollers! This will cause premature roller bearing failure!

Belt adjustment and tension performs two functions: adjustment for tension and centering. Your new treadmill comes pre-adjusted from the factory for tension and centering. Please follow the procedures below if the belt shifts to the left or right while walking:

WALKING BELT IS SHIFTING TO THE LEFT (Diagram 1)

First, turn treadmill on to run at 1 mph. Using the hex key provided, turn the left rear roller adjustment bolt $\frac{1}{4}$ turn in the clockwise direction. Next, run the treadmill at 2.5 mph. You should see the belt start to correct itself by moving back toward the center. Repeat the above procedure until the walking belt is centered. It may be necessary to set walking belt tension once you have completed this procedure if the belt feels like it is slipping while walking. Refer below to the “Walking Belt Slipping” instructions.



Diagram 1

WALKING BELT IS SHIFTING TO THE RIGHT (Diagram 2)

First, turn the treadmill on to run at 1 mph. Using the hex key provided, turn the right rear roller adjustment bolt $\frac{1}{4}$ turn in the clockwise direction. Next, run the treadmill at 2.5 mph. You should see the belt start to correct itself, moving back toward the center. Repeat the above procedure until the walking belt is centered. It may be necessary to set walking belt tension once you have completed this procedure if the belt feels like it is slipping while walking. Refer below to the “Walking Belt Slipping” instructions.



Diagram 2

WALKING BELT IS SLIPPING DURING USE (Diagram 3)

First, unplug the power cord from the surge protector. Using the hex key provided, turn both left and right rear roller adjustment bolts the same distance, usually a $\frac{1}{4}$ turn, in the clockwise direction. Plug the power cord back into the surge protector and run the treadmill at 2.5 mph. You should now walk on the belt to determine if the belt is still slipping. Repeat the above procedure until the walking belt is not slipping. The tension should be just tight enough not to slip.



Diagram 3

Note: Turning the hex key counter clockwise brings the rear rollers and belt towards you.

Turning the hex key clockwise pushes the rear roller and belt away from you.

Maintenance Instructions

WARNING! Before performing any maintenance to your treadmill, always unplug the power cord from the surge protector.

CLEANING: Routine cleaning of your unit will extend the life of your unit.

WARNING! To prevent electrical shock, be sure the power to the treadmill is OFF and the unit is unplugged from the wall electrical outlet before attempting any cleaning or maintenance.

AFTER EACH WORKOUT: Wipe off the console and other treadmill surfaces with a clean, water dampened soft cloth to remove excess perspiration. **USE NO CHEMICALS.**

WEEKLY: Use of a treadmill mat is recommended for ease of cleaning. Dirt from your shoes contacts the belt and eventually makes it to underneath the treadmill. Vacuum underneath treadmill once a week.

DECK LUBRICATION: The walking belt has been pre-lubricated at the factory. However, it is recommended that the walking board be checked periodically for lubrication to ensure optimal treadmill performance.

Every 30 days or 30 hours of operation, lift the sides of the walking belt and feel the top surface of the walking board as far under as you can reach. If you feel signs of silicone, no further lubrication is required. If it feels dry to the touch, lubrication is needed. Keys Fitness recommends “Lube N Walk” for cleaning and lubricating the treadmill belt and deck. Ask your retailer or call Keys Fitness at 888-340-0482. You may also use silicone such as “Napa 8300” (available at most NAPA Auto Parts stores).

TO APPLY LUBRICANT TO THE WALKING BOARD

- 1) Position the walking belt so that the seam is located on top and in the center of the center of the walking board.
- 2) Insert the spray nozzle into the spray head of the lubricant can.
- 3) While lifting the side of the walking belt, position the spray nozzle between the walking belt and the board approximately 6” from the front of the treadmill. Apply the silicone spray to the walking board, moving from the front of the treadmill to the rear. Repeat this on the other side of the belt. Spray approximately 4 seconds on each side.
- 4) Allow the silicone to ‘set’ for one minute before using the treadmill.

WARNING: Do not over-lubricate the walking board. Excess lubricant should be wiped off with a clean towel.

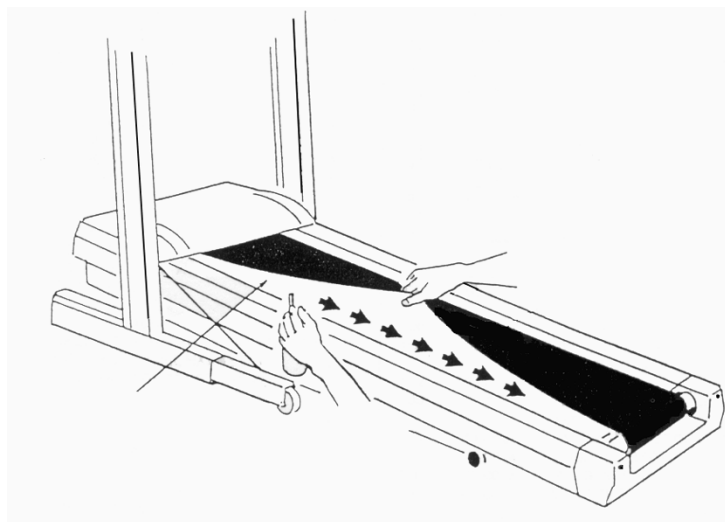

Treadmill Error Messages.

Your treadmill is equipped with a software package that enables error messages to be displayed when there is a problem. The following error codes will be displayed in the console display windows.

Safety Interlock Error Messages

SI 1 - Safety key missing, replace and try again.

SI 2 - Over voltage protection trip. Notify Keys Fitness Customer Service.

Other Error Messages

E11 - Lack of speed feedback data from belt motor. Attempt calibration. See Calibration Sequence section on **page 16** of this Owners Manual for detailed information.

E22 - Under Speed condition detected from the belt motor. Attempt calibration. See Calibration Sequence section for detailed information.

E33 - Over Speed condition detected from the belt motor. Attempt calibration. See Calibration Sequence section for detailed information.

E44 - Stuck key detected at power up, Notify Keys Fitness Customer Service.

To avoid possible damage to the treadmill and the possibility of injury, do not operate the treadmill until the problem is corrected. Call Keys Customer Service at 888-340-0482.

Treadmill will not start.

1. Is the **Safety Key** inserted into the treadmill Console?
2. Make sure the power cord is plugged into a surge protector, the surge protector is plugged into a properly grounded outlet, and the surge protector is turned on. (Refer to “Power Requirements” on **page 7**.)
3. Check the circuit breaker located on the front of the treadmill. If the switch protrudes, it has tripped. Wait five minutes and then press the switch back in.
4. Check the house electrical breaker box and the circuit breaker for the room where the treadmill is located. If it has tripped, reset or have an electrician replace the breaker in home.
5. Have an electrician check to insure there is adequate voltage at the outlet.

Treadmill loses power during use.

1. Check the circuit breaker located on the front of the treadmill. If the switch protrudes, it has tripped. Wait five minutes and then press the switch back in.
2. Check the house electrical breaker box and the circuit breaker for the room where the treadmill is located. If it has tripped, reset or have an electrician replace the breaker in home.
3. If the treadmill will not operate, please call Keys Fitness Customer Service at (888)-340-0482.

Treadmill walking belt slows during use.

1. Check to make sure the treadmill is securely plugged into an UL-listed surge protector, rated at 15 amps, with a 14-gauge cord of five feet or less and the surge protector is securely plugged into the outlet.
2. If treadmill will not operate, please call Keys Fitness Customer Service at (888)-340-0482.

Treadmill walking belt slips or is not centered on rear roller.

1. Refer to “Belt Adjustment” section on **page 15**.
2. Need help? Call Keys Fitness Customer Service at (888)-340-0482.

Treadmill Error Messages.

Your treadmill is equipped with a software package that enables error messages to be displayed when there is a problem.

To avoid possible damage to the treadmill and the possibility of injury, do not operate the treadmill until the problem is corrected. Call Keys Fitness Customer Service at (888)-340-0482, or see “Error Messages” on page 17 of this Owner’s Manual.

Alliance A4t Treadmill

REF#	KEYS PART#	DESCRIPTION	QTY.
1	23-0163	UPRIGHT ASSEMBLY	1
2	23-0123	DECK ASSEMBLY	1
3	23-0003	REAR ELEVATION ASSEMBLY	1
4	19-0010	UPRIGHT PIVOT BRACKET	2
5	19-0032	SPRING ANCHOR BRACKET	2
6	19-0019	BELT GUIDES	2
7	19-0015	MOTOR COVER BRACKET	7
8	10-0028	BOARD ISOLATOR	8
9	24-0218	FRONT ROLLER	1
10	09-0013	REAR ROLLER	1
11	04-0025	WALK BELT	1
12	19-0013	FOOT LOCKING MECHANISM LATCH	1
13	12-0044	MOTOR	1
14	12-0022	ACTUATOR	1
15	20-0003	ACTUATOR EXTENSION	1
16	08-0051	MOTOR CONTROLLER	1
17	04-0017	POLY V-BELT	1
18	06-0008	REAR END CAP	1
19	06-0018	MOTOR BASE	1
20	06-0019	CENTER BASE	1
21	06-0020	END BASE	1
22	02-0002A	DECK LIFT SPRING	2
23	06-0027	PIVOT COVER	2
24	06-0105	MOTOR COVER	1
25	10-0020	GRIP	2
26	08-0027	REMOTE TOGGLE	2
27	24-0273	CONSOLE ASSEMBLY	1
28	05-0036	EXTRUSION	2
29	03-0011	WALK BOARD	1
30	06-0029	WHEEL SPACER	4

Exploded View

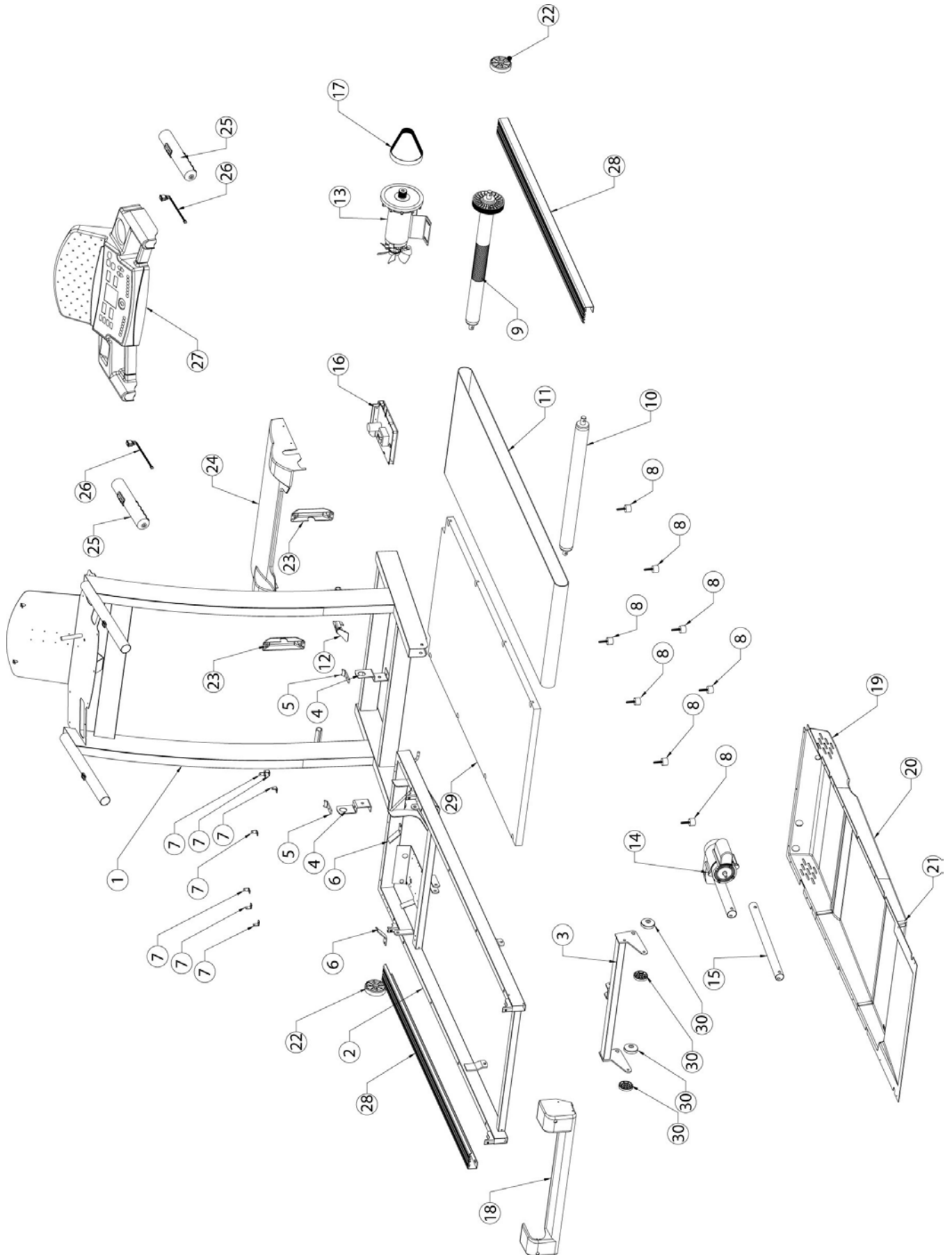

Warranty Information



KEYS FITNESS PRODUCTS, LP - LIMITED WARRANTY

PRODUCT: Alliance A4t Treadmill

HOME USE WARRANTY:

Frame:	Motor:	Deck & Belt:	Parts:	Labor:
Lifetime	10 Years	5 Years	2 Years	1 Year

This Limited Warranty applies in the United States and Canada to products manufactured or distributed by Keys Fitness Products, LP ("Keys") under the KEYS brand name. The warranty period to the original purchaser is listed above in the table.

Keys warrants that the Product you have purchased for use from Keys or from an authorized Keys reseller is free from defects in materials or workmanship under normal use during the warranty period. Your sales receipt, showing the date of purchase of the Product, is your proof of purchase. This warranty only extends to you, the original purchaser. It is not transferable to anyone who subsequently purchases the Product from you. It excludes expendable parts (wear items). Wear items pertain to components that might need to be replaced due to normal wear and tear. These items vary per product but will include computer overlays, pedal straps, rope cords, seats, grips, chains, bottom bracket assemblies, pads, upholstery, pulleys, bearings, etc. Please contact a Keys Fitness customer service representative for specifics on wear items. This Limited Warranty becomes VALID ONLY if the product is purchased through a Keys Fitness authorized dealer unless otherwise authorized by Keys Fitness in writing.

During the warranty period Keys will repair or replace (at Keys' option) the product if it becomes defective, malfunctions, or otherwise fails to conform with this Limited Warranty under normal use. In repairing the Product, Keys may replace defective parts, or at the option of Keys, serviceable used parts that are equivalent to new parts in performance. All exchanged parts and Products replaced under this warranty will become the property of Keys. Keys reserves the right to change manufacturers of any part to cover any existing warranty.

This warranty DOES NOT COVER shipping charges, export taxes, custom duties and taxes, or any other charges associated with transportation of the parts or Product.

To obtain warranty service, you must contact a Keys authorized retailer, service technician or Keys Fitness at our phone numbers located in this manual. Any parts determined to be defective must be returned to Keys to obtain warranty service. You must prepay any shipping charges, export taxes, custom duties and taxes, or any other charges associated with transportation of the parts or Product. In addition, you are responsible for insuring any parts or Product shipped or returned. You assume the risk of loss during shipment. You must present Keys with proof-of-purchase documents (including the date of purchase). Any evidence of alteration, erasing or forgery of proof-of-purchase documents will be cause to void this Limited Warranty.

This warranty does not extend to any product not purchased from Keys or from an authorized Keys reseller. This Limited Warranty does not extend to any Product that has been damaged or rendered defective; (a) as a result of accident, misuse, or abuse; (b) by the use of parts not manufactured or sold by Keys; (c) by modification of the Product or normal wear and tear; (d) operation on incorrect power supplies; or (e) as a result of service by anyone other than Keys, or an authorized Keys warranty service provider. Product on which the serial number has been defaced or removed is not eligible for warranty service. Should any Product submitted for warranty service be found ineligible, an estimate of repair cost will be furnished and the repair will be made if requested by you upon Keys' receipt of payment or acceptable arrangements for payment.

EXCEPT AS EXPRESSLY SET FORTH IN THIS WARRANTY, KEYS MAKES NO OTHER WARRANTIES, EXPRESSED OR IMPLIED, INCLUDING ANY IMPLIED WARRANTIES OF MERCHANTABILITY AND FITNESS FOR A PARTICULAR PURPOSE. KEYS EXPRESSLY DISCLAIMS ALL WARRANTIES NOT STATED IN THIS LIMITED WARRANTY. ANY IMPLIED WARRANTIES THAT MAY BE IMPOSED BY LAW ARE LIMITED TO THE TERMS OF THIS LIMITED WARRANTY. NEITHER KEYS NOR ANY OF ITS AFFILIATES SHALL BE RESPONSIBLE FOR INCIDENTAL OR CONSEQUENTIAL DAMAGES. SOME STATES DO NOT ALLOW LIMITATIONS ON HOW LONG AN IMPLIED WARRANTY LASTS OR THE EXCLUSION OR LIMITATION OF INCIDENTAL OR CONSEQUENTIAL DAMAGES, SO THE ABOVE LIMITATIONS OR EXCLUSION MAY NOT APPLY TO YOU. This Limited Warranty gives you specific legal rights and you may also have other rights that may vary from state to state. This is the only express warranty applicable to Keys-branded products. Keys neither assumes nor authorizes anyone to assume for it any other express warranty.

PLEASE SEND IN THE WARRANTY CARD WITHIN TEN (10) DAYS OF PURCHASE TO REGISTER YOUR UNIT WITH KEYS FITNESS PRODUCTS, LP.
MAIL WARRANTY CARD TO:
KEYS FITNESS PRODUCTS, PO BOX 551239, DALLAS, TX 75355



Customer Service

(888) 340-0482

Keys Fitness Products

4009 Distribution Drive
Suite 250
Garland, TX 75041

www.keysfitness.com