

CHICAGO
Electric® Power Tools

COMPACT BELT SANDER

Model 66891

SET UP AND OPERATING INSTRUCTIONS



Distributed exclusively by Harbor Freight Tools®.

3491 Mission Oaks Blvd., Camarillo, CA 93011

Visit our website at: <http://www.harborfreight.com>



**Read this material before using this product.
Failure to do so can result in serious injury.
SAVE THIS MANUAL.**

Copyright© 2009 by Harbor Freight Tools®. All rights reserved. No portion of this manual or any artwork contained herein may be reproduced in any shape or form without the express written consent of Harbor Freight Tools. Diagrams within this manual may not be drawn proportionally. Due to continuing improvements, actual product may differ slightly from the product described herein. Tools required for assembly and service may not be included.

For technical questions or replacement parts, please call 1-800-444-3353.

CONTENTS

ASSEMBLY DIAGRAM..... 16

IMPORTANT SAFETY INFORMATION	3
GENERAL POWER TOOL SAFETY WARNINGS.....	3
VIBRATION SAFETY	6
GROUNDING	7
DOUBLE INSULATED TOOLS: TOOLS WITH TWO PRONG PLUGS	7
EXTENSION CORDS	8
SYMBOLGY.....	8
SPECIFICATIONS.....	9
UNPACKING	9
ASSEMBLY.....	9
INSTRUCTIONS FOR PUTTING INTO USE	9
OPERATING INSTRUCTIONS	9
TOOL SET UP	9
WORK PIECE AND WORK AREA SET UP	11
GENERAL OPERATING INSTRUCTIONS	12
MAINTENANCE AND SERVICING	12
CLEANING, MAINTENANCE, AND LUBRICATION	12
LIMITED 90 DAY WARRANTY	13
TROUBLESHOOTING.....	14
PARTS LIST	15
PLEASE READ THE FOLLOWING CAREFULLY	15

SAVE THIS MANUAL

Keep this manual for the safety warnings and precautions, assembly, operating, inspection, maintenance and cleaning procedures. Write the product's serial number in the back of the manual near the assembly diagram (or month and year of purchase if product has no number). Keep this manual and the receipt in a safe and dry place for future reference.

IMPORTANT SAFETY INFORMATION

In this manual, on the labeling, and all other information provided with this product:



This is the safety alert symbol. It is used to alert you to potential personal injury hazards. Obey all safety messages that follow this symbol to avoid possible injury or death.

DANGER

DANGER indicates a hazardous situation which, if not avoided, will result in death or serious injury.

WARNING

WARNING indicates a hazardous situation which, if not avoided, could result in death or serious injury.

CAUTION

CAUTION, used with the safety alert symbol, indicates a hazardous situation which, if not avoided, could result in minor or moderate injury.

NOTICE

NOTICE is used to address practices not related to personal injury.

CAUTION

CAUTION, without the safety alert symbol, is used to address practices not related to personal injury.

General Power Tool Safety Warnings



WARNING Read all safety warnings and instructions. Failure to follow the warnings and instructions may result in electric shock, fire and/or serious injury. Save all warnings and instructions for future reference. The term "power tool" in the warnings refers to your mains-operated (corded) Compact Belt Sander.

1. **Work area safety:**
 - a. **Keep work area clean and well lit.** Cluttered or dark areas invite accidents.
 - b. **Do not operate this Compact Belt Sander in explosive atmospheres, such as in the presence of flammable liquids, gases or dust.** Power tools create sparks which may ignite the dust or fumes.
 - c. **Keep children and bystanders away while operating this Compact Belt Sander.** Distractions can cause you to lose control.
2. **Electrical safety:**
 - a. **Power tool plugs must match the outlet. Never modify the plug in any way. Do not use any adapter plugs with grounded power tools.**

Unmodified plugs and matching outlets will reduce risk of electric shock.

NOTE: This Compact Belt Sander has a 2-Prong Power Cord plug.

- b. **Avoid body contact with grounded surfaces such as pipes, radiators, ranges and refrigerators.** *There is an increased risk of electric shock if your body is grounded.*
 - c. **Do not expose power tools to rain or wet conditions.** *Water entering this Compact Belt Sander will increase the risk of electric shock.*
 - d. **Do not abuse the cord. Never use the cord for carrying, pulling or unplugging this Compact Belt Sander. Keep the cord away from heat, oil, sharp edges or moving parts.** *Damaged or entangled cords increase the risk of electric shock.*
 - e. **When operating this Compact Belt Sander outdoors, use an extension cord suitable for outdoor use.** *Use of a cord suitable for outdoor use reduces the risk of electric shock.*
 - f. **If operating this Compact Belt Sander in a damp location is unavoidable, use a Ground Fault Circuit Interrupter (GFCI) protected supply.** *Use of a GFCI reduces the risk of electric shock.*
3. **Specific Personal safety Rules:**
- a. **Stay alert, watch what you are doing and use common sense when operating this Compact Belt Sander. Do not use while you are tired or under the influence of drugs, alcohol or medication.** *A moment of inattention while operating power tools may result in serious personal injury.*
 - b. **Use personal protective equipment. Always wear ANSI-approved safety eye protection and a dust-mask/respirator.** *Safety equipment such as non-skid safety shoes, a hard hat, or hearing protection used for appropriate conditions will reduce personal injuries.*
 - c. **Do not allow children to use this Compact Belt Sander.** *This power tool is not a toy and should not be operated by any child, or untrained user, at any time.*
 - d. **Severe abrasion hazard.** *Keep hands and fingers clear of moving sanding belts, and do not let your fingers rest over the front or right edge of the Compact Belt Sander. If the sanding belt should run off, or if it is not properly adjusted, your fingers could come in contact with the moving belt possibly causing serious personal injury.*
 - e. **Severe pinching hazard.** *Keep hands and fingers clear of front roller at all times. Failure to do so may result in fingers being pinched and/or other personal injury.*
- WARNING!** To reduce the risk of injury, always secure work to prevent it from being thrown back towards the user.
- f. **Hold this Compact Belt Sander by the insulated gripping surfaces when performing a job near electrical wiring.** *This will help keep you safe if electrical contact is made.*
 - g. **Clean this Compact Belt Sander frequently to prevent buildup of debris on moving parts.** *Built up debris may fly from the power tool causing personal injury.*

- h. **Prevent unintentional starting.** Ensure the switch is in the off-position before connecting to your power source, picking up or carrying the tool. *Carrying this Compact Belt Sander with your finger on the switch or energizing it while the switch is in the "ON" position invites accidents.*
 - i. **Do not overreach. Keep proper footing and balance at all times.** *This enables better control of the Compact Belt Sander in unexpected situations.*
 - j. **Dress properly. Do not wear gloves, loose clothing or jewelry. Keep your hair, clothing and gloves away from moving parts.** *Gloves, loose clothes, jewelry or long hair can be caught in moving parts causing serious personal injury.*
 - k. **If devices are provided for the connection of dust extraction and collection facilities, ensure these are connected and properly used.** *Use of these devices can reduce dust-related hazards.*
 - l. **Only use safety equipment that has been approved by an appropriate standards agency.** *Unapproved safety equipment may not provide adequate protection. Eye protection must be ANSI-approved and breathing protection must be NIOSH-approved for the specific hazards in the work area.*
4. **Power tool use and care:**
- a. **Do not force this Compact Belt Sander, and always use the correct power tool for your application.** *The correct power tool will do the job better and safer at the rate for which it was designed.*
 - b. **Do not use this Compact Belt Sander if the switch does not turn it on and off.** *Any power tool that cannot be controlled with the switch is dangerous and must be repaired.*
 - c. **Disconnect the plug from the power source before making any adjustments, changing accessories, or storing.** *Such preventive safety measures reduce the risk of accidental starting.*
 - d. **Avoid unintentional starting.** *Prepare to begin work before turning on the Compact Belt Sander.*
 - e. **Do not lay the Compact Belt Sander down until it has come to a complete stop.** *Moving parts can grab the surface and pull the tool out of your control.*
 - f. **When using a handheld power tool, maintain a firm grip on the tool with both hands to resist starting torque.**
 - g. **Do not leave the tool unattended when it is plugged into an electrical outlet.** *Turn off the tool, and unplug it from its electrical outlet before leaving.*
 - h. **Use this Compact Belt Sander in accordance with these instructions, taking into account the working conditions and the work to be performed.** *Use for operations different from those intended could result in a hazardous situation.*
 - i. **Store the idle Compact Belt Sander out of the reach of children and do not allow persons unfamiliar with it, or these instructions to operate.** *Power tools are dangerous in the hands of untrained users.*

5. **Service:**

a. **Maintain this Compact Belt**

Sander. *Check for misalignment or binding of moving parts, breakage of parts and any other condition that may affect a safe operation. If damaged, have the Compact Belt Sander repaired before use. Many accidents are caused by poor maintenance.*

b. **Have your power tool serviced by a qualified repair person using only identical replacement parts.**

This will ensure that the safety of the power tool is maintained.

c. **Maintain labels and nameplates on the tool.**

These carry important safety information. If unreadable or missing, contact Harbor Freight Tools for a replacement.

WARNING! People with pacemakers should consult their physician(s) before use. Electromagnetic fields in close proximity to heart pacemaker could cause pacemaker interference or pacemaker failure. In addition, people with pacemakers should:

- Avoid operating alone.
- Do not use with power switch locked on.
- Properly maintain and inspect to avoid electrical shock.
- Any power cord must be properly grounded. Ground Fault Circuit Interrupter (GFCI) should also be implemented – it prevents sustained electrical shock.

WARNING! Some dust created by power sanding, sawing, grinding, drilling, and other construction activities, contains chemicals known [to the State of California] to cause cancer, birth defects or other reproductive harm.

Some examples of these chemicals are:

- Lead from lead-based paints
- Crystalline silica from bricks and cement or other masonry products
- Arsenic and chromium from chemically treated lumber

Your risk from these exposures varies, depending on how often you do this type of work. To reduce your exposure to these chemicals: work in a well ventilated area, and work with approved safety equipment, such as those dust masks that are specially designed to filter out microscopic particles. (California Health & Safety Code § 25249.5, *et seq.*)

WARNING! Handling the cord on this product will expose you to lead, a chemical known to the State of California to cause cancer, and birth defects or other reproductive harm. Wash hands after handling. (California Health & Safety Code § 25249.5, *et seq.*)

Vibration Safety

This tool vibrates during use. Repeated or long-term exposure to vibration may cause temporary or permanent physical injury, particularly to the hands, arms and shoulders. To reduce the risk of vibration-related injury:

1. Anyone using vibrating tools regularly or for an extended period should first be examined by a doctor and then have regular medical check-ups to ensure medical problems are not being caused or worsened from use. Pregnant women or people who have impaired blood circulation to the hand, past hand injuries, ner-

vous system disorders, diabetes, or Raynaud's Disease should not use this tool. If you feel any symptoms related to vibration (such as tingling, numbness, and white or blue fingers), seek medical advice as soon as possible.

2. Do not smoke during use. Nicotine reduces the blood supply to the hands and fingers, increasing the risk of vibration-related injury.
3. Wear suitable gloves to reduce the vibration effects on the user.
4. Use tools with the lowest vibration when there is a choice.
5. Include vibration-free periods each day of work.
6. Grip tool as lightly as possible (while still keeping safe control of it). Let the tool do the work.
7. To reduce vibration, maintain the tool as explained in this manual. If any abnormal vibration occurs, stop use immediately.
8. **The warnings, precautions, and instructions discussed in this instruction manual cannot cover all possible conditions and situations that may occur. It must be understood by the operator that common sense and caution are factors which cannot be built into this product, but must be supplied by the operator.**



SAVE THESE INSTRUCTIONS.

GROUNDING

WARNING TO PREVENT ELECTRIC SHOCK



AND DEATH FROM INCORRECT GROUNDING WIRE CONNECTION:
Check with a qualified electrician if you are in doubt as to whether the outlet is properly grounded. Do not modify the power cord plug provided with the tool. Never remove the grounding prong from the plug. Do not use the Compact Belt Sander if the power cord or plug is damaged. If damaged, have it repaired by a service facility before use. If the plug will not fit the outlet, have a proper outlet installed by a qualified electrician.

Double Insulated Tools: Tools with Two Prong Plugs

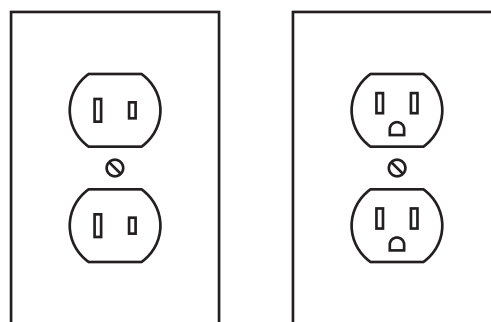

Outlets for 2-Prong Plug

NOTE: This Compact Belt Sander has a 2-Prong Grounded Plug.

1. Tools marked "Double Insulated" do not require grounding. They have a special double insulation system which satisfies OSHA requirements and complies with the applicable

standards of Underwriters Laboratories, Inc., the Canadian Standard Association, and the National Electrical Code. **(See Outlets for 2-Prong Plug.)**

- Double insulated tools may be used in either of the 120 volt outlets shown in the preceding illustration. **(See Outlets for 2-Prong Plug.)**

Extension Cords

- Grounded** tools require a three wire extension cord. **Double Insulated** tools can use either a two or three wire extension cord.
- As the distance from the supply outlet increases, you must use a heavier gauge extension cord. Using extension cords with inadequately sized wire causes a serious drop in voltage, resulting in loss of power and possible tool damage. **(See Table A.)**
- The smaller the gauge number of the wire, the greater the capacity of the cord. For example, a 14 gauge cord can carry a higher current than a 16 gauge cord. **(See Table A.)**
- When using more than one extension cord to make up the total length, make sure each cord contains at least the minimum wire size required. **(See Table A.)**
- If you are using one extension cord for more than one tool, add the nameplate amperes and use the sum to determine the required minimum cord size. **(See Table A.)**
- If you are using an extension cord outdoors, make sure it is marked with





the suffix “W-A” (“W” in Canada) to indicate it is acceptable for outdoor use.

- Make sure the extension cord is properly wired and in good electrical condition. Always replace a damaged extension cord or have it repaired by a qualified electrician before using it.
- Protect the extension cords from sharp objects, excessive heat, and damp or wet areas.

RECOMMENDED MINIMUM WIRE GAUGE FOR EXTENSION CORDS* (120/240 VOLT)					
NAMEPLATE AMPERES (at full load)	EXTENSION CORD LENGTH				
	25'	50'	75'	100'	150'
0 – 2.0	18	18	18	18	16
2.1 – 3.4	18	18	18	16	14
3.5 – 5.0	18	18	16	14	12
5.1 – 7.0	18	16	14	12	12
7.1 – 12.0	18	14	12	10	-
12.1 – 16.0	14	12	10	-	-
16.1 – 20.0	12	10	-	-	-

TABLE A * Based on limiting the line voltage drop to five volts at 150% of the rated amperes.

Symbology

	Double Insulated
	Canadian Standards Association
	Underwriters Laboratories, Inc.
	Volts Alternating Current
	Amperes

Symbology

n_0 xxxx/min.	No Load Revolutions per Minute (RPM)
-----------------	--------------------------------------

SPECIFICATIONS

Electrical Requirements	120V, 60 Hz 3.12 AMPS (No Load)
Motor No Load Speed	3600 RPM
Power Plug	2-Prong, Grounded
Belt Replacement Size	2-1/2" X 14"
Dust Collection Opening	1" Diameter

UNPACKING

When unpacking, make sure that the item is intact and undamaged. If any parts are missing or broken, please call Harbor Freight Tools at 1-800-444-3353 as soon as possible.

ASSEMBLY

No assembly is required for this Compact Belt Sander.

INSTRUCTIONS FOR PUTTING INTO USE



Read the **ENTIRE IMPORTANT SAFETY INFORMATION** section at the beginning of this manual including all text under subheadings therein before set up or use of this product.

WARNING

TO PREVENT SERIOUS INJURY

FROM ACCIDENTAL OPERATION:

Turn the Power Switch of the Compact Belt Sander to its "OFF" position and unplug the tool from its electrical outlet before inspecting, or making any adjustments.

Note: For additional information regarding the parts listed in the following pages, refer to the Assembly Diagram near the end of this manual.

OPERATING INSTRUCTIONS



Read the **ENTIRE IMPORTANT SAFETY INFORMATION** section at the beginning of this manual including all text under subheadings therein before set up or use of this Compact Belt Sander.

Tool Set Up

WARNING

TO PREVENT SERIOUS INJURY

FROM ACCIDENTAL OPERATION:

Turn the Power Switch of this Compact Belt Sander to its "OFF" position and unplug the tool from its electrical outlet before performing any inspection, maintenance, or cleaning procedures.

1. **Changing the Sanding Belt:**
 - a. Be sure the Compact Belt Sander is turned "OFF", and that it is unplugged from the power outlet.

- a. Rotate and position the Belt Release Lever (35) to its “UP” until the Follower Wheel (48) retracts and removes the tension on the Sanding Belt (38). See **Figure 1**.
- b. Slide off the old/worn belt.

NOTE: While the grit of the sanding belt may vary depending on what type of cutting results you need for your project, the size of the new belt should be identical to the belt being replaced: 2-1/2” Wide X 14” Long.

Figure 1

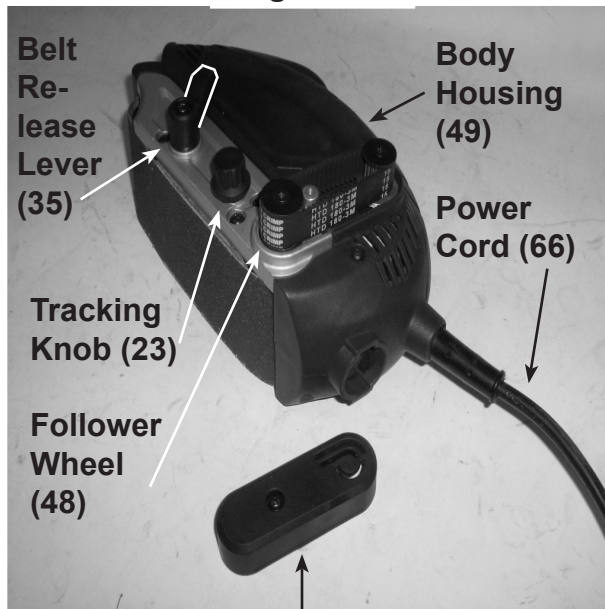

Drive Belt Cover (1)

- c. Slip a new belt around the Wheels (33 & 48) and slide on until the Wheels are covered.

NOTE: Sanding belts without directional arrows may face either direction (front or rear). If there are arrows printed on the inside of the sanding belt, make sure the arrows point in the direction of Wheel rotation. (Wheel rotation would be clockwise when you are looking into the open side of the Belt Sander).

WARNING! Severe laceration hazard!

If a directional sanding belt (one with arrows printed on the inside), is installed backwards, it may not track properly and may overhang the Body Housing (49) possibly causing severe lacerations,

- d. Rotate the Belt Release Lever (35) “Down” to reapply tension to the Sanding Belt (38). See **Figures 1 & 2**.

2. Tracking the Sanding Belt:

- a. Tracking should be done with the Compact Belt Sander running. The easiest way to accomplish this is to first turn “OFF” the Compact Belt Sander and unplug it from its power source.
- b. Turn the Compact Belt Sander upside down, place in a vise (not included) large enough to hold it securely, then plug it into a power source and turn it “ON”.

Figure 2

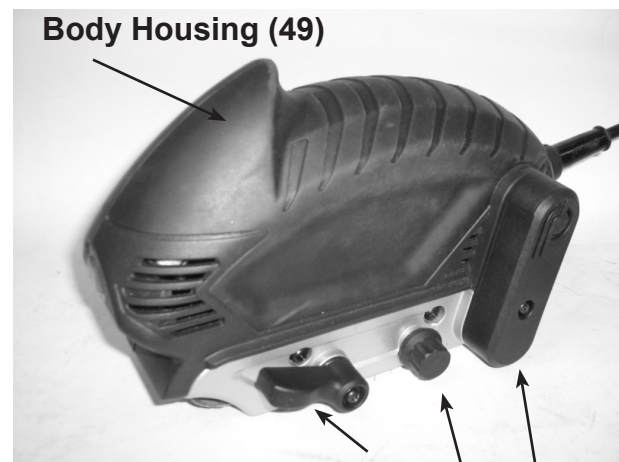

Body Housing (49)
Belt Release Lever (35)
Tracking Knob (23)
Drive Belt Cover (1)

- c. Turn the Tracking Knob (23) counterclockwise to move the sanding belt toward the Body Housing (49),

or turn the Tracking Knob (23) clockwise to move the sanding belt away from the Body Housing (49). See **Figures 1 & 2**.

- d. The sanding belt should be aligned with the flush outside edge of the Wheels while the Compact Belt Sander is in operation.
- e. Turn the Compact Belt Sander "OFF" and unplug it from the power source.
- f. Remove the Compact Belt Sander from the vise.

3. **Replacing the (small) Drive Motor Belt:**

- a. Be sure the Compact Belt Sander is turned "OFF", and that it is unplugged from the power outlet.

NOTE: For best results, place the Compact Belt Sander upside down in a vise to hold it securely while following this procedure.

- b. Using a Phillips head screwdriver (not included), remove the Drive Belt Cover (1).
- a. Rotate the Belt Release Lever (35) "UP" until the Follower Wheel (48) retracts and removes the tension on the Sanding Belt (38). See **Figure 1**.
- b. Slide off the Sanding Belt (38).
- c. Remove the Screws holding the Follower Wheel (48), and the Driver Wheel (33). Lift both Wheels up and out of the Compact Belt Sander. The (small) Drive Belt (2) will lift out also.
- d. Replace the worn/old Drive Belt (2) with a fresh/new Drive Belt (Part Number HTD 180-3M), and re-insert the two Wheels.

- e. Tighten the Screws holding both Wheels in place
- f. Rotate the Belt Release Lever (35) "DOWN" until the Follower Wheel (48) places tension back on the Sanding Belt (38).
- g. Remove the Compact Belt Sander from the Vise.

4. **Use of the Vacuum Adapter:**

- a. This Compact Belt Sander is equipped with a Hose Adapter/Vent Tube (67). It may be attached to both 1" (outside diameter) hose, and 7/8" (inside diameter) shop vacuum hose for dust collection as you work.
- b. The dust collection system should be emptied frequently (especially when sanding resin-coated surfaces such as polyurethane, varnish, and shellac, etc. Dispose of "coated" dust particles with coating manufacturer's guidelines, or place them inside a metal container with a tight metal lid. Remove "coated" dust particles from your premises daily. The accumulation of fine resin dust particles may self-ignite, causing a fire.
- c. **Do not use a dust collector when sanding metal.** *Doing so may create a fire hazard causing serious personal injury and/or damage to the Compact Belt Sander.*

Work Piece and Work Area Set Up

- 1. Designate a work area that is clean and well-lit. The work area must not allow access by children or pets to prevent distraction and injury.
- 2. Route the power cord along a safe route to reach the work area without creating a tripping hazard or exposing

the power cord to possible damage. The power cord must reach the work area with enough extra length to allow free movement while working.

3. There must not be objects, such as utility lines, nearby that will present a hazard while working.

General Operating Instructions

1. Make sure the Drive Belt Cover (1) is in place before turning on the Switch (68) to the Compact Belt Sander.
2. To reduce the risk of personal injury, make sure the Compact Belt Sander is not resting on the workpiece when the Switch (68) is turned "ON".
3. While this Compact Belt Sander may be held while in use with one hand, it is preferred (and recommended) that two hands are used for better control and safety. One hand should be placed on the rear section of the rubber portion of the Body Housing (49) and the other hand should hold the front section.
4. Secure loose work pieces using a vise or clamps (not included) to prevent movement while working.
5. When sanding wood workpieces, move the Compact Belt Sander as much as possible in the direction of the wood grain. This will help to prevent scratches across the grain. When not in use, always rest the tool on its side.
6. To prevent accidents, turn off the Compact Belt Sander and disconnect its power supply after use. Clean, then store the tool indoors out of the reach of children.

MAINTENANCE AND SERVICING



Procedures not specifically explained in this manual must be performed only by a qualified technician.

⚠️ WARNING

TO PREVENT SERIOUS INJURY

FROM ACCIDENTAL OPERATION:

Turn the Power Switch of the Compact Belt Sander to its "OFF" position and unplug the tool from its electrical outlet before performing any inspection, maintenance, or cleaning procedures.

TO PREVENT SERIOUS INJURY FROM TOOL FAILURE:

Do not use damaged equipment. If abnormal noise or vibration occurs, have the problem corrected before further use.

Cleaning, Maintenance, and Lubrication

1. **BEFORE EACH USE**, inspect the general condition of the Compact Belt Sander. Check for loose hardware, misalignment or binding of moving parts, cracked or broken parts, damaged electrical wiring, and any other condition that may affect its safe operation.
2. **AFTER USE**, wipe external surfaces of the tool with clean cloth. Use a shop vacuum and/or pressurized air to remove as much dust and debris from around the Wheels and sanding

belts as possible. If the tool is frequently used, it should be periodically checked and cleaned by a qualified service technician.

repair a damaged power cord, always replace.

3. Store inside away from the reach of children.
4. **▲WARNING! If the supply cord of this Compact Belt Sander is damaged, it must be replaced only by a qualified service technician. Never**

LIMITED 90 DAY WARRANTY

Harbor Freight Tools Co. makes every effort to assure that its products meet high quality and durability standards, and warrants to the original purchaser that this product is free from defects in materials and workmanship for the period of 90 days from the date of purchase. This warranty does not apply to damage due directly or indirectly, to misuse, abuse, negligence or accidents, repairs or alterations outside our facilities, criminal activity, improper installation, normal wear and tear, or to lack of maintenance. We shall in no event be liable for death, injuries to persons or property, or for incidental, contingent, special or consequential damages arising from the use of our product. Some states do not allow the exclusion or limitation of incidental or consequential damages, so the above limitation of exclusion may not apply to you. THIS WARRANTY IS EXPRESSLY IN LIEU OF ALL OTHER WARRANTIES, EXPRESS OR IMPLIED, INCLUDING THE WARRANTIES OF MERCHANTABILITY AND FITNESS.

To take advantage of this warranty, the product or part must be returned to us with transportation charges prepaid. Proof of purchase date and an explanation of the complaint must accompany the merchandise. If our inspection verifies the defect, we will either repair or replace the product at our election or we may elect to refund the purchase price if we cannot readily and quickly provide you with a replacement. We will return repaired products at our expense, but if we determine there is no defect, or that the defect resulted from causes not within the scope of our warranty, then you must bear the cost of returning the product.

This warranty gives you specific legal rights and you may also have other rights which vary from state to state.

3491 Mission Oaks Blvd. • PO Box 6009 • Camarillo, CA 93011 • (800) 444-3353

Troubleshooting

Problem	Possible Causes	Likely Solutions
Tool will not start.	<ol style="list-style-type: none"> 1. Cord not connected. 2. No power at outlet. 3. Internal damage or wear. (Carbon brushes or switch, for example.) 	<ol style="list-style-type: none"> 1. Check that cord is plugged in. 2. Check power at outlet. If outlet is un-powered, turn off tool and check circuit breaker. If breaker is tripped, make sure circuit is right capacity for tool and circuit has no other loads. 3. Have technician service tool.
Tool operates slowly.	Power being reduced by long or small diameter extension cord.	Eliminate use of extension cord. If an extension cord is needed, use one with the proper diameter for its length and load. See <i>Extension Cords</i> in <i>GROUNDING</i> section.
Performance decreases over time.	<ol style="list-style-type: none"> 1. Sanding belts worn and/or damaged. 2. Carbon brushes worn or damaged. 	<ol style="list-style-type: none"> 1. Keep sanding belts fresh with no worn or smooth areas. Replace as needed. 2. Have qualified technician replace brushes.
Excessive noise or rattling.	Internal damage or wear. (Carbon brushes or bearings, for example.)	Have technician service tool.
Overheating.	<ol style="list-style-type: none"> 1. Forcing sanding belts to work too fast. 2. Sanding Belt misaligned. 3. Sanding belts worn, or damaged. 4. Blocked motor housing vents. 5. Motor being strained by long or small diameter extension cord. 	<ol style="list-style-type: none"> 1. Allow tool to work at its own rate. 2. Check and correct alignment. 3. Keep sanding belts fresh. Replace as needed. 4. Wear ANSI-approved safety goggles and NIOSH-approved dust mask/respirator while blowing dust out of motor using compressed air. 5. Eliminate use of extension cord. If an extension cord is needed, use one with the proper diameter for its length and load. See <i>Extension Cords</i> in <i>GROUNDING</i> section.



Follow all safety precautions whenever diagnosing or servicing the tool. Disconnect power supply before service.

Record Product's Serial Number Here: _____

Note: If product has no serial number, record month and year of purchase instead.

Note: Some parts are listed and shown for illustration purposes only, and are not available individually as replacement parts.

PARTS LIST

Part	Description	Qty.
1	Drive Belt Cover	1
2	Drive Belt	1
3	Screw	2
4	Holder Plate	1
5	Drive Pulley	1
6	Retaining Ring	1
7	Small Roller Bearing	1
8	Gasket	1
9	Drive Pulley Puller Pin	1
10	Roller Bearing	2
11	Holder Plate	1
12	Spindle	1
13	Screw	7
14	Spring Washer	14
15	Gear Box Cover	1
16	Bearing	1
17	Bearing Box Cap	1
18	Screw	5
19	Gear	1
20	Flat Washer	7
21	Retaining Ring	1
22	Spline	1
23	Tracking Knob	1
24	Spring	1
25	Tracking Knob Collar	1
26	Screw	5
27	Spring Washer	5
28	Flat Washer	5
29	Trigger	1
30	Trigger Locating Ring	1
31	Center Bracket	1
32	Driver Wheel Rubber Ring	1
33	Driver Wheel	1
34	Camshaft	1
35	Belt Release Lever	1

Part	Description	Qty.
36	Base Plate	1
37	Belt Release Lever Holder	1
38	Sanding Belt (2-1/2" X 14")	1
39	Spring Cap	1
40	Small Spring	1
41	Plastic Cap	1
42	Spring Locating Plate	1
43	Big Spring	1
44	Driver Wheel Bracket	1
45	Retaining Ring	1
46	Follower Wheel Pin	1
47	Follower Wheel Brush	1
48	Follower Wheel	1
49	Body Housing	1
50	Self-Tapping Screw	5
51	Rubber Ring	1
52	Bearing	1
53	Self-Tapping Screw	2
54	Orifice Plate	1
55	Rotor	1
56	Self-Tapping Screw	2
57	Stator	1
58	Motor Housing	1
59	Brush Holder (Plastic)	1
60	Brush Holder	2
61	Brush	2
62	Helicoid Spring	2
63	Bearing	1
64	Rubber Ring	1
65	Self Taping Screw	1
66	Power Cord (2-Prong Plug)	1
67	Hose Adaptor/Vent Tube	1
68	Switch	1
69	Switch Dust Shield	1

PLEASE READ THE FOLLOWING CAREFULLY

THE MANUFACTURER AND/OR DISTRIBUTOR HAS PROVIDED THE PARTS LIST AND ASSEMBLY DIAGRAM IN THIS MANUAL AS A REFERENCE TOOL ONLY. NEITHER THE MANUFACTURER OR DISTRIBUTOR MAKES ANY REPRESENTATION OR WARRANTY OF ANY KIND TO THE BUYER THAT HE OR SHE IS QUALIFIED TO MAKE ANY REPAIRS TO THE PRODUCT, OR THAT HE OR SHE IS QUALIFIED TO REPLACE ANY PARTS OF THE PRODUCT. IN FACT, THE MANUFACTURER AND/OR DISTRIBUTOR EXPRESSLY STATES THAT ALL REPAIRS AND PARTS REPLACEMENTS SHOULD BE UNDERTAKEN BY CERTIFIED AND LICENSED TECHNICIANS, AND NOT BY THE BUYER. THE BUYER ASSUMES ALL RISK AND LIABILITY ARISING OUT OF HIS OR HER REPAIRS TO THE ORIGINAL PRODUCT OR REPLACEMENT PARTS THERETO, OR ARISING OUT OF HIS OR HER INSTALLATION OF REPLACEMENT PARTS THERETO.

ASSEMBLY DIAGRAM

