



OPERATING INSTRUCTIONS AND OWNER'S MANUAL

Model #

MH9BX

READ INSTRUCTIONS CAREFULLY: Read and follow all instructions. Place instructions in a safe place for future reference. Do not allow anyone who has not read these instructions to assemble, light, adjust or operate the heater.

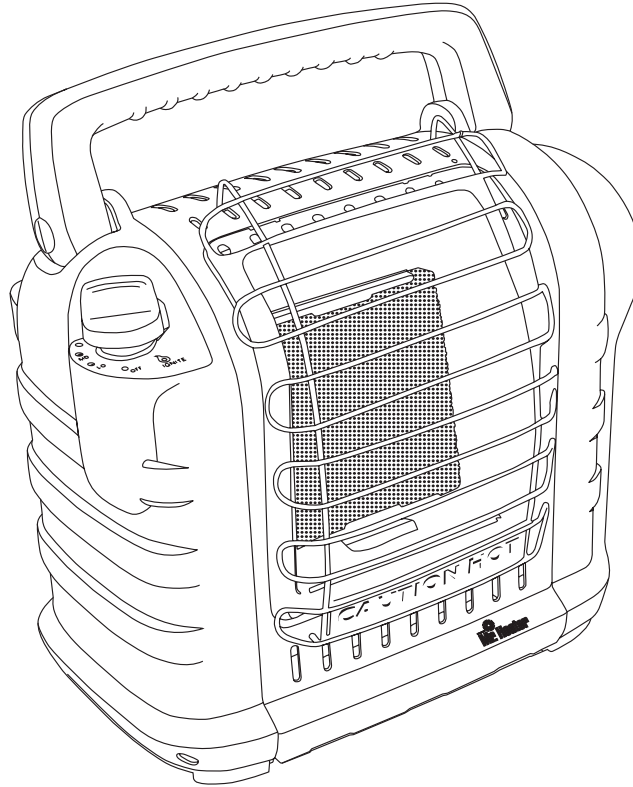

PORTABLE PROPANE HEATER FOR RECREATIONAL AND COMMERCIAL USE

WARNING: If the information in this manual is not followed exactly, a fire or explosion may result causing property damage, personal injury or loss of life.

- Do not store or use gasoline or other flammable vapors and liquids in the vicinity of this or any other appliance.
- An LP cylinder not connected for use shall not be stored in the vicinity of this or any other appliance.
- WHAT TO DO IF YOU SMELL GAS
 - Do not try to light appliance.
 - Extinguish any open flame.
 - Shut off gas to appliance.
- Service must be performed by a qualified service agency.

This is an unvented gas-fired portable heater. It uses air (oxygen) from the area in which it is used. Adequate combustion and ventilation air must be provided. Refer to page 3.

WARNING:

⚠ Every time hose or tank is connected to unit, connection must be checked for leaks in one or more ways: Apply soapy water to connection, look for bubbles, listen for hiss of escaping gas, feel for extreme cold, smell for rotten egg odor. Do not use if leaking!

WARNING:

⚠ Any changes to this heater or its controls can be dangerous.

WARNING:

⚠ Early signs of carbon monoxide poisoning resemble the flu, with headache, dizziness and/or nausea. If you have these signs, heater may not be working properly. Get fresh air at once! Have heater serviced.

WARNING:

⚠ If the recreational or commercial enclosure does not have a window or roof vent, DO NOT USE THIS HEATER INSIDE.

THE STATE OF CALIFORNIA REQUIRES THE FOLLOWING WARNING:

WARNING:

Combustion by-products produced when using this product contain carbon monoxide, a chemical known to the State of California to cause cancer and birth defects (or other reproductive harm).

CONTENTS

General Safety Instructions	2
Odor Fade Warning	3
General Information.....	4
Operating with Disposable Propane Cylinders	4
Operating With Hose Connected to Remote Cylinder	5
Maintenance.....	6
Troubleshooting	6
Parts List.....	7
Parts Ordering Information	8
Service Information.....	8

SPECIFICATIONS

MODEL NO.	MH9BX
GAS TYPE.....	PROPANE
INPUT BTU/HR.....	4,000 / 9,000

CLEARANCE TO COMBUSTIBLES

TOP	30"
FRONT.....	24"
SIDES	6"
REAR.....	0"

Caution: Some carpets or linoleum surfaces may discolor if heater is placed directly on these floor coverings.

GENERAL SAFETY INSTRUCTIONS

THIS IS A HEATING APPLIANCE. DO NOT OPERATE THIS APPLIANCE WITHOUT THE FRONT WIRE GUARD INSTALLED

- Due to high temperatures, the appliance should be located out of traffic and away from combustible materials.
- Children and adults should be alerted to the hazard of high surface temperatures and should stay away to avoid burns or clothing ignition.
- Young children should be carefully supervised when they are near the appliance.
- Do not place clothing or other flammable material on or near the appliance.
- Do not operate heater in any moving vehicle.
- This heater can only be used in a recreational or commercial enclosure with a window or roof vent. It may also be used outdoors.
- This heater requires a vent area of 9 square inches (example 3" x 3" opening) minimum for adequate ventilation during operation. Do not use other fuel burning appliances inside.
- GAS PRESSURE AT HEATER IS REGULATED AND FIXED AT 11" W.C. WHEN USING A REMOTE HOSE CONNECTION DO NOT REGULATE OR REDUCE PROPANE TANK SUPPLY PRESSURE TO HEATER!
- REGULATOR IN HEATER MUST ALWAYS BE IN PLACE DURING OPERATION.
- If the wire guard is removed for servicing, it must be replaced prior to operating the heater.
- The appliance should be inspected before each use. Frequent cleaning may be required. The control com-

partments, burner and circulating air passageways of the appliance must be kept clean, see MAINTENANCE.

- DO NOT use this heater if any part has been under water. Immediately call a qualified service technician to inspect the heater and to replace any part of the control system and any gas control, which has been under water.
- When used without adequate combustion and ventilation air, this heater may give off excessive CARBON MONOXIDE, an odorless, poisonous gas.
- Some people - pregnant women, persons with heart or lung disease, anemia, those under the influence of alcohol, those at high altitudes - are more affected by carbon monoxide than others.
- When heater is placed on the ground, make sure the ground is level and keep any objects at least 24 inches from the front of the heater. THIS HEATER IS EQUIPPED WITH A TIP OVER SWITCH THAT WILL SHUT THE HEATER OFF IF THE HEATER TIPS OVER HOWEVER, DO NOT LEAVE HEATER UNATTENDED OR WHERE CHILDREN MAY CAUSE THE HEATER TO TIP OVER. NEVER OPERATE THE HEATER WHILE SLEEPING!

ODOR FADE WARNING

WARNING

Asphyxiation Hazard

- Do not use in unventilated areas.
- The flow of combustion and ventilation air must not be obstructed.
- Proper ventilation air must be provided to support the combustion air requirements of the heater being used.
- Refer to the specification section of the heater's manual, heater dataplate, or contact the factory to determine combustion air ventilation requirements of the heater.
- Lack of proper ventilation air will lead to improper combustion.
- Improper combustion can lead to carbon monoxide poisoning leading to serious injury or death. Symptom of carbon monoxide poisoning can include headaches, dizziness and difficulty in breathing.

FUEL GAS ODOR

LP gas and natural gas have man-made odorants added specifically for detection of fuel gas leaks.

If a gas leak occurs you should be able to smell the fuel gas. Since Propane (LP) is heavier than air you should smell for the gas odor low to the floor. ANY GAS ODOR IS YOUR SIGNAL TO GO INTO IMMEDIATE ACTION!

- Do not take any action that could ignite the fuel gas. Do not operate any electrical switches. Do not pull any power supply or extension cords. Do not light matches or any other source of flame. Do not use your telephone.

- Get everyone out of the building and away from the area immediately.
- Close all propane (LP) gas tank or cylinder fuel supply valves, or the main fuel supply valve located at the meter if you use natural gas.
- Propane (LP) gas is heavier than air and may settle in low areas. When you have reason to suspect a propane leak, keep out of all low areas.
- Use your neighbor's phone and call your fuel gas supplier and your fire department. Do not re-enter the building or area.
- Stay out of the building and away from the area until declared safe by the firefighters and your fuel gas supplier.
- FINALLY, let the fuel gas service person and the firefighters check for escaped gas. Have them air out the building and area before you return. Properly trained service people must repair any leaks, check for further leakages, and then relight the appliance for you.

ODOR FADING - NO ODOR DETECTED

- Some people cannot smell well. Some people cannot smell the odor of the man-made chemical added to propane (LP) or natural gas. You must determine if you can smell the odorant in these fuel gases.
- Learn to recognize the odor of propane (LP) gas and natural gas. Local propane (LP) gas dealers will be more than happy to give you a scratch and sniff pamphlet. Use it to become familiar with the fuel gas odor.
- Smoking can decrease your ability to smell. Being around an odor for a period of time can affect your sensitivity to that particular odor. Odors present in animal confinement buildings can mask fuel gas odor.
- **The odorant in propane (LP) gas and natural gas is colorless and the intensity of its odor can fade under some circumstances.**
- If there is an underground leak, the movement of gas through the soil can filter the odorant.
- Propane (LP) gas odor may differ in intensity at different levels. Since Propane (LP) gas is heavier than air, there may be more odor at lower levels.
- **Always be sensitive to the slightest gas odor.** If you continue to detect any gas odor, no matter how small, treat it as a serious leak. Immediately go into action as discussed previously.

ATTENTION - CRITICAL POINTS TO REMEMBER!

- Propane (LP) gas has a distinctive odor. Learn to recognize these odors. (Reference Fuel Gas Odor and Odor Fading sections above.)
- Even if you are not properly trained in the service and repair of the heater, ALWAYS be consciously aware of the odors of propane (LP) gas and natural gas.
- If you have not been properly trained in repair and service of propane (LP) gas then do not attempt to light heater, perform service or repairs, or make any adjustments to the heater on the propane (LP) gas fuel system.

- A periodic sniff test around the heater or at the heater's joints; i.e. hose, connections, etc., is a good safety practice under any conditions. If you smell even a small amount of gas, CONTACT YOUR FUEL GAS SUPPLIER IMMEDIATELY. DO NOT WAIT!

GENERAL INFORMATION:

- This heater is safe for indoor use in small recreational enclosures having means for providing combustion air and ventilation, such as enclosed porches, cabins, fishing huts, trailers, tent trailers, tents, truck caps and vans. It may be used for emergency indoor heating when connected to a disposable 1-lb. propane cylinder and for indoor use in commercial enclosures, having means for providing combustion air and ventilation, such as construction trailers or temporary work enclosures.

Note: The heater can be used outdoors, but may experience nuisance shutoffs due to certain wind conditions.

- When the heater is cold or at room temperature, it will take a few minutes for the burner tile to turn bright orange. This is normal and the heater is working properly. If burner tile is visibly flaming, turn heater off and call a qualified service technician.
- When the unit is lit, there should be about a quarter inch (1/4") border around the tile that will not turn bright orange. This is normal.
- When operating the heater for the first time, the top area of the reflector may discolor. This is also normal and is no reason for concern.
- The protective grill on the front of this heater is coated with a special high-temperature resistant paint. When the heater is used for the first time, the grill may give off noticeable smoke or fumes. This is normal and will not occur during subsequent uses. The fumes are not harmful.
- When operating the heater at altitudes over 7,000 FT. above sea level, the unit may not burn as bright as in lower altitudes. This is normal. At higher altitudes, the heater may shut-off. If this happens, provide fresh air, wait 5 minutes and re-light. Due to local atmospheric conditions heater may not re-light.
- Operating time will vary depending on the heater setting and the supply cylinder size. Up to 3 to 6 hours on a 1 lb. cylinder. Up to 48 to 110 hours on a 20 lb. cylinder (based on "HI" and "LO" settings).
- When moving heater when lit or bumping heater setting it down, tip over switch may shut off heater. If this happens, re-light.
- Due to natural operation of small tanks, condensation may build up on tank and drip on surface under heater.

LIGHTING / OPERATING INSTRUCTIONS FOR USE WITH DISPOSABLE 1 LB. PROPANE CYLINDERS:

WARNING: Always inspect propane cylinder and heater propane connections for damage, dirt, and debris before attaching

propane cylinder. Do not use if head of cylinder is damaged, punctured or deteriorated. ALWAYS ATTACH OR DETACH CYLINDER OUTDOORS AWAY FROM FLAMES, OTHER IGNITION SOURCES, AND ONLY WHEN HEATER IS COOL TO TOUCH. NEVER SMOKE WHEN ATTACHING OR REMOVING PROPANE CYLINDER OR MAKING REMOTE CONNECTIONS!

- Use only LP-gas cylinders marked in accordance with the U.S. Dept. of Transportation (DOT).
- Use only 16.4 oz. (1 lb.) disposable cylinders that mate with No. 600 valve connection.

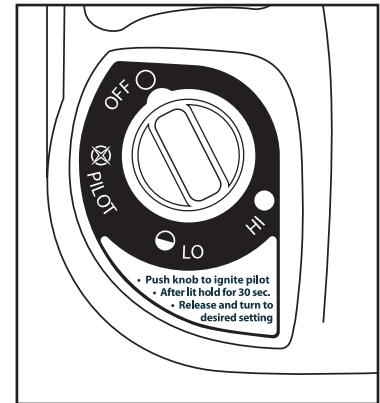

Figure 1: "Off" position.

- Heater and attached cylinder must be in an upright position during operation.
- Make sure four-position Control Knob is in "OFF" position; see Figure 1.
- Swivel regulator outward for easy tank installation. Screw 1 lb. disposable LP-gas supply cylinder clockwise (from bottom) into portable heater until hand-tight; see Figure 2.

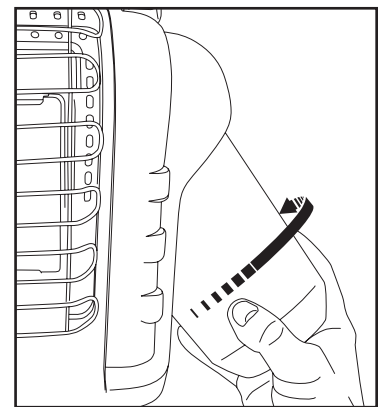

Figure 2: Attach fuel tank

- Check cylinder connection for leaks with soapy water at the threaded connection under the domed plastic cover where the cylinder screws into the regulator. SEE WARNING! ON DOMED PLASTIC COVER.
- Turn Control Knob counterclockwise to "PILOT" position and depress to light; see Figure 3.

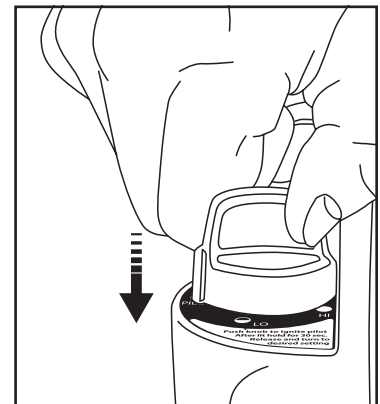

Figure 3: Ignition

- If heater does not light, hold down for approximately 30 seconds; release and depress again. Repeat until pilot lights.
- After pilot lights, hold down for 30 -60 seconds and then release knob. Knob should return to fully extended position; see Figure 4. To operate heater slightly depress knob and gently turn to lock in the "HI" position to light

burner tile. Leave on "HI" position until burner tile turns bright orange.

- After burner tile has turned bright orange, adjust heat output by turning Control Knob to desired position ("LO" or "HI" setting)

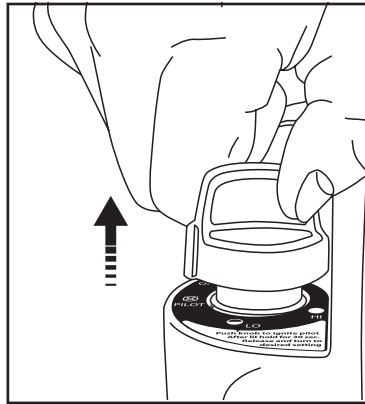

Figure 4: Release knob.

Warning:

⚠ DO NOT OPERATE HEATER UNLESS CONTROL KNOB IS LOCKED IN A POSITION MARKED "HI", "LO" or "PILOT". NEVER SET CONTROL KNOB BETWEEN LOCKED POSITIONS. POOR COMBUSTION AND HIGHER LEVELS OF CARBON MONOXIDE MAY RESULT.

- To shut off heater, slightly push down and turn Control Knob clockwise to "OFF" position.
- **CAUTION:** After turning heater off, wire guard will remain hot. Allow to thoroughly cool before storing.
- Do not operate, store or remove cylinder near flammable items or ignition sources.
- LP-GAS CYLINDERS MUST BE DISCONNECTED FROM HEATER WHEN NOT IN USE!

LIGHTING / OPERATING INSTRUCTIONS FOR USE WITH HOSE CONNECTED TO A REMOTE CYLINDER, MAXIMUM SIZE 20 LBS:

- This Heater may be used in a recreational enclosure or temporary construction work enclosure with a remote refillable propane cylinder ONLY when the cylinder is located outdoors and the Heater is used with Mr. Heater Hose No. F273701, F273702 or F272702 and fuel filter F273699. Fuel filter must be replaced annually. (NOTE: Do not operate without the fuel filter as fuel contamination may damage the heater.) Or use green F273704 Buddy series hose. Fuel filter not required.
- **DANGER:** NEVER bring a refillable propane cylinder indoors. A fire or explosion can occur causing property damage, serious injury or death!
- Inspect the hose before each use of the heater. If there is excessive abrasion or wear, or the hose is cut, replace prior to using the heater with one of the Mr. Heater Hose No.'s. shown above.
- The propane cylinder must include a listed overfilling protection device as well as a collar to protect the cylinder valve.
- Heater must be in an upright position during operation.
- Make sure four-position Control Knob is in "OFF" position; see Figure 1, at left.
- Swivel regulator outward for easy hose installation.

Screw hose connector into regulator on heater and screw connector on other end of hose into LP-gas supply cylinder valve. Tighten all hose connections.

- Mr. Heater strongly recommends using disposable fuel filter F273699 to trap any oil substances when connected to a remote cylinder that can make heater inoperable.
- Open valve at LP-gas supply cylinder.
- Check all hose connections for leaks with soapy water at the threaded connection under the domed plastic cover where the hose connector screws into the regulator and at LP-gas supply cylinder. SEE WARNING!
- Turn Control Knob counterclockwise to "PILOT" position and depress to light; see Figure 3. This may take longer to purge air from the supply hose depending on the length of the hose being used.
- If pilot does not light, hold down for approximately 30 seconds; release and depress again. Repeat until pilot lights.
- After pilot lights, hold down for 30 -60 seconds and then release knob. Knob should return to fully extended position; see Figure 4. The pilot should remain lit. To operate heater slightly depress knob and gently turn to lock in the "HI" position to light burner tile. Leave on "HI" position until burner tile turns bright orange.
- After burner tile has turned bright orange, adjust heat output by turning Control Knob to desired position ("LO" or "HI" setting).

⚠ Caution: Do not try to adjust heating levels by using the propane tank shut off valve.

Warning:

⚠ DO NOT OPERATE HEATER UNLESS CONTROL KNOB IS LOCKED IN A POSITION MARKED "HI", "LO" or "PILOT". NEVER SET CONTROL KNOB BETWEEN LOCKED POSITIONS. POOR COMBUSTION AND HIGHER LEVELS OF CARBON MONOXIDE MAY RESULT.

- **To shut off heater, shut off propane at supply tank, allow heater to use-up propane in supply line until heater shuts off, then slightly push down and turn Control Knob clockwise to "OFF" position.**
- **CAUTION:** After turning heater off, wire guard will remain hot. Allow to thoroughly cool before storing.
- When not in use, the gas must be turned off at the LP-gas supply cylinder. As stated before allow heater to use up propane in supply line until heater shuts off. When the LP-gas supply cylinder is not disconnected from the heater, the heater and the cylinder must be stored outdoors, in a well ventilated space, out of reach of children, and must not be stored in a building, garage or any other enclosed area.
- Indoor storage of the heater is permissible only if the cylinder is disconnected and removed from the heater. Cylinders must be stored outdoors out of the reach of children and must not be stored in a building, garage or any other enclosed area.

MAINTENANCE:

Always keep the heater area clear and free from combustible materials, gasoline and other flammable vapors and liquids.

Keep the vent areas (slots in the bottom and the top at the front and rear of heater) clear at all times.

Visually inspect the pilot flame and burner periodically during use. The pilot flame should be blue in color (not yellow) and will extend beyond the thermocouple. The flame will surround the thermocouple just below the tip, see Figure 5.

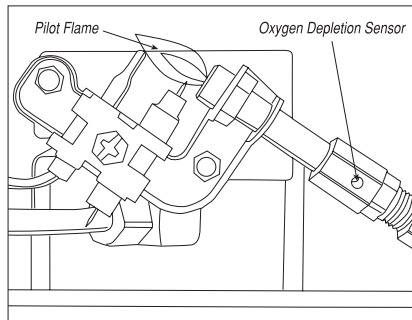

Figure 5

A slight yellow flame may occur where the pilot flame and main burner flame meet. The burner should be bright orange (with a slight blue color around the border, a red-orange haze that is visible on the ceramic tile is acceptable) and without a noticeable flame. A blue flame that rolls out at the top of the ceramic tile indicates an accumulation of dust, lint or spider webs inside the casing assembly and main burner assembly. If the pilot is yellow or the burner has a noticeable flame, cleaning may be required. Use the following procedure to inspect the casing assembly and main burner assembly.

It is necessary to periodically check the burner orifice and burner venturi tube to make sure they are clear of insects/nests or spider webs that may accumulate over time. A clogged tube can lead to a fire.

- 1 Allow heater to thoroughly cool before performing any maintenance.
- 2 Remove disposable 1 lb. cylinder from heater or turn OFF gas supply at remote cylinder valve, and disconnect hose from heater.
- 3 Remove (4) four screws that secure the rear cover to the Heater.
- 4 Pivot cover outward from bottom. Release from 2 top clips. Set aside.
- 5 Remove (4) four burner retaining screws and fuel line from burner assembly. Remove burner assembly from back of housing.
- 6 Inspect interior of housing for accumulation of dust, lint or spider webs. If necessary, clean interior housing with a vacuum cleaner or apply air pressure. Do not damage any components within the housing assembly when you are cleaning.
- 7 Inspect and clean main burner orifice (threaded into orifice holder). Orifice holder is attached to the burner

assembly venturi with (2) two screws.

- 8 Inspect and clean pilot (mounted to bracket) by using a vacuum or apply air pressure through the holes in the pilot indicated by the arrows in Figure 5.
WARNING: Never use needles, wires, or similar cylindrical objects to clean the pilot to avoid damaging the calibrated orifice that controls the gas flow.
- 9 Apply air pressure (max. 30 psi.) into ceramic tile of burner assembly and the venturi tube (ref. item #17) to remove dust, lint or spider webs.
- 10 Reassemble main burner orifice holder onto the burner assembly.
- 11 Reinstall burner assembly into the heater housing.
- 12 Reinstall fuel line and check for leaks.
- 13 Install heater back cover.

TROUBLESHOOTING INFORMATION:

If Spark electrode does not produce spark.

CHECK

- Spark electrode broken – replace ODS (Oxygen Depletion Sensor).
- Igniter wire may not be attached to spark electrode.
- Igniter wire damaged – replace.
- Piezo igniter defective – replace control valve.

If Spark electrode produces spark but pilot does not light.

CHECK

- No gas to heater – install disposable cylinder or connect hose and filter where required and turn on valve at remote cylinder.
- "PILOT" position not properly aligned – turn gas control knob to "PILOT" position and depress.
- Pilot is blocked from spider web or dirt – clean pilot, see MAINTENANCE.

If Pilot flame does not stay lit when knob is released.

CHECK

- Control knob in "PILOT" position not completely depressed or held in long enough to purge air from lines.
- Pilot flame not surrounding thermocouple – clean pilot, see MAINTENANCE.
- Pilot Assembly defective – replace.
- Tip switch wires disconnected – connect.

If Main burner does not ignite.

CHECK

- Main burner orifice is blocked – clean burner, see MAINTENANCE.

If Heater keeps shutting "OFF" during normal operation.

CHECK

- Pilot is blocked – clean pilot, see MAINTENANCE.
- Provide minimum fresh air opening of 9 square inches (example 3" x 3" opening).
- Tip over switch activated from bumping heater. Re-light.
- Regulator defective - Replace regulator.
- Internal contamination - Replace control valve and regulator.
- Call Technical Services for additional information.

Mr. Heater • Portable Propane Heater • Model # MH9BX

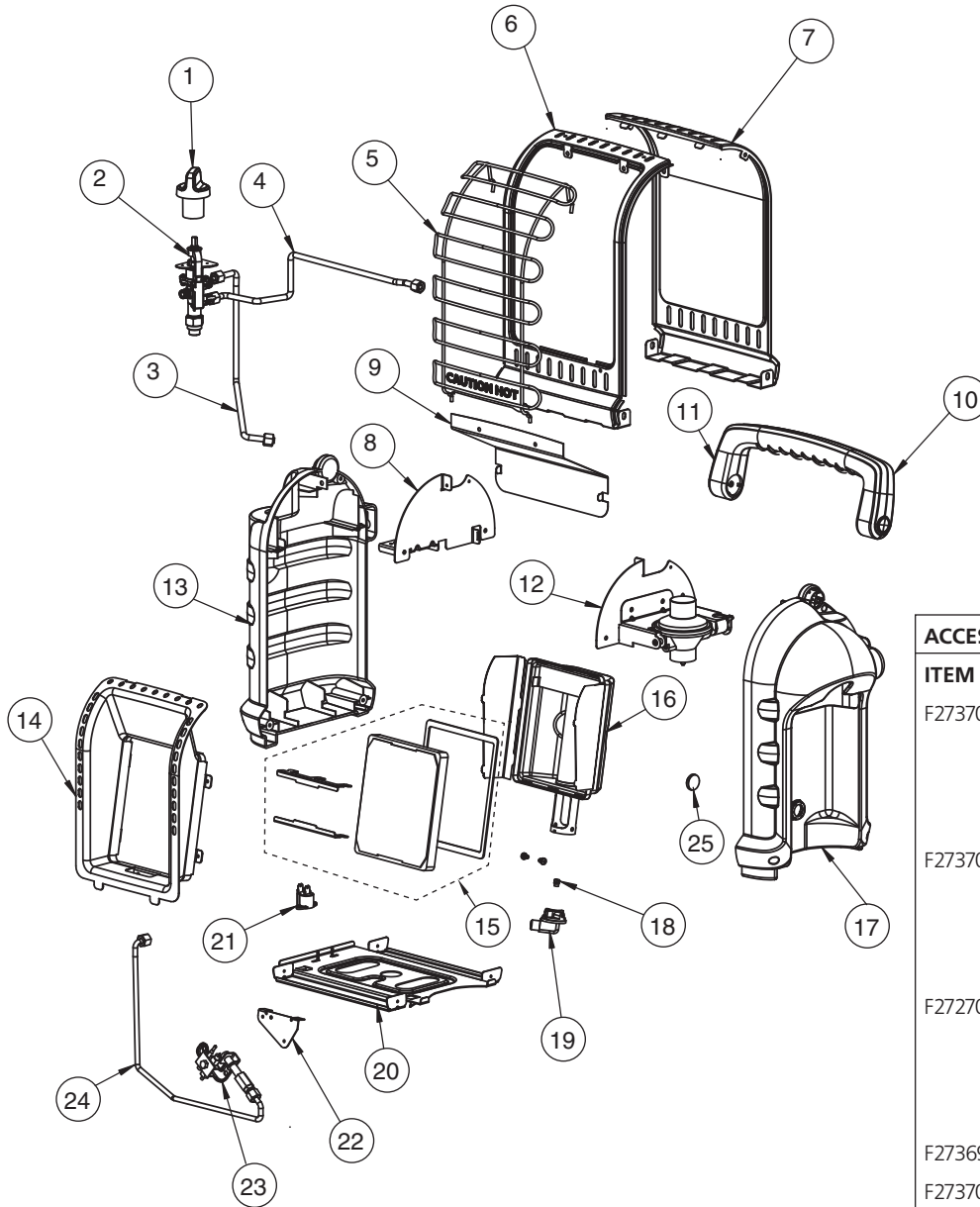

ACCESSORIES:

ITEM #	DESCRIPTION
F273701	5 ft. PROPANE HOSE ASSEMBLY (Swivel 1"-20 Male Throwaway Cyl. Thd. X P.O.L. w/Handwheel) (Recommended use with fuel filter.)
F273702	12 ft. PROPANE HOSE ASSEMBLY (Swivel 1"-20 Male Throwaway Cyl. Thd. X P.O.L. w/Handwheel) (Recommended use with fuel filter.)
F272702	12 ft. PROPANE HOSE ASSEMBLY (Swivel 1"-20 Male Throwaway Cyl. Thd. X P.O.L. w/Handwheel) (Recommended use with fuel filter.)
F273699	Fuel Filter (Replace Annually)
F273704	10 ft. BUDDY-SERIES HOSE ASSEMBLY (Fuel filter not required)

REPLACEMENT PARTS LIST:

No.	Part#	Description	No.	Part#	Description	No.	Part#	Description
1.	32017	Knob, Valve, Safety, Red	8.	32027	Brkt, Valve	17.	33090	Housing, Right, Plastic, Gray
	32019	Knob, Valve, Safety, Green	9.	32028	Heat, Shield		33091	Housing, Right, Plastic, Black
2.	32054	Valve, Assy, Control	10.	32015	Handle, Back, Plastic, Gray	18.	32068	Orifice, Assy with O-Ring
3.	32056	Tube, Burner, Main		32074	Handle, Back, Plastic, Black	19.	32052	Orifice, Holder
4.	32053	Tube, Inlet, Assy	11.	32014	Handle, Front, Plastic, Gray	20.	32023	Floor, Panel, Metal
5.	32051	Guard, Wire		32072	Handle, Front, Plastic, Black	21.	73403	Switch, Tipover
	32061	Guard, Wire, Heavy	12.	75198	Assy, Regulator, w/Support	22.	32046	Brkt, ODS (Oxygen Depletion Sensor)
6.	33092	Panel, Front, Metal, Red	13.	32080	Housing, Left, Plastic, Gray	23.	73404	ODS, Pilot, Assy
	33094	Panel, Front, Metal, Yellow		32085	Housing, Left, Plastic, Black	24.	32057	Tube, Pilot, Assy
	33093	Panel, Front, Metal, Green	14.	32021	Reflector, Metal	25.	32067	Magnet, Tank
7.	75191	Panel, Back, Metal, w/32004, Red	15.	33088	Tile, Replacement Kit, MH9BX			
	75194	Panel, Back, Metal, w/32004, Yellow	16.	32032	Burner, Assy			
	75196	Panel, Back, Metal, w/32004, Green						



OPERATING INSTRUCTIONS AND OWNER'S MANUAL

Model #

MH9BX

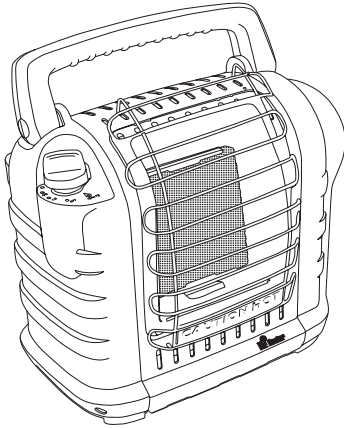

Heaters with Starting Serial#

MHC-320000000001

MHC-320100000001

MHC-320200000001

MHC-320400000001

MHC-320600000001

WARNING:

USE ONLY MANUFACTURER'S REPLACEMENT PARTS. USE OF ANY OTHER PARTS COULD CAUSE INJURY OR DEATH. REPLACEMENT PARTS ARE ONLY AVAILABLE DIRECT FROM THE FACTORY AND MUST BE INSTALLED BY A QUALIFIED SERVICE AGENCY. MR. HEATER HOSES F273701, F273702 AND F272702 ARE SPECIFICALLY DESIGNED FOR USE WITH THIS HEATER ALONG WITH F273699 DISPOSABLE FUEL FILTER (REPLACE ANNUALLY) OR HOSE F273704 (FILTER NOT REQUIRED). USE OF OTHER HOSES MAY CAUSE THE HEATER TO BECOME INOPERABLE.

PARTS ORDERING INFORMATION:

PURCHASING: Accessories may be purchased at any Mr. Heater local dealer or direct from the factory

FOR INFORMATION REGARDING SERVICE

Please call Toll-Free 800-251-0001
www.mrheater.com

Our office hours are 8:30 AM – 5:00 PM, EST, Monday through Friday.

Please include the model number, date of purchase, and description of problem in all communication.

LIMITED WARRANTY

Mr. Heater, Inc. warrants its heaters and accessories to be free from defects in material and workmanship for a period of 1 year from date of purchase. Mr. Heater, Inc. will repair or replace this product free of charge if it has been proven to be defective within the 1-year period, and is returned at customer expense with proof of purchase to Mr. Heater, Inc. within the warranty period.

Mr. Heater, Inc. reserves the right to make changes at any time, without notice or obligation, in colors, specifications, accessories, materials and models.

MR. HEATER, INC., 4560 W. 160TH ST., CLEVELAND, OHIO 44135 • 800-251-0001
Mr. Heater and Portable Buddy are registered trademarks of Enerco Group, Inc.
© 2009, Enerco/Mr. Heater. All rights reserved



CSA 4.98
U.S.