

Official Worldwide Olympic Partner



50 Hz

2008/4

Multi-Format Camera

**AK-HC3500**

*Powerful multi-format digital camera with a new  
IT-3CCD delivering 1080i native resolution*



# High image quality, easy operation and outstanding reliability from a new generation HD multi-format camera



The AK-HC3500 is the zenith of advanced camera design. In addition to a unique 2/3-inch IT-3CCD and spatial offset processing technologies, it offers a newly-developed 14-bit A/D converter and 38-bit Digital Signal Processing LSI for exceptional image quality. To satisfy the demands of shooting in the field, it also features an ergonomic design for easier, more comfortable use. Add to this outstanding performance, and you have the ideal studio and field multi-format camera for the high definition era.

## Switchable output HD/SD formats

The AK-HC3500's multi-format capability makes it perfect for demanding broadcasts and program production at home and abroad. Using the optional down converter board also enables HD to SD signal (480i/576i) conversion.

Compatible formats	<b>HD</b>	1080/59.94i, 1080/50i
	<b>SD (option)</b>	480/59.94, 576/50i

## Panasonic's unique high sensitivity, low smear 2/3-inch 2.2-megapixel IT-3CCD

Panasonic CCD sensor technology and the improved on-chip lens performance offers a high sensitivity of F10 (1080/59.94i) /F11 (1080/50i) at 2 000 lx, a low smear level and an excellent signal to noise ratio of 60 dB.



CCD/prism assembly

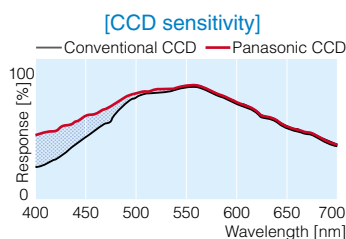

Blue channel sensitivity has been improved approximately 3 dB to achieve a better response ratio. Even deep-blue colors can be reproduced with vivid chrominance and significantly reduced noise.

Panasonic's single-channel transfer system and spatial-offset processing technologies improve signal modulation depth and reduce moire.

Output signal gain without spatial-offset processing      Output signal gain with spatial-offset processing

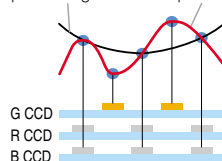

With spatial-offset processing, green samples are offset, allowing motion in the object to be more faithfully reproduced.

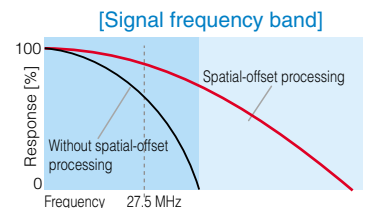

With spatial-offset processing, the depth of modulation of high-frequency signals is greatly improved.

# 14-bit A/D converter and latest 38-bit Digital Signal Processing (DSP) provide clear, sharp images from dark to bright areas.

A/D conversion is 14-bit compared to conventional 12-bit. There's also a newly-developed 38-bit Digital Signal Processing (DSP) and Panasonic's original real-time gamma correction to enable high quality images with Dynamic Range Stretch (DRS) and other high-performance functions.

## Dynamic Range Stretch (DRS) Function

DRS helps assure high image quality when shooting extremely contrasty scenes. It's also effective when shooting standard scenes because it avoids aliasing (knee artifacts) which can be unattractive for on-screen talent.

### Before correction

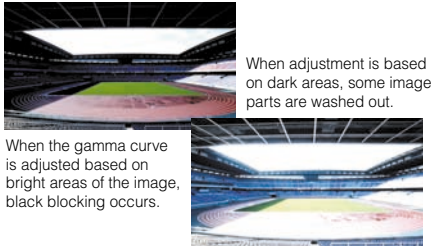

### After correction



Clear, sharp reproduction of both bright and dark areas.

## Cine Gamma Curve

Thanks to its cine gamma curve, the AK-HC3500 can produce pictures with the same kind of tonal beauty, natural gradation, and rich colors you get with film recordings.



TV



Movies

## Color Correction

The 12-vector variable masking circuit allows precise and independent hue and saturation adjustment of individual colors.



\* Color correction restricted to the red colors.

## Skin Tone Detail Correction

Separately defocusing two skin tones helps tone down wrinkles and dull areas to produce beautiful, naturally textured results when shooting people. And since defocusing is possible throughout the entire hue phase (360°), defocusing can also be applied for colors other than skin tones.



Beautiful results with fewer wrinkles and other blemishes

## Enhanced DTL Signal Processing

Enhanced DTL signal processing ensures superb picture quality with minimal noise in horizontal and vertical directions, as well as in the image's dark and brightly lit areas.



Sharp, high-quality images

## Tow Color Correction Matrix

EBU or NTSC preset color correction matrix can be selected.

• Photos are an approximate image.

# Easy-to-use, high-performance camera head

## Designed for easy operation and expandability

The AK-HC3500 incorporates Panasonic's extensive broadcast camera design know-how to provide even easier operation. Convenient features include a backlight on the rear operation panel for improved operation in dark settings and an SD Memory Card slot for easy storage of user settings. A movable optical connector is also provided to reduce stress on the optical cable.

### Variable internal diameter lens mount for easy use with a build-up unit

When mounting onto an optional build-up unit, a mechanism enlarges the internal diameter of the lens mount. Because the lens and camera can be separately mounted onto or removed from the build-up unit, previously troublesome lens removal is eliminated for faster, more convenient operation.

### Movable optical cable connector

Connection to a camera control unit (CCU) is with SMPTE standard optical fiber cable. Transmission of high quality images and different types of signals is possible even when the camera and CCU are separated by a distance of up to about 2.0 km. Operation convenience is further assured by the movable connector.



### Servocontrol ND/CC Filters

The following ND/CC motor driven double optical filters are available for shooting in any lighting conditions.

- [CC filters]  
3 200 K, 4 300 K,  
6 300 K, Cross, Diffusion
- [ND filters]  
Cap, 100 %, 25 %, 6.3 %, 1.6 %



Back Light for Rear Operation

### Menu Switch



### SD Memory Card slot

Using an SD Memory Card enables storage and retrieval of various camera settings such as user viewfinder indications. Camera settings stored on an SD Memory Card can also be retrieved.

\* SD Memory Cards are sold separately. (Panasonic cards with a capacity of 2GB or lower are recommended. SDHC Memory Cards are not compatible.)

JOG Dial Button

Two RS422/RS232C Data Trunk Lines

Camera/RET/VF HD-SDI Output

### AUX connector

Either standard RET-Y input or PROMPT2 output can be selected. And with the optional AK-HDC3500 down converter board installed, selection of one of four types of output, including SD-SDI and VBS output, is possible. The connector can also be used for crane shots and other monitoring applications.

## Ergonomic design for easy handling

In response to customer requests, we have made numerous improvements over prior models. These include optimal weight balance, boosted efficiency when used with a build-up unit, and a low center of gravity for more comfortable handling. Thanks to this advanced design, the AK-HC3500 helps to reduce user fatigue while assuring exceptional efficiency both in the studio and at outdoor venues.



In addition to the low center of gravity of the camera itself, the AK-HC3500 features slip-resistant shoulder pads adjustable up to 24 mm front and back. These design innovations help reduce fatigue during shoulder-mount use while assuring stable shooting.



The handle's end is shaped to enable easy carrying.

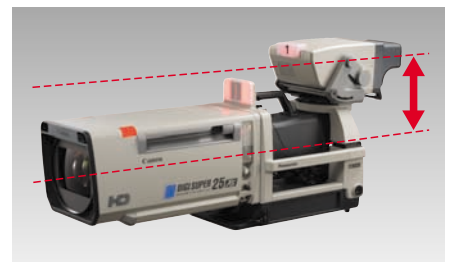

Lowering the height of the camera has moved the viewfinder closer to the camera's optical axis, thereby reducing the azimuth difference for improved operating convenience.

## Fast, easy mounting onto a build-up unit

Mounting a CRT viewfinder is also easy.



**1** Open the build-up unit's build-up adapter.

**2** Mount the AK-HC3500.

**3** Return the build-up adapter to complete mounting.

## Build-up Unit AK-HBU3500



- Large studio lenses can be mounted.
- Smooth, fast camera mounting is possible.
- Innovative design minimizes camera and viewfinder azimuth difference and lowers the center of gravity.

Adjustment functions	AC output reset, VF ON/OFF, Up tally ON/OFF, Marker ON/OFF, Cursor setting, Cursor memory 1, Cursor memory 2, 4:3 Marker, ND filter selection, Local, CC filter selection, Menu ON/OFF, Menu jog, RET A switch, RET B switch, User, VF DTL, Monitor output selection, H-POSI, V-POSI, WIDTH, HEIGHT
Power supply	AC220 V (when connecting camera)
Power consumption	Approx. 20 W
Dimensions (WxHxD)	300 mm x 417 mm x 570 mm
Weight	Approx. 14.5 kg

The LCD viewfinder makes mounting even simpler.

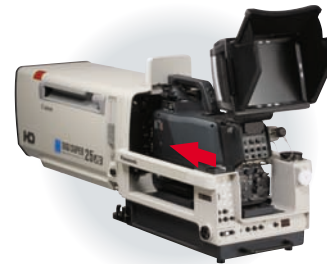

Even with an LCD viewfinder mounted on the camera, the camera can be mounted onto the build-up unit just by sliding it in.

## Build-up Adapter



### AK-HBA3500

The 7" CRT Viewfinder AK-HVF985B can be easily mounted.

Dimensions (WxHxD)	279 mm x 143 mm x 180 mm
Weight	Approx. 2.5 kg

## Viewfinder



2" B/W Viewfinder  
**AJ-HVF21G**



7" CRT Viewfinder  
**AK-HVF985B**



8" LCD Color Viewfinder  
**AK-HVF931A**

- Controllers are easily accessible with one hand.
- Pan angle:  $\pm 90^\circ$
- 1080i, 720p switchable
- Aspect ratio 16:9/4:3 switchable

	AJ-HVF21G	AK-HVF985B	AK-HVF931A
Adjustment functions		Brightness, Contrast, Peaking	
Power supply	DC12 V (supplied from camera)	DC24 V (supplied from build-up unit)	DC12 V (supplied from camera)
Power consumption	Approx. 3.8 W	Approx. 38 W	Approx. 18 W
Dimensions (WxHxD)	240 mm x 80 mm x 206 mm	257 mm x 185 mm x 403 mm	275 mm x 209 mm x 230 mm
Weight	Approx. 0.75 kg	Approx. 7.7 kg	Approx. 2.8 kg

## Down Converter Board AK-HDC3500 (option)

The AK-HC3500 can output an SD-SDI or a VBS output from the camera head.

# Versatile system components

To meet system requirements, a wide range of convenient peripheral equipment is available, including a camera control unit (CCU), remote operation panel (ROP) and a master setup unit (MSU).

## Camera Control Unit AK-HCU935

The half-rack size Camera Control Unit AK-HCU935 uses the optical fiber transmission system for maintaining superb picture quality between the camera and CCU even from long distances.

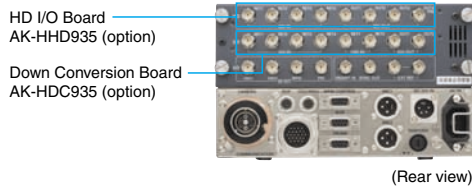

- Up to four SD-SDI inputs, two VBS inputs, two SD-SDI outputs, two VBS outputs, a PM output, and a WFM output may be added in combination with an optional board<sup>1\*</sup>.
- Up to four HD-SDI inputs/outputs may be added in combination with an optional board<sup>2\*</sup>.
- PROMPT input
- Two-channel data trunk lines (RS-422)
- RTS/4 wires/2 wires intercom system input/output

Video input/output	PROMPT input, SD-SDI/VBS/PM/WFM <sup>1*</sup> , HD-SDI <sup>2*</sup>
Sync input/output	Input: HD reference (tri-level sync), SD reference (B.B.) (It can be selected by a switch.) Output: HD SYNC, SD SYNC <sup>1*</sup> (It can be selected by a switch.)
Audio input/output	Analog audio outputs (MIC1, 2)
Power supply	AC220 V
Power consumption	Approx. 50 W
Operating temperature	0 °C to 40 °C
Storage temperature	-20 °C to 60 °C
Dimensions (WxHxD)	214 mm x 131 mm x 456 mm
Weight	Approx. 12.0 kg (CCU)/0.5 kg (blank panel)

<sup>1\*</sup> The optional Down Converter Board AK-HDC935 is required.  
<sup>2\*</sup> The optional HD I/O Board AK-HHD935 is required.

### Feature Boards

#### Down Converter Board AK-HDC935

The board includes both SD I/O and F.CONV.



- SD I/O**
- Input: SD-SDI (BNC x 4), VBS (BNC x 2)
  - Output: SD-SDI (BNC x 2)

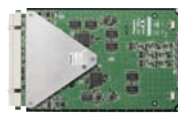

- F.CONV.**
- Up/down-convert processor board

#### HD I/O Board AK-HHD935

- Input: HD-SDI (BNC x 4)
- Output: HD-SDI (BNC x 4)



## Master Setup Unit AK-MSU935

The MSU (with a large LCD control panel) can adjust the camera's entire parameters; serves up to 12 camera systems.



- Master control of precise camera settings for the entire camera system (up to 12 camera systems)
- Large scale (6.3 inch) LCD display
- SD memory card slot for storing/recalling three user references, eight scene files, and sixteen lens files

Adjustment functions	Camera selection, MODE ON/OFF (5600 K, flare OFF, black gamma ON, gamma OFF, knee OFF, white clip OFF, HD matrix ON, PM character display, HDTV detail OFF, SDTV detail OFF, HDTV skin tone detail ON, SDTV skin tone detail ON), Control item selection (UNDO, black shading selection, white shading selection, R/G/B shading, matrix control, FUNC, system, pedestal control, gain control, gamma control, flare control, white clip control, HD detail control, SDTV detail), ALL, Reference, Camera video output selection, Automatic adjustment (white balance, black balance, setup), Monitor selection (P-M, WFM), Scene files, SHUTTER, Gain selection, Filter selection (HEAD, ND filter, CC filter), CALL, Auto iris, Lens file storage, Lens file call, Iris active, Master pedestal storage, Master pedestal file call, Iris, Master pedestal
Power supply	DC12 V
Power consumption	Approx. 15 W
Operating temperature	0 °C to 40 °C
Storage temperature	-20 °C to 60 °C
Dimensions (WxHxD)	340 mm x 75 mm x 264 mm
Weight	Approx. 3.25 kg

## Remote Operation Panel AK-HRP931

The 1/3 rack size remote operation panel can easily adjust camera parameters.



(Rear view)

- Full control of camera settings
- Joystick-type iris control
- 1/3 rack size remote operation panel

CCU control	Control signals (camera, CCU control) Power supply (DC12 V) Tally control signals
RCP control	Control signals (fader control) Power supply (DC12 V)
Power supply	DC12 V (supplied from CCU)
Power consumption	Approx. 6 W
Operating temperature	0 °C to 40 °C
Storage temperature	-20 °C to 60 °C
Dimensions (WxHxD)	136 mm x 55 mm x 419 mm
Weight	Approx. 2.3 kg

## Remote Operation Panel AK-HRP935

The 1/4 rack size remote operation panel can easily adjust camera parameters.



(Rear view)

- Full control of camera settings
- Joystick-type iris control
- 1/4 rack size remote operation panel

CCU control	Control signals (camera, CCU control) Power supply (DC12 V)
RCP control	Control signals (fader control) Power supply (DC12 V)
Power supply	DC12 V (supplied from CCU)
Power consumption	Approx. 6 W
Operating temperature	0 °C to 40 °C
Storage temperature	-20 °C to 60 °C
Dimensions (WxHxD)	92 mm x 60 mm x 385 mm
Weight	Approx. 1.8 kg

### Product Configuration

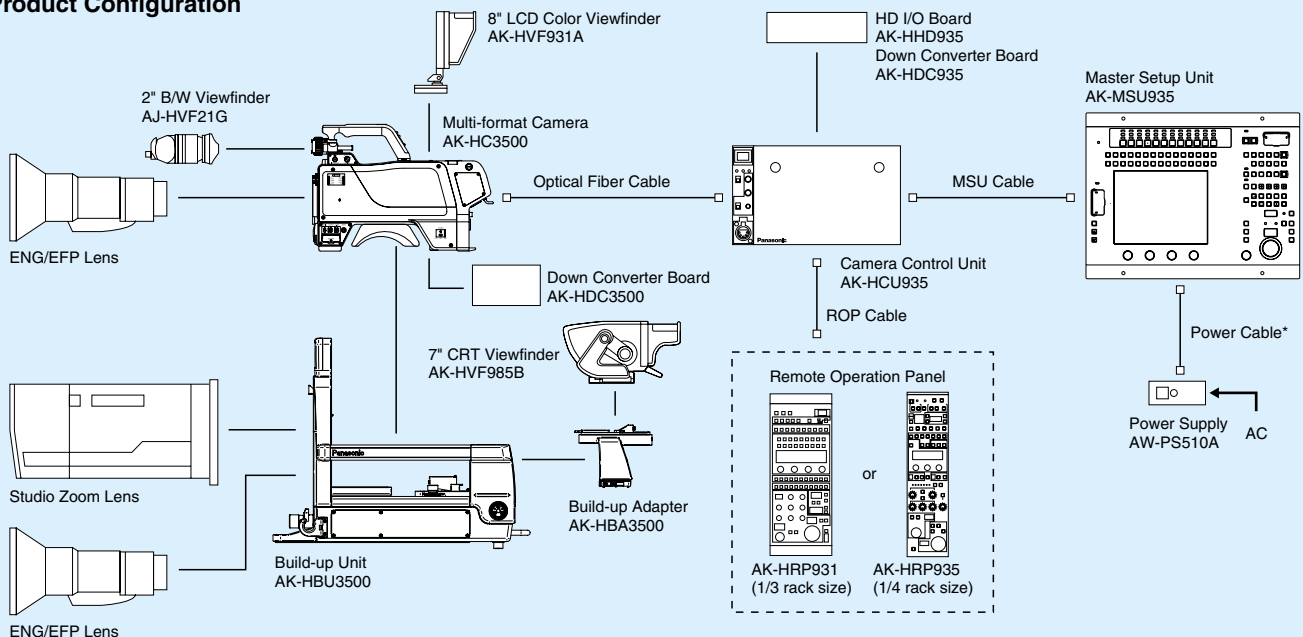

\* A power cable is included with the AW-PS510A.

## Specifications

CCD	2/3" 2.2-megapixels IT-3CCD	
Image sensing method	GBR Image sensing method	
Total number of pixels	2 010 (H) x 1 120 (V)	
Effective number of pixels	1 920 (H) x 1 080 (V)	
Optical prism	F1.4 Prism	
Optical filter	CC	3 200 K, 4 300 K, 6 300 K, Cross, Diffusion
	ND	Cap, 100 %, 25 %, 6.3 %, 1.6 %
Lens mount	2/3" Bayonet mount	
Sensitivity	F10 (1080/59.94i)/F11 (1080/50i) at 2 000 lx, 3 200 K, 89.9 % white	
S/N	60 dB (typ)(1080/59.94i) 60 dB (typ)(1080/50i)	
M.T.F	50 % (typ)(27.5 MHz)	
Storage temperature	-20 °C to 60 °C	
Operating temperature	-10 °C to 45 °C * The camera must be turned on at least 30 minutes prior to use in ambient temperatures of -10 °C to 0 °C.	
Power consumption	Approx. 25 W (DC12 V/camera head only)	
Dimensions (WxHxD)	135 mm x 260 mm x 360 mm	
Weight	Approx. 4.7 kg	
HD SDI output	HD signal:0.8 Vp-p 75 Ω (BNC)	
Monitor output <sup>1*</sup>	HD signal:0.8 Vp-p 75 Ω (BNC)	
PROMPT output	VBS signal:1 Vp-p 75 Ω (BNCx2)	
GENLOCK input	Tri-level SYNC/Black Burst (BNCx1)	
AUX output	Selectable one of RET-Y input, PROMPT2 output, SD-SDI output <sup>2*</sup> and VBS output <sup>2*</sup>	
Microphone input <sup>3*</sup>	-20 dBm/-30 dBm/-40 dBm/-50 dBm/-60 dBm (XLR 3pin x2)	
INCOM <sup>4*</sup>	0 dBm/600 Ω (XLR 4pin x2)	

<sup>1\*</sup> HD signal can be selected by the monitor output selection switch.

<sup>2\*</sup> To when down converter board is installed.

<sup>3\*</sup> Gain is selected by the gain switch.

<sup>4\*</sup> Mixing is controlled separately for PGM1 and PGM2.

\* Specifications and functions are subject to change without notice due to continual improvements.

## Dimensions

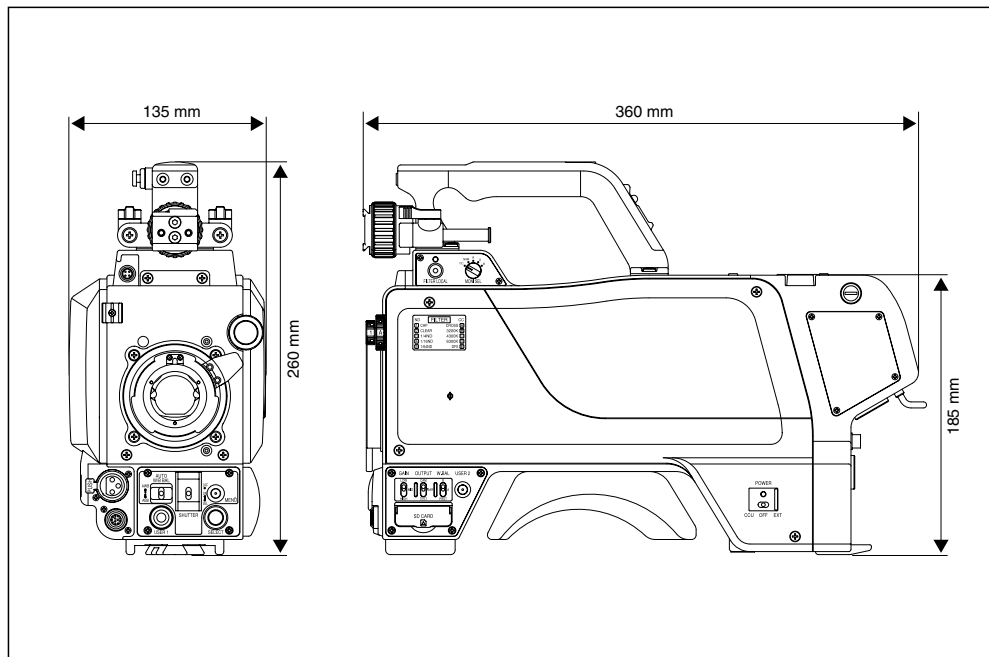

• SD Logo is a trademark.

# Panasonic

Matsushita Electric Industrial Co., Ltd.  
Panasonic System Solutions Company  
Corporate Broadcast and Multimedia Business Unit

4-3-1 Tsunashima-Higashi,  
Kohoku-ku, Yokohama City 223-8639, Japan

<http://panasonic.biz/broad/>

Australia +61 2 9986 7400  
Bahrain +973 252292  
Egypt +20 2 3938151  
Indonesia +62 21 385 9449  
Iran +98 21 2271463  
Jordan +961 6 586 1914  
Kazakhstan +7 3272 980 891

Kuwait +965 481 2123  
Lebanon +961 1 216827  
Malaysia +60 3 5549 5422  
New Zealand +64 9 272 0100  
Pakistan +92 5370320 21  
Russia & CIS +7 495 980 42 06  
Saudi Arabia +966 1 465 0709  
Singapore +65 6270 0110  
South Africa +27 11 313 1400

Thailand +66 2 731 8888  
U.A.E. +971 4 282201  
Ukraine +380 44 4903437  
[ext. 112]

AK-JEHC350008

Printed in Japan