



IMPRESSA F70/F707

Instructions for use



**I
M
P
R
E
S
S
A**

Legend:

- **DISPLAY** DISPLAY: serves as information.
- **DISPLAY** DISPLAY: please follow the instructions shown.

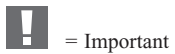



Fig. 1



Fig. 2



Fig. 3



Fig. 4



Fig. 5



Fig. 6



Fig. 7



Fig. 8



Fig. 9



Fig. 10



Fig. 11



Fig. 12



Fig. 13



Fig. 14



Fig. 15

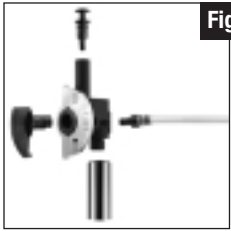

Fig. 16

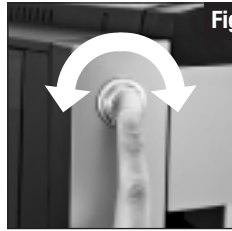

Fig. 17



Fig. 18

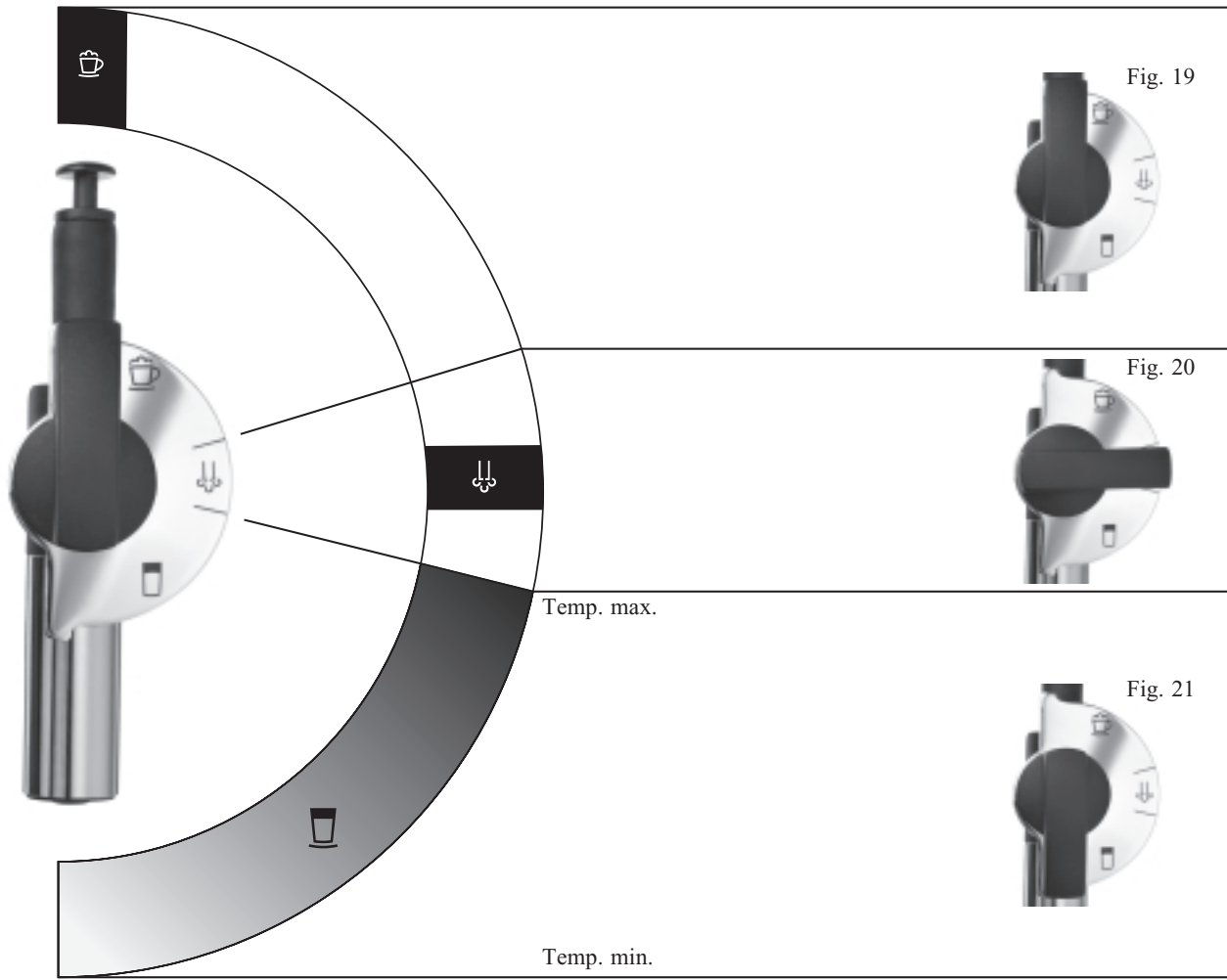
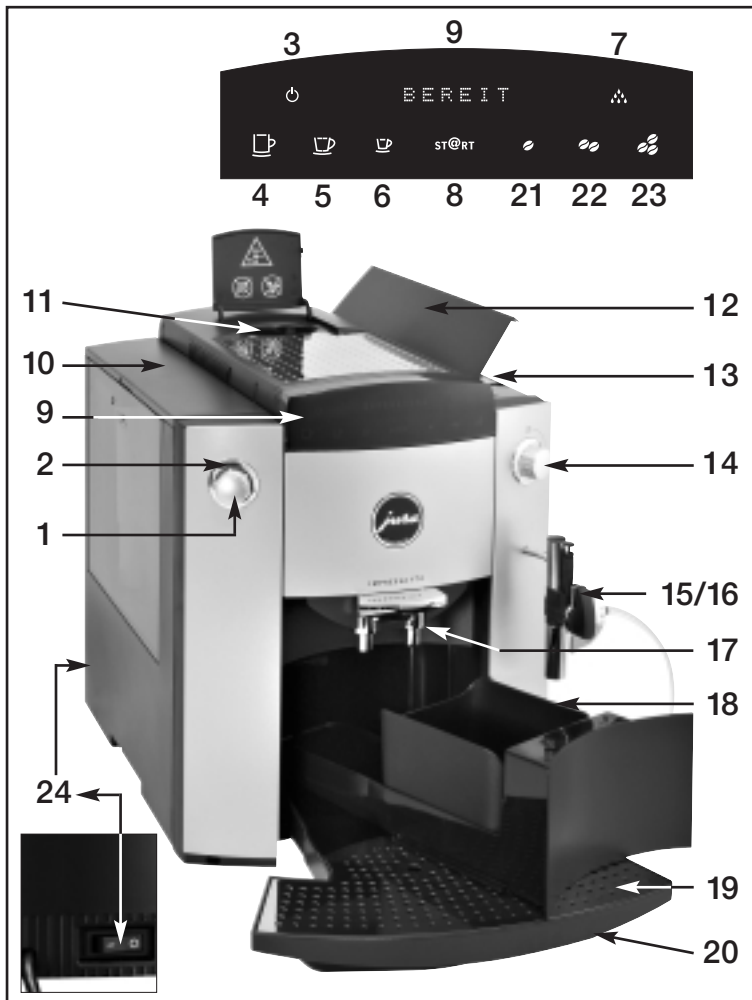

Fig. 19

Fig. 20

Fig. 21



Control elements

1. Rotary Switch
2. Illuminated ring
3. ON / OFF symbol
4. 1 LARGE CUP symbol
5. 1 COFFEE symbol
6. 1 ESPRESSO symbol
7. MAINTENANCE symbol
8. START symbol
9. Display dialog system
10. Water tank with handle
11. Filler funnel for pre-ground coffee
12. Bean tank cover
13. Aroma preservation cover
14. Steam / hot water draw-off tap
15. Profi-Auto-Cappuccino Frother with milk pipe
16. Interchangeable hot water nozzle (see Fig. 5)
17. Height-adjustable coffee spout
18. Coffee grounds container
19. Drip grate
20. Drip tray
21. MILD symbol
22. NORMAL symbol
23. STRONG symbol
24. Power switch

Contents

1. Safety information.....	page 7	15. Programming	page 17
1.1 Warning.....	page 7	15.1 Programming the filter	page 17
1.2 Precautions.....	page 7	15.2 Programming the water hardness.....	page 17
2. Preparing the IMPRESSA.....	page 7	15.3 Maintenance menu.....	page 17
2.1 Check supply voltage.....	page 7	15.4 Programming the aroma INTENSIVE or STANDARD	page 17
2.2 Check electrical fuse.....	page 7	15.5 Programming the temperature.....	page 18
2.3 Fill water tank.....	page 7	15.6 Programming the time.....	page 18
2.4 Fill coffee beans.....	page 8	15.7 Programming the automatic switch-on time.....	page 19
2.5 Adjusting the grinding gear	page 8	15.8 Programming the automatic switch-off time.....	page 19
2.6 Power switch.....	page 8	15.9 Cup counter	page 19
3. First use.....	page 8	15.10 Programming the language.....	page 19
4. Adjusting the water hardness	page 9	15.11 Programming Display 24H/AM/PM	page 20
5. Installation of CLARIS plus filter cartridges	page 10	15.12 Programming the display for ML/OZ.....	page 21
5.1 Installing the filter	page 10	15.13 Exit programming mode	page 21
5.2 Replacing the filter.....	page 10	16. Maintenance	page 21
5.3 Changing the filter without display request..	page 11	16.1 Filling in water.....	page 21
6. Rinsing the IMPRESSA.....	page 11	16.2 Emptying the coffee grounds container	page 21
6.1 Rinsing the IMPRESSA without display request	page 11	16.3 Drip tray missing.....	page 22
7. Adjusting the water quantity for coffee.....	page 11	16.4 Fill coffee beans.....	page 22
8. Making 1 cup of coffee.....	page 12	16.5 Replacing the filter.....	page 22
9. Making 2 cups of coffee.....	page 12	16.6 Cleaning the IMPRESSA	page 22
10. Drawing off pre-ground coffee	page 13	16.7 IMPRESSA calcified	page 22
11. Drawing off hot water	page 13	16.8 General cleaning instructions	page 22
12. Dispensing steam.....	page 14	16.9 Emptying the system	page 23
13. Dispensing Cappuccino with the Professional Cappuccino Frother.....	page 14	17. Cleaning.....	page 23
13.1 Dispensing Hot Milk with the Professional Cappuccino Frother	page 15	17.1 Cleaning without display request.....	page 24
13.2 Cleaning of the Professional Cappuccino Frother	page 15	18. De-scaling.....	page 24
13.3 Rinsing the Professional Cappuccino Frother	page 16	18.1 Decalcifying without display request	page 25
13.4 Cleaning the Professional Cappuccino Frother	page 16	19. Disposal	page 25
14. Switching off the IMPRESSA	page 16	20. Tips for perfect coffee	page 26
		21. Messages.....	page 27
		22. Problems.....	page 28
		23. Legal information.....	page 29
		24. Technical data.....	page 29

Introduction

Thank you for purchasing the IMPRESSA. To ensure perfect functioning of your IMPRESSA, carefully read this operating manual and keep it for future reference.

Should you need more information or if you encounter particular problems not specified in these operating instructions in sufficient detail, either contact us directly or contact your local authorized dealer.



You will also find useful tips on operation and maintenance of your IMPRESSA on our website at www.jura.com.

1. Safety information

1.1 Warning

- Children do not realize the dangers involved in using electric appliances, for this reason always keep an eye on children when they use electric appliances.
- The coffee machine may only be used by instructed persons.
- Never use a defective coffee machine or a machine with a defective mains cable.
- Never repair or open the coffee machine yourself. Any repairs may only be carried out by authorized service shops using original spare parts and accessories.
- Never immerse the coffee machine in water.

1.2 Precautions

- Never expose the coffee machine to weather (rain, snow, frost), never touch the machine when your hands are wet.
- Place the IMPRESSA on a firm, level base that is resistant to any water that may leak. Never stand on hot or warm surfaces (oven hobs). Keep out of the reach of children.

- If you don't use the machine for a longer time (holidays, etc.) always disconnect the mains cable.
- Always disconnect mains cable before cleaning the machine.
- When disconnecting the mains cable never pull on the mains cable or the machine itself.
- The coffee machine is connected to mains supply via a mains cable. Make sure nobody can trip over the mains cable. Make sure children and pets cannot reach the machine
- Never put the coffee machine or individual parts of it into a dishwasher.
- Make sure to install the machine at a place with sufficient air circulation, to prevent overheating of the machine.

2. Preparing the IMPRESSA

2.1 Check supply voltage

The IMPRESSA is preset in the factory to the correct mains voltage. Check if your local mains supply voltage complies with the information given on the type plate on the underside of the IMPRESSA.

2.2 Check electrical fuse

The IMPRESSA is designed for an electric current of 10 amperes. Check if the electrical fuse has sufficient capacity.

2.3 Fill water tank



- Only use fresh, cold water. Never fill in milk, mineral water or other liquids.
- Remove the water tank and rinse it with cold tap water thoroughly (Fig. 4).

- Then fill the water tank and reinstall it. Make sure to install the tank properly, it must engage audibly.

2.4 Fill coffee beans

! To ensure that your machine will work perfectly for a long time and to avoid damage, please note that the grinding gear of your JURA coffee machine is not suitable for coffee beans which were treated, during or after roasting, with additives (e.g. sugar). Such coffee blends may damage the grinding gear. Any repair costs resulting from the use of such blends are not covered by warranty.

- Open the bean tank cover (12) and remove the aroma preservation cover (13).
- Remove any dirt or foreign matter from the bean tank.
- Fill coffee beans in the bean tank and close the cover.

2.5 Adjusting the grinding gear

You can adjust the grinding gear to the roast of your coffee. We recommend

- a fine grinding degree → for bright roasts (the smaller the dots, the finer the grinding)
- a coarse degree → for dark roasts (the larger the dots, the coarser the grinding)

! The grinding degree may only be adjusted while the grinding gear is running.



- Open the bean tank cover (12) and remove the aroma preservation cover (13).
- To adjust the grinding degree, turn the rotary switch (Fig. 2) to the required position.

2.6 Power switch

! Actuate the power switch (24) on your IMPRESSA before using the machine for the first time.

➔ We recommend that you switch off your IMPRESSA with the power switch (24) if you intend not to use the machine for longer periods of time (e.g. during holidays).

3. First use

- Fill coffee beans in the bean tank (12).
- Switch on the IMPRESSA using the power switch (24).
- **DISPLAY**  Your IMPRESSA is in standby mode.
- Touch the  (3) symbol
- **DISPLAY** SPRACHE
DEUTSCH
- The illuminated ring (2) is active.
- Turn the rotary switch (1) until the required language is displayed (Fig. 17).
- For example **DISPLAY** LANGUAGE
ENGLISH
- Confirm your selection by pressing the rotary switch (1) (Fig. 17).
- **DISPLAY** FILL
WATER
- Fill the water tank (10) with fresh water.
- **DISPLAY** OPEN TAP
- Place a receptacle under the Professional Cappuccino Frother (15) (Fig. 10).
- Open the steam / hot water draw-off tap (14) (Fig. 12).
- **DISPLAY** FILLING
SYSTEM

- **DISPLAY** CLOSE TAP
- Close the steam / hot water draw-off tap (14).
- **DISPLAY** FILLING SYSTEM
- **DISPLAY** HEATING
- **DISPLAY** PRESS MAINT.
- Touch the symbol ☼ (7).
- Machine carries out a rinsing operation.
- **DISPLAY** RINSING
- **DISPLAY** READY

 If BEANS FILL is displayed, press the coffee draw-off key again. Machine not filled with coffee beans yet.

 To get an excellent crema, adjust the coffee spout (17) to the size of your cup (Fig. 3).

4. Adjusting the water hardness

 Water is heated in the IMPRESSA. As a result, calcification occurs during normal use and is indicated automatically. Before using the IMPRESSA for the first time the hardness of the water used must be adjusted. Use the supplied test sticks for this.

 1° German hardness is equivalent to 1.79° French hardness.

 If the filter is activated, the program step Water Hardness no longer appears.

 The IMPRESSA has 5 hardness degrees which can be used and are displayed while you are adjusting the water hardness.

The displayed information means the following:

- LEVEL — Water hardness function switched off
- LEVEL 1 German water hardness degree 1 to 7°
French Water hardness degree 1.79 – 12.53°
- LEVEL 2 German water hardness degree 8 to 15°
French Water hardness degree 14.32 – 26.85°
- LEVEL 3 German water hardness degree 16 to 23°
French Water hardness degree 28.64 – 41.14°
- LEVEL 4 German water hardness degree 24 to 30°
French Water hardness degree 42.96 – 53.7°

When the IMPRESSA leaves the factory it is adjusted to LEVEL 3. You can adjust another hardness. To do this, proceed as follows:

- **DISPLAY** READY
- Press the Rotary Switch (1) until **DISPLAY** FILTER –/√ appears
- **DISPLAY** FILTER –
- Turn the Rotary Switch (1) until the following message is displayed:
- **DISPLAY** HARDNESS
- Now press the Rotary Switch (1) to start the programming.
- **DISPLAY** LEVEL 3
- Turn the Rotary Switch (1) until the required level is displayed.
- For example, **DISPLAY** LEVEL 4
- Press the Rotary Switch (1) to confirm the required level.
- **DISPLAY** HARDNESS
- Turn the Rotary Switch (1) until **DISPLAY** EXIT appears
- Press the Rotary Switch (1) to leave the programming mode.
- **DISPLAY** READY

5. Installation of CLARIS plus filter cartridges

 If the CLARIS plus filter cartridge is installed properly, de-scaling of the coffee machine is no longer required. For more information on the CLARIS plus filter cartridge refer to brochure «CLARIS plus. Hard on limescale. Gentle on your coffee machine.»

5.1 Installing the filter

 Draw off 1/2 litre of water to rinse filter completely. In order to ensure perfect operation, close tap (14) only after the display says

DISPLAY CLOSE TAP

- Fold up the cartridge holder. Install the filter cartridge in the water tank, applying a gentle pressure (Fig. 1).
- Fold down the cartridge holder again until it engages audibly.
- Fill the water tank with cold, fresh tap water and install it again.
- Press the Rotary Switch (1) until **DISPLAY** FILTER –/✓ appears
- **DISPLAY** FILTER –
- Press the Rotary Switch (1) to start the programming.
- **DISPLAY** NO –
- Turn the Rotary Switch (1) until the following message is displayed:
■ **DISPLAY** YES ✓
- Press the Rotary Switch (1) to activate the filter cartridge.
- **DISPLAY** INSERT
OPEN TAP
- Put a sufficiently large container (at least 0.5 litre) under the Professional Cappuccino Frother (15) (Fig. 10).
- Turn the selector switch of the Professional Cappuccino Frother (15) to the steam position (Fig. 20).

- If not installed already, insert the CLARIS plus filter.
- Open the steam / hot water draw-off tap (14) (Fig.12).

■ **DISPLAY** RINSING
FILTER

■ **DISPLAY** CLOSE TAP

- Close the steam/hot water draw-off tap (14), now the IM-PRESSA will heat up to coffee temperature.

■ **DISPLAY** HEATING UP

■ **DISPLAY** READY

 Now you have activated the filter. In Programming Mode the water hardness selection function is no longer displayed.

5.2 Replacing the filter

 Draw off 1/2 litre of water to rinse filter completely. In order to ensure perfect operation, close tap (14) only after the display says

DISPLAY CLOSE TAP

 After drawing off approx. 50 litres, the filter cartridge will be used up. A message requesting you to replace the filter will appear on the display. The scale on the cartridge holder in the water tank will tell you how much longer you can use the CLARIS plus filters.

■ **DISPLAY** CHANGE FILTER / MACHINE READY

- Touch the ☼ symbol (7).

■ **DISPLAY** REPLACE
OPEN TAP

- Remove the water tank from the machine and empty it.
- Fold up the cartridge holder. Install the filter cartridge in the water tank, applying a gentle pressure (Fig. 1).
- Fold down the cartridge holder again until it engages audibly.

- Fill the water tank with cold, fresh tap water and reinstall it.
- Place a sufficiently large receptacle (at least 1/2 litre) under the Professional Cappuccino Frother (15) (Fig. 10).
- Turn the selector switch of the Professional Cappuccino Frother (15) to the steam position (Fig. 20).
- Open the tap for dispensing steam/hot water (14) (Fig. 12).
- **DISPLAY** RINSING
FILTER
- **DISPLAY** CLOSE TAP
- Open the steam / hot water draw-off tap (14) (Fig. 12).
- **DISPLAY** HEATING UP
- **DISPLAY** READY

5.3 Changing the filter without display request

- Press the Rotary Switch (1) until **DISPLAY** FILTER ✓ appears.
- Press the Rotary Switch (1) to confirm.
- **DISPLAY** YES ✓
- Press the Rotary Switch (1) again to confirm.
- **DISPLAY** INSERT/OPEN TAP
- The program “Change filter” is now active. Now proceed as described in Chapter 5.2 from **DISPLAY** REPLACE/OPEN TAP onwards.

6. Rinsing the IMPRESSA

- ➔ When the IMPRESSA is switched off and has cooled down, a rinsing operation is started when the machine is switched on again. When the machine is switched off, a rinsing operation is started automatically.

- Touch the ☺ symbol (3).
- **DISPLAY** HEATING UP
- **DISPLAY** PRESS
MAINT.
- Touch the ☼ symbol (7).
- **DISPLAY** RINSING
- **DISPLAY** READY

6.1 Rinsing the IMPRESSA without display request

- Press the Rotary Switch (1) until **DISPLAY** FILTER -/✓ appears.
- Turn the Rotary Switch (1) until **DISPLAY** MAINTENANCE appears.
- Press the Rotary Switch (1) to confirm.
- **DISPLAY** RINSE
- Press the Rotary Switch (1) again to confirm.
- **DISPLAY** RINSING
- **DISPLAY** READY

7. Adjusting the water quantity for coffee







- ➔ The indicated value in ML is a reference value and may deviate from the actual value
- 💡 You can change/stop the water quantity during the draw-off operation, too. Turn the rotary switch (1) until the required ML value is displayed.

You can adjust the water quantity in steps of 5 ML using the Rotary Switch (1).

- **DISPLAY** READY

- Turn the Rotary Switch (1) until the required water quantity is displayed.
- For example, **DISPLAY** 120 ML

8. Making 1 cup of coffee



 You can choose from 3 different coffee strengths. Touch one of the symbols  /  /  to select the strength of your coffee.  MILD  NORMAL  STRONG.

 You can set the amount of water you want with the Rotary Switch (1) prior to drawing off coffee

 Touch the **ST@RT** (8) symbol to stop drawing off coffee prematurely.

 The amount of coffee water you used last is saved by the IMPRESSA until the next time you make coffee.

 Press the Rotary Switch (1) briefly to check how much coffee water you used last.

- **DISPLAY** READY
- Place a cup under the height-adjustable coffee spout (17).
- Touch the  (5).
- **DISPLAY** COFFEE symbol
- Select an aroma by touching one of the symbols
- E.g.  (STRONG aroma)
- **DISPLAY** STRONG
- Touch the **ST@RT** (8) symbol
- **DISPLAY** 160 ML (water quantity last adjusted).
- The illuminated ring (2) is active.
- Turn the Rotary Switch (1) until the required amount of coffee water appears on the display (9).

- **DISPLAY** e.g. 120 ML
- **DISPLAY** COFFEE
- Your coffee is being prepared.
- **DISPLAY** READY

9. Making 2 cups of coffee

 You cannot choose the strength of the coffee when making 2 cups. The machine automatically makes 2 mild cups of coffee.

 You can set the amount of water you want with the Rotary Switch (1) prior to drawing off coffee

 Touch the **ST@RT** (8) symbol to stop drawing off coffee prematurely.

 The amount of coffee water you used last is saved by the IMPRESSA until the next time you make coffee.

 Press the Rotary Switch (1) briefly to check how much coffee water you used last.

- **DISPLAY** READY
- Place two cups under the height-adjustable coffee spout (17).
- Touch the coffee draw-off symbol of your choice twice
- **DISPLAY** 2 COFFEE
- **DISPLAY** 120 ML (water quantity last adjusted).
- The illuminated ring (2) is active.
- Turn the Rotary Switch (1) until the required amount of coffee water appears on the display (9).
- **DISPLAY** e.g. 210 ML
- **DISPLAY** 2 COFFEE

- Your coffee is being prepared.

■ **DISPLAY** READY

10. Drawing off pre-ground coffee

➔ Never use instant coffee or quick-coffee. We recommend that you always use powder from fresh coffee beans or, pre-ground, vacuum-packed coffee. Never fill in more than 2 portions of powder. The pre-ground coffee tank is no storage tank. Make sure that the pre-ground you use is not too fine. This may cause blocking of the system. In this case the coffee only drips out of the coffee spout.

➔ If you have filled in too little powder, the message NOT ENOUGH POWDER will be displayed. The IMPRESSA stops the operation and returns to "ready for draw off" mode.

➔ You can stop the draw-off operation at any time by pressing any coffee draw-off key.

■ **DISPLAY** READY

- Put 1 or 2 cups under the adjustable coffee spout (17).

- Open the cover of the filler funnel for pre-ground coffee (11).

■ **DISPLAY** FILL
POWDER

- Fill 1 or 2 level spoonfuls of pre-ground coffee in the filler funnel for pre-ground coffee (11) (Fig. 15) and close the cover.

■ **DISPLAY** SELECT
KEY

- Press the required draw-off key.

- Touch the **ST@RT** (8) symbol

■ **DISPLAY** 120 ML (water quantity last adjusted)

- The illuminated ring (2) is active.

- Turn the Rotary Switch (1) again to select the water quantity individually:

■ For Example: **DISPLAY** 210 ML

■ **DISPLAY** COFFEE

- Your product is being prepared.

■ **DISPLAY** READY

11. Drawing off hot water

➔ The amount of hot water you used last is saved by the IMPRESSA until the next time you make coffee.

! Install the hot water nozzle (see Fig. 5) to obtain perfect water flow. Do not replace the replaceable hot water nozzle (16) directly after drawing off water, because the nozzle is hot after the draw-off operation.

➔ At the start of the water draw-off operation there can be splashing. Avoid direct contact with the skin!

■ **DISPLAY** READY

- Place a cup under the replaceable hot water nozzle (16).

- Open the steam / hot water draw-off tap (14) (Fig. 12).

- The illuminated ring (2) is active.

■ **DISPLAY** STEAM

- Touch the **ST@RT** (8) symbol

■ For example, **DISPLAY** 140 ML

■ **DISPLAY** WATER

- Adjust the required water quantity by turning the rotary switch (1).

■ For example, **DISPLAY** 200 ML

■ **DISPLAY** WATER

- If the required water quantity is reached, the following message is displayed:
- **DISPLAY** CLOSE TAP
- Close the steam / hot water draw-off tap (14).
- **DISPLAY** READY



Before CLOSE TAP water may still escape the system.

12. Dispensing steam



The steam function is used for the preparation of milk foam and hot milk, as well as for the Professional Cappuccino Frother (15) cleaning programme.



With the optionally available 2-stage frothing nozzle, liquids can be heated and frothed using the steam function.



Make sure that the nozzle is correctly fitted when drawing steam. If the nozzle becomes blocked with particles of milk residue or is incorrectly assembled, a danger can arise during use whereby the nozzle may jump off.



Due to the system design, some water will escape at first when steam is drawn. However, this will not affect the result in any way.



When drawing steam, spluttering can occur at the start. The nozzle becomes hot in use. Avoid any direct skin contact.

- **DISPLAY** READY
- To draw off steam, open the steam/hot water draw-off tap (14) (Fig. 12).
- The illuminated ring (2) is active.
- **DISPLAY** STEAM

- You can adjust the steam draw-off time individually by turning the rotary switch (1) until the required SEC are displayed.
- For example, **DISPLAY** 35 SEC
- If you do not change the steam draw-off time settings using the rotary switch (1), the machine will use the settings last adjusted.
- During the steam draw-off operation, the message STEAM is displayed.
- When the steam quantity is reached, the message CLOSE TAP is displayed.
- Close the steam / hot water draw-off tap (14).
- **DISPLAY** READY



At any time, you can abort steam dispensing early, by closing the tap for dispensing steam/hot water (14).



Before CLOSE TAP, steam may still escape the system.

13. Dispensing Cappuccino with the Professional Cappuccino Frother



Cappuccino comprises one third each of Espresso, hot milk and milk foam. You produce the milk portion with the Professional Cappuccino Frother (15). When steam is drawn, a vacuum is produced which, with the aid of the Professional Cappuccino Frother (15), draws in the milk and produces milk foam.



To ensure perfect function, the Professional Cappuccino Frother (15) must be cleaned regularly.



Make sure that the nozzle is correctly fitted. If the nozzle becomes blocked with particles of milk residue or is incorrectly assembled, a danger can arise during use whereby the nozzle may jump off.

- When using for the first time, remove the protective cover from the Professional Cappuccino Frother (15) (Fig. 6). The protective cover is used only during transport as protection to prevent the ingress of contaminated materials.
- Remove the milk pipe from the Welcome Pack and connect it to the Professional Cappuccino Frother (15).
- Insert the other end of the milk pipe into a Tetra Pak of milk or connect it to a milk container (Fig. 7).
- Place a cup under the Professional Cappuccino Frother (15) (Fig. 7).



A useful addition is available for all lovers of milk specialties in the form of high-quality vacuum milk containers. They keep the milk cool the whole day long and are optimally suited to the design of your IMPRESSA. All original JURA accessories can be obtained from the specialist shop.

- Turn the selector switch of the Professional Cappuccino Frother (15) to the milk foam position (Fig. 19).
- **DISPLAY** READY
- Open the steam / hot water draw-off tap (14) (Fig. 12). The milk foam is prepared.
- The illuminated ring (2) is active.
- **DISPLAY** STEAM
- You can adjust the steam draw-off time individually by turning the rotary switch (1) until the required SEC are displayed.
- For example, **DISPLAY** 35 SEC
- If you do not change the steam draw-off time settings using the rotary switch (1), the machine will use the settings last adjusted.



Adjust the steam dispensing time to suit the size of your cup.

- During the steam draw-off operation, the message STEAM is displayed.
- When the steam quantity is reached, the message CLOSE TAP is displayed.
- Close the steam / hot water draw-off tap (14).
- **DISPLAY** READY



Due to the system design, steam can still escape and some milk may continue to drip before the TAP is closed.



At any time, you can abort steam dispensing early, by closing the tap for dispensing steam/hot water (14).

- Now, move your cup with the milk foam and place it under the coffee spout and dispense the required coffee product. (Fig. 8). Your Cappuccino is ready.

13.1 Dispensing Hot Milk with the Professional Cappuccino Frother



Turn the selector switch of the Professional Cappuccino Frother (15) to the milk range (Fig. 21). The procedure for dispensing hot milk is the same as the procedure for dispensing milk foam for Cappuccino (Chapter 13).

13.2 Cleaning of the Professional Cappuccino Frother



To ensure that the Professional Cappuccino Frother functions perfectly, you should rinse it with water each time after preparing milk.





You will not be prompted by your IMPRESSA to rinse the Professional Cappuccino Frother.

13.3 Rinsing the Professional Cappuccino Frother

- Carefully pull off the Professional Cappuccino Frother from your IMPRESSA.
- Dismantle the Professional Cappuccino Frother (15) into its individual parts (Fig. 16).
- Thoroughly rinse all parts of the nozzle under running water.
- Reassemble the Professional Cappuccino Frother (15) and refit it on to your IMPRESSA.

13.4 Cleaning the Professional Cappuccino Frother

 To ensure that the Professional Cappuccino Frother (15) functions perfectly, you should clean it daily if you have prepared milk foam or hot milk.

 You will not be prompted by your IMPRESSA to clean the Professional Cappuccino Frother (15).

 You can obtain the JURA Auto-Cappuccino Cleaner from the specialist shop.

- Place a receptacle under the Professional Cappuccino Frother (15) (Fig. 9).
- Fill a second receptacle with 2.5 dl of fresh water and add one capful of the Auto-Cappuccino Cleaner.
- Dip the milk pipe into the second receptacle with the Auto-Cappuccino Cleaner (Fig. 9).
- Turn the selector switch of the Professional Cappuccino Frother (15) to the milk position (Fig. 21) or to the milk foam position (Fig. 19).
- **DISPLAY** READY
- Open the steam / hot water draw-off tap (14) (Fig. 12).

- Draw steam until the receptacle with the Auto-Cappuccino Cleaner is empty.
This procedure cleans the Professional Cappuccino Frother and the milk pipe.



- Close the steam / hot water draw-off tap (14).

■ **DISPLAY** READY

 Before CLOSE TAP water may still escape the system.

- Fill the receptacle with 2.5 dl of fresh water.
Dip the milk pipe into the receptacle with the fresh water.
- Open the tap for dispensing steam/hot water (14) (Fig. 12) in order to draw steam.
- Draw steam until the receptacle with the fresh water is empty.
This procedure rinses the Professional Cappuccino Frother (15) and the milk pipe with fresh water.
- Cleaning of the Professional Cappuccino Frother (15) is now complete, your IMPRESSA is ready for use.

14. Switching off the IMPRESSA

 In order to ensure perfect operation, please don't switch off your IMPRESSA at the power switch (24) before all the symbols on the display (9) have gone off except for  (3).

■ **DISPLAY** READY

- Switch off the IMPRESSA using the ON/OFF key  (3).

■ **DISPLAY** RINSING

- An automatic rinsing operation is started.

■ **DISPLAY** 

Your IMPRESSA is in standby mode.

15. Programming

 When your IMPRESSA leaves the factory it is adjusted such that you can draw off coffee without having to change any settings. However, you can programme various parameters individually.

You can programme the following stages:

- Filter
- Water hardness
- Maintenance
- Aroma
- Temperature
- Time
- Automatic switch-on time
- Automatic switch-off time
- Draw-offs
- Language
- Display
- Exit

 To start programming, press the Rotary Switch (1) until **DISPLAY** FILTER -/√ appears

 **Rotary switch**
Turn the Rotary Switch to change the adjusted values or to select the next programming step.
Press the Rotary Switch to check the values adjusted or to save the values selected (Fig. 17).

15.1 Programming the filter

Refer to Chapter 5.1 «Inserting the filter».

15.2 Programming the water hardness

Refer to Chapter 4 «Adjusting the water hardness».

15.3 Maintenance menu

- **DISPLAY** READY
- Press the Rotary Switch (1) until **DISPLAY** FILTER -/√ appears
- The illuminated ring (2) is active.
- Turn the Rotary Switch (1) until **DISPLAY** MAINTENANCE appears
- Press the Rotary Switch (1)
- **DISPLAY** RINSE
- Turn the Rotary Switch (1) until the required program item appears on the display (9).
- **DISPLAY** e.g. RINSE, CLEAN, FILTER, DE-SCALE or EXIT
- **DISPLAY** e.g. CLEAN
- Press the Rotary Switch (1)
- The cleaning program starts.
- **DISPLAY** EMPTY TRAY
- Continue with Chapter 17 Cleaning, from point 3
- **DISPLAY** EMPTY TRAY

15.4 Programming the aroma INTENSIVE or STANDARD

 When the machine leaves the factory, the aroma is set to intensive. If requested it can also be set to Standard.

- **DISPLAY** READY
- Press the Rotary Switch (1) until **DISPLAY** FILTER -/√ appears
- The illuminated ring (2) is active.
- Turn the Rotary Switch (1) until Aroma is displayed.
- **DISPLAY** AROMA

- Press the Rotary Switch (1).
- **DISPLAY** INTENSIVE
- Turn the Rotary Switch (1) until the following message is displayed:
- **DISPLAY** STANDARD
- Press the Rotary Switch (1) to save the setting.
- **DISPLAY** AROMA
- Turn the Rotary Switch (1) until **DISPLAY** EXIT appears
- Press the Rotary Switch (1) to leave the programming mode.
- **DISPLAY** READY

15.5 Programming the temperature

- **DISPLAY** READY
- Press the Rotary Switch (1) until **DISPLAY** FILTER -/√ appears
- The illuminated ring (2) is active.
- Turn the Rotary Switch (1) until Temperature is displayed.
- **DISPLAY** TEMPERATURE
- Press the Rotary Switch (1).
- **DISPLAY** HIGH
- Turn the Rotary Switch (1) to change the temperature from HIGH to NORMAL (or vice versa).
- **DISPLAY** NORMAL
- Press the Rotary Switch (1) to save the setting.
- **DISPLAY** TEMPERATURE
- Turn the Rotary Switch (1) until **DISPLAY** EXIT appears
- Press the Rotary Switch (1) to leave the programming mode.
- **DISPLAY** READY

15.6 Programming the time



You must programme the time if you want to use the automatic switch-on function.

- **DISPLAY** READY
- Press the Rotary Switch (1) until **DISPLAY** FILTER -/√ appears
- The illuminated ring (2) is active.
- Turn the Rotary Switch (1) until TIME is displayed.
- **DISPLAY** TIME
- Now press the Rotary Switch (1) to start programming the time.
- **DISPLAY** --:--
- Turn the rotary Switch (1) to adjust the hours..
- **DISPLAY** 12:--
- Press the Rotary Switch (1) to confirm the hour settings and to activate the minutes.
- **DISPLAY** 12:--
- Turn the Rotary Switch (1) to select the minutes.
- **DISPLAY** 2:05
- Press the Rotary Switch (1) to save the setting.
- **DISPLAY** TIME
- Turn the Rotary Switch (1) until **DISPLAY** EXIT appears
- Press the Rotary Switch (1) to leave the programming mode.
- **DISPLAY** READY



If the machine is disconnected from power supply, the time must be programmed again.

15.7 Programming the automatic switch-on time

 You must programme the time (Chapter 15.6) if you want to use the automatic switch-on function (—:— = inactive).

- **DISPLAY** READY
- Press the Rotary Switch (1) until **DISPLAY** FILTER -/√ appears
- The illuminated ring (2) is active.
- Turn the Rotary Switch (1) until MACHINE ON is displayed.
- **DISPLAY** MACHINE ON
- Now press the Rotary Switch (1) to start programming the switch-on time.
- **DISPLAY** --:--
- Turn the Rotary Switch (1) to adjust the hours.
- **DISPLAY** 12:--
- Press the Rotary Switch (1) to confirm the hour settings and to activate the minutes.
- **DISPLAY** 12:--
- Turn the Rotary Switch (1) to select the minutes.
- **DISPLAY** 12:05
- Press the Rotary Switch (1) to save the setting.
- **DISPLAY** MACHINE ON
- Turn the Rotary Switch (1) until **DISPLAY** EXIT appears
- Press the Rotary Switch (1) to leave the programming mode.
- **DISPLAY** READY

15.8 Programming the automatic switch-off time

 You can programme your coffee machine such that it will switch off automatically after a certain time. You can programme the switch-off time in a range between 0.5 and 9 hours, or select —:— (i.e. inactive).

- **DISPLAY** READY
- Press the Rotary Switch (1) until **DISPLAY** FILTER -/√ appears
- The illuminated ring (2) is active.
- Turn the Rotary Switch (1) until OFF AFT. HR is displayed.
- **DISPLAY** OFF AFT. HR
- Now press the Rotary Switch (1) to start programming the switch-off time. Switch-off time OFF AFT. HR
- **DISPLAY** 5.0 HR
- Turn the Rotary Switch (1) to adjust the hours.
- **DISPLAY** 1.0 HR
- Press the Rotary Switch (1) to save the setting.
- **DISPLAY** OFF AFT. HR
- Turn the Rotary Switch (1) until **DISPLAY** EXIT appears
- Press the Rotary Switch (1) to leave the programming mode.
- **DISPLAY** READY

15.9 Cup counter

This function is available with the following types of coffee:

- a) 1 LARGE CUP ☐
- b) 1 COFFEE ☐
- c) 1 ESPRESSO ☐
- d) 1 powder coffee
- e) 2 COFFEE

- **DISPLAY** READY
- Press the Rotary Switch (1) until **DISPLAY** FILTER -/√ appears
- The illuminated ring (2) is active.
- Turn the Rotary Switch (1) until **DISPLAY** CUPS MADE appears
- Press the Rotary Switch (1)
- **DISPLAY** 100
- Press one of the draw-off keys ☞ / ☞ / ☞ to check the number of individual cups made.
- E.g press draw-off key 1 cup of coffee ☞ (5).
- **DISPLAY** 20



You can check the number of pre-ground cups of coffee by opening the filler funnel for pre-ground coffee (11).

- Touch one of the symbols ☞ / ☞ / ☞ to check how often you made 2 cups of coffee.
- To quit press the Rotary Switch (1).
- **DISPLAY** CUPS MADE
- Turn the Rotary Switch (1) until **DISPLAY** EXIT appears
- Press the Rotary Switch (1) to leave the programming mode.
- **DISPLAY** READY

15.10 Programming the language

- **DISPLAY** READY
- Press the Rotary Switch (1) until **DISPLAY** FILTER -/√ appears
- The illuminated ring (2) is active.
- Turn the Rotary Switch (1) until LANGUAGE is displayed.

- **DISPLAY** LANGUAGE
- Now press the Rotary Switch (1) to start programming the item LANGUAGE.
- Turn the Rotary Switch (1) until the required language is displayed.
- For example **DISPLAY** ENGLISH
- Press the Rotary Switch (1) to save the setting.
- **DISPLAY** LANGUAGE
- Turn the Rotary Switch (1) until **DISPLAY** EXIT appears
- Press the Rotary Switch (1) to leave the programming mode.
- **DISPLAY** READY

15.11 Programming Display 24H/AM/PM

- **DISPLAY** READY
- Press the Rotary Switch (1) until **DISPLAY** FILTER -/√ appears
- The illuminated ring (2) is active.
- Turn the Rotary Switch (1) until **DISPLAY** DISPLAY appears
- Press the Rotary Switch (1)
- **DISPLAY** ML/OZ appears
- Turn the Rotary Switch (1) until **DISPLAY** 24H/AM PM appears
- Press the Rotary Switch (1)
- **DISPLAY** e.g. 24H
- Select a setting of your choice.
- Press the Rotary Switch (1) to save the setting.
- **DISPLAY** DISPLAY

- Turn the Rotary Switch (1) until **DISPLAY** EXIT appears
- Press the Rotary Switch (1) to leave the programming mode.
- **DISPLAY** READY

15.12 Programming the display for ML/OZ

- **DISPLAY** READY
- Press the Rotary Switch (1) until **DISPLAY** FILTER –/✓ appears
- The illuminated ring (2) is active.
- Turn the Rotary Switch (1) until **DISPLAY** DISPLAY appears
- Press the Rotary Switch (1)
- **DISPLAY** ML/OZ appears
- Press the Rotary Switch (1)
- **DISPLAY** e.g. ML
- Select a setting of your choice.
- Press the Rotary Switch (1) to save the setting.
- **DISPLAY** DISPLAY
- Turn the Rotary Switch (1) until **DISPLAY** EXIT appears
- Press the Rotary Switch (1) to leave the programming mode.
- **DISPLAY** READY

15.13 Exit programming mode

- **DISPLAY** READY
- Press the Rotary Switch (1) until **DISPLAY** FILTER –/✓ appears
- The illuminated ring (2) is active.

- Turn the Rotary Switch (1) until **DISPLAY** EXIT appears
- Press the Rotary Switch (1) to leave the programming mode.
- **DISPLAY** READYM

16. Maintenance

16.1 Filling in water

- **DISPLAY** FILL
WATER

 If this information is displayed, drawing off products is no longer possible. Refill water as described in Chapter 2.3.

- **DISPLAY** READY

 The water tank should be rinsed daily and refilled with fresh water. Only fill in fresh, cold water. Never fill in milk, mineral water or other liquids.

16.2 Emptying the coffee grounds container

- **DISPLAY** EMPTY
GROUNDS

 If this message appears on the display, you can no longer draw off coffee. You must empty the coffee grounds container (18) first (Fig. 13).

- Carefully take out the drip tray (20), it is filled with water.
- **DISPLAY** NO
TRAY
- Insert the empty and clean trip tray (20) again.
- **DISPLAY** READY

 The red water level indicator appears when the drip tray (20) is full.

16.3 Drip tray missing

- **DISPLAY** NO TRAY
- If this information is displayed, the drip tray (20) is not installed properly or was not installed at all.
- Insert the drip tray (20).
- **DISPLAY** READY

16.4 Fill coffee beans

- **DISPLAY** FILL BEANS
- Refill beans as described in Chapter 2.4.

 The message REFILL BEANS will disappear after you draw off your next cup of coffee.

 We recommend that you clean the bean tank regularly before refilling beans, using a dry cloth. Before cleaning the tank, switch off the IMPRESSA.

16.5 Replacing the filter

 After drawing off 50 litres, the filter cartridge will be used up. A message requesting you to replace the filter will appear on the display.

Refer to Chapter 5.2 «Replacing the filter».

16.6 Cleaning the IMPRESSA

After 200 draw-off operations or after 80 rinsing operations, the IMPRESSA must be cleaned. A message appears on the display, telling you to start the cleaning programme. You can still draw off coffee or hot water/steam. However, we recommend that you should clean the machine (Chapter 17) within the next few days.

- **DISPLAY** CLEAN MACHINE / MACHINE READY

16.7 IMPRESSA calcified

During operation, the machine will calcify. The degree of scaling depends on the hardness of the water in your region. The machine will inform you when de-scaling is required. You can still draw off coffee or hot water/steam. However, we recommend that you should de-scale the machine (Chapter 18) within the next few days.

- **DISPLAY** MACHINE CALCIFIED / MACHINE READY

16.8 General cleaning instructions

- Never use scratching objects, pan cleaners, cleaning sponges or caustic chemicals to clean the machine.
- Wipe off the case on the inside and outside using a soft, moist cloth.
- Clean the replaceable hot water nozzle after each use.
- To ensure that the Professional Cappuccino Frother functions perfectly, you should rinse it with water each time after preparing milk.
- To ensure that the Professional Cappuccino Frother functions perfectly, you should clean it daily if you have prepared milk.
- The water tank should be rinsed daily and refilled with fresh water.

 If the water tank shows signs of scaling, remove the scaling using a commercial de-scaling agent. Take out the water tank (Fig. 4).

 Remove the CLARIS plus filter cartridge, if installed, before de-scaling the water tank.

16.9 Emptying the system

Precondition: IMPRESSA switched off

 This operation is required to protect the IMPRESSA against frost damage during transports.

■ Place a receptacle under the Professional Cappuccino Frother (15) (Fig. 10).

■ Turn the selector switch of the Professional Cappuccino Frother (15) to the steam position (Fig. 20).

■ **DISPLAY** OPEN TAP

■ Press the Rotary Switch (1)

■ **DISPLAY** EMPTYING

■ **DISPLAY** CLOSE TAP

■ The IMPRESSA is switched off.

17. Cleaning

Your IMPRESSA features an integrated cleaning program. The cleaning operation will take some 15 min.

 Original JURA cleaning tablets which are specially designed for the cleaning program of your IMPRESSA are available at your authorized dealer. Please note that machine defects or residues in the water cannot be excluded if you use inappropriate cleaning agents.

 Once started, the de-scaling operation must not be interrupted!

 After each cleaning operation the filler funnel for pre-ground coffee should be cleaned (11).

■ **DISPLAY** READY
CLEAN

■ Touch the ☼ symbol (7).

■ **DISPLAY** EMPTY
TRAY

■ Empty the tray (20).

■ **DISPLAY** NO
TRAY

■ Insert the tray (20) again.

■ Remove the drip grate (19).

■ Put a container (1 l, Fig. 11) under the adjustable coffee spout (17).

■ **DISPLAY** PRESS
MAINT.

■ Touch the ☼ symbol (7).

■ **DISPLAY** CLEANING

■ **DISPLAY** FILL
TABLET

■ Fill in the tablet (see Fig. 14)

■ **DISPLAY** PRESS
MAINT.

■ Touch the ☼ symbol (7).

■ **DISPLAY** CLEANING

■ **DISPLAY** EMPTY
TRAY

- **DISPLAY** NO TRAY
- **DISPLAY** READY
- Wipe coffee powder tank with a dry cloth after the cleaning program has finished.
- The cleaning operation was completed successfully.

17.1 Cleaning without display request

- Press the Rotary Switch (1) until **DISPLAY** FILTER –/✓ appears.
- Turn the Rotary Switch (1) until **DISPLAY** MAINTENANCE appears.
- Press the Rotary Switch (1) to confirm.
- **DISPLAY** RINSE
- Turn the Rotary Switch (1) until **DISPLAY** CLEAN appears.
- Press the Rotary Switch (1) again to confirm.
- **DISPLAY** EMPTY TRAY
- The program “Clean” is now active. Now proceed as described in Chapter 17 from **DISPLAY** EMPTY TRAY onwards.

18. De-scaling

Your IMPRESSA features an integrated de-scaling program. The cleaning operation will take some 40 min.

! Original JURA de-scaling tablets which are specially designed for the de-scaling program of your IMPRESSA are available at your authorized dealer. Please note that machine defects or residues in the water cannot be excluded if you use inappropriate de-scaling agents.

! If the IMPRESSA needs de-scaling, the corresponding message is displayed. You can still draw off coffee or hot water/steam and start the de-scaling program later. Before starting the de-scaling program, the machine must be switched off. Once started, the de-scaling operation must not be interrupted.

➔ When using the de-scaling agent, immediately remove any splashes or drips from sensitive surfaces, i.e. natural stone and wooden surfaces, or take appropriate precautions.

➔ In any case wait until the de-scaling agent is used up and the tank is empty. Never refill de-scaling agent.

- **DISPLAY** MACHINE CALCIFIED / MACHINE READY
- Remove the Professional Cappuccino Frother (15).
- Touch the ☼ symbol (7).
- **DISPLAY** EMPTY TRAY
- Empty the tray (20).
- **DISPLAY** NO TRAY
- Insert the tray (20) again.
- **DISPLAY** AGENT IN TANK

Completely dissolve the content of one blister (3 tablets) in a jug containing 0.5 litres of water, and fill the mixture in the water tank. Reinstall the water tank.

- **DISPLAY** OPEN TAP AGENT IN TANK

- Place a receptacle under the hot water spout (Fig. 18).
- Open the steam / hot water draw-off valve (14) (Fig. 12).

- **DISPLAY** DE-SCALING

- **DISPLAY** CLOSE TAP

- Close the steam / hot water draw-off tap (14).

- **DISPLAY** DE-SCALING

- **DISPLAY** EMPTY TRAY

- Empty the tray (20).

- **DISPLAY** NO TRAY

- Insert the tray (20) again.

- **DISPLAY** FILL WATER



Rinse the water tank thoroughly and fill it with cold, fresh tap water. Install it again.

- **DISPLAY** OPEN TAP

- Open the steam / hot water draw-off tap (14) (Fig. 12).

- **DISPLAY** DE-SCALING

- **DISPLAY** CLOSE TAP

- After you have closed the steam / hot water draw off tap (14), the following message is displayed

- **DISPLAY** DE-SCALING

- **DISPLAY** EMPTY TRAY

- Empty the tray (20).

- **DISPLAY** NO TRAY

- Insert the tray (20) again.

- **DISPLAY** PRESS MAINT.

- Touch the symbol (7).

- **DISPLAY** RINSING

- **DISPLAY** READY

- The de-scaling operation was completed successfully.

18.1 Decalcifying without display request



Decalcifying without display request is only possible if the CLARIS plus filter is NOT programmed.

- Press the Rotary Switch (1) until **DISPLAY** FILTER – appears.

- Turn the Rotary Switch (1) until **DISPLAY** MAINTENANCE appears.

- Press the Rotary Switch (1) to confirm.

- **DISPLAY** RINSE

- Turn the Rotary Switch (1) until **DISPLAY** DECALC. ON appears.

- Press the Rotary Switch (1) again to confirm.

- **DISPLAY** EMPTY TRAY

- The program “De-scale” is now active. Now proceed as described in Chapter 18 from **DISPLAY** EMPTY TRAY onwards.

19. Disposal



Please dispose of old machines in an environmentally neutral way.

Old machines contain valuable materials capable of being recycled which should be salvaged for recycling. Please therefore dispose of old machines via suitable collection systems.

20. Tips for perfect coffee

Height-adjustable coffee spout (17)

You can adjust the height of the coffee spout to the size of your cups (Fig. 3)

Grinding degree

Refer to Chapter 2.5 «Adjusting the grinding gear».

Preheating cups

You can preheat the cups using hot water or steam. The smaller the coffee you want to draw off, the more important preheating is.

Sugar and cream

Stirring coffee/tea will result in heat being released. Adding refrigerated cream or milk will reduce the temperature of the coffee significantly.

21. Messages

DISPLAY	Cause	Remedy
FILL WATER	Water tank is empty.	Refill water
	Float defective	Rinse or de-scale water tank
FILL BEANS	Bean tank is empty.	Refill beans
	Although you have refilled beans, the message still appears.	Draw off a cup of coffee. The message will disappear only after you have drawn off a cup of coffee
EMPTY GROUNDS	Coffee grounds container full	Empty coffee grounds container
	Tray reinstalled too early after emptying	Wait 10 sec. before reinstalling the tray
NO TRAY	Drip tray not installed properly or missing	Install tray properly
CLEAN MACHINE / MACHINE READY	Cleaning required	Start cleaning programme (Chapter 17)
MACHINE CALCIFIED / MACHINE READY	De-scaling required	Start de-scaling programme (Chapter 18)
CHANGE FILTER / MACHINE READY	Filter used up	Replace filter (Chapter 5.2)
ERROR	General fault	<ul style="list-style-type: none">- switch off- disconnect from mains supply- Connect IMPRESSA to power supply- Switch on IMPRESSA - Have IMPRESSA checked by JURA Service

22. Problems

Problem	Cause	Remedy
Very loud noise coming from the grinding gear	Foreign body in grinding gear	Drawing off pre-ground coffee still possible Have IMPRESSA checked by JURA Service
Too little foam when frothing the milk	Professional Cappuccino Frother has become dirty	Clean the Professional Cappuccino Frother (Chapter 13)
	Individual parts of the Professional Cappuccino Frother are incorrectly assembled	Check correct assembly of the Professional Cappuccino Frother
Coffee only drips from the coffee spout	Grinding degree too fine	Coarser grinding gear adjustment
	Pre-ground coffee too fine	Use a coarser pre-ground coffee

High-frequency, electromagnetic interference may influence the display. Drawing off coffee is possible at any time.

If the messages or problems still persist, please contact your local authorized dealer or JURA Elektroapparate AG.

23. Legal information

These operating instructions contain all the information required for using, operating and maintaining the machine properly.

Knowledge of and compliance with the specifications contained in these operating instructions is required for using the machine safely as well as for operational safety and safety during maintenance.

These operating instructions cannot cover any conceivable application. The machine was designed for private household use.

Additionally we point out that the content of these operating instructions does not form part of any previous or existing agreement, consent or al legal relationship nor does it constitute a change of such an agreement, consent or legal relationship. Any obligations to be fulfilled by JURA Elektroapparate AG are stipulated in the corresponding purchase contract, which also contains the full and solely applicable warranty stipulations. These contractual warranty stipulations are neither extended nor limited by the specifications contained in these operating instructions.

The operating instructions contain information, protected by Copyright. Photocopying or translations into other languages shall not be permissible without JURA Elektroapparate AG's written approval.

24. Technical data

Voltage:	230V AC
Power:	1450 W
Intensity of current:	10 A
Safety check:	
Energy consumption Standby:	approx. 3.5 Wh
Energy consumption «Ready for draw-off» mode:	approx. 11.5 Wh
Pump pressure:	static, max. 15 bar
Water tank:	1.9 litres
Bean tank capacity:	200gr
Coffee grounds container capacity :	max. 16 portions
Length of cable:	approx. 1.1 m
Weight:	9.1 kg
Size (WxHxD):	28 x 34.5 x 44.5 cm

The machine complies with the following EU directives:

73/23/EEG dated 19/02/1973 "Low Voltage Directive" including Modification Directive 93/336/EEG

89/336/EEG dated 03/05/1989 "EMC Directive" including Modification Directive 92/31/EEG