



Powered by  GREE



Model No.	Reference No.
SG-PAC-12E1	(KY-120E1)
SG-PAC-12E1HP	(KY-120E1HP)

12,000 BTU Portable Air Conditioner **Operating Instructions**



Powered by  GREE

Thank you for choosing a Soleus Air Powered by Gree Portable Air Conditioner. This owner's manual will provide you with valuable information necessary for the proper care and maintenance of your new product. Please take a few moments to thoroughly read the instructions and familiarize yourself with all the operational aspects of your new Portable Air Conditioner.

For your own records, please attach a copy of your sales receipt to this manual. Also, write the store name/location, date purchased, and serial number below:

Store Name: _____

Location: _____

Date Purchased: _____

Serial Number (located on back of unit): _____

IMPORTANT INSTRUCTIONS

Before installing and using your portable air conditioner, please read this owner's manual carefully. Store this manual in a safe place for future reference.

- 1) Always place the unit on a level surface.
- 2) Never use or store gasoline or other flammable vapor or liquid near this unit unless instructed by this manual.
- 3) Maintain at least 12 inches (50 cm) clearance space around this unit. Do not block or cover air inlet or outlet grilles.
- 4) The unit must be connected to a correctly grounded power supply.
- 5) Do not start or stop the unit by inserting or pulling out the power plug.
- 6) Do not use an adapter plug or extension cord.
- 7) Do not use the unit in the immediate surroundings of a bath, a shower or a swimming pool.
- 8) Do not insert anything into the air outlet. Do not obstruct air inlet or outlet grills unless instructed by this manual.
- 9) Do not let children play near this unit.
- 10) Always inspect the cord for signs of damage before use. If the power cord is damaged, it must be replaced by the manufacturer or a qualified service technician.
- 11) When cleaning the unit, always turn the unit off and unplug the power cord.

PACKAGE CONTENTS

Portable Air Conditioner
Exhaust Hose (1)
Front Exhaust Hose Adapter (1)
Window Kit Adapter (1)
Rear Exhaust Hose Adapter (1)
Remote Control & AAA Batteries (2 batteries)
Window Kit - 3 Sliding Panels (1 single hose panel, 2 extension panels)
Owner's Manual

SPECIFICATIONS

- The cooling capacity is measured at an ambient temperature of DB 86 °F, WB 78 °F.
- Noise level is measured at a distance of 3.28 ft away from the front of the unit, when the unit is in cooling mode.
- Power consumption is measured when the fan runs at the highest speed setting.
- These specifications are for reference only. For actual data, please refer to the rating label on the back of the unit.
- If the environment temperature is higher than the max operating temperature or lower than the minimum operating temperature, the air conditioner may not work properly.
- Dehumidifier mode works when ambient temperatures are between 61°F - 86°F
- Air Conditioner mode operates up to an ambient temperature of 95°F.

Model Number	SG-PAC-12E1	SG-PAC-12E1HP (with Heat)
Reference Number	KY-100E1	KY-100E1HP
Power Supply (Ph/V/Hz)	1/115/60Hz	1/115/60Hz
Dehumidifying Capacity (Pints/Day)	81.6	81.6
Rated Cooling Capacity (BTU/h)	12,000	12,000
Rated Heating Capacity (BTU/h)	-	10,500
Cooling Power Input (Watts)	1465	1465
Heating Power Input (Watts)	-	1200
Rated Current Cooling (Amperage)	13	13
Rated Current Heating (Amperage)	-	10.6
Noise Level (dBA) - H/M/L	55/53/51	55/53/51
Air Flow - H/M/L (CFM)	235/205/175	235/205/175
Product Dimensions (W" x H" x D")	17.75 x 33.125 x 17.125	17.75 x 33.125 x 17.125
Product Weight (Lbs)	80	80
Refrigerant Type	R-410A	R-410A

LCDI POWER CORD AND PLUG

This air conditioner is equipped with an LCDI (Leakage Current Detection and Interruption) power cord and plug as required by US National Electric Code 440.65. This cord consists of a length of shielded flexible cord with no termination on the load side and a LCDI attachment plug on the line side.

The LCDI power cord and plug will remove the supply source via electrical disconnect (circuit trip) if the nominal current leakage between the cord shield and either load conductor exceeds a predetermined value. The cord will remain de-energized until the device has been manually reset. This is intended to reduce the risk of a fire in the power cord or combustible materials nearby. The cord shields are not grounded and they must be considered a shock hazards if exposed. The cord shield must not be connected to ground or to any exposed metal.

The test and reset buttons on the LCDI Plug are used to check if the plug is functioning properly. To test:

1. Plug power cord into wall outlet
2. Press TEST Button, circuit should trip, cutting power to the air conditioner
3. Press RESET button for use

If a test is performed and the indicator light remains ON, current leakage has been detected. Do not use the air conditioner or attempt to reset the LCDI Plug. Contact Soleus Air Powered by Gree Customer Service for troubleshooting recommendations.

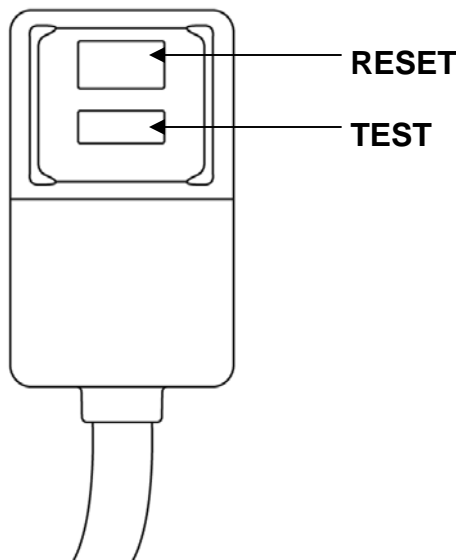

WARNING:

1. DO NOT press the TEST button while the air conditioner is operating.
2. The TEST and RESET buttons should not be used as “ON” and “OFF” switches.
3. The cord and plug are not intended to offer protection to externally connected loads or supply circuits.
4. The cord and plug are intended for indoor use only.

PRODUCT DIAGRAM

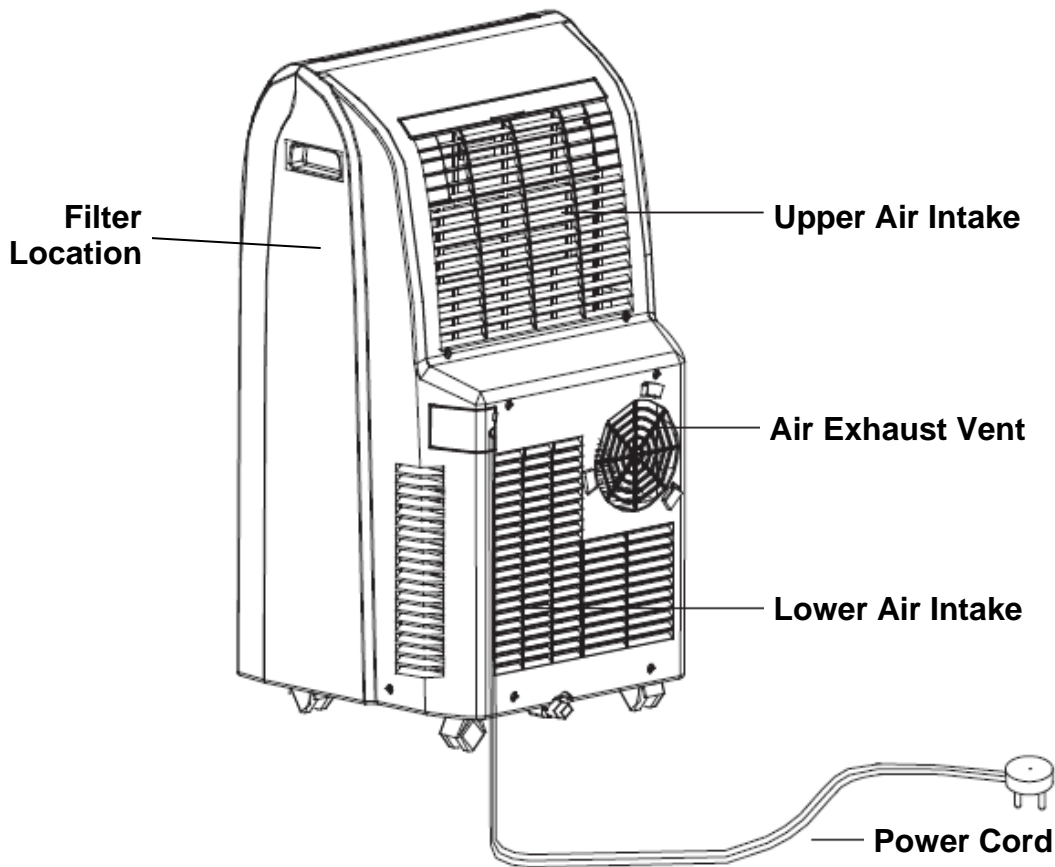
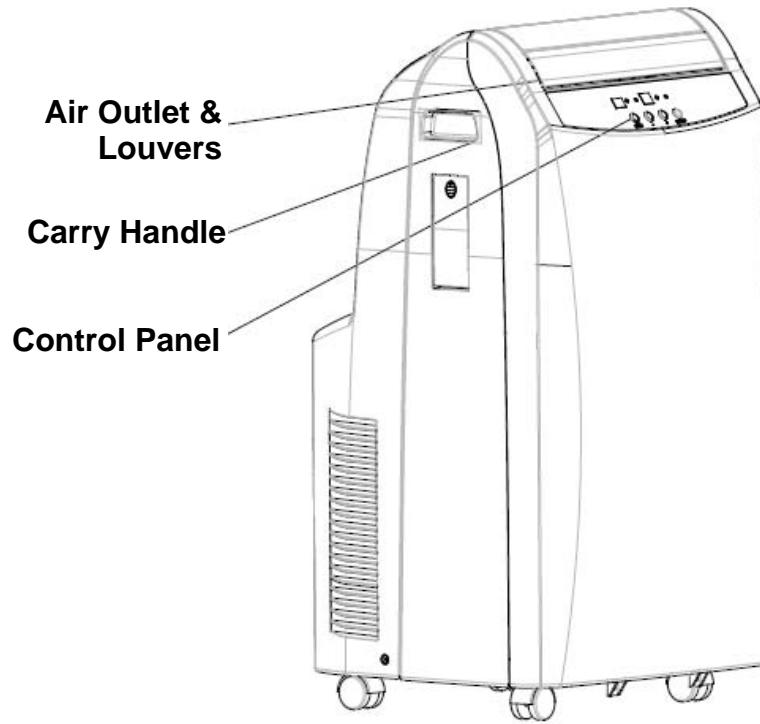

PARTS & WINDOW KIT ASSEMBLY

PARTS

EXHAUST HOSE & ADAPTERS

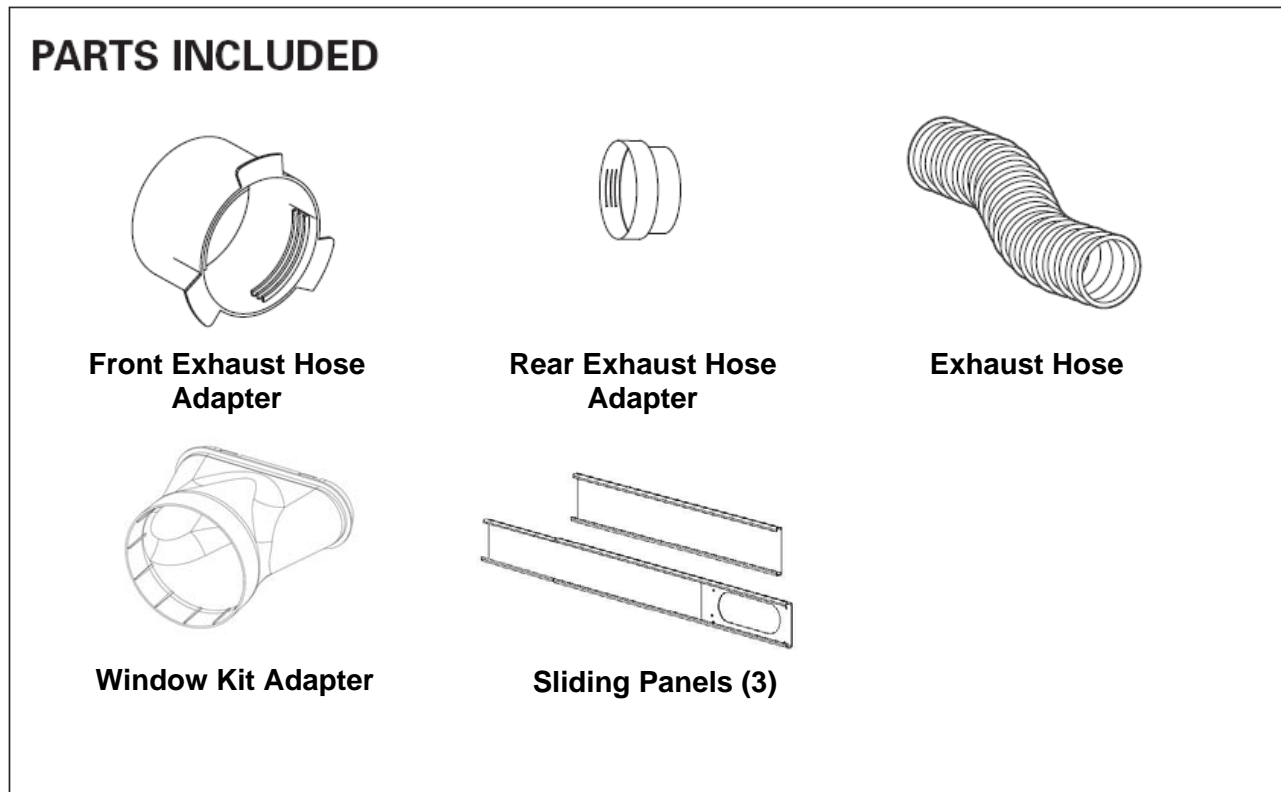

ASSEMBLY & INSTALLATION

INSTALLATION

When the unit is operating as an air conditioner or dehumidifier, the window kit and exhaust hose must be installed. When the unit is operating in fan mode, the window kit and exhaust hose do not need to be installed .

MOUNTING THE EXHAUST HOSE

- Choose a suitable location, near a grounded electrical outlet and suitable window or door. Remove packaging and locate components.
- Extend both ends of the exhaust hose approximately 6 inches.
- Screw the REAR and FRONT Exhaust Hose Adapters onto each end of the exhaust hose. Once both adapters are attached, attach the Window Kit Adapter to the REAR Exhaust Hose Adapter.
- Connect the FRONT Exhaust Hose Adapter to the back of your portable air conditioner.
- Attach the Window Kit Adapter to the window kit.
- For maximum efficiency bend the exhaust hose as little as possible once installation is complete.

SINGLE HOSE WINDOW KIT INSTALLATION

Installation of the Venting Kit FOR SINGLE HOSE PORTABLE AIR CONDITIONERS

Innovative products for a cleaner,
more comfortable world.



The venting kit must be installed in order for the unit to work correctly in the air conditioning mode. The venting kit should not be used while the unit is heating or fanning.

The window kit has been designed to fit into most vertical and horizontal window openings. The window kit can also be used in a sliding door.

1. Choose a suitable location, near a grounded electrical outlet and a suitable window or door. Remove packaging and locate components. (figure a)
2. Slide the exhaust connector over the discharge opening on the back of the unit. (figure b)
3. Connect the exhaust hose to the exhaust connector, aligning the fitted groove. (figure c)
4. Open the window or door and adjust the length of the window kit to fit the opening. (figure d) If necessary, mark the kit and cut one end down to properly fit the opening. (figures e & f)
5. Attach the window kit adapter to the window kit. (figure g)
6. Place the window kit back into the window and attach the exhaust hose to the window kit adapter. (figures h & i) Close the window tightly. (figure j) Your Portable Air Conditioner is now ready to cool!

NOTE: *When using the venting system, keep the exhaust hose as straight as possible. The exhaust hose can be shortened, but it is not recommended to increase the length of the exhaust hose. Do not use an extension cord with your portable air conditioner.*

This installation is OK

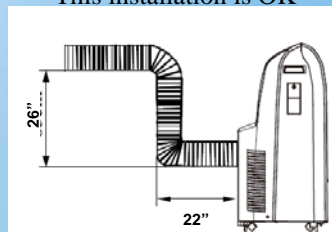

The is a poor installation



When installing the exhaust hose, try and keep it as flat as possible. The less angles and bends in the hose, the better the unit will perform. If bending or an angle is necessary, use single 90° angles like the pictures above. Multiple bends will decrease performance and efficiency

CONTROL PANEL

SG-PAC-12E1

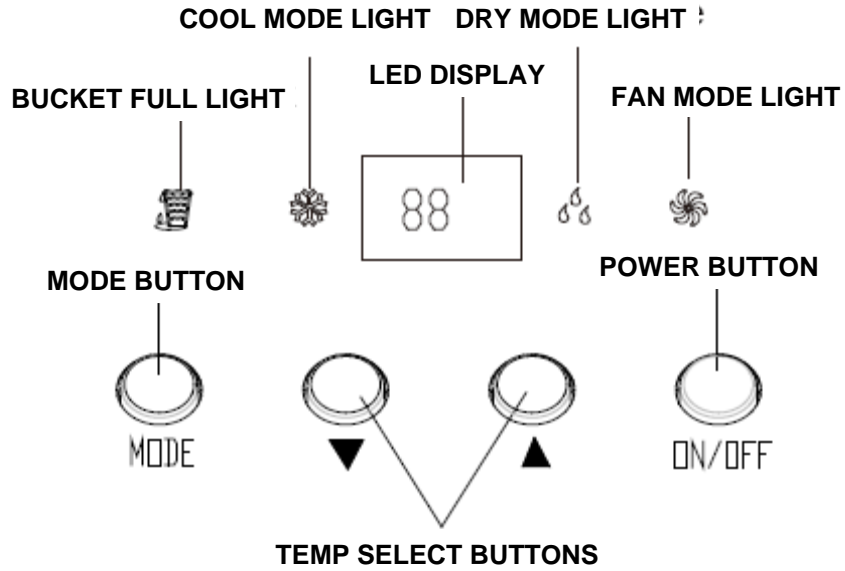

SG-PAC-12E1HP

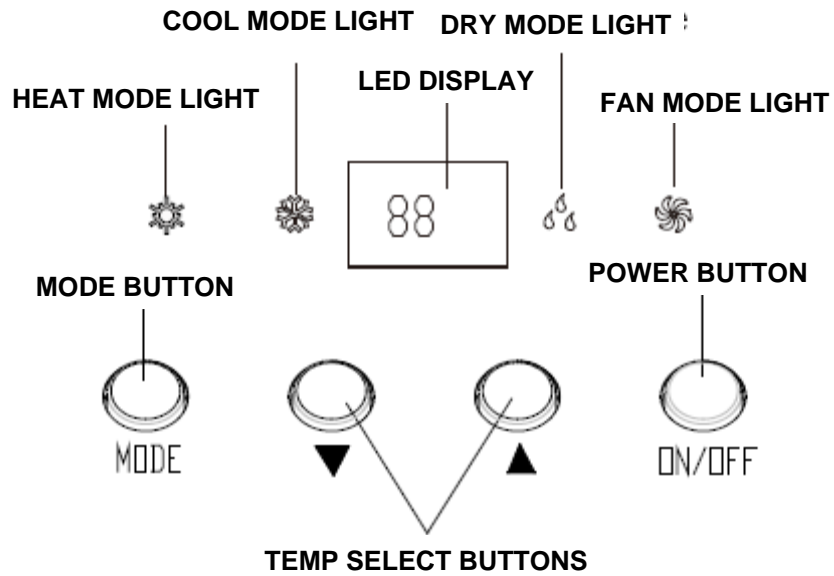

CONTROL PANEL FUNCTIONS

CONTROL PANEL OPERATING INSTRUCTIONS

- 1) **Power On and Off** - Press the **POWER** button once to manually turn the unit on. Press the **POWER** button once more to turn the unit off.
- 2) **Mode Selection** - Press the **MODE** Button repeatedly to cycle between the different modes: Air Conditioner, Dehumidifier (DRY), Fan only, and Heater mode (NOTE: Heater mode is only available on the SG-PAC-12E1HP). Each press of the **MODE** button will light up a different mode icon on the control panel. The exhaust hose and window kit must be installed when the unit is in Air Conditioner, Dehumidifier (DRY), or Heater (SG-PAC-12E1HP only) mode. When using the unit as a fan, it is not necessary to keep the exhaust hose and window kit connected to the unit.
- 3) **Temperature** - Select the desired temperature by pressing either ▼ or ▲ key when using the unit in Cooling or Heating (SG-PAC-12E1HP only) mode. The digital thermostat will display the set temperature.
- 4) **Bucket Full** - When the unit cannot evaporate the collected moisture fast enough, the excess water will collect in a backup water tank located inside the unit. The Bucket Full icon (SG-PAC-12E1) or Heat Mode icon (SG-PAC-12E1HP) will light up if this occurs. The unit will then beep 8 times and the LED display will show “H8”. The compressor will now shut off. You should now drain the excess water from the unit. To do this, get a small pan and place it under the drain plug on the bottom of the back of the unit. Remove the plug and slightly tilt the unit backwards to drain the water into the pan.

REMOTE CONTROL OPERATING INSTRUCTIONS

SIGNAL TRANSMITTER



REMOTE CONTROL

ON/OFF

ON/OFF BUTTON

- Press the **ON/OFF (POWER)** button once to manually turn the unit on. Press the Power button once more to turn the unit off.

MODE

MODE BUTTON

- Press the **MODE** Button repeatedly to cycle between the different modes.



AUTO

COOL

DRY

FAN

HEAT

NOTE: Heat Mode is only available on SG-PAC-12E1HP

- / +

- / + BUTTONS

- When the unit is in Air Conditioner or Heater (SG-PAC-12E1HP) mode you can select your desired temperature. Press the **TEMP SELECT** buttons (+ or -) to select your desired temperature setting. The temperature on the LCD display on the remote control will increase or decrease accordingly. Hold the +/- buttons for two seconds to rapidly increase or decrease the temperature. Temp. range is 61°F—86°F.

FAN

FAN BUTTON

- Press the Fan Speed button to change fan speeds.

Fan Speeds:



Low Speed

Medium Speed

High Speed

NOTE: When the unit is in Dehumidifier (DRY) mode, the fan speed is not adjustable.



Vertical Swing BUTTON

- Press the Up and Down Swing Button to turn on and off the vertical swing mode. In vertical swing mode, the louvers will rotate up and down to circulate more air.
- When the unit is off, press the Up and Down Swing Button and “+” at the same time to enable stationary swing mode. Stationary Swing mode allows for more control over the way the louvers swing up and down. The Swing icon on the Remote LCD will blink twice when this is



Blinks for 2 Seconds

- In Stationary Swing mode, press the Up and Down Swing Button to change the swing pattern per below:



- Disable Stationary Swing Mode by pressing the Up and Down Swing Button and “+” button at the same time. The Swing Icon on the Remote LCD will blink twice when this is disabled.

REMOTE CONTROL OPERATING INSTRUCTIONS



REMOTE CONTROL

HEALTH|SAVE

HEALTH|SAVE BUTTON

- The Health Function is not available on this unit.
- Press the Save button to automatically rotate through the different speeds. To disable Save mode and pick your own fan speed, press the Save button again.

TEMP

TEMP BUTTON

- Press the TEMP button to display the current set temperature or the actual room temperature. With each press of the TEMP button the display will cycle back and forth.

TIMER

TIMER BUTTON

- **Auto-on Timer:** When the air conditioner is off, it can be set to automatically turn on in 30 minutes to 24 hours at the previous set mode and fan setting. To set the Auto-on Timer, press the **TIMER** button on the unit or remote control. Each touch of the +/- buttons on the remote will change the timer setting in 30 minute increments (.5 hours). HOUR ON/OFF icon will blink when the Auto-on Timer is being set. Once the timer is set, press the **TIMER** button once more to save the setting.
- **Auto-off Timer:** When the air conditioner is on, it can be set to automatically turn off in 30 minutes to 24 hours. To set the Auto-off Timer, press the **TIMER** button on the remote control. Each touch of the +/- buttons on the remote will change the timer setting in 30 minute (.5 hour) intervals. HOUR ON/OFF icon will blink when the Auto-off Timer is being set. To cancel the timer, press the **ON/OFF** button. Once the timer is set, press the **TIMER** button once more to save the setting. Press the **ON/OFF** button to clear a time setting.



HORIZONTAL SWING BUTTON

- Press the Horizontal Swing Button to turn on and off the Horizontal swing mode. In horizontal swing mode, the louvers will rotate left and right to circulate more air. (This function is not available on this unit)

TURBO

TURBO BUTTON

Press the Left and Right Swing Button to turn on and off the Horizontal swing mode. In horizontal swing mode, the louvers will rotate left and right to circulate more air. (This function is not available on this unit)

REMOTE CONTROL OPERATING INSTRUCTIONS

REMOTE CONTROL



SLEEP

SLEEP BUTTON

- Press the SLEEP mode button to engage SLEEP mode.. This feature limits compressor usage and enhances energy savings by adjusting the set temperature while you are sleeping. Press the SLEEP button once more to disable Sleep Mode. Sleep Mode is not available in Auto or Fan Modes.
- In Cooling or Dehumidifier (DRY) modes: When sleep mode is selected the set temperature will automatically increase 2°F after 1 hour. After 2 hours, the set temperature will increase another 2°F for a total increase of 4°F.
- In Heating mode (SG-PAC-12E1HP only): When sleep mode is selected the set temperature will automatically decrease 2°F after 1 hour. After 2 hours, the set temperature will decrease another 2°F for a total increase of 4°F.

X-FAN

X-FAN BUTTON

- Press the X-FAN button to enable the X-Fan function. When enable, X-Fan will force the fan to remain on once the unit is powered down. The fan stays on to dry out any remaining moisture in the unit to help minimize mold or bacteria growth. X-Fan cannot be set under Auto, Fan, or Heat (SG-PAC-12E1HP only) modes.

LOCK

LOCK FUNCTION

- Press “+” and “-” buttons together at the same time to lock the remote keyboard. Do this again to unlock.

LIGHT

LIGHT BUTTON

- Press the LIGHT button to turn the on the display Light. A small Light bulb icon will light up on the remote control display.

AUTO

AUTO MODE

- Press the MODE button to select Auto Mode. Once Auto Mode is selected the unit will automatically choose the operating mode based on the current room temperature. The temperature will not be displayed on the LED in this mode.

TEMP MEASURE

CHANGE BETWEEN F° and C°

- When the unit is off, press the MODE and “-” button to change between F° and C°.

MAINTENANCE

Note: Make sure power is off and the power cord is not plugged into an electrical outlet prior to performing any maintenance on the unit.

Clean or replace filter - If the air filter is blocked with a dust, the airflow volume may decrease. It is recommended to clean the filter once every two weeks, or as needed.

- 1) Remove the filter from the filter compartment on the back of the unit.
- 2) Wash the air filter by immersing it gently into warm water with a neutral detergent. Rinse the filter and dry it thoroughly out of sunlight.
- 3) Slide the filter back into the filter compartment after it is thoroughly dried.
- 4) If the filter is torn or unusable, order a new filter by calling the customer service number on the warranty page of this manual.

Clean the unit Housing

- 1) Keep the unit from being exposed directly to the sun to prevent color fading.
- 2) Clean the surface with a damp cloth and dry it with a soft towel.

Storing the Unit for an Extended Period of Time or Transporting the unit

- 1) Empty any excess water by unplugging the water drainage stop in the back of the unit (located at the bottom).
- 2) Unplug the unit.
- 3) The unit should be stored in a cool dry place.

DISCLAIMER

ALL INFORMATION AND THE TECHNICAL SPECIFICATIONS PRESENTED IN THIS USER'S MANUAL ARE THE PRESENTATION OF THE MANUFACTURER. SOLEUS INTERNATIONAL HAS NOT CONDUCTED INDEPENDENT TEST TO THE INFORMATION AND THE SPECIFICATIONS PRESENTED HEREWITHIN.

TROUBLESHOOTING

PROBLEM	POSSIBLE CAUSES	SOLUTIONS
The Air Conditioner will not start	The air conditioner is unplugged or not connected well.	<ul style="list-style-type: none"> • Make sure the air conditioner plug is pushed completely into the outlet
	The fuse is blown/circuit breaker is tripped.	<ul style="list-style-type: none"> • Check the house fuse/circuit breaker box and replace the fuse or reset the breaker.
	Power Failure	<ul style="list-style-type: none"> • The unit will automatically re-start when power is restored. • There is a protective time delay (approx. 3 minutes) to prevent tripping of the compressor overload. For this reason, the unit may not start normal cooling for 3 minutes after it is turned back on.
	The current interrupter device is tripped.	<ul style="list-style-type: none"> • Press the RESET button located on the power cord plug. • If the RESET button will not stay engaged, discontinue use of the air conditioner and contact a qualified service technician.
The Air Conditioner does not cool as it should	Airflow is restricted	<ul style="list-style-type: none"> • Make sure there are no curtains, blinds, or furniture blocking the front of the air conditioner
	The temperature control may not be set correctly.	<ul style="list-style-type: none"> • Lower the set thermostat temperature
	The air filter is dirty	<ul style="list-style-type: none"> • Clean the filter. See the Cleaning and Care Section of the manual.
	The room may be too warm	<ul style="list-style-type: none"> • Please allow time for the room to cool down after turning on the air conditioner.
	Cold air is escaping	<ul style="list-style-type: none"> • Check for open furnace registers and cold air returns
	The Evaporator is frozen	<ul style="list-style-type: none"> • The unit is defrosting and will resume operation when done.
The Dehumidifier function is not providing cool air as it should	Is the TIMER ON enabled?	<ul style="list-style-type: none"> • Cancel the TIMER or wait until the unit turns on.
The Remote Control is not working	The batteries are inserted incorrectly	<ul style="list-style-type: none"> • Check the position of the batteries.
	The batteries may be dead	<ul style="list-style-type: none"> • Replace the batteries

TROUBLESHOOTING (CONT.)

PROBLEM	POSSIBLE CAUSES	SOLUTIONS
The LCD Display is showing "E5"	Low Voltage Protection	<ul style="list-style-type: none">• Unplug for 10 minutes and then turn on the unit. If "E5" is still displayed, contact customer service.
The LCD Display is showing "H8"	The backup water tank is full	<ul style="list-style-type: none">• Drain the water tank• If the "H8" is still displayed after the water tank has been emptied, contact customer service.
The LCD Display is showing "F1", "F2", or "F4"	Internal malfunction	<ul style="list-style-type: none">• Contact Customer Service

WARRANTY

One Year Limited Warranty

Soleus International Inc. warrants the accompanying Soleus Air Powered by Gree Portable Air Conditioner to be free of defects in material and workmanship for the applications specified in its operation instruction for a period of ONE (1) year from the date of original retail purchase in the United States.

If the unit exhibits a defect in normal use, Soleus International Inc. will, at its option, either repair or replace it, free of charge within a reasonable time after the unit is returned during the warranty period.

As a condition to any warranty service obligation, the consumer must present this Warranty Certificate along with a copy of the original purchase invoice.

THIS WARRANTY DOES NOT COVER:

- Damage, accidental or otherwise, to the unit while in the possession of a consumer not caused by a defect in material or workmanship.
- Damage caused by consumer misuse, tampering, or failure to follow the care and special handling provisions in the instructions.
- Damage to the finish of the case, or other appearance parts caused by wear.
- Damage caused by repairs or alterations of the unit by anyone other than those authorized by Soleus International Inc.
- Freight and Insurance cost for the warranty service.

ALL WARRANTIES, INCLUDING ANY IMPLIED WARRANTY OF MERCHANTABILITY ARE LIMITED TO ONE-YEAR DURATION OF THIS EXPRESS LIMITED WARRANTY. **SOLEUS INTERNATIONAL INC.** DISCLAIMS ANY LIABILITY FOR CONSEQUENTIAL OR INCIDENTAL DAMAGES AND IN NO EVENT SHALL SOLEUS INTERNATIONAL INC'S LIABILITY EXCEED THE RETAIL VALUE OF THE UNIT FOR BREACH OF ANY WRITTEN OR IMPLIED WARRANTY WITH RESPECT TO THIS UNIT.

This warranty covers only new products purchased from our authorized dealers or retailers. It does not cover used, salvaged, or refurbished products.

As some states do not allow the limitation or exclusion of incidental or consequential damages, or do not allow limitation on implied warranties, the above limitations and exclusions may not apply to you. This warranty gives you specific legal rights, and you may also have other rights that vary from state to state.

For Technical Support & Warranty Service

Please Call (888) 876-5387

Or Write To:

Soleus International Inc.

20035 E. Walnut Dr. North

City of Industry, CA 91789 U.S.A.

www.soleusair.com