

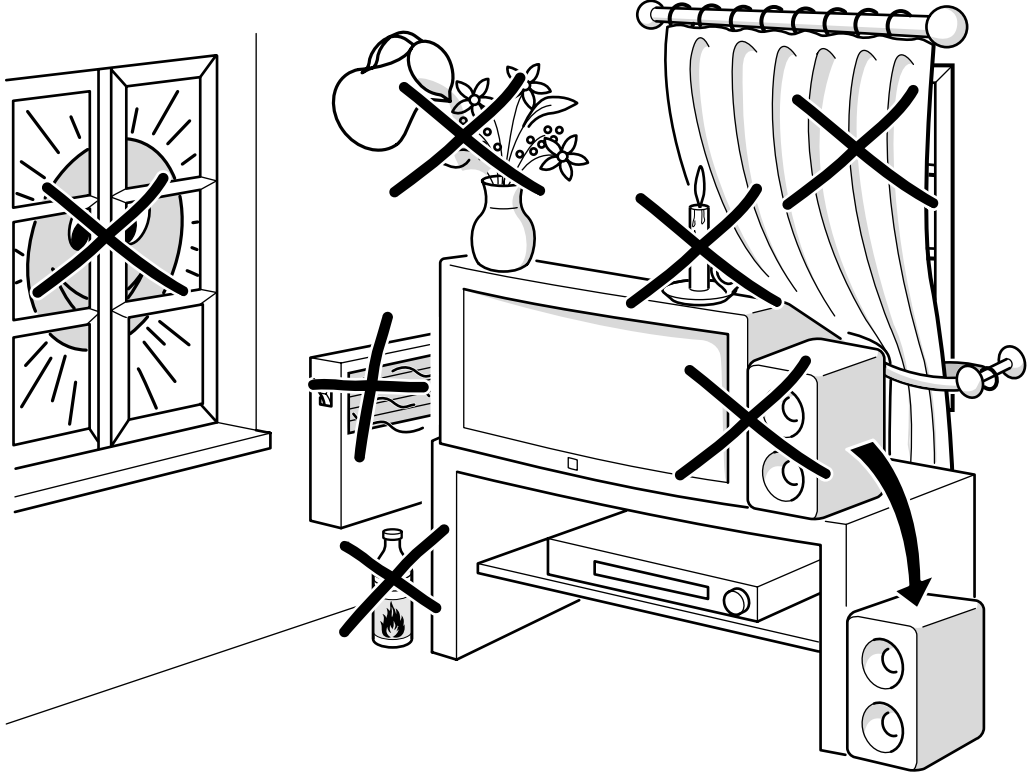

U s e r
m a n u a l
U s e r
m a n u a l
U s e r
m a n u a l
U s e r
m a n u a l
U s e r
m a n u a l
U s e r
m a n u a l

2 9 D L 2 5 U D
3 3 M S 2 5 U D

THOMSON

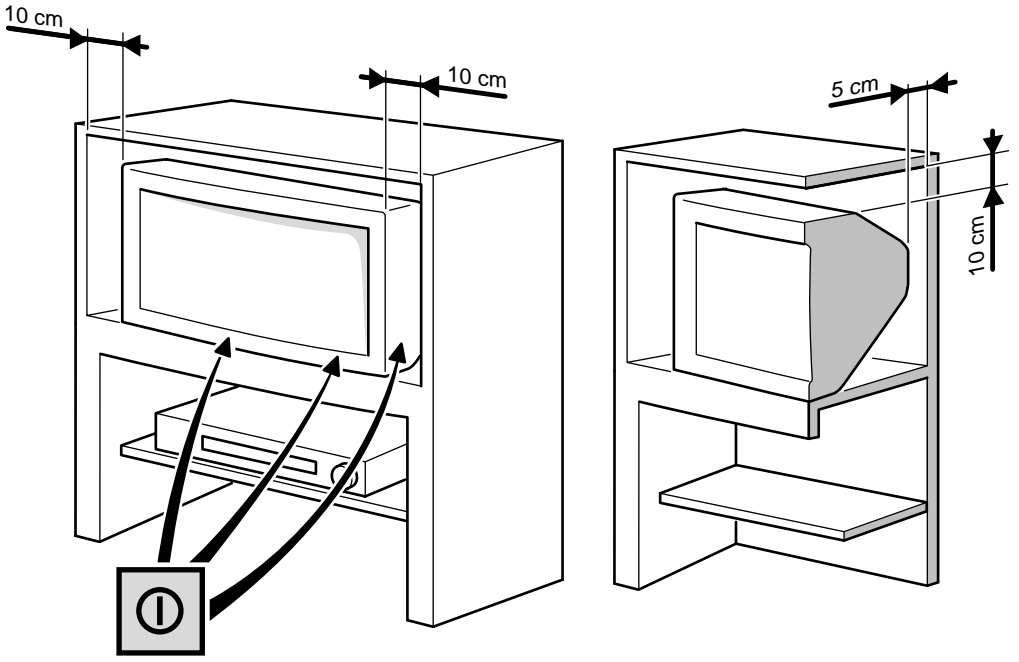

About this manual

This document is common to several television models. Therefore, certain functions or settings may not apply to the model you have purchased

About the switch

The position of the ON/OFF switch  differs depending on the model. It may be located on the front or on the right-hand side of your set (see the drawing inside the cover page of your manual).

About safety

To ensure your own safety and safe operation of the equipment, observe the following instructions thoroughly.

TV sets require sufficient ventilation to prevent their components from overheating, which will cause failure. Do not block the ventilation openings at the rear. If you place your TV set in a special piece of furniture, make sure there is enough space for unhindered air circulation. Do not place the TV set in the close vicinity of a heater.

The TV set has been designed for use in dry rooms. Should you use it, in exceptional circumstances in the open air (example: on the balcony, in the veranda or tent), you must absolutely protect it against moisture (dew, rain, splash water). Before switching on a cold TV set in a warm room, you should wait until any condensation in the screen has dried by itself.

Maximum ambient temperature: 35°C

Maximum humidity: 85%

By the end of your TV evening or when away from home for a longer period, we recommend that you turn off the TV set with the On/Off-switch.

The mains plug must be easily accessible.

In the following cases, we recommend that you pull out the mains connector:

1. During a thunderstorm. In such a case, it is advisable that you also disconnect the TV set from the aerial socket.
2. When odour or smoke emanates from the set.

Never attempt to open your TV set yourself.

Further information:

The TV set shielding is sufficient to prevent X-radiation to the exterior.

Any operation performed by a non skilled person, change of high voltage or replacement of the picture tube by a model not complying with the manufacturer specification are likely to cause considerable increase in X-radiation. A TV set modified in such a way no longer complies with the manufacturers' specification and must not be used.

About cleaning

The screen is to be cleaned with liquid glass cleaners.

- Never use abrasive products.
- Clean the cabinet with a soft cloth soaked with neutral cleaner. Do not use solvents, such as white spirit or alcohol-based cleaning products since they may damage your television.
- At regular intervals, clean the ventilation grids at the rear of the TV set.

About degaussing

The terrestrial magnetic field may have an influence on your TV set. This influence is revealed by the coloured spots, which appear on the screen.

Should this be the case:

- Turn the equipment off by means of the On/Off-switch.
- Wait about one hour before switching the set on again.

This procedure performs automatic degaussing of the screen. Should there still be coloured spots on the screen, repeat the operation.



The pages of this publication are printed on recycled paper.

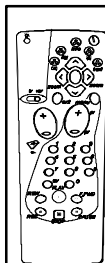

Using the remote control and fitting the batteries.

Page 5

How to call up a menu and how to select a function, a setting or an option.



Page 8

Installation

About this manual	1
About the switch	1
About safety	1
About cleaning	1
About degaussing	1
Basic connections	3
TV / VCR / Antenna connections	4
TV / Antenna	4
TV / VCR / Antenna	4
Remote control	5
Television Functions	5
Video Recorder Functions	6
Navigation principles	8
Calling up the INSTALLATION MAIN MENU	8
Calling up the SUMMARY	8
Calling up a Menu	8
Navigating within the Menus	8
Installing your television for the first time	9
Automatic installation	10
Programme organisation	11
Manual programming	12
Channel number guide	13
Channel number guide (Ireland)	14
Personal settings	15
Preferences	16

Instructions for Use

Daily viewing	17
Sound Settings	17
Picture Adjustment	19
List of Channels	19
Time	20
Selecting Programmes	21
Scrolling the Programmes	21
Audio-visual (AV) Programmes	21
Volume Control	21
Muting the Sound	21
Zoom (16/9 models only)	21
Displaying Information	21
Television Lock	21
Switching Off the Television	21
Teletext	22
Standard Functions	22
Other Connections	23
Other Possibilities	23
Speaker connection	23
Euro-AV socket connections	24

Basic connections

The mains plug (1) supplies power to the television. The television must only be plugged in to a 220-240 V - 50 Hz power supply. It must never be plugged in to a DC source. If the plug comes away from the lead, never attempt to plug it in: this could cause electrocution.

The aerial socket (2), located on the rear of the television, can be used to connect an external aerial or other appliance equipped with a modulator such as a VCR, satellite receiver, etc.

If you connect an appliance to the aerial jack, you must give it a channel number. To do this, switch on the appliance, then use the television to find the modulator channel (see the appliance manual). Now give it a programme number and memorise it (see Manual Programming of channels). Then, when you wish to use the appliance, simply select its programme number on the television. This procedure is not required for VCR's not equipped with a modulator.

The SCART socket AV1 (3), located on the rear of the television, is intended to connect a VCR or a camcorder (VHS, 8 mm), a Canal+ decoder, a video games console or RGB-signal emitting appliances.

The SCART socket AV2 (3), located on the rear of the television, is intended to connect a VCR or a camcorder (VHS, 8 mm, S-VHS or Hi-8).

We strongly recommend the use of this type of connection, which gives a better picture quality. To use the peripheral appliance that you have connected, press the AV key on your remote control (press once to select AV1; twice to select AV2; three times for AV3: see "Other Connections"). This selection is automatic for some appliances. Pressing "play" on a VCR, or switching on a satellite receiver connected to AV1 or AV2 will automatically switch on your television.

When you stop the VCR, if you have not changed channels while watching the VCR, the television automatically switches back to the channel you were watching beforehand. If the television has been switched on from the VCR, it switches to standby when the VCR is switched off. The television automatically switches to 16/9 format if the connected appliance delivers the corresponding signal.

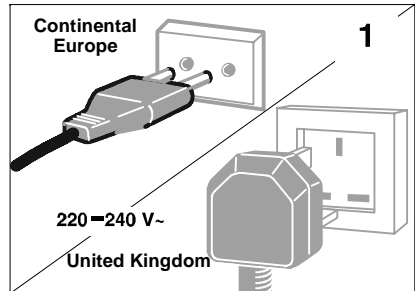

The plug is fitted with a fuse which protects your television. If your television does not work, the fuse may be blown. In this case, replace it with an identical 5 Amp ASTA or Ir BSI (BS 1362) certified fuse.

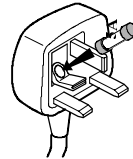

Note: the mains lead of your television is fitted with a moulded plug. This lead contains all the safety equipment, so you are advised when replacing it not to use a non-specific commercially-available model.

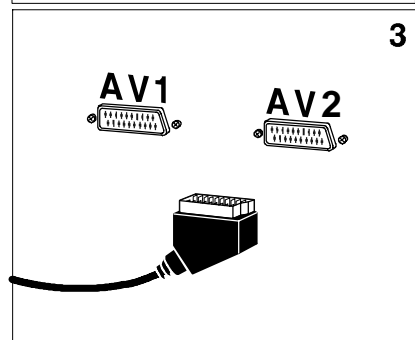
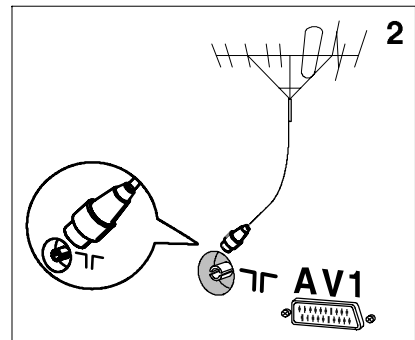

TV / VCR / Antenna connections

In order to avoid any interference, use the male to male adaptor and the male to female cable supplied with your TV set as shown below:

TV / Antenna

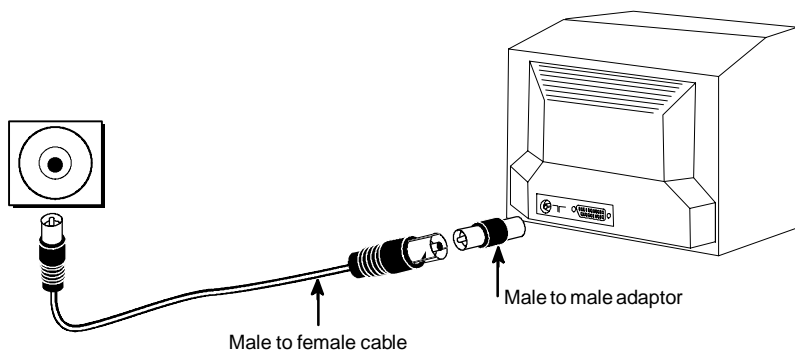

TV / VCR / Antenna

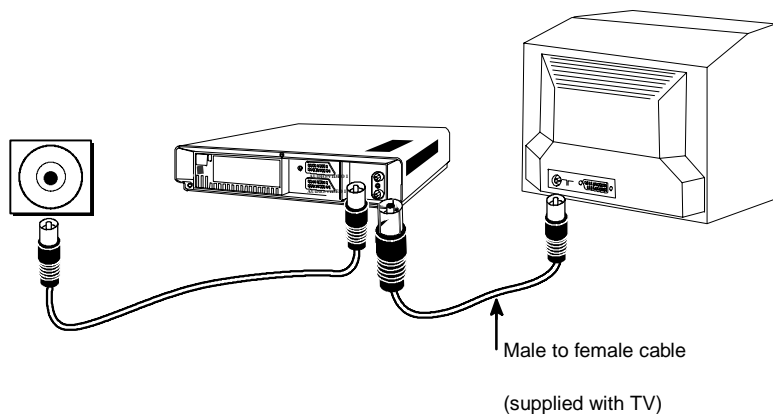

Remote control

Television Functions tv vcr



Display of channel, time, sound (yellow button) (and zoom for models with zoom)

This key is active only when using the Teletext (blue key)

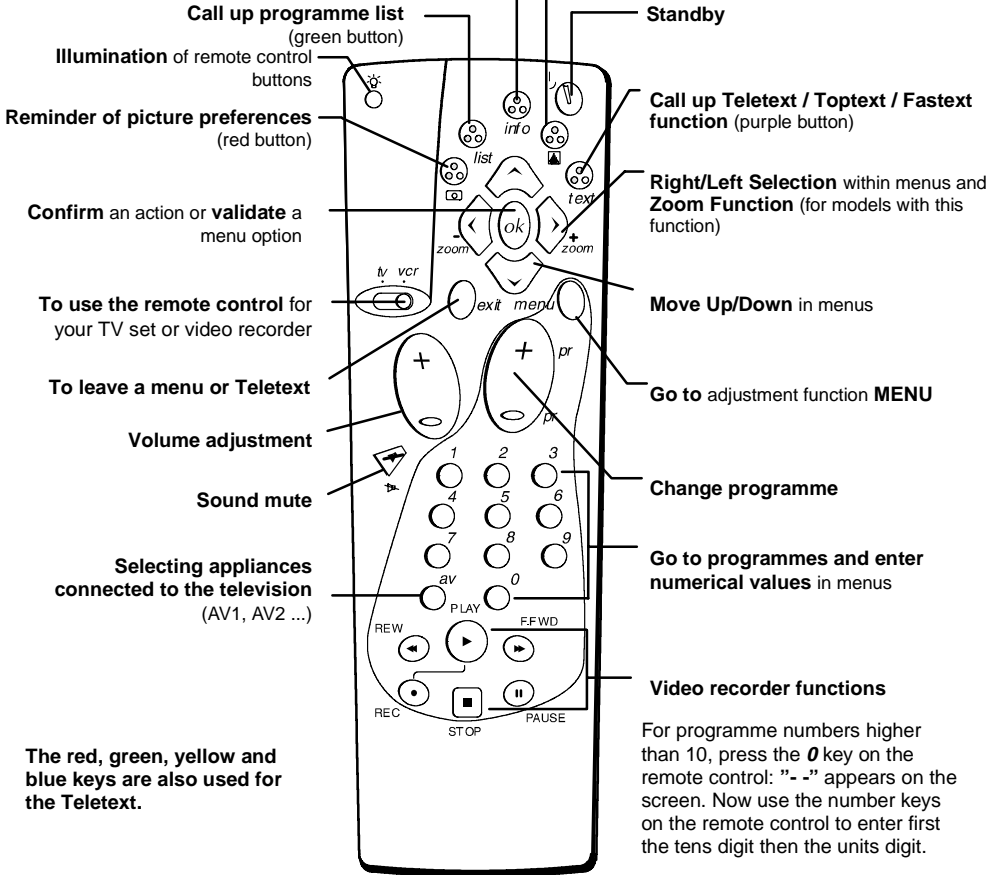

The red, green, yellow and blue keys are also used for the Teletext.

For programme numbers higher than 10, press the 0 key on the remote control: "- -" appears on the screen. Now use the number keys on the remote control to enter first the tens digit then the units digit.

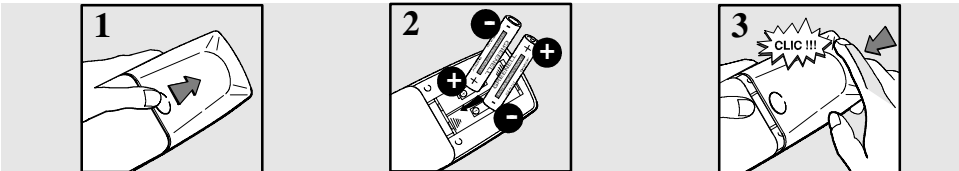

Please respect the environment! Before throwing any batteries away, consult your distributor who may be able to take them back for specific recycling.

Remote control

Video Recorder Functions

You can use your remote control for some functions on most brands of video recorders. Before using it, you must enter the code of your video recorder in the table on the next page, following the adjustment procedure described below.



You may find that this remote control is not compatible with your brand of video recorder or that some functions are not available.

Entering your code

Using the Video Recorder

1. Set the remote control to VCR.
2. While holding down the **menu** button enter a 3-digit code corresponding to the brand of your video recorder.
3. Release the **menu** button
4. Switch off your video recorder by pressing the **1** button
5. If the VCR does not switch off, try one of the other codes corresponding to your video recorder.



When you change the batteries, you will have to enter the maker's code again

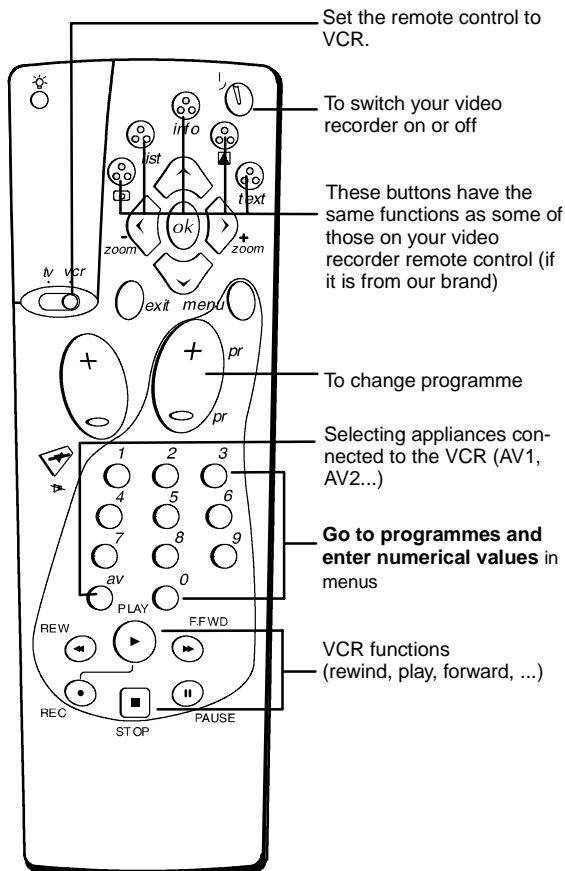

Remote control

YOUR BRAND OF VIDEO RECORDER	MANUFACTURER'S CODE
AIWA	067 - 068
AKAI	003 - 004 - 005 - 006 - 007 - 008
BLAUPUNKT	008 - 009 - 062
BRANDT	001 - 012 - 002 - 059 - 010
DAEWOO	040 - 041 - 042 - 043 - 044 - 045 - 046 - 047
FERGUSON	001 - 002 - 060 - 012 - 053 - 055 - 057 - 059 - 010
FISHER	035 - 036 - 037
FUNAI	030
GOLDSTAR	023 - 034
GRUNDIG	061 - 069 - 070
HITACHI	010 - 012 - 022 - 023
JVC	006 - 010 - 011 - 012 - 013
MINIBITS	048 - 049
NEC	039
NOKIA	003 - 010 - 035 - 038
NORDMENDE	001 - 002 - 012 - 054 - 057 - 058 - 059 - 010
ORION	024 - 025 - 026 - 027 - 028 - 029
PANASONIC	008 - 009 - 062
PHILIPS	061 - 062 - 063 - 064 - 065 - 066
RADIOLA	061 - 062 - 063 - 064 - 065 - 066
SABA	001 - 002 - 012 - 053 - 055 - 057 - 058 - 059 - 010
SAMSUNG	033
SANYO	019 - 020 - 021
SCHNEIDER	061 - 062 - 063 - 064 - 065 - 066
SHARP	031 - 032
SONY	015 - 016 - 017 - 018
TELEAVIA	001 - 012 - 059 - 010
TELEFUNKEN	001 - 002 - 012 - 055 - 059 - 010
THOMSON	001 - 002 - 012 - 054 - 057 - 058 - 059 - 010
TOSHIBA	010 - 011 - 014



If you cannot see the brand of your video recorder on this list, try the codes of the other brands.

Navigation principles

Calling up the INSTALLATION MAIN MENU

If there is no menu displayed on the screen, press and hold the **menu** key on the remote control. The settings **SUMMARY** is displayed first, followed by the **INSTALLATION MAIN MENU** which you can use to operate your television.

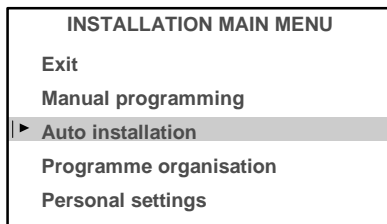

Calling up the SUMMARY

Press and release the **menu** key on the remote control to display the list of menus available for using your television functions or adjusting your television



Calling up a Menu

Select the menu you wish using the **Up/Down** keys. Press the **OK** key to validate..

Navigating within the Menus

Use the **Up/Down** keys ① to select a line.

Use the **Left/Right** keys ② to:

- Increase or decrease a value:

for example:

Fine tuning ◀|▶ 

- Select an option:

for example: Reception ◀|▶ Aerial

Reception ◀|▶ Cable

- Activate or deactivate an option:

for example: Decoder ⇌

- Access a sub-menu:

for example: Picture preferences|▶

You can use the **OK** ③ key to:

- Activate or deactivate an option:

for example: Decoder ⇌

- Access a sub-menu:

for example: Picture preferences|▶

- Validate an action:

for example: Store on PR number

Use the **exit** ④ key to exit a menu.

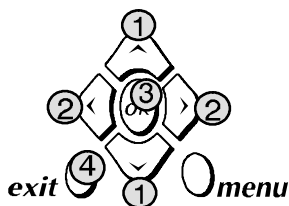
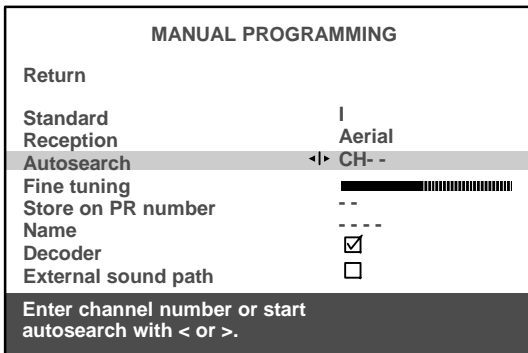

Installing your television for the first time

First plug the television into a mains power outlet and to the external aerial or a cable network, then switch on using the ON/OFF switch ① located on the front or the side of your set.

When you switch on your television for the first time, the language selection menu* is displayed (Fig. 1). If this does not happen, set the television to standby then press and hold the **pr** – key on the television until this menu appears.

Installation Instructions (start)

1. Use the **Up/Down** keys to select the language in which you wish the menus to be displayed.
2. Then validate using **ok**.
3. A list of countries* is now displayed (Fig. 2). Select the country in which you live, or the country from which you wish to receive the broadcasts if you live in a border area.
4. Then validate using **ok**.
5. A welcome message is displayed.
6. Run the automatic installation sequence using **ok**.
7. A message appears to inform you that automatic installation has started (Fig. 3). Wait for a few minutes. A new message will inform you when automatic installation is completed.
8. If you wish to check or modify the channel organisation, press **ok** and see the **Programme organisation** chapter.

If you do not wish to modify the channel organisation, you can exit the menu by pressing **exit** then watch the channel of your choice. Choose the desired channel using the number keys (1, 2, 3, ...) and the **pr + / pr –** keys.

If you have a decoder, see the **Manual programming** chapter.

*Your television will only search for channels corresponding to the country you have selected. See the **Manual channel programming** chapter to install any channels not found.*

*For cable networks, read the **Automatic channel installation** chapter to install any channels not found.*

*The list of languages and countries may vary from one model to another.

Installation Instructions (end)

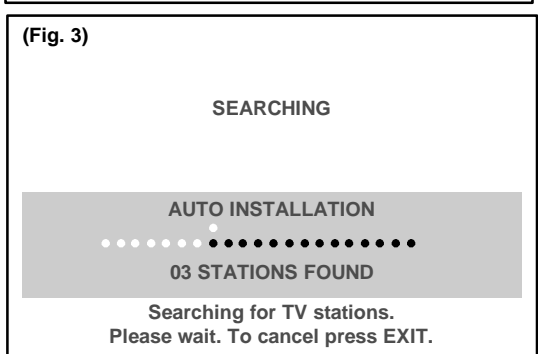
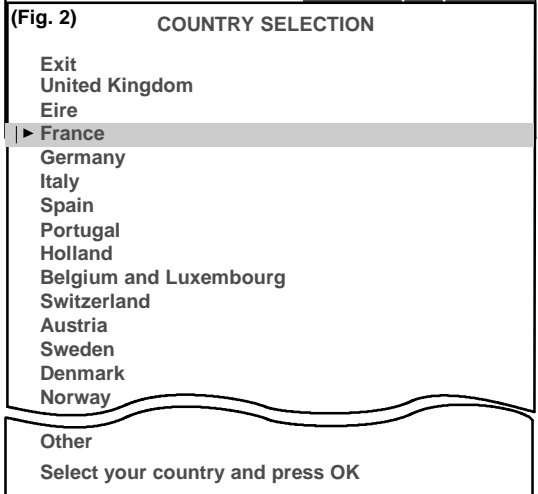
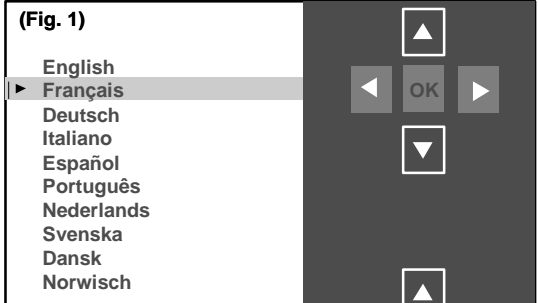

Automatic installation

The **Automatic installation** function is useful if you have to go through the installation procedure again, such as when moving house. This function deletes all previously memorised programmes. To install a new channel, you should use the **Manual programming** function.

Before running **AUTO INSTALLATION**, check the **PERSONAL SETTINGS** menu to ensure that the country displayed is correct.



Your television will only search for channels corresponding to the selected country, so see the **Manual programming** chapter to install any channels not found. For cable networks, if you have not found certain channels, select **Other** instead of a country name in the **PERSONAL SETTINGS** menu, then run automatic installation again.

1. Press and hold the **menu** key on the remote control to display the **INSTALLATION MAIN MENU** (The **SUMMARY** appears first, followed by the **INSTALLATION MAIN MENU**).
2. Select the **Auto installation** line.
3. Validate using **ok**.

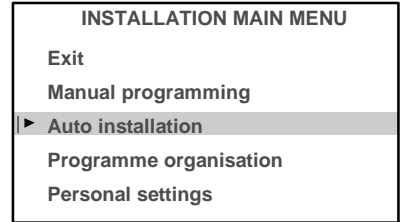

A message will inform you that **Automatic installation** has begun.
Wait for a few minutes.
A new message will inform you when **Automatic installation** is completed.

If you wish to check or reorganize your channel display, press the **ok** key and see the **Programme organisation** chapter.

If you do not wish to **reorganize your programmes**, you can exit this menu by pressing **exit**, then watch the programme of your choice. Choose the desired programme using the number keys (1, 2, 3, ...) and the **pr + / pr -** keys.



Programme organisation

During automatic installation, your television will search for the channel name and assign it a programme number according to the selected country. You can use the **PROGRAMME ORGANISATION** menu to name any channel name not found, to change the order in which the channels are displayed, or to delete channels for which reception is too poor. Follow the messages at the bottom of the screen. For further details, read the information below.



*If you wish to access the **PROGRAMME ORGANISATION**, menu thereafter, first press and hold the **menu** key on the remote control to display the **INSTALLATION MAIN MENU** (the **SUMMARY** is displayed first, followed by the **INSTALLATION MAIN MENU**) then select Programme organisation and validate using **ok**.*

INSTALLATION MAIN MENU

- Exit
- Manual programming
- Auto installation
- ▶ Programme organisation
- Personal settings

- To delete a programme for which reception is too poor:

1. Select the line marked **Select program**.
2. Use the **pr + / pr -** or **Left/Right** keys to list your channels.
3. When you get to a channel you wish to delete, select the line marked **Delete program**.
4. Press **ok** to delete the programme.
5. Validate using **ok**.

- To organize your channels to suit you:

1. Select the line marked **Select program**.
2. Use the **pr + / pr -** or **Left/Right** keys and the programmes logos to find the programme to which you wish to give the No.1. Its present number appears on the line marked **Select program**.
3. Select the line marked **Swap with PR**.
4. Enter **01**.
5. Press **ok**. The two programmes swap position and the desired programme becomes N°1.
6. Repeat the above procedure for the other channels.

- To name your channels:

1. Select the line marked **Change pr. name**
2. Select the character you wish to modify using the **Left/Right** keys.
3. Use the **1** and **2** keys to display the letter you require.
The name you have entered will be memorised when you move to another line or exit the menu.



If you wish to change the order in which your programmes are displayed or if you wish to name other programmes, repeat the procedures described above.

When you have finished organizing the programmes, exit the menu using **exit**.

PROGRAMME ORGANISATION		10	MTV
Return		11	FR2
		12	TF1
		13	EURO
		14	CH40
Select program.	◀▶ 13	15	CC01
Swap with PR.	--	16	ARTE
Change pr. name	EURO	17	CART
Delete program.	13	18	----
		19	ARD
Select programme number using PR-/PR+ or </> or 0 to 9 keys.			

Select the line marked **Return** to return to the previous menu.

Manual programming

The manual installation function is useful if some programmes have not been installed even after AUTOMATIC INSTALLATION.

1. Press and hold **menu**, the **SUMMARY** is displayed first, followed by the **INSTALLATION MAIN MENU**.
2. Select the line marked **Manual programming**.
3. Display the menu using **ok**.
4. Now continue by following the messages at the bottom of the screen. For further details, read the information below.

Standard :

Select the standard using **Left/Right** keys that corresponds to your country from the list of standards.

The number of standards proposed will differ from one model to another.

France	for France and Luxemburg
DKK'	eg. for Eastern Europe and the Middle-East
I	for the United Kingdom and Ireland
Euro BG	for Western Europe

Reception :

Your television can pick up channels either via an aerial (RF channels) or via a cable network. Certain cable networks use the same frequencies as the RF channels. If this is the case, you must select **Aerial** instead of **Cable**.

Autosearch :

Enter the programme number if you know it. If not, search using the **Left/Right** keys. Your television will stop at the first channel it tunes into. If you wish to memorize it, go to the line marked **Store on PR number**. If not, resume the search using the **Left/Right** keys.

Fine tuning :

You can use this to improve the picture if the transmitter frequency is out of adjustment. Use the **Left/Right** keys to obtain the best possible picture and sound.

Store on PR number :

Enter the programme number you wish to give the channel (e.g.: 01 for BBC1). Memorise using **ok**.

Name :

If the station has been identified by the transmitter, its name will be inscribed automatically. You can change the proposed name or enter it if it has not already been identified. Select the character you wish to modify using the **Left/Right** keys. Use the **1** or **2** keys to display the character you desire.

Decoder :

Use the **Left/Right** keys to tick the box if the channel is coded and if a decoder is connected to the AV1 jack.

External sound path :

Switch on your decoder. If the sound is coded or if you have no sound, activate or deactivate the box as required using the **Left/Right** keys.



*Once you have made all the adjustments you wish to a programme, go to **Store on PR number** and press **ok** to memorise these. Then move on to the next channel.*

Once you have completed your Manual Programming, exit the menu using **exit**.

INSTALLATION MAIN MENU	
Exit	
▶ Manual programming	
Auto installation	
Programme organisation	
Personal settings	

MANUAL PROGRAMMING	
Return	
Standard	I
Reception	Aerial
Autosearch	◀▶ CH - -
Fine tuning	██
Store on PR number	--
Name	---
Decoder	<input checked="" type="checkbox"/>
External sound path	<input type="checkbox"/>
Enter channel number or start autosearch with < or >.	

Select the line marked **Return** to return to the previous menu.

Manual Programming

Channel number guide

Only the main transmitters are listed. There are in addition many relay stations, and full lists are available from the Broadcasting Authorities.

0	BBC 1	BBC 2	ITV	CH4
London & South-East				
Bluebell Hill	40	46	43▼	65▼
Crystal Palace	26▼	33▼	23▼	30▼
Dover	50	56	66▼	53▼
Heathfield	49	52	64▼	67▼
Oxford	57▼	63▼	60▼	53▼
South-West				
Beacon Hill	57	63	60▼	53▼
Caradon Hill	22▼	28▼	25▼	32▼
Huntshaw Cross	55	62	59▼	65▼
Redruth	51	44	41▼	47▼
Stockland Hill	33	26	23▼	29▼
Channel Islands				
Fremont Point	51	44	41▼	47▼
South				
Hannington	39▼	45▼	42▼	66▼
Midhurst	61	55	58▼	68▼
Rowridge	31▼	24▼	27▼	21▼
West				
Mendip	58▼	64▼	61▼	54▼
East				
Sandy Heath	31▼	27▼	24▼	21▼
Sudbury	51▼	44▼	41▼	47▼
Tacolneston	62▼	55▼	59▼	65▼
Midlands				
Ridge Hill	22	28	25▼	32▼
Sutton Coldfield	46▼	40▼	43▼	50▼
The Wrekin	26	33	23▼	29▼
Waltham	58▼	64▼	61▼	54▼
North				
Belmont	22▼	28▼	25▼	32▼
Emley Moor	44▼	51▼	47▼	41▼
North-West				
Caldbeck	30▼	34▼	28▼	32▼
Winter Hill	55▼	62▼	59▼	65▼
North-East				
Bilsdale West Moor	33▼	26▼	29▼	23▼
Chatton	39	45	49▼	42▼
Pontop Pike	58▼	64▼	61▼	54▼
Scotland				
Angus	57	63	60▼	53▼
Black Hill	40▼	46▼	43▼	50▼
Sandale	22	-	-	-
Caldbeck	-	34	28▼	32▼
Craigkelly	31▼	27▼	24▼	21▼
Darvel	33	26	23▼	29
Durris	22▼	28▼	25▼	32▼
Eitshal	33	26	23	29
Keelylang Hill	40	46	43	50
Knock More	33	26	23▼	29▼
Rosemarkie	39	45	49▼	42▼
Rumster Forest	31	27	24▼	21▼
Selkirk	55	62	59▼	65▼

Wales

	BBC 1	BBC 2	ITV	CH4
Blaenplwyf	31▼	27▼	24	21
Carmel	57	63	60▼	53▼
Llanddona	57▼	63▼	60▼	53▼
Moel-y-Parc	52	45	49▼	42▼
Presely	46	40	43▼	50▼
Wenvoe	44▼	51▼	41▼	47▼

Northern Ireland

	BBC 1	BBC 2	ITV	CH4
Brougher Mountain	22	28	25▼	32▼
Divis	31▼	27▼	24▼	21▼
Limavady	55	62	59▼	65▼

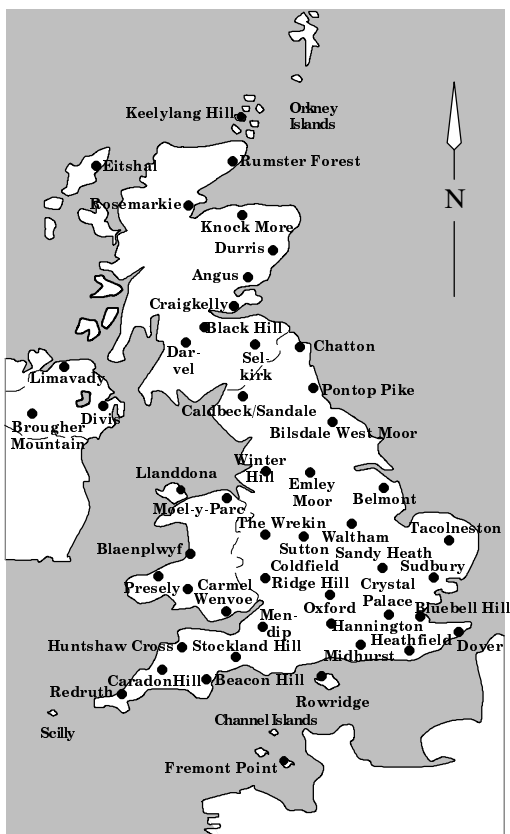

▼ Already transmitting NICAM

Manual Programming

Channel number guide (Ireland)

In addition to the RTE main transmitters listed, there are many RTE transposers throughout the country. If your area is not covered by a main transmitter and you are not sure of the channel numbers of your local transmissions, your television dealer is the best person to advise you. He will also know whether you need a horizontal or vertical aerial to suit the transmissions.

REPUBLIC OF IRELAND	RTE 1	RTE 2	NORTHERN IRELAND	BBC 1	BBC 2	UTV	CH4
North-West							
Holywell Hill	23	26	Brougher Mountain	22	28	25	32
Truskmore	09 (1)	07 (G)	Divis	31	27	24	21
North-East			Limavady	55	62	59	65
Clermont Carn	52	56					
East							
Kippure	08 (H)	10 (J)					
Dublin & East			WALES	BBC 1	BBC 2	HTV	S4C
Three Rock	29	33		WALES			
West			Presely	46	40	43	50
Maghera	02 (B)	08 (H)					
Central							
Cairn Hill	40	43					
South-West							
Mullaghanish	04 (D)	07 (G)					
South East							
Mount Leinster	06 (F)	09 (I)					

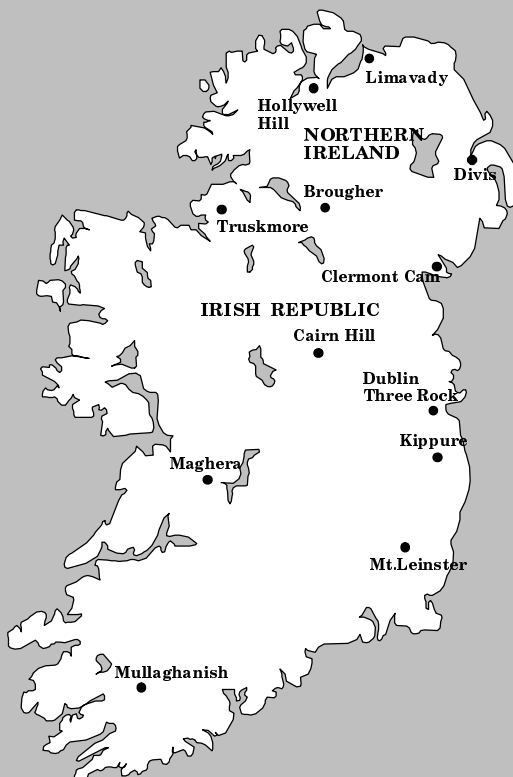

Personal settings

1. Press and hold the **menu** key: the **SUMMARY** is displayed first, followed by the **INSTALLATION MAIN MENU**.
2. Select the line marked **Personal settings**.
3. Display the menu using **ok**.
4. Continue by following the messages at the bottom of the screen.

For further details, read the information below.

Menu language :

Select the language in which the menus are to be displayed.

Country :

Indicate the country in which you are if you wish to rerun **Automatic Programming**.

*For cable networks, if certain channels have not been found, select **Other** instead of the country name before running automatic installation again.*

You may find that the characters of certain teletext languages are inaccessible for the selected country.



Auto volume level :

This is a **sound control** function which aims to equalise the volume level between different channels, and between different programmes on the same channel.

Activate or deactivate the auto volume level as required.



*On models equipped with **Dolby Surround**, this function remains inactive if **Dolby Virtual** or **Pro Logic** has been selected in the **SOUND** menu (see **Volume Control**).*

AV1, AV2, AV3 name :

Use these to give a name to each of your audio-visual programmes. Select the character you wish to modify using the **Left/Right** keys. Use the **1** or **2** keys to display the desired character.

Prog. to be used for reference time :

To display the time using the **info** key or to use the alarm function, the television clock must be set to the correct time. Select the line marked **Prog. to be used for reference time** and select a channel which broadcasts teletext. The time is set automatically and is displayed after the channel number.

Exit the menu using **exit**.

INSTALLATION MAIN MENU

Exit
Manual programming
Auto installation
Programme organisation
▶ Personal settings

PERSONAL SETTINGS

Return

Menu language English

Country UK

Auto volume level

AV1 name VCR

AV2 name - - - -

AV3 name CAMC

Prog. to be used for reference time <|▶ 06 13:15

Select a station from which you want to get the reference time.

Select the line marked **Return** to return to the previous menu.

Preferences

1. Display the **SUMMARY** by pressing and releasing the **menu** key on the remote control .
2. Select the line marked **Preferences**.
3. Display the menu using **Ok** .

 *Make your choice from the proposed options. Use the information below to help you.*

Show program. number :

If you wish to permanently display the number of the programme you are watching, tick the box using the **Left/Right** keys. Press the **Left/Right** keys again to deactivate this function.

AV2 video input :

Use the **Left/Right** keys to select the type of video signal received at the AV2 SCART socket (Video or S-Video).

AV3 video input :

Use the **Left/Right** keys to select the type of video signal received at the AV3 sockets (these sockets are located on the front or the side of the television).

Format control :

Use the **Left/Right** keys to select the desired picture format:

Auto : if the transmitter (for 16/9 format TV's) or the appliance connected to one of the peripheral jacks delivers the switching signal, the television automatically adapts to the transmitted picture format.

16/9 : manually selects widescreen picture format.

4/3 : manually selects this picture format.

 *If you have selected 16/9 or 4/3, the television will switch back to Auto when you change channels or you switch off.*

Picture preferences :

To access the **PICTURE PREFERENCES** menu, press **Ok** .

 *If you wish, you can personalize certain picture settings. Select and set the proposed options. Use the information below to help you.*

Settings :

Select **Standard** or **Personal**.

Standard corresponds to the factory settings.



Personal corresponds to the settings that you have entered yourself.

 *The lines **Brightness**, **Colour** and **Contrast** are displayed only if you have selected **Personal** on the **Settings** line.*

Select each line one after the other and enter your required settings. You can recall these picture settings by pressing the red key on the remote control.

Exit the menu using **exit**.

PREFERENCES	
Return	
Show program. number	< > <input checked="" type="checkbox"/>
AV2 video input	Video
AV3 video input	S-Video
Format control	Auto
Picture preferences	

PICTURE PREFERENCES	
Return	
Settings	< > Personal
Brightness	
Colour	
Contrast	

Select the line marked **Return** to return to the previous menu.

Sound Settings

The television set fitted with a Dolby Pro Logic decoder lets you create a cinema studio sound quality in your own home with a coded Dolby Surround signal or you can enjoy special sound effects (with a stereo or mono signal) by connecting 2 pairs of loudspeakers (on some models), one pair of speakers or simply using the sound facilities of the television set.

Turn on the main switch and connect the speakers to the appropriate sockets. The black terminals of the speakers must be connected to the black terminals of the television set (likewise for the red terminals) (see **Speaker Connection**, page 23).

Display the **SUMMARY** using the **menu** key on the remote control. Select the line marked **Sound**. Validate using **OK**. The **SOUND** menu is displayed.

 *Select and set the proposed options. Use the information below to help you.*

Sound settings :

Use this menu to set the sound effect of your television.

To display the **SOUND SETTINGS** menu, select the line and press **OK**.

According to your set-up, activate:

- the external bass box (**Ext. subwoofer** line).
- the external line* (**Ext. amplifier** line).
- the rear speakers (**Surround** line).

Test balance

Activate this function, then set the following to the same sound level (according to your set-up):

- the balance between the left and right channels (**Balance L/R** line)
- the volume of the central channel (**Centre volume** line)
- the volume of the rear speakers (**Surround volume** line)

Return

To return to the **SOUND** menu

*Ext. amplifier

You can use external amplifiers instead of the television **configuration** (see **Speaker Connection**, page 23):

Amplifier with a Dolby Pro Logic decoder:

- Connect the left (**L**) and right (**R**) CINCH plugs from the television set to your amplifier.
- If there are rear speakers (Surround) disconnect them from the television set.
- Select **Normal** mode from the **SOUND** menu.
- Set the sound using the amplifier.

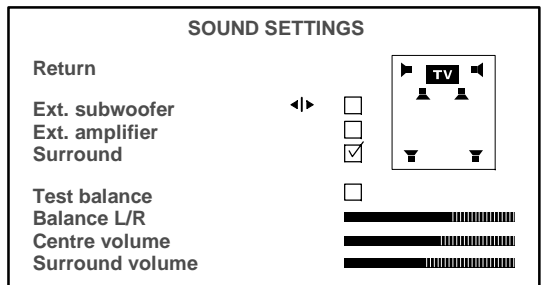
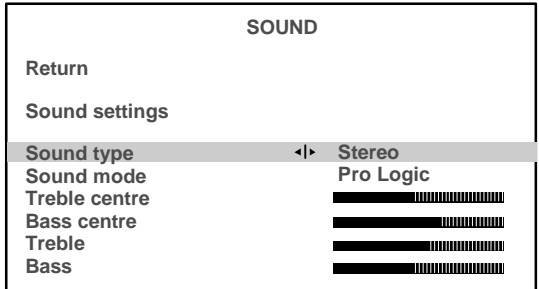

Daily viewing

Stereo amplifier:

- Connect the left (L) and right (R) CINCH plugs from the television set to your amplifier.
- Connect the rear speakers (Surround) to the television set.
- Activate the **Surround** line in the **SOUND SETTINGS** menu.
- Set the sound of the Left and Right channels using the amplifier and the sound of the Center and Rear channels (Surround) using the television set (**SOUND SETTINGS** menu).

In both cases, activate the **Ext. amplifier** function to cut the Left, Right and Center channels of the television set (if you have also activated the **Surround** option, the central channel is not cut).



Note: If you do not connect an external amplifier, cancel this option. Otherwise you will have no sound.

Sound type (1):



The choices available to you depend on the broadcast.

Select this line, then select the type of sound you desire.

Sound mode (2):

The choices available to you depend on the type of sound you previously selected.

The **Magic** and **Dolby Virtual** modes are only available in stereo if the **Surround** line has not been activated in the **SOUND SETTINGS** menu.

Select this line, then choose the desired mode using the **Left/Right** keys.

Treble centre, Bass centre



These lines appear according to the Sound mode selected.

Select each of the lines and set the bass and treble of the central channel.

Surround effect :



This line appears only if you have selected Dolby Virtual on the Sound mode line.

Select this line and adjust the surround effect to suit you.

Treble, Bass :

Select each of these lines and adjust to suit you.

Exit the menu using **exit**.

SOUND	
Return	
Sound type	◀▶ Automatic
Sound mode	Normal
Balance L/R	██
Treble	██
Bass	██
Surround effect	██

(1)

Broadcast

mono
stereo
dual
NICAM-3
AV

Choice

automatic - mono
mono - stereo
sound 1 - sound 2
sound 1 - sound 2 - sound 3
stereo - sound 1 - sound 2

(2)

Mode

Normal :

reproduces the original sound (mono or stereo).

Wide :
Magic :

gives a stereo effect on mono sounds.
accentuates the stereo effects and adds echo.

Dolby Virtual :

Hall :

Virtual Dolby Surround.
Reverberation effect
(with rear speakers.)

Pro Logic :

Cinema sound if the sound is coded in Dolby Surround (with rear speakers.)

Virtual Dolby Surround is based on Dolby Pro Logic decoding for the reproduction of the Left, Right, Centre and Virtual Surround sound channels using two loudspeakers.

""Dolby", ""Pro Logic" and the double -D symbol are trademarks of the Dolby Laboratories Licensing Corporation.

Manufactured under licence from Dolby Laboratories Licensing Corporation.

Daily viewing

Picture Adjustment

Display the **SUMMARY** using the **menu** key on the remote control. Select **Picture**. Validate using **ok**. The **PICTURE** menu is displayed.



Select and set the proposed options. Use the information below to help you.

Brightness, Colour, Contrast, Sharpness:

Select each of these lines one after the other and set as required.

Contrast expand :

Select this line then choose the desired Contrast expand setting (High or Low).

Tone :

Select this line then choose the desired colour tone (Warm, Neutral or Cold).

Exit the menu using **exit**.

PICTURE	
Return	
Brightness	< >
Colour	
Contrast	
Sharpness	
Contrast expand	
Tone	Neutral Cold

Select the line marked **Return** to return to the previous menu.

List of Channels



This list contains up to 10 pages. The number of pages depends on the number of programmes memorized. For each programme, the list indicates the station name or type and the programme number. The 3 AV programmes are listed on page 11.

To display the list, press the **list** key on the remote control

or

Display the **SUMMARY** using the **menu** key on the remote control. Select the line marked **List**. Validate using **ok**.

The page displayed is the page containing the programme you are watching. It is identified in the list by the symbol **TV**.

To display the next page, press the **Right** key.

To display the previous page, press the **Left** key.

If you wish to watch one of the programmes on the page displayed: Enter the last digit of the programme number (e.g. for 25 simply enter 5) on the remote control. The list disappears and your programme is selected.

Or,

- Select the programme using the **Up/Down** keys.
- Validate using **ok**.
- Exit the menu using **exit**.

LIST	
Exit	
▶ 01 BBC 1	
02 BBC 2	
03 FR 3	
04 CC19	
05 ARTE	TV
06 M6	
07 CNN	
08 PREM	
09 EURO	
Page +/- < >	
Programme: 0 - 9	

Daily viewing

Time



You can use this menu to switch your television on or off automatically at a set time.

Display the **SUMMARY** using the **menu** key on the remote control. Select the line marked **Time**. Validate using **ok**. The **TIME** menu is displayed.

Sleep timer :

Use the **Left/Right** keys to choose how long you wish to view before the television switches off. The television will switch off automatically at the end of this period. To cancel, set to **00:00**.

One minute before switching off, a message will inform you that the television is about to go off. If you wish to keep it on, press any key on the remote control or the local keyboard.

The television switches to Child lock mode after an automatic stop. It can only be switched on again from the remote control.

Current time :

The current time is given by the Teletext (see **PERSONAL SETTINGS** menu). You can also set the time manually using the number keys (0 to 9) on your remote control.

Wake-up timer :



If you wish to be woken up by your television on the channel of your choice, you must first set the television clock to the correct time (see above).

Use the **Left/Right** keys to tick the box and display the **Wake-up timer** menu.



The lines **Wake-up time**, **Programme number** and **Daily** only appear if you have ticked the box on the line marked **Wake-up timer**.

Wake-up time :

Use the number keys (0 to 9) on the remote control to set the time at which you wish to be woken.

Programme number :

Select the programme you wish to be woken by.

Daily :

Tick this box if you wish to be awakened at this time every day.

Exit the menu using **exit**.

Set the television to standby using the  key on the remote control. The red indicator light on the television flashes.

The television will come on automatically at the programmed time and will go off one hour later if you do not use the remote control.

	TIME
Return	
Sleep timer	< > 00 : 00
Current time	11 : 28
Wake-up timer	<input checked="" type="checkbox"/>
Wake-up time	07 : 07
Programme number	01 BBC1
Daily	<input type="checkbox"/>

Select the line marked **Return** to return to the previous menu.

Selecting Programmes

For channels 1 to 9, press the number key corresponding to the desired channel on the remote control. For programme numbers higher than 10, press the **0** key on the remote control: "-.-" appears on the screen. Now use the number keys on the remote control to enter first the tens digit then the units digit.



*If you press **0** while "-.-" is already displayed, the display returns to **0-**, in which case you can only select programmes 1 to 9.*

Scrolling the Programmes

You can scroll through the programmes using the **pr + / pr -** keys.

Audio-visual (AV) Programmes

Press the **av** key to call the last audio-visual (AV) programme watched. Press repeatedly to scroll the audio-visual (AV) programmes on the screen.

Volume Control

Use the volume +/- keys to increase or decrease the volume.

Muting the Sound

Press the  key to mute the sound. Press again to restore the sound.

Zoom

(16/9 models only)

This function is useful for 4/3 or letterbox pictures (black bands at the top and bottom of the screen).

Use the **Left/Right** keys to select the desired zoom position:

ZOOM 0: 4/3 picture (black bands at the sides).

FULL SCREEN: for a 4/3 picture that fills the screen.

ZOOM 1: for letterbox pictures.

Displaying Information

Press the **info** key to display the following information on the screen: channel number and name, time, zoom, type of sound.

Television Lock



You can use this function to prevent anyone from switching on the television using the buttons on the television set.

The buttons on the television set are locked in the following cases:

- If you switch off the set by pressing and holding the  key on the remote control for more than 3 seconds,
- After a programmed stop,
- If the television is set to standby when the alarm has been set.

When the television is locked the red power will be light flashing. The television can now only be operated from the remote control. To release the lock, press any number key on the remote control.

Switching Off the Television

To switch off the television, press the Standby key on the remote control or press the ON/OFF switch on the television set.

Teletext



Certain channels broadcast an electronic news page service with a range of different information services. The presentation and use of the Teletext differ from one country to another and from one programme to another (Teletext, Fasttext or Toptext).

Press the **text** key to display the **Teletext Index** (page 100).

A message will inform you if the programme you are watching has no Teletext service.

To call up a page:

Enter the 3 digits of the page number you wish to consult (for example, 150 or 170).

After a moment, the page appears.

Use the **Left/Right** keys to consult the next or the previous page.

Standard Functions

Rolling pages:

Some information is displayed over several sub-pages. It is scrolled on your screen as it is received.

To stop scrolling, select **STOP** using the **Up/Down** keys and validate using **ok**. Press **ok** again to continue scrolling.

Masked text:

To reveal a hidden answer (for example in a quiz programme), select **???** using the **Up/Down** keys and validate using **ok**. Press **ok** again to hide the answers.

Zoom :

Select **ZOOM** using the **Up/Down** keys then press the **ok** key once to magnify the top of the screen, twice to magnify the bottom of the screen (the page will scroll from top to bottom) and a third time to return to the normal display.

Display:

You can superpose the Teletext page over the TV picture. To do this, select **MIX** using the **Up/Down** keys then validate by pressing the **ok** key. Press again **ok** to return to the normal display.

Sub-code:

You can use this to access a sub-page directly.

Select **" - - - "** using the **Up/Down** keys. Then enter the four digits of the required sub-page number.



Certain programmes have **Alarm** pages that you can set to appear at the time you require. For example: for 15h30 enter **1530** as the sub-page number then press **exit**. You must of course leave the television on the programme which is to transmit the **Alarm** page.

Index:

To call up the index page, select **100** using the **Up/Down** keys then validate using **ok**.

Direct access:

You can use the yellow and blue keys to directly access the pages indicated in the bar at the bottom of the screen.

Fasttext functions:

If the Teletext you receive is Fasttext, a sub-menu at the bottom of the screen appears which you can use to select from the 4 headings according to its colour.

To select a heading, press the key of the corresponding colour.

Toptext functions:

If the Teletext you receive is TOPtext, the pages are arranged into headings and sub-headings by subject.

You can select the first page of a heading directly by pressing the blue key, or the first page of a sub-heading by pressing the yellow key.

Other functions:

With certain Teletext channels, it is possible to have sub-titles overlaid on the screen for certain broadcasts as well as certain news flash updates.

The corresponding page number is indicated in the Teletext index.

Once you have found the page, the sub-title or the news flash will be overlaid onto the TV picture.

The navigation status bar disappears after a few seconds. To display it again, press the **text** key.

To exit Teletext, press **exit** or **text**.

Other Connections

The CINCH Video and Audio sockets (1)* are provided to connect a VHS or 8mm camcorder.

The S and CINCH Audio sockets (1)* are provided to connect a S-VHS or Hi-8 camcorder.



To use the appliance you have connected, press the **av** key several times until the AV3 programme is selected on the screen. When you switch off the connected appliance, the television will remain on the AV3 programme and you must use the numerical keys on the remote control to select a programme.

The headphone socket (2)* is provided to connect a headphone or earphones.



Connecting a set of headphones does not mute the sound from the loudspeakers of the TV set. Pressing the **AV** button will mute the sound through the speakers but not through the headphones.

Other Possibilities

Copying a cassette:

Plug the VCR **you wish to record to** into the SCART socket AV2.

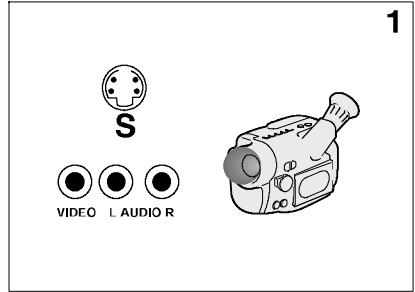

Plug the appliance **you wish to copy from** as follows: into the peripheral jack AV1 for a VCR; into the CINCH AV3 jacks for a camcorder (see table below).

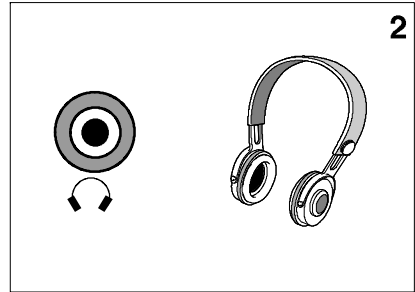

* on models equipped with this function

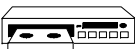

* on models equipped with this function

PLAY		RECORD		CALL PROGRAMME
Appliance	SCART Socket	Appliance	SCART Socket	
VCR 	Peripheral AV1	VCR ou Camcorder	AV2	AV1
Camcorder 	Cinches or S-Video AV3	VCR ou Camcorder	AV2	AV3

Speakers connection

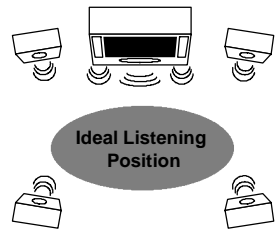
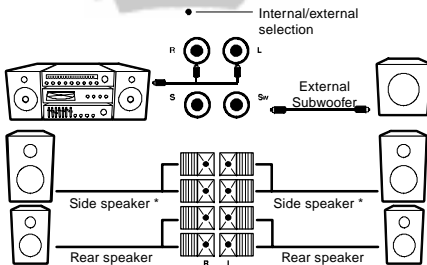

* If you have connected external side speakers to the television, set the internal/external selection button (located at the rear of the television set close to the connectors) to the external position (pushed down). Use the tip of a pen.

Euro-AV socket connections

The socket is shown as viewed from the rear of the TV.



NOTE : If an unsynchronised TV picture results after viewing an external source (with a fast blanking signal) connected to AV, this voltage must be removed to return to TV mode.

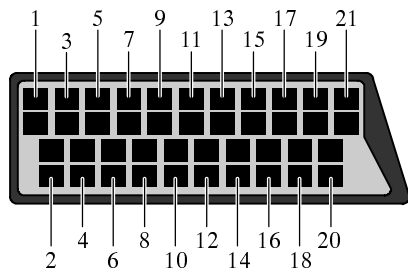

VIDEO INPUTS

Composite video or sync: Pin 20 (pin 17 return).

RGB:

Red Pin 15 (pin 13 return).

Green Pin 11 (pin 9 return).

Blue Pin 7 (pin 5 return).

VIDEO OUTPUT

Composite video: Pin 19 (pin 17 return).

AUDIO INPUTS

A: Pin 6 (pin 4 return).

B: Pin 2 (pin 4 return).

AUDIO OUTPUTS

A: Pin 3 (pin 4 return).

B: Pin 1 (pin 4 return).

FAST BLANKING (INPUT)

Pin 16, + 1 V to + 3 V for fast blanking switching, 75 W.

SIGNAL SELECTION

Facilities are provided for automatic switching when the equipment connected provides switching voltages as follows:

Pin 8: + 9.5 V to + 12 V

Auto switching to auxiliary O/AUX channel.

+ 4.5 V. to 7 V. 16/9 display

Pin 16: + 1 V. to + 3 V. Auto switching to RGB.

SIGNAL LEVEL

Composite video: 1 Vp - p \pm 3 dB positive going, 75 W (in/out)

Sync: 0.3 Vp - p - 3 dB + 10 dB, negative going, 75 W

RGB (input): 0.7 Vp - p \pm 3 dB, positive going, 75 W

Audio (in/out): 0.5 V r.m.s. (nominal)

Input impedance: . 10 kW (20 Hz - 20 kHz)

Output impedance: 3 1 kW (20 Hz - 20 kHz)



T H O M S O N
m u l t i m e d i a
Sales UK Limited
Crown road
Enfield Middlesex
EN 1 1DZ

253 408 80



THOMSON