

Watson-Marlow 620DuN / 620Du pumps



Contents

1	Declaration of conformity	3	18.4	Pump I/D	37
2	Declaration of incorporation	3	18.5	Baud	38
3	Five-year warranty	3	18.6	Stop bits	38
4	When you unpack your pump	4	18.7	Xon/Xoff	38
5	Information for returning pumps	5	18.8	Flow units	39
6	Peristaltic pumps - an overview	5	18.9	Run time	40
7	Safety notes	6	18.10	Outputs	40
8	Pump specifications	8	18.11	Remote stop	42
8.1	Pressure capability	12	18.12	Auto-restart	43
8.2	Dimensions	13	18.13	Set maximum allowed speed	44
9	Good pump installation practice	14	18.14	Set minimum allowed speed	44
9.1	General recommendations	14	18.15	Scrolling	45
9.2	Do's and do not's	15	18.16	Date and time	45
10	Connecting this product to a power supply	16	18.17	Backlight	46
11	Start-up check list	17	18.18	ROM	46
12	Switching the pump on for the first time	17	18.19	Language	47
13	Switching the pump on in subsequent power cycles (if not in auto-restart mode)	19	18.20	Defaults	47
14	Manual operation	20	18.21	Beep	48
14.1	Keypad functions	20	18.22	Security code	49
14.2	Speed	22	18.23	Exit	50
14.3	Direction	22	19	Pin out details	50
14.4	Keypad lock	23	20	MemoDose	52
14.5	Keypad beep	23	20.1	Changing dosing speed	53
14.6	Manual operation and remote digital inputs and outputs	23	20.2	Footswitch operation and other remote inputs and outputs with MemoDose	54
14.7	Backlight	24	21	Exit	54
14.8	Auto-restart	24	22	Automatic control wiring using the 620N module	55
15	Main menu	25	22.1	620N module removal and replacement	55
15.1	Keypad functions in menu screens	25	22.2	Wiring up	56
15.2	Main menu entry	25	22.3	Speed: analogue input	59
16	Pin-secure process protection	27	22.4	Scaling: analogue input	60
17	Head and tubing calibration	28	22.5	Speed: analogue output	61
18	Setup	31	22.6	Tachometer frequency output	61
18.1	Trim	32	22.7	Run/stop input	62
18.2	Analogue	33	22.8	Direction input	62
18.2.1	Input 1: speed	34	22.9	Auto / manual toggle input	63
18.2.2	Scaling - stroke	35	22.10	MemoDose input	63
18.2.3	Trim	36	22.11	Leak detection input	63
18.2.4	Exit	36	22.12	Outputs 1, 2, 3, 4	64
18.3	Display	36			

22.13	Supply voltages	64	29.8	620RE, 620RE4 and 620R tube element or continuous tube removal	91
22.14	RS485 input	65	29.9	620RE, 620RE4 and 620R maintenance	91
23	Automatic control wiring without the 620N module	66	29.10	620RE, 620RE4 and 620R CIP and SIP	94
23.1	Speed: analogue input 1	68	29.11	620RE, 620RE4 and 620R pumphead spares	95
23.2	Scaling: analogue input 2	69	30	620RE, 620RE4 and 620R performance data	97
23.3	Speed: analogue output	70	30.1	620RE, 620RE4 and 620R flow rates	98
23.4	Tachometer frequency output	70	31	620R continuous tubing product codes	100
23.5	Run/stop input	71	32	620RE and 620RE4 LoadSure tube element product codes	101
23.6	Direction input	71	33	620L and 620LG pumpheads	102
23.7	Auto / manual toggle input	72	33.1	620L and 620LG key safety information	102
23.8	MemoDose input	72	33.2	620L and 620LG guarding	102
23.9	Leak detection input	73	33.3	620L and 620LG pumping conditions	103
23.10	Pump status outputs	74	33.4	620L and 620LG removal and installation	103
23.10.1	Logic output 1	74	33.5	620L and 620LG tube loading	105
23.10.2	Logic output 2	75	33.6	620L and 620LG care and maintenance	106
23.10.3	Logic output 3	76	33.7	620L and 620LG track adjustment	106
23.10.4	Logic output 4	76	33.8	620L and 620LG pumphead spares	107
23.11	Supply voltages	77	34	620L and 620LG performance data	108
24	Automatic control and operation	78	34.1	620L and 620LG flow rates	108
25	Network control and operation	80	34.2	620L tubing codes	109
25.1	RS232 and RS485 command strings	82	34.3	620LG element codes	110
26	Troubleshooting	83	35	Pumping accessories	110
26.1	Error codes	84	36	Trademarks	111
27	Drive maintenance	85	37	Warning not to use pumps in patient-connected applications	111
28	Drive spares	85	38	Publication history	111
29	620RE, 620RE4 and 620R pumpheads	86	39	Decontamination certificate	112
29.1	620RE, 620RE4 and 620R Key safety information	86			
29.2	620RE, 620RE4 and 620R safe-guarding	86			
29.3	620RE, 620RE4 and 620R pumping conditions	87			
29.4	620RE, 620RE4 and 620R pump installation	87			
29.5	620RE, 620RE4 and 620R general operation	88			
29.6	620RE and 620RE4 tube element loading	89			
29.7	620R continuous tube loading	90			

DuN, Du

1 Declaration of conformity



This declaration was issued for Watson-Marlow 620DuN and 620Du pumps on September 19, 2005. When this pump unit is used as a stand-alone pump it complies with: Machinery Directive 98/37/EC, Low Voltage Directive 73/23/EC, EMC Directive 89/336/EC.



This pump is ETL listed: ETL control number 3050250. Cert to CAN/CSA std C22.2 No 61010-1. Conforms to UL std 61010A-1.

See 8 Pump specifications.

DuN, Du

2 Declaration of incorporation

When this pump unit is to be installed into a machine or is to be assembled with other machines for installations, it must not be put into service until the relevant machinery has been declared in conformity with the Machinery Directive 98/37/EC BS EN 60204-1.

Responsible person: Christopher Gadsden, Managing Director, Watson-Marlow Limited, Falmouth, Cornwall TR11 4RU, England. Telephone +44 (0) 1326 370370 Fax +44 (0) 1326 376009.

The information in this user guide is believed to be correct at the time of publication. However, Watson-Marlow Limited accepts no liability for errors or omissions. Watson-Marlow Bredel has a policy of continuous product improvement, and reserves the right to alter specifications without notice. This manual is intended for use only with the pump it was issued with. Earlier or later models may differ. The most up-to-date manuals appear on the Watson-Marlow website: <http://www.watson-marlow.com>

DuN, Du

3 Five-year warranty

520 cased pumps, 620 cased pumps and 720 cased pumps

For any 520, 620 or 720 cased pump purchased after 1 January 2007, Watson-Marlow Limited ("Watson-Marlow") warrants, subject to the conditions and exceptions below, through either Watson-Marlow, its subsidiaries, or its authorised distributors, to repair or replace free of charge, any part of the product which fails within five years of the day of manufacture of the product. Such failure must have occurred because of defect in material or workmanship and not as a result of operation of the product other than in normal operation as defined in this pump manual.

Watson-Marlow shall not be liable for any loss, damage, or expense directly or indirectly related to or arising out of the use of its products, including damage or injury caused to other products, machinery, buildings, or property, and Watson-Marlow shall not be liable for consequential damages, including, without limitation, lost profits, loss of time, inconvenience, loss of product being pumped, and loss of production. This warranty does not obligate Watson-Marlow to bear any costs of removal, installation, transportation, or other charges which may arise in connection with a warranty claim.

Conditions of and specific exceptions to the above warranty are:

Conditions

- Products must be returned by pre-arrangement, carriage-paid, to Watson-Marlow, or a Watson-Marlow approved service centre.
- All repairs or modifications must have been made by Watson-Marlow Limited, or a Watson-Marlow approved service centre or with the express permission of Watson-Marlow.
- Warranties purporting to be on behalf of Watson-Marlow made by any person, including representatives of Watson-Marlow, its subsidiaries, or its distributors, which do not accord with the terms of this warranty shall not be binding upon Watson-Marlow unless expressly approved in writing by a Director or Manager of Watson-Marlow.

Exceptions

- The warranty shall not apply to repairs or service necessitated by normal wear and tear or for lack of reasonable and proper maintenance.
- All tubing and pumping elements as consumable items are excluded.
- Products which, in the judgment of Watson-Marlow, have been abused, mis-used, or subjected to malicious or accidental damage or neglect are excluded.
- Electrical surge as a cause of failure is excluded.
- Chemical attack is excluded
- All pumphead rollers are excluded.
- The 620R family of pumpheads are excluded from all warranty when pumping above 2 bar while above 165rpm.
- Pumpheads from the 313/314 and the Microcassette ranges and any 701 extension pumpheads are excluded and retain their one-year standard pump-head warranty. The drive they are attached to is subject to the five-year warranty as set out here.
- Ancillaries such as leak detectors are excluded.

DuN, Du

4 When you unpack your pump

Unpack all parts carefully, retaining the packaging until you are sure all components are present and in good order. Check against the components supplied list, below.

Packaging disposal

Dispose of packaging materials safely, and in accordance with regulations in your area. The outer carton is made of corrugated cardboard and can be recycled.

Inspection

Check that all components are present. Inspect components for damage in transit. If anything is missing or damaged, contact your distributor immediately.

Components supplied

620Du and 620DuN pumps are available in two forms, dedicated to either 620R series pumpheads or 620L series pumpheads. Pumps are supplied as:

- Dedicated 620R pump drive unit fitted with 620R, 620RE or 620RE4 pumphead (see 8. Pump specifications); OR: Dedicated 620L pump drive unit fitted with 620L or 620LG pumphead (see 8. Pump specifications)
- A 620N module providing pump ingress protection to IP66, NEMA 4X, if a 620DuN.

Note: the module is attached for transit, but must be removed to allow wiring

up, voltage selection and fuse inspection and then re-affixed before the pump is operated.

- The designated mains power lead for your pump
- PC-readable CDROM containing these operating instructions
- Quick Start manual

Note: Some versions of this product will include components different from those listed above. Check against your purchase order.

Storage

This product has an extended shelf life. However, care should be taken after storage to ensure that all parts function correctly. Users should be aware that the pump contains a battery with an unused life of seven years. Long-term storage is not recommended for peristaltic pump tubing. Please observe the storage recommendations and use-by dates which apply to tubing you may wish to bring into service after storage.

DuN, Du

5 Information for returning pumps

Equipment which has been contaminated with, or exposed to, body fluids, toxic chemicals or any other substance hazardous to health must be decontaminated before it is returned to Watson-Marlow or its distributor.

A certificate included at the rear of these operating instructions, or signed statement, must be attached to the outside of the shipping carton. This certificate is required even if the pump is unused.

If the pump has been used, the fluids that have been in contact with the pump and the cleaning procedure must be specified along with a statement that the equipment has been decontaminated.

DuN, Du

6 Peristaltic pumps - an overview

Peristaltic pumps are the simplest pump, with no valves, seals or glands to clog or corrode. The fluid contacts only the bore of a tube, eliminating the risk of the pump contaminating the fluid, or the fluid contaminating the pump. Peristaltic pumps can run dry.

How they work

A compressible tube is squeezed between a roller and a track on an arc of a circle, creating a seal at the point of contact. As the roller advances along the tube, the seal also advances. After the roller has passed, the tube returns to its original shape, creating a partial vacuum which is filled by fluid drawn from the inlet port.

Before the roller reaches the end of the track, a second roller compresses the tube at the start of the track, isolating a packet of fluid between the compression points. As the first roller leaves the track, the second continues to advance, expelling the packet of fluid through the pump's discharge port. At the same time, a new partial vacuum is created behind the second roller into which more fluid is drawn from the inlet port.

Backflow and siphoning do not occur, and the pump effectively seals the tube when it is inactive. No valves are needed.

The principle may be demonstrated by squeezing a soft tube between thumb and

finger and sliding it along: fluid is expelled from one end of the tube while more is drawn in at the other.

Animal digestive tracts function in a similar way.

Suitable applications

Peristaltic pumping is ideal for most fluids, including viscous, shear-sensitive, corrosive and abrasive fluids, and those containing suspended solids. They are especially useful for pumping operations where hygiene is important.

Peristaltic pumps operate on the positive displacement principle. They are particularly suitable for metering, dosing and dispensing applications. Pumps are easy to install, simple to operate and inexpensive to maintain.

DuN, Du

7 Safety notes

In the interests of safety, this pump and the tubing selected should only be used by competent, suitably trained personnel after they have read and understood this manual, and considered any hazard involved. If the pump is used in a manner not specified by Watson-Marlow Limited, the protection provided by the pump may be impaired.



Any person who is involved in the installation or periodic maintenance of this equipment should be suitably skilled or instructed and supervised using a safe system of

 **This symbol, used on the pump and in this manual, means: Caution, risk of electric shock.**

 **This symbol, used on the pump and in this manual, means: Caution, refer to accompanying documents.**

 **This symbol, used on the pump and in this manual, means: Do not allow fingers to contact moving parts.**

 **This symbol, used on the pump and in this manual, means: Recycle this product under the terms of the EU Waste Electrical and Electronic Equipment (WEEE) Directive.**

   **There is a user-replaceable type T5A H 250V fuse in the fuseholder in the centre of the switchplate at the back of the pump. *The 620N module must be removed, if a 620DuN, to allow access to the switchplate. See 22.1 620N module removal and replacement. There are thermal fuses within the pump which self-reset within 60 seconds; if they trip an error code is displayed. This pump contains no user-serviceable fuses or parts.***



Fundamental work with regard to lifting, transportation, installation, starting-up, maintenance and repair should be performed by qualified personnel only. The unit must be isolated from mains power while work is being carried out.

work. In the UK this person should also be familiar with the Health and Safety at Work Act 1974.

There are moving parts inside the pumphead. Before opening the tool-unlockable fixed guard (620R) or tool-unlockable track (620L), ensure that the following safety directions are followed.

- Ensure that the pump is isolated from the mains power.
- Ensure that there is no pressure in the pipeline.
- If a tube failure has occurred, ensure that any fluid in the pumphead has been allowed to drain to a suitable vessel, container or drain.
- Ensure that protective clothing and eye protection are worn if hazardous fluids are pumped.
- Primary operator protection from rotating parts of the pump is provided by the pumphead fixed guard. Note that guards differ, depending on the type of pumphead. See the pumphead sections of this manual: 29 and 33.
- Secondary operator protection from rotating parts of the pump is provided by indicator-only switching of the pumphead guard. This function will stop the pump if the guard is inadvertently opened while the pump is running. For details of permissible pumphead orientations, see the pumphead sections of this manual: 29 and 33.

This pump must be used only for its intended purpose. The pump must be accessible at all times to facilitate operation and maintenance. Access points must not be obstructed or blocked. The pump's mains plug is the disconnecting device (for iso-



This product does not comply with the ATEX directive and must not be used in explosive atmospheres.

lating the motor drive from the mains supply in an emergency). Do not position the pump so that it is difficult to disconnect the mains plug. Do not fit any devices to the drive unit other than those tested and approved by Watson-Marlow. Doing so could lead to injury to persons or damage to property for which no liability can be accepted.

If hazardous fluids are to be pumped, safety procedures specific to the particular fluid and application must be put in place to protect against injury to persons.

The exterior surfaces of the pump may get hot during operation. Do not take hold of the pump while it is running. Let it cool after use before handling it.

No attempt should be made to run the drive without a pumphead fitted.

The pump weighs more than 18kg (the exact weight depends on model and pumphead—see 8 Pump specifications). Lifting should be performed according to standard Health and Safety guidelines. Finger recesses are built into the sides of the lower shell for convenience in lifting; in addition, the pump can conveniently be lifted by grasping the pumphead and (where fitted) the 620N module at the rear of the pump.

8 Pump specifications

DuN

Labels fixed to the rear of the pump contain manufacturer and contact details, product reference number, serial number and model details.



DuN, Du

The same information is carried on the drive's backplate, accessible when the 620N module is removed. The picture below is how a 620Du looks from the box. The number of connectors varies according to the model.

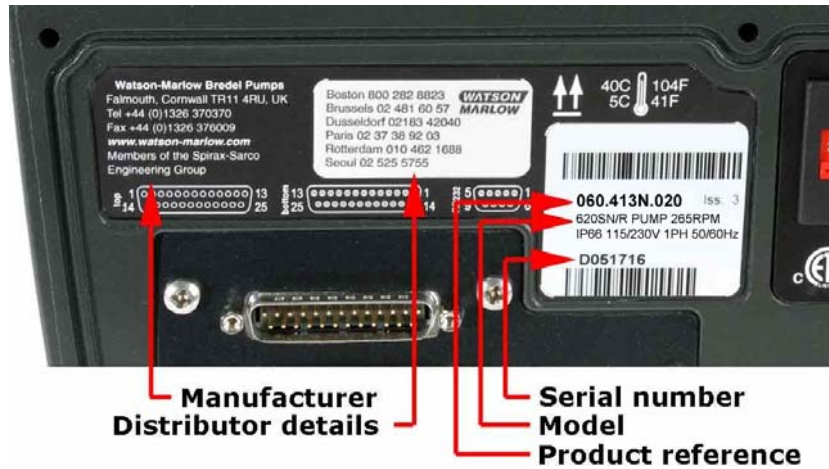

620DuN, IP66 NEMA 4X model and 620Du, IP31 model

This pump can be controlled from the keypad or remotely. It features:

Manual control

Speed adjustment; run and stop; direction control; keypad scaling; "max" key for rapid priming.

Remote control

The pump can be digitally controlled with a contact closure or logic input signal.

Analogue control

The pump speed can be controlled through an analogue signal input in the ranges 0-10V, 1-5V or 4-20mA. Scaling can be controlled similarly using Analogue signal input 2.

Outputs

A 0-10V, 4-20mA or 0-1478Hz output signal provides feedback of the pump speed. There are four relay status outputs which can be configured in software for a variety of pump parameters.

MemoDose

Allows repeat dosing. Stores in memory a pulse count from the motor. This count is repeated each time **START** is pressed to provide a single-shot dose.

Calibration

Full calibration with default figures for a range of pumpheads and tubes. Calibration dose facility.

Serial communications

Full pump control from a PC or other controller with the ability to network up to 16 pumps (620Du) or 32 pumps (620DuN).

Guard switch

Primary operator protection from rotating parts of the pump is provided by the fixed guard. Secondary operator protection from rotating parts of the pump is provided by indicator-only switching of the pumphead guard.

PIN-secure process protection

Two levels of control protection: main PIN code and user PIN code.

IP (Ingress Protection) and NEMA definitions

IP		NEMA
1st Digit	2nd Digit	
<p>3</p> <p>Protected against ingress of solid objects with a diameter of more than 2.5mm. Tools, wires etc with a thickness of more than 2.5mm are prevented from approach</p>	<p>1</p> <p>Protection against dripping water falling vertically. No harmful effect must be produced</p>	<p>2</p> <p>Indoor use to provide a degree of protection against limited amounts of falling water and dirt</p>
<p>5</p> <p>Protected against harmful dust deposits. Ingress of dust is not totally prevented but the dust must not enter in sufficient quantity to interfere with satisfactory operation of the equipment. Complete protection against contact</p>	<p>5</p> <p>Protection against water projected from a nozzle against the equipment (enclosure) from any direction. There must be no harmful effect (water jet)</p>	<p>12</p> <p>Indoor use to provide a degree of protection against dust, falling dirt and dripping, non-corrosive liquids</p>
		<p>13</p> <p>Indoor use to provide a degree of protection against dust and spraying of water, oil and non-corrosive coolants</p>
<p>6</p> <p>Protection against ingress of dust (dust-tight). Complete protection against contact</p>	<p>6</p> <p>Protection against heavy seas or powerful water jets. Water must not enter the equipment (enclosure) in harmful quantities (splashing over)</p>	<p>4X</p> <p>Indoor or outdoor use* to provide a degree of protection against splashing water, wind-blown dust and rain, hose-directed water; undamaged by the formation of ice on the enclosure. (Resist corrosion: 200-hour salt spray)</p>

* 620 cased pumps are rated to NEMA 4X (indoor use) only.

Pump specifications

Control range (turndown ratio)	0.1-265rpm (2650:1)
Supply voltage/frequency	Filtered 100-120V/200-240V 50/60Hz 1ph
Maximum voltage fluctuation	±10% of nominal voltage. A well regulated electrical mains supply is required along with cable connections conforming to the best practice of noise immunity
Installation category (overvoltage category)	II
Power consumption	250VA
Full load current	<1.1A at 230V; <2.2A at 115V
Eprom version	Accessible through pump software
Enclosure rating - 620DuN	IP66 to BS EN 60529; Equivalent to NEMA 4X to NEMA 250* (indoor use). Suitable for heavy industrial, process and filthy environments. The drive uses a Gore membrane vent to equalise the pressure inside the enclosure and to prevent ingress of water and corrosive vapours.
Enclosure rating - 620Du	IP31 to BS EN 60529. Equivalent to NEMA 2, suitable for indoor use. Protected against dripping water and falling dirt. May be wiped with a damp cloth, but should not be immersed.
Pumphead options (620R models)	620R, 620RE, 620RE4
Pumphead options (620L models)	620L, 620LG
Operating temperature range	5C to 40C, 41F to 104F
Storage temperature range	-25C to 65C, -13F to 149F
Maximum altitude	2,000m, 6,560ft
Humidity (non-condensing) (620Du)	80% up to 31C, 88F, decreasing linearly to 50% at 40C, 104F
Humidity (condensing) (620DuN)	10% - 100% RH
Weight	See table on previous page
Noise	<70dB(A) at 1m

* Protect from prolonged UV exposure.

Standards

EC harmonised standards	Safety of machinery—electrical equipment of machines: BS EN 60204-1
	Safety requirements for electrical equipment for measurement, control and laboratory use: BS EN 61010-1 incorporating A2 Category 2, Pollution degree 2
	Degrees of protection provided by enclosures (IP code): BS EN 60529 amendments 1 and 2
	Conducted emissions: BS EN 55011 A1 and A2, Class A, called by BS EN 61000-6-4
	Radiated emissions: BS EN 55011 A1 and A2, Class A, called by BS EN 61000-6-4
	Electrostatic discharge: BS EN 61000-4-2 A1 and A2
	Radiated RF immunity: BS EN 61000-4-3 A1 and A2, called by BS EN 61000-6-2
	Fast transient burst: BS EN 61000-4-4 A1 and A2, Level 3 (2kV), called by BS EN 61000-6-2
	Surge testing: BS EN 61000-4-5 A1 and A2, called by BS EN 61000-6-2
	Conducted RF immunity: BS EN 61000-4-6, called by BS EN 61000-6-2
	Voltage dips and interruptions: BS EN 61000-4-11, called by BS EN 61000-6-2
	Mains harmonics: BS EN 61000-3-2 Ed 2
	Safety of machinery—basic concepts, general principles of design: BS EN 292-1 and BS EN 292-2
	Pumps and pump units for liquids—common safety requirements: BS EN 809
	Other standards
CAN/CSA-C22.2 No 61010-1	
Conducted emissions FCC 47CFR, Part 15.107	
Radiated emissions FCC 47CFR, Part 15	
NEMA 4X to NEMA 250 (indoor use) for IP66 products only	

8.1 Pressure capability

0-4 bar higher pressure pumping

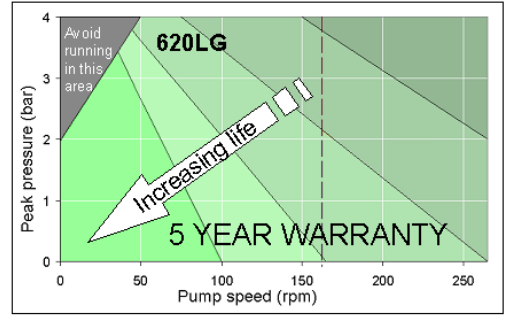
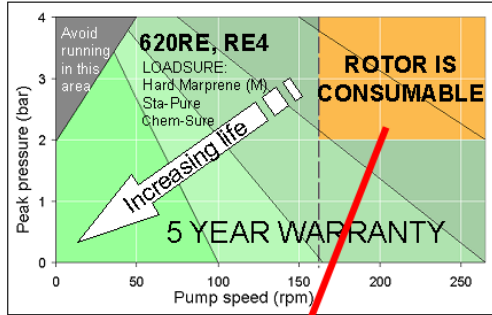

Over 165rpm and 2bar 620RE rotor is consumable
 ↶ to accept

This pump’s default running speed is 165rpm. It can be run at any speed up to 265rpm. Please note, however:

- The 620RE and 620RE4 rotor warranty is limited to 2 bar from 165rpm to 265rpm.
- A warning is displayed when the user sets the speed above 165rpm.
Note: Applies to 620RE MarkII and 620RE4 MarkII pumpheads only. (The 620LG is not limited).
- The pump’s software records the duration of operation above 165rpm.

0-2 bar pressure pumping

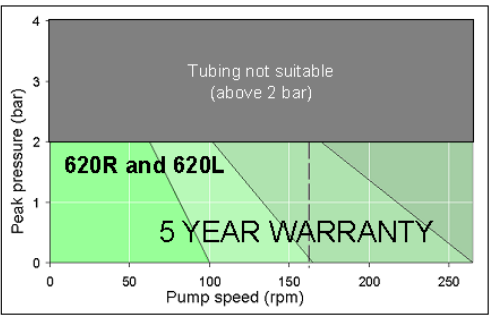
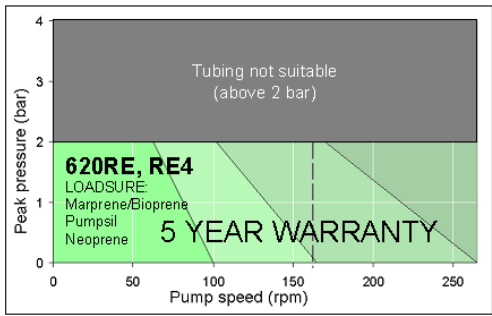

8.2 Dimensions

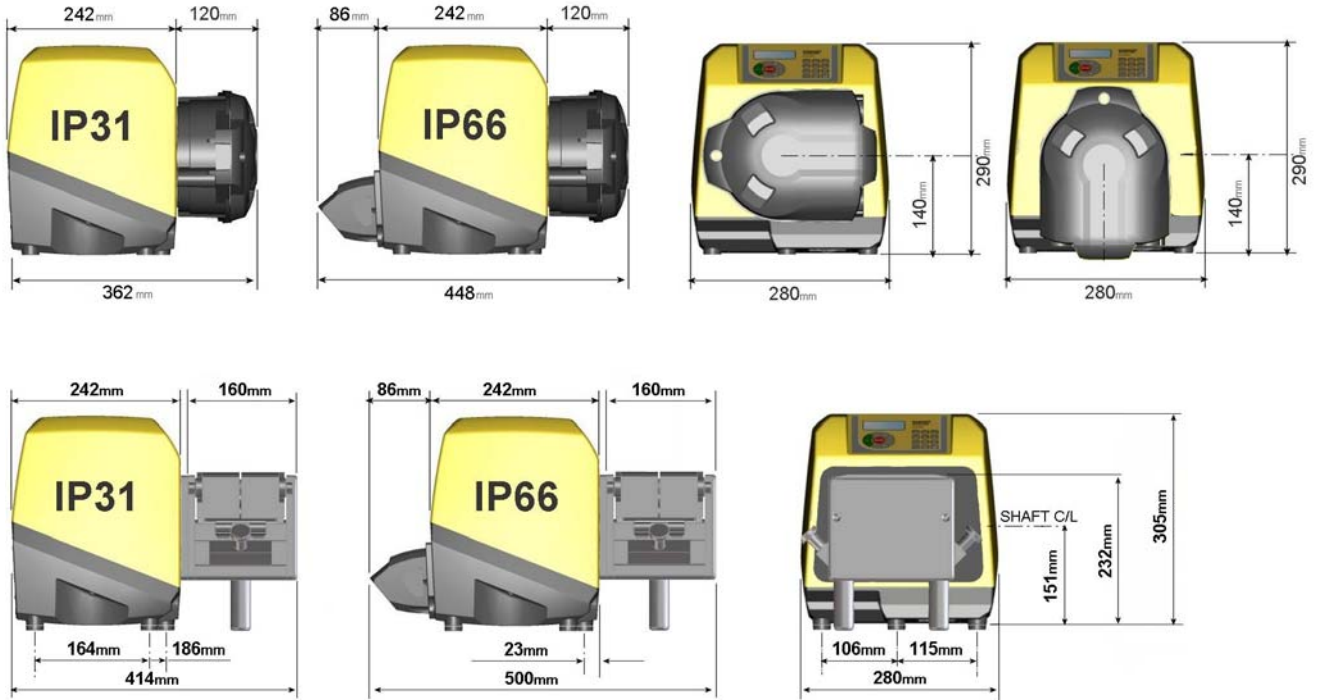

Unit weights

	Drive only	+ 620R, 620RE	+ 620RE4	+ 620L, 620LG
IP31	16.5kg, 36lb 6oz	19.6kg, 43lb 3oz	20.1kg, 44lb 5oz	24.3kg, 53lb 9oz
IP66 NEMA 4X	17.4kg, 38lb 6oz	20.5kg, 45lb 3oz	21.0kg, 46lb 5oz	25.2kg, 55lb 9oz

9 Good pump installation practice

9.1 General recommendations

Position

A correctly engineered installation will promote long tube life. Site the pump on a flat, horizontal, rigid surface, free from excessive vibration, to ensure correct lubrication of the gearbox. Allow a flow of air around the pump to ensure that heat can be dissipated. Ensure that the temperature around the pump does not exceed 40C.

Do not stack other 620 pumps on top of this pump. It is, however, acceptable to stack other equipment on the upper surface of the 620 (as long as the ambient temperature does not exceed 40C).

Emergency disconnection

The pump's mains plug is the disconnecting device (for isolating the motor drive from the mains supply in an emergency). Do not position the pump so that it is difficult to disconnect the mains plug. The **STOP** key on the keypad will always stop the pump. However, it is recommended that a suitable local emergency stop device is fitted into the mains supply to the pump.

Valves

Peristaltic pumps are self-priming and self-sealing against backflow. No valves are required in inlet or discharge lines. Valves in the process flow must be opened before the pump operates. Users are advised to fit a pressure relief device between the pump and any valve on the discharge side of the pump to protect against damage caused by accidental operation with the discharge valve closed.

The pump may be set up so that the direction of rotor rotation is clockwise or counter-clockwise, whichever is convenient.

Tubing materials: run-in advice

Sta-Pure and Marprene TM tubing are hard to compress when new. When using tubing made of these materials, the first five pumphead revolutions should be at a speed of 10rpm or greater. If the pump is run slower, the safety system built into pump drive's software may cause it to stop and display an over-current error message.

Pressure advice

In most circumstances, rotor and tube life are maximised if the pumphead is run slowly, particularly when pumping at high pressure. However, to maintain performance at pressures above 2 bar, avoid running the pumphead below 50rpm. If low-flow, high-pressure operation is necessary, switching to a smaller tube is recommended.

9.2 Do's and do not's

Do not build a pump into a tight location without adequate airflow around the pump.

Do ensure that when the 620N watertight module is fitted the seals are intact and properly located. Ensure that the holes for cable glands are properly sealed to maintain the IP66 / NEMA 4X rating.

Do not strap the control and mains power cables together.

Do keep delivery and suction tubes as short and direct as possible - though ideally not shorter than 1m - and follow the straightest route. Use bends of large radius: at least four times the tubing diameter. Ensure that connecting pipework and fittings are suitably rated to handle the predicted pipeline pressure. Avoid pipe reducers and lengths of smaller bore tubing than the pumphead section, particularly in pipelines on the suction side. Any valves in the pipeline (not usually needed) must not restrict the flow. Any valves in the flow line must be open when the pump is running.

Do use suction and delivery pipes equal to or larger than the bore of the tube in the pumphead. When pumping viscous fluids use pipe runs with a bore several times larger than the pump tube.

Do ensure that on longer tube runs at least 1m of smooth bore flexible tubing is connected to the inlet and discharge port of the pumphead to help to minimize impulse losses and pulsation in the pipeline. This is especially important with viscous fluids and when connecting to rigid pipework.

Do site the pump at or just below the level of the fluid to be pumped if possible. This will ensure flooded suction and maximum pumping efficiency.

Do keep the pumphead track and all moving parts clean and free from contamination and debris.

Do run at slow speed when pumping viscous fluids (though see Pressure advice in 9.1 General recommendations). Flooded suction will enhance pumping performance in all cases, particularly for materials of a viscous nature.

Do recalibrate after changing pump tubes, fluid, or any connecting pipework. It is also recommended that the pump is recalibrated periodically to maintain accuracy.

IP66 / NEMA 4X models may be hosed down, but should not be immersed. Protect from prolonged UV exposure.

IP31 models may be wiped with a damp cloth, but should not be hosed or immersed. The front of IP31 models is further protected against light spillages onto the pump.

When using Marprene or Bioprene continuous tubing, do re-tension the tube after the first 30 minutes of running.

Tube selection: The chemical compatibility lists published in Watson-Marlow publications are guides. If in doubt about the compatibility of a tube material and the duty fluid, request a Watson-Marlow tube sample card for immersion trials.

DuN, Du

10 Connecting this product to a power supply

A well regulated electrical mains supply is required along with cable connections conforming to the best practice of noise immunity. It is not recommended to site these drives alongside "dirty" electrical mains supplies such as 3-phase contactors and inductive heaters without special attention being paid to unacceptable mains-borne noise.



The voltage selector is mounted in the switchplate at the rear of the pump, protected from water by the 620N module (620DuN). The module must be removed to allow access to the switchplate. See 22.1 620N module removal and replacement. Set the voltage selector to 115V for 100-120V 50/60Hz supplies or 230V for 200-240V 50/60Hz supplies. Always check the voltage selector switch before connecting the mains supply. Make suitable connection to an earthed, single-phase mains electricity supply.



We recommend using commercially available supply voltage surge suppression where there is excessive electrical noise.

Power cable: The pump is supplied fitted with either of two cable glands and approximately 2.8m of power cable. The European cable is to Harmonised code H05RN-F3G0.75, used with our gland part number SL0128 which is suitable for an outside cable sheath diameter of 4-7mm. The north American cable is to type SJTOW 105C 3-18AWG VW-1 used with our gland part number SL0123 which is suitable for an outside cable sheath diameter of 7-9mm.

DuN

Power cables of NEMA 4X specification pumps are fitted with a standard US mains power plug. IP66 specification pumps are supplied with no plug. Wiring a mains plug must only be undertaken by suitably skilled, qualified personnel.

Conductor coding

	European	North American
line	brown	black
neutral	blue	white
ground	green/yellow	green

DuN



The voltage selector switch is not visible while the 620N module is in place. Do not switch the pump on unless you have checked that it is set to suit your power supply by removing the module and inspecting the switch, and then refitting the module. See 22.1 620N module removal and replacement.

DuN, Du

If the mains power cable is inappropriate for your installation, it can be changed. Please contact your local Watson-Marlow Bredel service centre.



Input line fusing: type T5A H 250V 20mm time-delayed cartridge fuse, located in a fuseholder in the centre of the switchplate at the rear of the pump.

Power interruption: This pump has an auto-restart feature which, when active, will restore the pump to the operating state it was in when power was lost. See 18.12 Auto-restart.

Stop / start power cycles: Do not power up/power down for more than 100 starts per hour, whether manually or by means of the auto-restart facility. We recommend remote control where a high number of starts is required.

DuN, Du

11 Start-up check list

Note: See also 29.6, 29.7, 29.8 and 33.5, Tube loading.

- Ensure that proper connections are achieved between the pump tube and suction and discharge piping.
- Ensure proper connection has been made to a suitable power supply.
- Ensure that the recommendations in section 9 Good pump installation practice are followed.

DuN, Du

12 Switching the pump on for the first time

Note: This manual uses **bold** type to highlight the active option in menu screens: “**English**” in the first screen represented here. The active option appears on the pump display in **inverse** text.

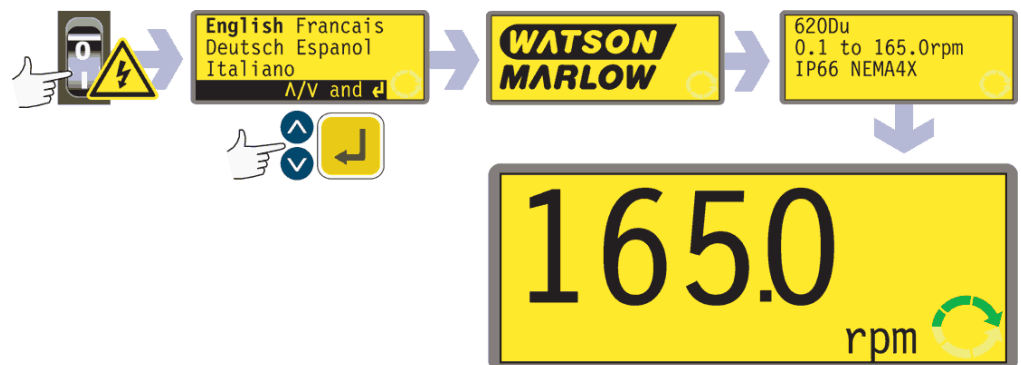

- Switch on the power supply at the rear of the pump. The pump runs a power-on test to confirm proper functioning of the memory and hardware. If a fault is found, an error message is displayed. See 26.1 Error codes.
- The pump displays a language menu. Use the **UP** and **DOWN** keys to select your language. Press the **ENTER** key to confirm your choice.
- **The information which follows assumes that your choice was English.**

- When the language is chosen this menu will not appear again and all menus will appear in the language you chose. (Language can be reset as described later. See 18.19 Language.)
- The pump displays the Watson-Marlow start-up screen for four seconds, followed by the pump model identity screen for four seconds, and then the manual mode main screen.
- The rotation symbol on the display indicates clockwise rotation. The default speed setting is 165rpm, but 265rpm is available (see 18.13 Set maximum allowed speed). Other initial start-up operational parameters are listed in the table below.

First-time start-up defaults			
Language	Not set	Analogue input	4-20mA
Speed	165rpm	User trim	None
Direction	Clockwise	Remote stop	Open=run
Pumphead	620R	Pump number	1
Tube size	15.9mm	Baud rate	9600
Calibration	620R 15.9mm tube	Stop bits	2
Backlight	On	Xon/Xoff	Off
Keypad lock	Off	Scrolling increment	0.1rpm
Auto-restart	Off	Output 1	Run/Stop *
Scaling	Off	Output 2	Direction †
Pump status	Stopped	Output 3	Auto/Man ‡
Beeper	On	Output 4	General alarm
Manual screen	rpm	* Run	= high
Security code	Not set	† Clockwise rotation	= high
		‡ Auto	= high

Note: The settings shown above for Run, Clockwise rotation and Auto are those in force on initial start-up for the functions available on Output 1, Output 2 and Output 3 respectively. For example, a high signal on Output 2 indicates clockwise rotation. These can be changed later according to user requirements.

Note: High is equivalent to the common and normally open contacts of the relay on the adapter board being closed.

The pump is now ready to operate according to the defaults listed above.

All operating parameters may be changed by means of key-presses. See 14 Manual operation.

13 Switching the pump on in subsequent power cycles (if not in auto-restart mode)

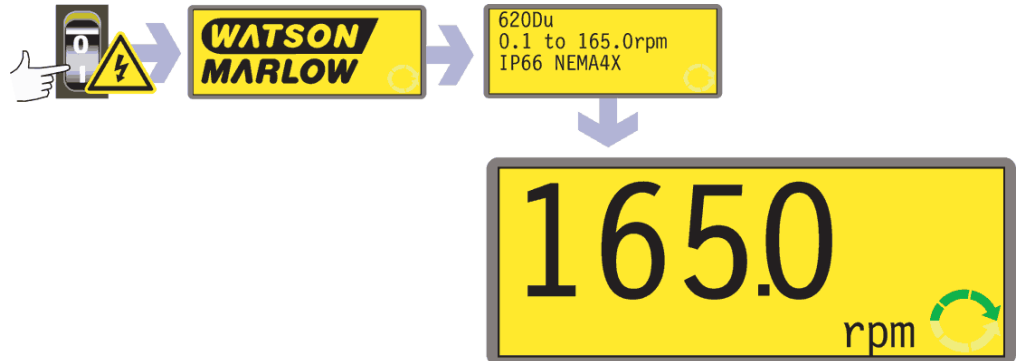

- Switch on the power supply at the rear of the pump. The pump runs a power-on test to confirm proper functioning of the memory and hardware. If a fault is found, an error message is displayed. See 26.1 Error codes.
- The pump displays the Watson-Marlow start-up screen for four seconds followed by the pump model identity screen for four seconds, and then the manual mode main screen.
- **Note:** Once in the manual mode main screen, keys assume their normal functions - see 15.1 Keypad in menu screens below. A subsequent press on **START** causes the pump to operate.
- Start-up defaults are those in place when the pump was switched off last. Check that the pump is set to operate as you require it.

The pump is now ready to operate.

All operating parameters may be changed by means of key-presses. See 14 Manual operation below.

14 Manual operation

14.1 Keypad functions

All settings and functions of the pump in manual mode are set and controlled by means of key-presses. Immediately after the start-up display sequence detailed above, the manual mode main screen will be displayed. The currently selected rotation direction is indicated on the display by a clockwise or counter-clockwise segmented arrow. If an exclamation mark (!) shows, it indicates that Auto-restart is on. If a padlock icon () shows, it indicates that Keypad lock is on.

Note: A number of the controls listed below are shortcuts to commands which are also available through the Main menu. See 15 Main menu.

Note: **SHIFT** gives access to functions which appear on the upper part of numeric keys. To access the **MAX** function, for example, press **SHIFT** once *and release it*. A symbol appears in the bottom left of the display to indicate that the next keypress will be **SHIFTed**. Press **4 (MAX)**.



A brief single press on each key triggers a beep sound (if enabled - see 14.5 Keypad beep) and causes the pump to function as follows:

- **START:** starts the pump at the speed and in the direction shown on the display. The rotation symbol will become animated to confirm that the pump is operating.

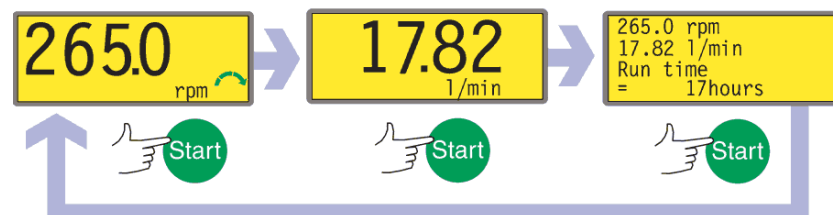

If the pump is running when **START** is pressed, it causes the information shown on the manual mode main screen to cycle from revolutions per minute, to flowrate in a choice of units (via a warning screen if flowrate has not been calibrated and if this is the first cycle since power-up) to rpm, flowrate and Run time. An example is shown here. The default can be altered from within the Setup menu (see 18.3 Display).

- **MAX (SHIFT, 4):** while pressed, **MAX (SHIFT, 4)** operates the pump at the maximum allowed speed and in the direction shown on the display. When released, the pump returns to its previous status.
Note: Priming can be achieved by pressing **MAX (SHIFT, 4)** until fluid flows through the pump and reaches the point of discharge, and then releasing **MAX (SHIFT, 4)**.

- **AUTO (SHIFT, 9)**: has no effect if the pump is running in auto mode. Stops the pump if it is running in Manual mode and displays a screen offering three choices: manual control, analogue control or network control. Use the **UP** and **DOWN** keys to make a choice. Press the **ENTER** key to confirm your decision. When started under analogue or network control, the pump runs at the speed set by any analogue or serial communications signal applied to the pump, and in the direction shown in the display.

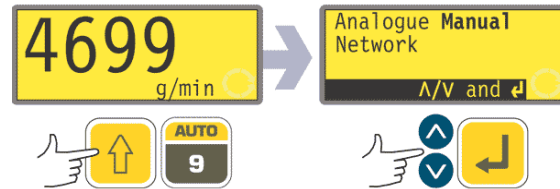

- **MAN (SHIFT, 6)**: stops the pump if it is running in an auto mode and displays the manual mode main screen. Has no effect if the pump is already running in manual mode.
- **STOP**: if the pump is running, pressing **STOP** stops the pump. The display will continue to show the previous speed and direction. The pump will return to this speed and direction when the **START** key is pressed again.
- **UP**: increases the speed shown on the display in minimum steps of 0.1rpm, or other steps as pre-selected in the Scrolling section of Setup (18.15), (unless the speed displayed is already the maximum allowed speed). If the pump is then started by pressing the **START** key, it will operate at the new speed. If the pump is running when **UP** is pressed, the change takes effect immediately. **Note**: If the pump's flow rate has been calibrated (see 17 Calibration), after a speed change a screen showing the new rpm figure and the new flowrate is displayed for four seconds before returning the user to the previously set manual mode main screen: rpm or flowrate.
- **DOWN**: decreases the speed shown on the display in minimum steps of 0.1rpm, or other steps as pre-selected in the Scrolling section of Setup (18.15). If the pump is then started by pressing the **START** key, it operates at the new speed. The minimum speed possible is 0.1rpm. If the pump is running when **DOWN** is pressed, the change takes effect immediately. **Note**: If the pump's flow rate has been calibrated (see 17 Calibration), after a speed change a screen showing the new rpm figure and the new flowrate is displayed for four seconds before returning the user to the previously set manual mode main screen: rpm or flowrate. **Note**: You can reduce the pump speed from 0.1rpm (or any other minimum displayed unit of speed as selected in the Scrolling section of Setup (18.15)) to 0rpm by a further press on the **DOWN** key. The pump is still in the running state and the rotation symbol will continue to move. Press the **UP** key to return the pump to the minimum speed. **Note**: If a minimum allowed speed has been set in the Set Min Speed section of the Setup menu, the above note on speed reduction to 0rpm does not apply.
- **DIRECTION (SHIFT, 1)**: toggles the direction of rotation shown on the display. If the pump is then started by pressing the **START** key, it rotates in the new direction. If the pump is running when **DIRECTION** is pressed, the change takes effect immediately.
- **ENTER**: is used to enter/confirm numeric and menu selections. Also cycles the information shown on the manual mode main screen exactly as **START** does, whether the pump is running or not. See **START**, above.
- **MENU (SHIFT, 7)**: causes the main menu to be displayed, from which all aspects of pump setup can be controlled. See 15 Main menu.
- **CLEAR (SHIFT, 5)**: clears numeric entries so that they can be entered again.
- **CAL (SHIFT, 8)**: takes the user to the calibrate sequence.
- **. (decimal point, period) (SHIFT, 0)**: used in numeric expressions as a decimal point. To enter 5.3, press 5, SHIFT, 0, 3. (Some languages use , (comma) to represent a decimal point. This pump uses .)

Keypress combinations cause the pump to function as follows:

Note: A number of the controls listed below are shortcuts to commands which are also available through the Main menu. See 15 Main menu.

- **UP** and **1 (DIRECTION)** on power-up: toggles the **keypad beep** on and off.
- **START** on power-up: switches on the **Auto-restart** facility. See 18.12 Auto-restart.
- **STOP** on power-up: switches off the **Auto-restart** facility. See 18.12 Auto-restart.
- **STOP** and **UP** while the pump is stopped: turns the **display backlight** on.
- **STOP** and **DOWN** while the pump is stopped: turns the **display backlight** off.
- **SHIFT** and **UP**: sets the pump to maximum allowed speed. **Note:** Unlike its action elsewhere, **SHIFT** must be pressed and held. **Note:** The **MAX** key has a similar function, but causes the pump to run at maximum allowed speed only while the key is pressed.
- **SHIFT** and **DOWN**: sets the pump to minimum allowed speed. **Note:** Unlike its action elsewhere, **SHIFT** must be pressed and held.
- **1 (DIRECTION)** and **DOWN**, pressed simultaneously: interrupts the display to show the pump's ROM version for four seconds.
- **START** pressed and held for four seconds: toggles the keypad lock on and off. Only the **START** and **STOP** keys are active when keypad lock is on. The pad-lock icon is displayed.
- **STOP** pressed and held for two seconds: toggles the **keypad lock** on and off. Only the **START** and **STOP** keys are active when keypad lock is on. The pad-lock icon is displayed.
- **STOP STOP** within half a second: shortcut entry to MemoDose; when in MemoDose, shortcut return to manual mode main screen. See 20 MemoDose.

14.2 Speed

To change the running speed:

- Use the **UP** and **DOWN** keys to change the pump's running speed within limits of 0.1 rpm or other minimum allowed speed and the maximum allowed speed. **Note:** You can reduce the pump speed from 0.1 rpm to 0 rpm by a further press on the **DOWN** key. The pump is still in the running state and the rotation symbol will continue to move. Press the **UP** key to return the pump to the minimum speed.

Note: The maximum allowed speed of the drive defaults to 165rpm. It is possible to set this limit at any speed up to 265rpm. See 18.13 Set maximum allowed speed, and section 3 Three-year warranty.

14.3 Direction

To toggle the pump's rotation sense:

- Press **DIRECTION (SHIFT, 1)** to toggle the pump between clockwise and counter-clockwise rotation. **Note:** Direction control is available subject to access not being limited by security code. See 18.22 Security code.

14.4 Keypad lock

The keypad can be locked to prevent changes to pump speed or other settings, and make it possible only to start or stop the pump. The padlock symbol shows on the display.

- While the pump is running, hold down the **START** key for two seconds. The padlock symbol shows and only the **START** and **STOP** keys function.
- The keypad may also be locked while the pump is stopped. Hold down the **STOP** key for two seconds. The padlock symbol shows and only the **START** and **STOP** keys function.
- To unlock the keypad while the pump is running hold down the **START** key for two seconds. The padlock symbol is removed. If the pump is stopped hold down the **STOP** key until the padlock symbol is removed.

Note: Keypad lock is available subject to access not being limited by security code. See 18.22 Security code.

14.5 Keypad beep

The pump keypad can operate silently or indicate a positive key-press with a beep sound.

- To toggle the sound on and off, stop the pump. Turn off the mains power switch at the rear of the pump.
- Depress the **UP** and **1 (DIRECTION)** keys while switching on the mains power switch at the rear of the pump.

See 18.21 Beep.

14.6 Manual operation and remote digital inputs and outputs

The remote run/stop, direction and leak-detected inputs are operational.

The remote status outputs are all fully functional.

The **STOP** key acts as an emergency stop. The run/stop input will not start the pump in manual mode, but once the **START** key has been pressed, the remote run/stop input will stop and start the pump according to its operational state.

(620DuN) If you invert the operation of the remote run/stop switch to operate as open=stop, you must connect the +5V terminal to the i/p terminal on the Run/stop input connector (J4), to be able to start the pump from the keypad. See 22.7 Run/stop input.

(620Du) If you invert the operation of the remote run/stop switch to operate as open=stop, you must connect pin 7 to pin 19, lower D-connector, to be able to start the pump from the keypad. See 22.7 Run/stop input.

If **STOP** is pressed the remote run/stop switch will have no effect.

You cannot invert the polarity of the remote direction signal.

14.7 Backlight

To turn the display backlight on:

- Depress the **STOP** and **UP** keys together.

To turn the display backlight off:

- Depress the **STOP** and **DOWN** keys together.

See 18.17 Backlight.

14.8 Auto-restart

This pump offers an auto-restart feature. When active on power loss, it will restore the pump when power returns to the operating state it was in when power was lost. It does not operate when powering down in the middle of a dose; when the pump is restarted, it will await a press on the **START** key to begin the interrupted dose again. Auto-restart is retained while the pump is switched off. When the pump starts running look for the ! symbol on the display. This ! symbol indicates that the pump is set for auto-restart.



Do not use auto-restart for more than 100 starts per hour. We recommend remote control where a high number of starts is required.

To turn the auto-restart facility on:

- Turn off the mains power switch at the rear of the pump.
- Depress the **START** key while switching on the mains power switch at the rear of the pump.

To turn the auto-restart facility off:

- Turn off the mains power switch at the rear of the pump.
- Depress the **STOP** key while switching on the mains power switch at the rear of the pump.

15 Main menu

15.1 Keypad functions in menu screens

In addition to their functions in other operations, the following keys have specific actions in menu screens:

- **STOP**: In general, **STOP** functions as a “go back” key, taking the user up one menu level without making a change.
- **UP**: The **UP** key is used in menu item selection: it moves a highlight up the menu. When a numerical entry screen is displayed, pressing **UP** increases the number displayed.
- **DOWN**: The **DOWN** key is used in menu item selection: it moves a highlight down a menu. When a numerical entry screen is displayed, pressing **DOWN** decreases the number displayed.
- **ENTER**: The **ENTER** key functions in a similar way to the “enter” key of a personal computer: it confirms key-presses made immediately before. In menu item selection, it triggers the action or display selected from a menu using the **UP** and **DOWN** keys.

Note: Confirmation screens are displayed for 4 seconds. While they are displayed, a single press on any key removes them.

15.2 Main menu entry

MENU (SHIFT, 7) displays the main menu and stops the pump if it is running in Manual mode. It operates at any point in the pump’s activity except where error screens are displayed, where **UP** and **DOWN** keys are used to enter values, or where a PIN is requested.



The main menu offers five options: **Calibrate**, **Setup**, **Pin out details**, **MemoDose** and **Exit**. Use the **UP** and **DOWN** keys to make a choice. Press the **ENTER** key to confirm your decision.

Calibrate

Calibrate allows the user to calibrate the pump with default figures for a range of pumpheads and tubes, as well as to refine the flowrate figures with a calibration dose facility.

Setup

Setup allows the user to set the pump’s operating parameters under 23 headings: Trim, Analogue, Display, Pump I/D, Baud, Stop bits, Xon/Xoff, Flow units, Run time, Outputs, Remote stop, Auto-restart, Set max speed, Set min speed, Scrolling, Date/time, Backlight, ROM, Language, Defaults, Beep, Security code and Exit.

Pin out details

Du

Selecting **Pin out details** causes the pump to display an information screen and then its preset pin and voltage details under 19 headings: Analogue input 1, Analogue input 2, Analogue output, Tacho output, Direction enable, Direction input, Run/Stop input, Leak input, Auto/Man toggle, Dose input, Output 1, Output 2, Output 3, Output 4, Supply, 0 volts, Earth, Others and Exit.

DuN

Pin out information is not relevant to the 620DuN IP66/NEMA 4X pumps. Selecting **Pin out details** causes the pump to display a warning screen and redisplay the main menu.

DuN, Du

MemoDose

The **MemoDose** facility is used to remember the number of revolutions needed to dispense a previously dispensed volume of fluid, and cause the pump to dispense that volume repeatedly.

Exit

If **Exit** is selected, the pump returns to its last manual state with the pump stopped.



16 PIN-secure process protection

The 620DuN and 620Du feature PIN-secure process protection. This allows the pump to be configured to suit the application, and for the setup to be protected by two levels of PIN code.

Menu option or keypress	With Main code set	With User code set	Code set and keypad locked
Menu (SHIFT, 7)	Available	Available	Not available
Calibrate	Available	Available	Not available
Accept	Available	Available	Not available
Change	Main PIN needed	Main PIN or User PIN needed	Not available
Setup	Main PIN needed	Main PIN needed; User PIN invalid	Not available
Cal (SHIFT, 8)	Available	Available	Not available
Accept	Available	Available	Not available
Change	Main PIN needed	Main PIN or User PIN needed	Not available
Max (SHIFT, 4)	Available	Available	Not available
Dir (SHIFT,1)	Main PIN needed	Main PIN or User PIN needed	Not available
Auto (SHIFT, 9)	Available	Available	Not available
Man (SHIFT, 6)	Available	Available	Not available
Up	Available	Available	Not available
Down	Available	Available	Not available
SHIFT and Up	Available	Available	Not available
SHIFT and Down	Available	Available	Not available
Start	Available	Available	Available
Stop	Available	Available	Available
Enter	Available	Available	Not available
MemoDose	Available	Available	Available
Keypad lock	Main PIN needed	Main PIN or User PIN needed	Main PIN or User PIN needed
Auto-restart	Available	Available	Available

The main code gives access to **Calibrate, Setup, Direction** change and **Keypad lock**.

The secondary (User) code permits **Calibrate, Direction** change and **Keypad lock** but bars **Setup** change.

If either code is used in conjunction with Keypad lock, all keys are disabled except **STOP** and **START**.

To activate and set a security code, see 18.22 Security code.

If the main code is lost or forgotten: The Setup main security code can be bypassed by entering a special key sequence; all codes can then be cancelled and reset. Contact Watson-Marlow or your distributor for details.

17 Head and tubing calibration

The pump can display flowrate in a choice of units as well as speed in revolutions per minute. It must first be calibrated.

Pump calibration can be limited to users who correctly enter a three-digit security code. If a security code has been set, selecting **Change** from the calibration details screen and confirming with the **ENTER** key causes the pump to display the Security code entry sequence. See 18.22 Security code. If no security code has been set, the pump displays the first screen of the calibration sequence.

To dispense the correct amount of fluid the pump must know which pumphead is fitted and the tube size in the pumphead. The pump is pre-programmed with default flow rate figures for a range of pumpheads and tubes. You may also measure the flow from the pump and enter this value for the most accurate calibration.

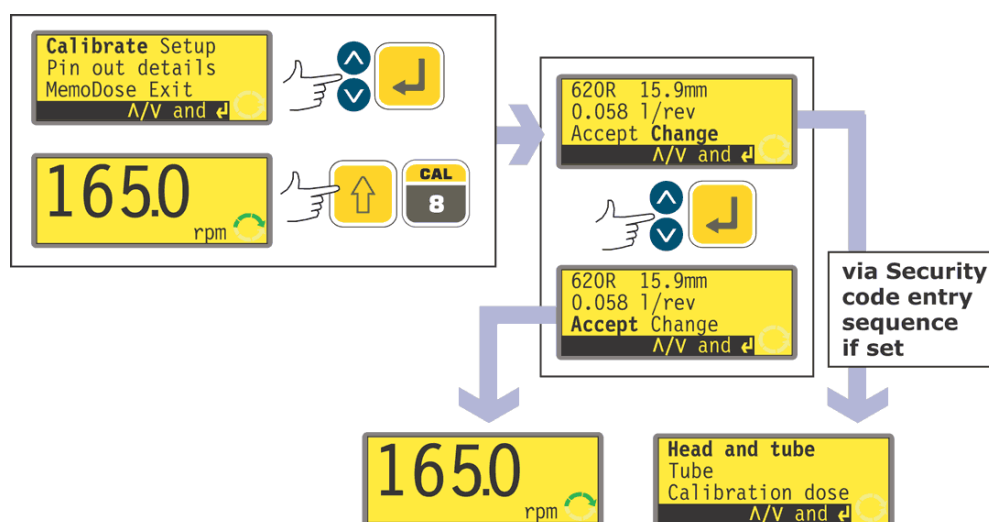

- Use the **UP** and **DOWN** keys to highlight **Calibrate** in the main menu. Press **ENTER** to confirm.

Alternatively ...

- Press **CAL (SHIFT, 8)** to enter the calibration screen from the main running screen, and return there after calibrating.

Then:

- The pump displays its current settings: pumphead, tube size and flowrate; the default for each standard pumphead is the largest tube the pumphead can take. Example information is shown here.
- Use the **UP** and **DOWN** keys to highlight **Accept** or **Change**. Press **ENTER** to confirm.
- If **Accept** is selected, the default or previously set flowrate data for that pumphead and tube size are used. The pump displays the main running screen.
- If **Change** is selected with a security code in place, the pump starts its security code entry sequence. See 18.22 Security code. When the correct code is entered, the pump offers three options: **Head and tube**; **Tube**; and **Calibration dose**. If **Change** is selected with no security code in place, the three options are displayed immediately.
- Use the **UP** and **DOWN** keys to make a selection. Press **ENTER** to confirm.

Head and tube



- If **Head and tube** is selected, the pump displays a list of standard pumpheads that can be fitted to the pump.
- Use the **UP** and **DOWN** keys to make a selection. Press **ENTER** to confirm. An example is shown here.
- The pump displays tube sizes, as below.

Tube

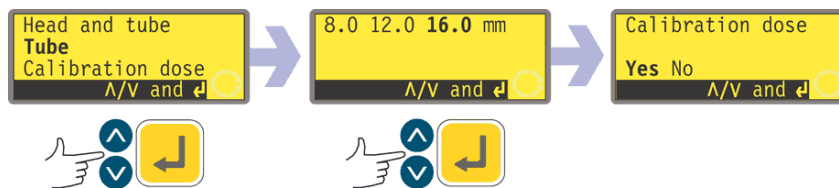

- If **Tube** is selected or a pumphead choice has just been made, the pump displays a list of standard tube sizes that can be used in the pumphead previously identified.
- Use the **UP** and **DOWN** keys to make a selection. Press **ENTER** to confirm.

Calibration dose

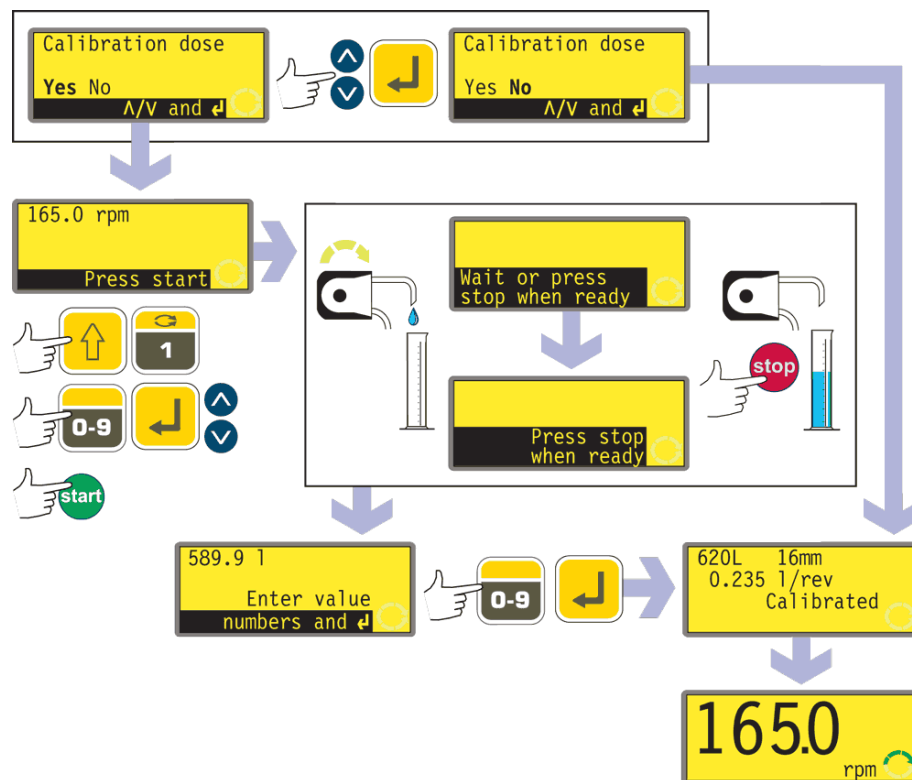

- The pump offers to run a calibration dose. Use the **UP** and **DOWN** keys to choose **Yes** or **No**. Press **ENTER** to confirm. Examples are shown here.
- If **No** is selected after a tube selection has been made (see Tube above), the pump briefly displays a confirmation screen showing current head, tube and flow settings, and redisplay the main menu.
- If **Calibration dose** is selected or if **Yes** is selected after a tube selection has been made (see Tube above), the pump displays the speed and direction at which it was last running in manual mode or to which it has just been set and invites the user to press **START**.
- **Note:** it is possible at this point to change the direction of rotation using the **DIRECTION (SHIFT, 1)** key, and to change the speed of rotation using the numeric keys (followed by **ENTER**), or the **UP** and **DOWN** keys, within the minimum and maximum limits that have been set. See 18.13 Set maximum speed and 18.14 Set minimum speed.
- Put a measuring container at the pump outlet. Press **START**. The pump runs for 4 minutes, displaying an information screen for 15 seconds and a further information screen for the rest of the 4 minutes. You may stop the calibration dose at any time with the **STOP** key - but allow the pump to run as long as possible to obtain the most accurate calibration. A minimum of 15 seconds is recommended.

- Measure the quantity of fluid dispensed. The pump displays its calculated dose, based on previous calibration data. Use the numeric keys to adjust this reading to match the measured volume. Press **ENTER**. The pump briefly displays the new head, tube and flow settings, and displays the main running screen. Example figures are shown here.

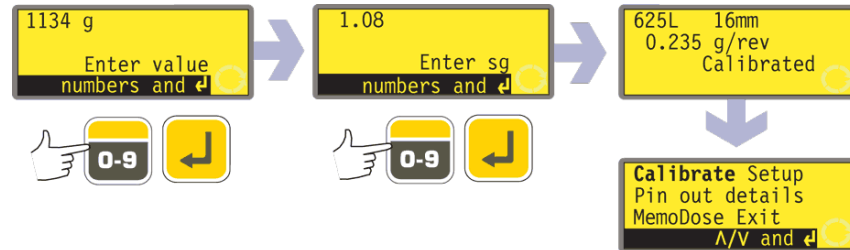

Note: If the pump has been set to display flow rate in units of mass (see 18.8 Flow units), as in this example, the pump displays a screen allowing you to confirm the specific gravity of the duty fluid immediately before the final press on **ENTER**.

Note: if calibration was entered by pressing **CAL (SHIFT, 8)** from the main running screen, **the pump redisplay the main running screen and restarts immediately without waiting for a further command.**

Note: Always recalibrate after changing pump tubes, fluid, or any connecting pipework. It is also recommended that the pump is recalibrated periodically to maintain accuracy.

DuN, Du

18 Setup

Entry to the Setup menu is from the Main menu and can be limited to users who correctly enter a three-digit security code. If a security code has been set, selecting **Setup** and confirming with the **ENTER** key causes the pump to display the Security code entry sequence. See 18.22 Security code. If no security code has been set, the pump displays the first of seven screens containing the Setup menu.

The Setup menu

The Setup menu occupies seven screens. The first two are shown here.

To move from one screen to subsequent screens, repeatedly press DOWN. Each item is highlighted in turn until the last item on the screen is highlighted.

A further press on the DOWN key displays the next screen of the menu, with the first item highlighted.

Follow the reverse procedure using the UP key to move to an item on a previous screen of the menu.

Make a selection using the **UP** or **DOWN** keys and press **ENTER** to confirm your choice.

18.1 Trim

DuN

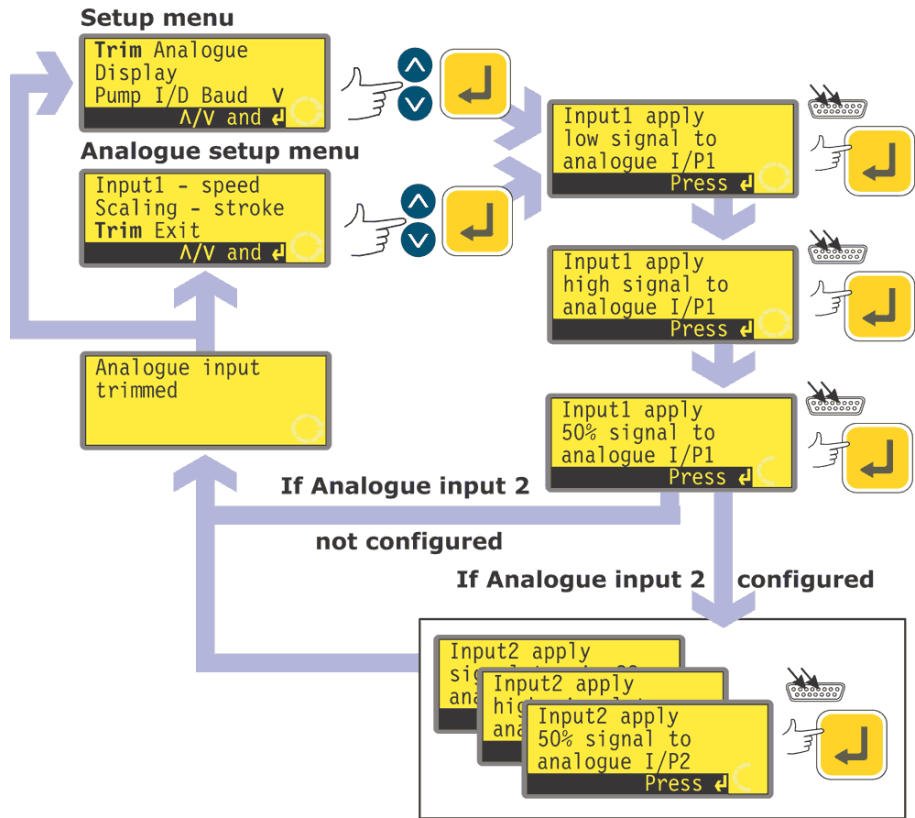

Du

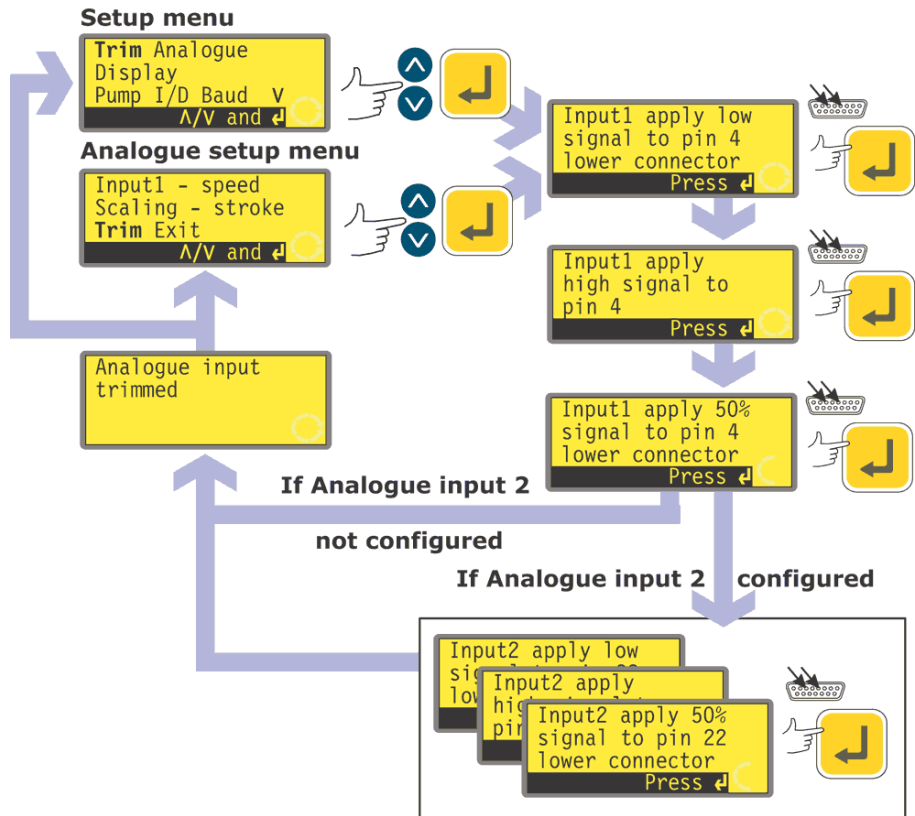

When the pump is under remote control, it tracks an analogue signal from the user's remote control system to the **i/p** terminal of the Analogue 1 and Analogue 2 connectors at the rear of the pump within the ranges 4-20mA, 0-10V or 1-5V. The **Trim** setup sequence allows the user to customise the process-signal-to-pump-speed calibration. The sequence may be entered directly from the Setup menu or from the Analogue setup menu.

- Select **Trim** from the Setup menu or the Analogue setup menu using the **UP** or **DOWN** keys and press **ENTER** to confirm your choice.
- Apply the low process analogue signal to the **i/p** terminal of the Analogue 1 connector as instructed in the display. See 18.2 Analogue. While the signal is being applied, press **ENTER** to record the signal as a calibration point.
- Apply the maximum process control signal. While the signal is being applied, press **ENTER** to record the signal as a calibration point.
- Apply 50% of the maximum process control signal. While the signal is being applied, press **ENTER** to record the signal as a calibration point.
- If a mistake is made, press **STOP** at any point in the sequence, and the pump displays the previous screen.
- The final press on **ENTER** ends the Analogue 1 trimming sequence.
 - If Analogue 2 has been configured, the pump displays a similar sequence of screens for that input. Apply the low, high and mid-range signal to the i/p terminal of the Analogue 2 connector as instructed in the display, pressing **ENTER** each time to record the signals as calibration points.
 - If a mistake is made, press **STOP** at any point in the sequence, and the pump displays the previous screen.
 - The final press on **ENTER** ends the Analogue 2 trimming sequence.
- When trimming is complete the pump displays a confirmation screen and redisplay the screen from which it entered the trim sequence: the Setup menu or the Analogue setup menu.

The pump calculates linear responses from low to mid and from mid to high, and records the results as new analogue input calibration graphs.

If any of the three signals applied to each input match, a warning screen is displayed before the confirmation screen appears, and the trim is ignored.

Note: By applying the maximum process control signal when the minimum is requested and vice versa, inverted responses can be set up.

Note: Resetting factory defaults clears the trim calibration values.

18.2 Analogue

When the pump is under remote control, it tracks an analogue signal from the user's remote control system to the **i/p** terminal of the Analogue 1 connector at the rear of the pump within the ranges 4-20mA, 0-10V or 1-5V. The **Analogue** option in the Setup menu allows the user to configure the pump to operate with his remote control system.

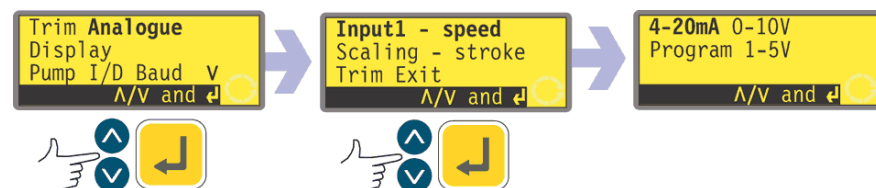

- Select **Analogue** from the Setup menu using the **UP** or **DOWN** keys and press **ENTER** to confirm your choice.
- Four options are displayed: **Input 1 - speed, Scaling - stroke, Trim** and **Exit**.

Input 1 - speed allows the user to tell the pump which signal type he will apply to Analogue 1, or to choose the program option. If he selects **Program** from the subsequent menu, the user can choose his input type and tell the pump the speeds at which to operate on receiving a low or high process control signal. See 18.2.1 Input 1 - speed.

Scaling - stroke allows the user to disable scaling control, or if he wishes to enable scaling, to tell the pump which signal type he will apply to Analogue 2, or to choose the program option. If he selects **Program** from the subsequent menu, the user can choose his input type and tell the pump the speed proportion at which to operate on receiving a low or high process control signal. See 18.2.1 Input 1 - speed.

Trim displays the Trim menu, described above. See 18.1 Trim.

Exit returns the user to the first section of the Setup menu. See 18 Setup.

18.2.1 Input 1: speed

- Select **Input 1 - speed** using the **UP** or **DOWN** keys and press **ENTER** to confirm your choice.
- The pump offers three further choices: **4-20mA**, **0-10V** and **1-5V**. Use the **UP** or **DOWN** keys to make a selection and press **ENTER** to confirm your decision.

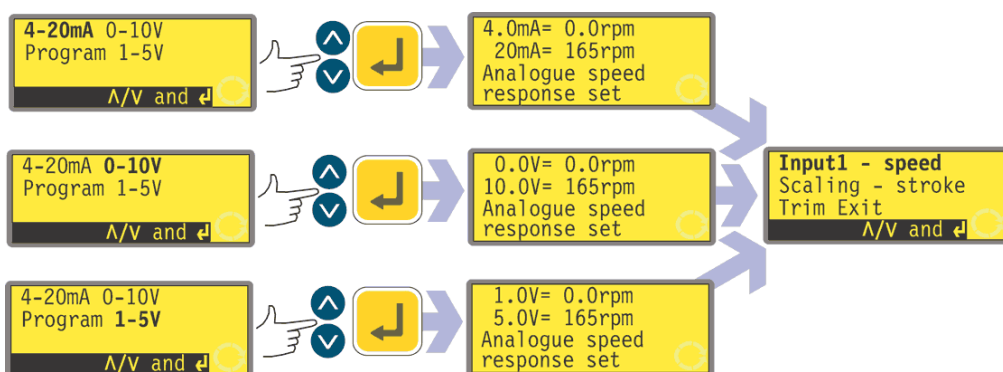

- The pump configures the hardware and factory-set response data and briefly displays a confirmation screen. The user is returned to the Analogue setup display. Example figures are shown here.
- Alternatively the user can select **Program** to configure the pump to respond in a user-programmed way to any process signal range within 4-20mA, 0-10V or 1-5V.

Program

- Select Program using the **UP** or **DOWN** keys and press **ENTER** to confirm.
- The pump offers two choices: **mA** and **V** (0-10V). Use the **UP** or **DOWN** keys to make a selection and press **ENTER** to confirm your decision.

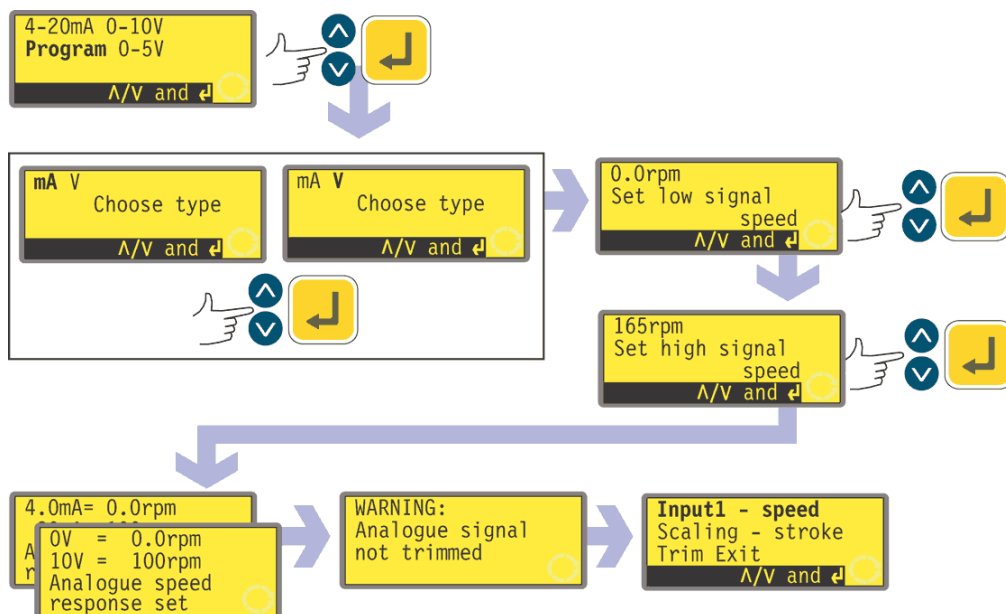

- The pump displays a screen allowing you to set the speed for low signal input (4mA or 0V). Use the **UP** and **DOWN** keys to scroll the display to your chosen speed and press **ENTER** to confirm the figure.
- The pump displays a screen allowing you to set the speed for high signal input (20mA or 10V). Use the **UP** and **DOWN** keys to scroll the display to your chosen speed and press **ENTER** to confirm the figure.
- If a mistake is made, the user may press **STOP** at any point in the sequence (before pressing **ENTER** on the high signal speed screen), and the pump displays the previous screen.
- The final press on **ENTER** causes the pump to configure the hardware and programmed response data. It briefly displays a confirmation screen and a warning that the analogue signal is not trimmed, and returns the user to the Analogue setup menu. Example values are shown here.

18.2.2 Scaling - stroke

- Select **Scaling - stroke** using the **UP** or **DOWN** keys and press **ENTER** to confirm your choice.
- The pump offers six further choices: **Off**, **Keypad**, **4-20mA**, **0-10V**, **1-5V** and **Program**. Use the **UP** or **DOWN** keys to make a selection and press **ENTER** to confirm your decision.
- If **Off** is selected, scaling control is disabled and the pump displays the Analogue setup menu.
- The other options allow a choice of inputs to control scaling.
 - If **Keypad** is selected, scaling will be controlled by entering the scaling factor using the **UP** and **DOWN** keys while the pump is running in Auto analogue mode. See 18.2 Analogue. The pump displays the Analogue setup menu.
 - If **4-20mA**, **0-10V** or **1-5V** is selected, the pump configures the hardware and calibration data appropriately. A confirmation screen is displayed briefly and the user is returned to the Analogue setup menu.
 - If **Program** is selected, the pump offers: **mA** (4-20mA) and **V** (0-10V). Use

the **UP** or **DOWN** keys to make a selection and press **ENTER** to confirm your decision.

- The pump displays a screen inviting the user to enter the required speed proportion for low signal input (4mA or 0V) as a value from 0% to 100%. Enter your value using the **UP** or **DOWN** keys and confirm by pressing **ENTER**.
- A similar screen allows the user to enter the required speed proportion for high signal input (20mA or 10V) as a value from 0% to 100%. Enter the value in the same way.
- If **STOP** is pressed at any point in the program setup (before pressing **ENTER** on the high signal speed proportion screen), the pump displays the previous screen.
- When high and low values have been entered and confirmed, the pump configures the hardware and basic calibration data. A confirmation screen is displayed briefly, followed by a warning that the analogue signal has not been trimmed. The user is returned to the Analogue setup screen.

See 22.4 Scaling: analogue input 2 in Automatic control wiring.

18.2.3 Trim

Trim displays the Trim menu, described above. See 18.1 Trim. It is recommended that a trim calibration is always performed to align the pump's response to the actual process analogue signal.

18.2.4 Exit

Exit returns the user to the first section of the Setup menu, described above. See 18 Setup.

18.3 Display

The pump can display three default screens in manual mode: revolutions per minute, flowrate in a choice of units, or both.

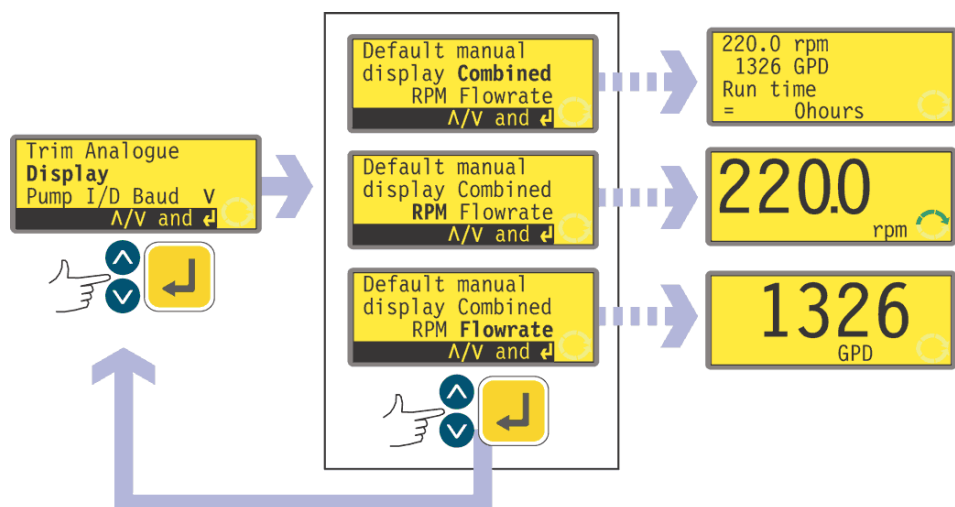

- In the first screen of the Setup menu select **Display** using the **UP** and **DOWN**

- keys. Press **ENTER** to confirm your choice.
- The pump displays a screen allowing you to choose the format of the manual mode main screen. Use the **UP** and **DOWN** keys to choose and press **ENTER** to confirm your decision.
- If you choose **Flowrate** and you have not calibrated the pump since switching it on, a warning screen is displayed for 4 seconds. The warning does not appear if the display screen formats are cycled again, unless the pump has been switched off in the mean time.
- The pump redisplay the first screen of the Setup menu.
- When the pump next runs, the manual mode main screen will display pump activity in rpm, flowrate (in the units you chose - see 18.8 Flow units) or both, according to your choice, plus a run time figure. Examples are shown here.

Alternatively ...

- In the manual mode main screen, repeatedly press **ENTER** to cycle the display between rpm, flowrate (in the units you chose - see 18.8 Flow units) or combined, according to your choice. This cycle operates if the pump is running and if it is stopped. While the pump is running, you can cycle the display in the same way by repeatedly pressing **START**. In both cases, if you have not calibrated the pump since switching it on, a warning screen is displayed for 4 seconds before the flowrate screen appears. The warning does not appear if the display screen formats are cycled again, unless the pump has been switched off.
- The pump redisplay the first screen of the Setup menu.

18.4 Pump I/D

The 620Du pump can be individually controlled under RS232 as one of up to 16 pumps. The 620DuN pump can be individually controlled under RS485 as one of up to 32 pumps. First the pump must be given its identity number.

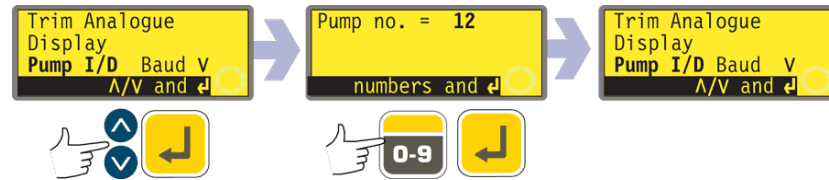

- In the first screen of the Setup menu select **Pump I/D** using the **UP** and **DOWN** keys. Press **ENTER** to confirm your choice.
- The pump displays a screen allowing you to change the pump's identity number. Use the numeric keys to enter a new number in the display and press **ENTER** to confirm your decision. An example is shown here.
- The pump displays the first screen of the Setup menu.

18.5 Baud

The pump can be set to communicate with control devices at a choice of baud rates.



- In the first screen of the Setup menu select **Baud** using the **UP** and **DOWN** keys. Press **ENTER** to confirm your choice.
- The pump displays a screen allowing you to change the pump's baud rate. Use the **UP** and **DOWN** keys to select **1200**, **2400**, **4800** or **9600** (or, 620DuN only, **19k2**) and press **ENTER** to confirm your decision.
- The pump displays the first screen of the Setup menu.

18.6 Stop bits

The pump can be set to communicate with control devices at a choice of stop bits settings.



- In the second screen of the Setup menu select **Stop bits** using the **UP** and **DOWN** keys. Press **ENTER** to confirm your choice.
- The pump displays a screen allowing you to change the pump's stop bits setting. Use the **UP** and **DOWN** keys to select **2**, **1**, or **0** and press **ENTER** to confirm your decision.
- The pump displays the second screen of the Setup menu.

18.7 Xon/Xoff

The pump can be set to communicate with control devices using Xon/Xoff flow control.

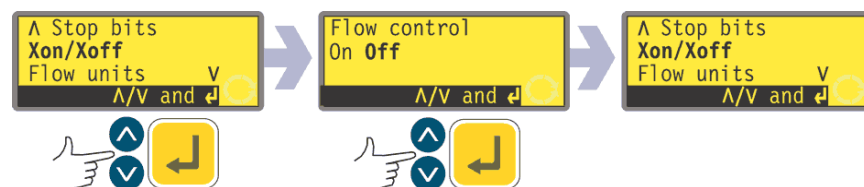

- In the second screen of the Setup menu select **Xon/Xoff** using the **UP** and **DOWN** keys. Press **ENTER** to confirm your choice.
- The pump displays a screen allowing you to set flow control on or off. Use the **UP** and **DOWN** keys to choose and press **ENTER** to confirm your decision.
- The pump displays the second screen of the Setup menu.

18.8 Flow units

The pump can display its flow rate in metric (SI) or US (imperial) units of volume or mass.

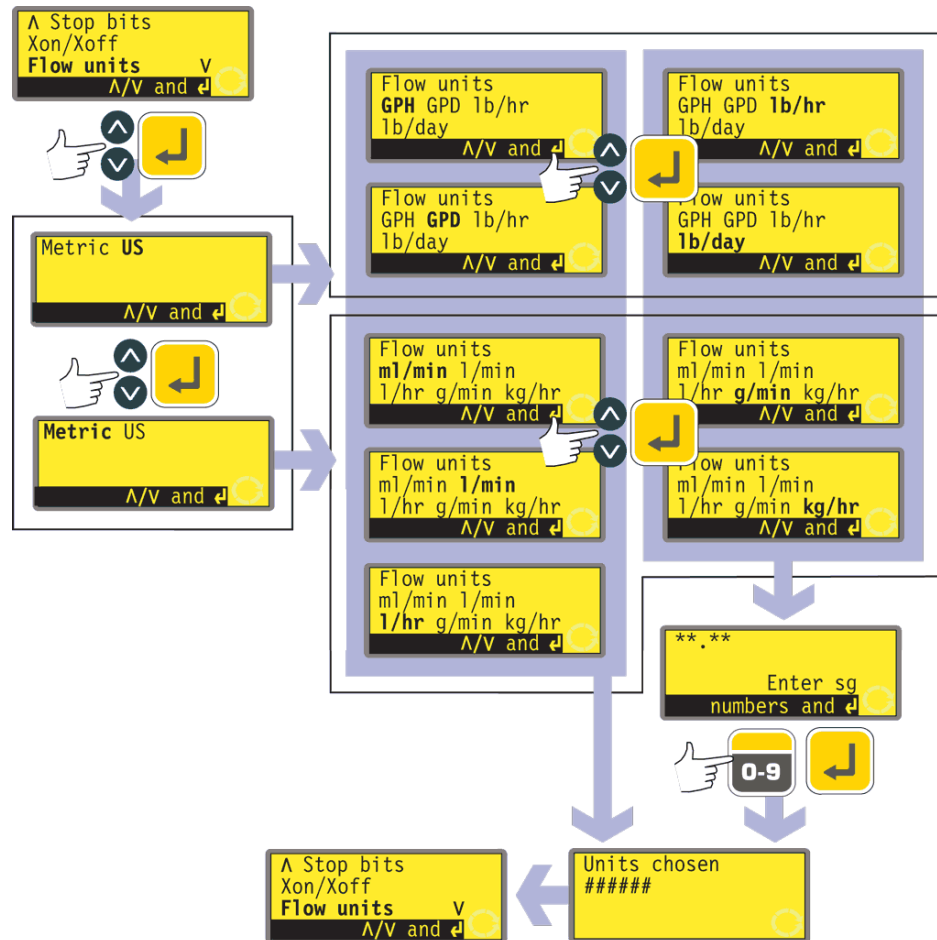

- In the second screen of the Setup menu select **Flow units** using the **UP** and **DOWN** keys. Press **ENTER** to confirm your choice.
- The pump displays a screen offering **Metric** or **US**. Use the **UP** and **DOWN** keys to choose and press **ENTER** to confirm your decision.
- If you chose **Metric**, the pump offers a choice of units: **ml/min**, **l/min**, **l/hr**, **g/min** or **kg/hr**. Use the **UP** and **DOWN** keys to choose and press **ENTER** to confirm your decision.
- If you chose **US**, the pump offers a choice of units: **US Gallons/hr**, **US Gallons/day**, **lb/hr** or **lb/day**. Use the **UP** and **DOWN** keys to choose and press **ENTER** to confirm your decision.
- If you chose a volumetric flow rate from either screen, a confirmation screen appears briefly and the pump displays the second screen of the Setup menu.
- If you chose a mass flow rate from either screen, the pump asks for the specific gravity of the fluid to be pumped. Use the numeric keys to enter a value between 0.01 and 15.00. Press **ENTER** to confirm your decision. Press **STOP** if you decide to make a different choice of units.
- A confirmation screen appears briefly and the pump displays the second screen of the Setup menu.

18.9 Run time

The pump cumulatively records hours of motor operation. The figure can be displayed or reset to zero.

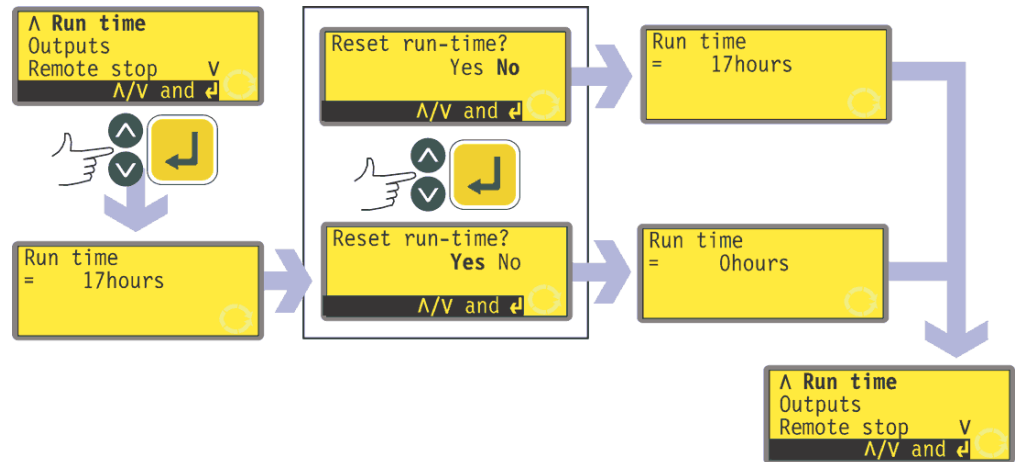

- In the third screen of the Setup menu select **Run time** using the **UP** and **DOWN** keys. Press **ENTER** to confirm your choice.
- The pump briefly displays the total hours its motor has operated since the last time the counter was reset to zero hours, followed by an opportunity to reset the counter to zero hours. An example is shown here. Use the **UP** and **DOWN** keys to choose **Yes** or **No** and press **ENTER** to confirm your decision.
- The total hours screen is displayed with its total reset to zero, or unchanged, as appropriate. The pump displays the third screen of the Setup menu.

Note: Run time is displayed on the Combined display. See 18.3 Display. Run time does not zero when factory default is selected.

18.10 Outputs

DuN

The 620DuN pump offers four relay status outputs. See 12 Switching the pump on for the first time for initial start-up defaults. Each of six parameters can be configured to any output, or more than one output.

Du

The 620Du pump offers four digital status outputs. See 12 Switching the pump on for the first time for initial start-up defaults. Each of six parameters can be configured to any output, or more than one output.

DuN, Du

The parameters are:

Run/stop

Provides a status output to indicate whether the pumphead is in a running or stopped condition. When running at 0rpm, the run/stop output indicates running.

Direction

Provides a status output to indicate which direction the pump is set to run in.

Auto / man

Provides a status output to indicate whether the pump is in analogue control mode or manual control mode.

General alarm

Provides an alarm output when any system error condition occurs except: leak detected; analogue signal out of range; analogue over-signal; analogue no signal.

Leak detected

When used with a leak detector, this output provides an alarm when the pump has been automatically switched off following tube failure.

Head

Provides an alarm when the pumphed guard is open. If it is running, the pump will stop.

DuN

Outputs 1-4 are available as single-pole change-over relay contacts: Relay 1, 2, 3 and 4. Connect to the normally open or normally closed contacts of the relay as required and configure the pump's software accordingly. See below in this section.

Note: The maximum rating on the relay contacts of this pump is 30VDC; maximum load 30W.

Du

Output 1 and output 2 are available in two formats:

- From pins 10 and 11, lower D-connector, as 5V TTL signals.
- From pins 10 and 11, upper D-connector, as open collector logic outputs.

Output 3 and output 4 provide open collector logic outputs from pins 13 and 12, upper D-connector, respectively.

A supply voltage from the pump (5V, 10V, 12V) or user-supplied up to 30V to pin 22, upper D-connector, provides the voltage level for these logic status outputs.

DuN, Du

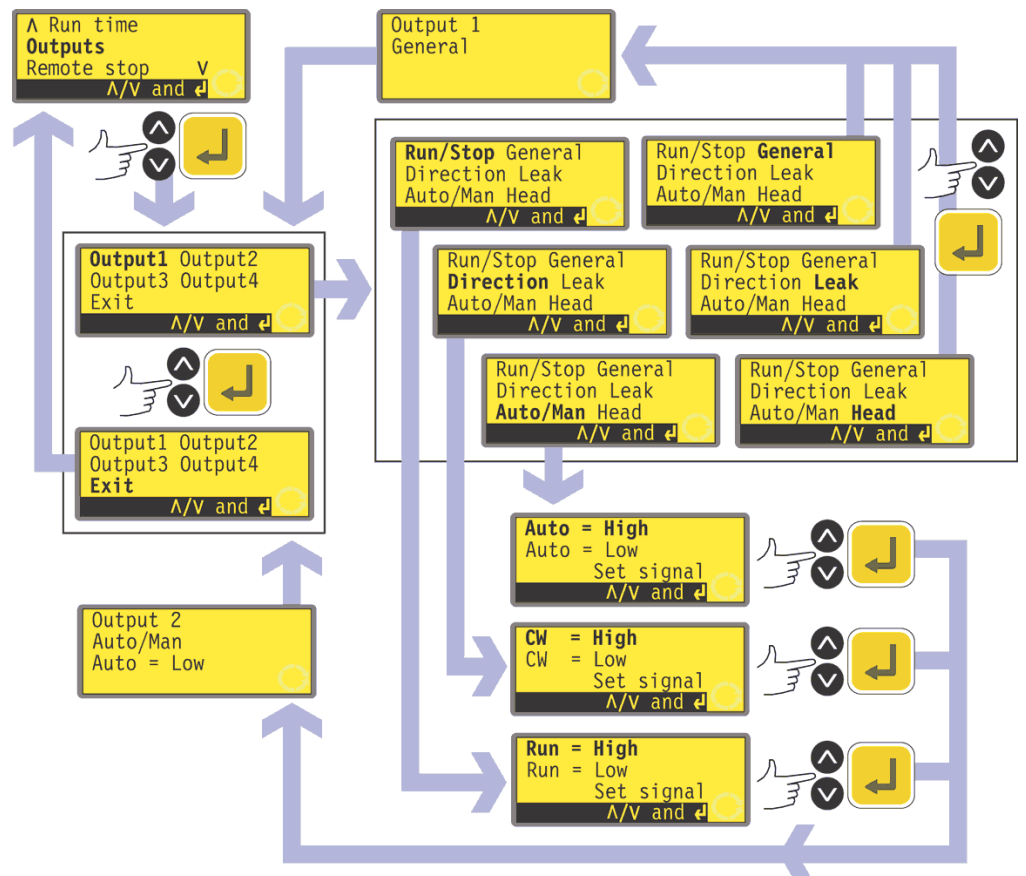

- In the third screen of the Setup menu select **Outputs** using the **UP** and **DOWN** keys. Press **ENTER** to confirm your choice.
- The pump displays a screen allowing you to configure each of the four outputs, or to exit this menu. Use the **UP** and **DOWN** keys to choose and press **ENTER** to confirm your decision.
- If **Output 1** is chosen, the pump displays the six options.
 - Selecting **General, Leak** or **Head** using the **UP** and **DOWN** keys and confirming the choice by pressing **ENTER** configures that option to Output 1, displays a confirmation screen, and returns the user to the Output selection screen.
 - Selecting **Run/Stop, Direction** or **Auto/Man** using the **UP** and **DOWN** keys and confirming the choice by pressing **ENTER** displays screens allowing the user to configure Run to **High** or **Low**, Clockwise to **High** or **Low**, and Auto to **High** or **Low** respectively. Choose using the **UP** and **DOWN** keys and press **ENTER** to confirm. The option chosen is configured to Output 1. The pump displays a confirmation screen, and returns the user to the Output selection screen.
- The user can configure **Output 2, Output 3** and **Output 4** in the same way, or choose **Exit**.
- If **STOP** is pressed during configuration, the previous setting for the output is retained and the pump redisplay the Output selection screen.
- If **Exit** is chosen, the pump returns the user to the third screen of the Setup menu.

18.11 Remote stop

DuN

The 620DuN pump can be stopped and started with a remote switch between the 5V terminal and the i/p terminal of the Run/stop input, using an open=run or open=stop command sense. It also operates with a logic input between 5V and 24V on the i/p terminal of the Run/stop input. If remote switching is disabled, neither the remote run/stop nor direction signal inputs will affect the pump state.

Du

The 620Du pump can be stopped and started with a remote switch between pin 7 and pin 19 using an open=run or open=stop command sense. It also operates with a logic input between 5V and 24V on pin 7. If remote switching is disabled, neither the remote run/stop nor direction signal inputs will affect the pump state.

DuN, Du

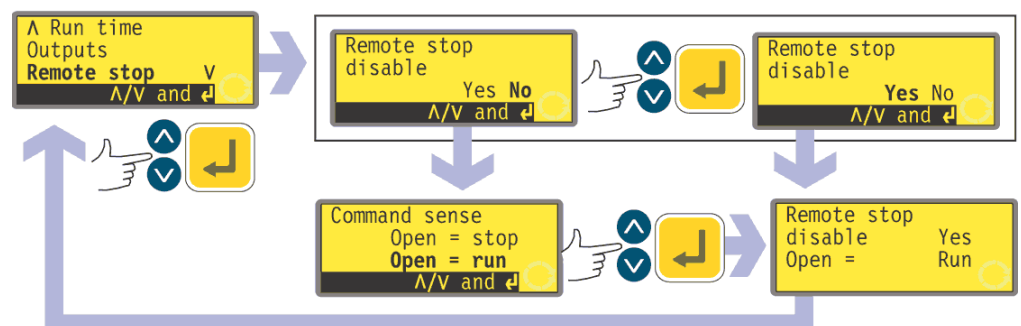

- In the third screen of the Setup menu select **Remote stop** using the **UP** and **DOWN** keys. Press **ENTER** to confirm your choice.
- The pump displays a screen allowing the user to disable the remote stop feature. Use the **UP** and **DOWN** keys to choose **Yes** or **No** and press **ENTER** to confirm the decision.
- If **No** is chosen, the pump asks the user to make a further choice, according to whether the pump is required to run on an open or closed remote switch: **Open=stop** or **Open=run**. Choose using the **UP** and **DOWN** keys and press

ENTER to confirm. The pump briefly displays a confirmation screen and returns the user to the third screen of the Setup menu.

- If **Yes** is chosen, the pump briefly displays a confirmation screen and returns the user to the third screen of the Setup menu. Example screens are shown here.
- **Note:** The confirmation screen indicates whether Remote stop is enabled or disabled, and displays the command sense of the remote control switch **even if Remote stop has been disabled**. This allows the command sense to be displayed if remote switching is disabled.



Even with the remote stop function disabled, the pump could still start if the remote auto/manual toggle input is used to toggle the pump into analogue mode.

18.12 Auto-restart

This pump offers an auto-restart feature. If active on power loss, it restores the pump when power returns to the operating state it was in when power was lost. It does not operate when powering down in the middle of a dose: when the pump is restarted, it will await a press on the **START** key to begin the interrupted dose again. Auto-restart is retained while the pump is switched off. When the pump starts running, look for the ! symbol on the display. This symbol indicates that the pump is set for auto-restart.

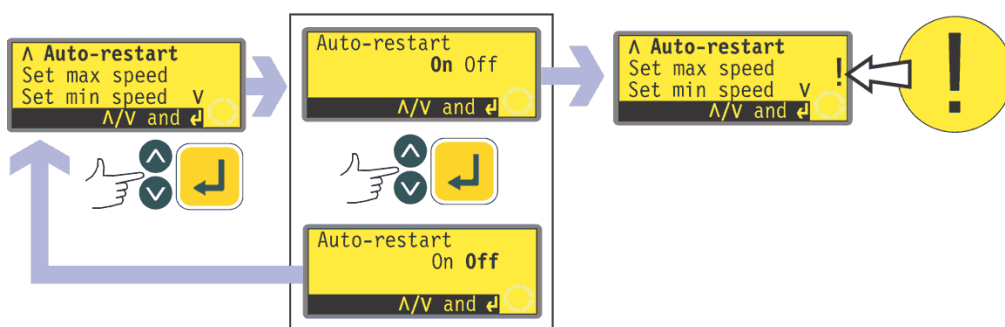

- In the fourth screen of the Setup menu select **Auto-restart** using the **UP** and **DOWN** keys. Press **ENTER** to confirm your choice.
- The pump displays a screen allowing the user to activate auto-restart. Use the **UP** and **DOWN** keys to choose **On** or **Off** and press **ENTER** to confirm the decision.
- If **Off** is chosen, the pump returns the user to the fourth screen of the Setup menu. The auto-restart facility will not operate.
- If **On** is chosen, the pump returns the user to the fourth screen of the Setup menu, where an exclamation mark (!) is now visible. This mark confirms that the auto-restart feature is in place and will operate the next time power is lost and restored.

Alternatively ...

- Stop the pump. Turn off the mains power switch at the rear of the pump.
- Hold down the **START** key and turn on the mains power switch. The ! symbol shows on the display.
- Start the pump. If the mains supply is interrupted the pump will automatically restart when the mains power returns.
- To remove auto-restart switch off the mains power at the rear of the pump. Hold down the **STOP** key and turn the mains power switch on. The ! symbol does not appear.



Do not use auto-restart for more than 100 starts per hour. We recommend remote control where a high number of starts is required.

18.13 Set maximum allowed speed

The maximum allowed speed of the drive defaults to 165rpm. It is possible to set this limit at any speed down to 1rpm as long as the minimum allowed speed is at least 1rpm less, or up to 265rpm; however, see 8.1 Pressure capability for use above 165rpm.

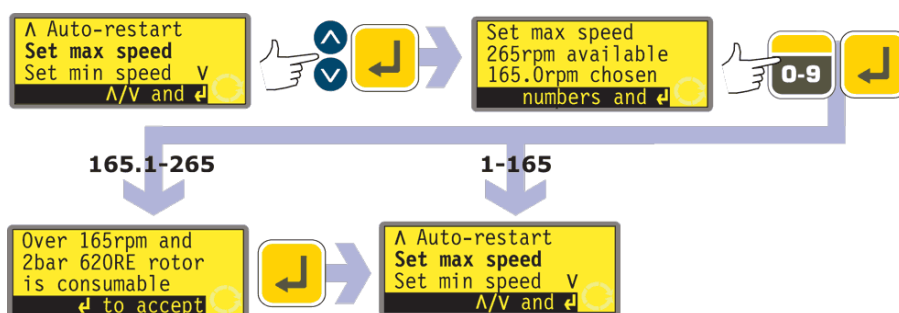

- In the fourth screen of the Setup menu select **Set max speed** using the **UP** and **DOWN** keys. Press **ENTER** to confirm your choice.
- The pump displays a screen allowing the user to set the maximum speed of the pump equal to or lower than the maximum available. Use the numeric keys to set the maximum allowed speed and press **ENTER** to confirm the figure.
- The pump returns the user to the fourth screen of the Setup menu, via a warning screen requiring the user to press **ENTER** if he selected a speed greater than 165rpm.

18.14 Set minimum allowed speed

The minimum allowed speed of the drive defaults to 0.1rpm. It is possible to set this limit at any speed up to 264rpm, as long as the maximum speed is at least 1rpm greater.



- In the fourth screen of the Setup menu select **Set min speed** using the **UP**

- and **DOWN** keys. Press **ENTER** to confirm your choice.
- The pump displays a screen allowing the user to set the minimum speed of the pump equal to or higher than the minimum available. Use the numeric keys to set the minimum allowed speed and press **ENTER** to confirm the figure.
- The pump returns the user to the fourth screen of the Setup menu.

18.15 Scrolling

The pump's speed can be set, up to the maximum allowed speed and down to the minimum allowed speed, by pressing the numeric keys or by using the **UP** and **DOWN** keys.

The numeric keys allow the user to select a speed in increments of one-tenth of a revolution per minute (or the equivalent in flow rate if the pump has been configured to display its performance in units of flow).

The **UP** and **DOWN** keys allow the speed to be set in increments of the user's choice: one-tenth of a revolution per minute; one half of a revolution per minute; one, two, five or ten revolutions per minute (or their equivalents in flow rate if the pump has been configured to display its performance in units of flow). Each press on **UP**, for example, offers a speed one increment greater than the current speed.

Note: For 0.1rpm, 0.5rpm and 1rpm settings, the increments increase progressively as long as the **UP** or **DOWN** key is continually held down.



- In the fifth screen of the Setup menu select **Scrolling** using the **UP** and **DOWN** keys. Press **ENTER** to confirm your choice.
- The pump displays a screen allowing the user to set the **UP** and **DOWN** keys' scrolling increment. Use the **UP** and **DOWN** keys to choose **0.1**, **0.5**, **1.0**, **2.0**, **5.0** or **10.0**. Press **ENTER** to confirm your choice.
- The pump returns the user to the fifth screen of the Setup menu.

Note: If the maximum allowed speed has been set to a figure which is not a multiple of the chosen increment, the last active press on **UP** raises the speed to that maximum rather than to the next multiple of the chosen increment. Similarly, if the pump is running at a speed which is not a multiple of the chosen increment, the first press on **UP** raises the speed to the next multiple of the chosen increment.

18.16 Date and time

The pump's real-time clock can be set with the date and time.

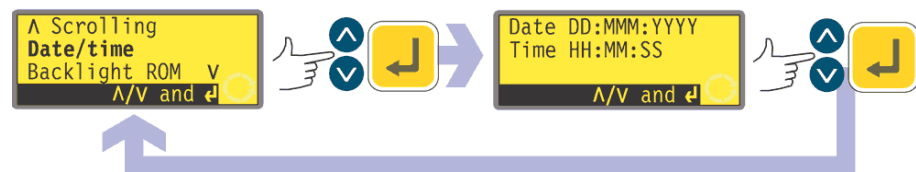

- In the fifth screen of the Setup menu select **Date/time** using the **UP** and **DOWN** keys. Press **ENTER** to confirm your choice. The pump displays any pre-

vious setting.

- If the setting displayed is correct, press **ENTER**. The pump redisplay the fifth screen of the Setup menu.
- If you wish to change the setting, use the **UP** and **DOWN** keys to enter the current date (two digits), month (three letters), year (four digits), hour, minute and second (all two digits), pressing **ENTER** to confirm each one.
- When **ENTER** is pressed to confirm the seconds, the pump redisplay the fifth screen of the Setup menu.

18.17 Backlight

The pump's display can be illuminated or not according to choice.

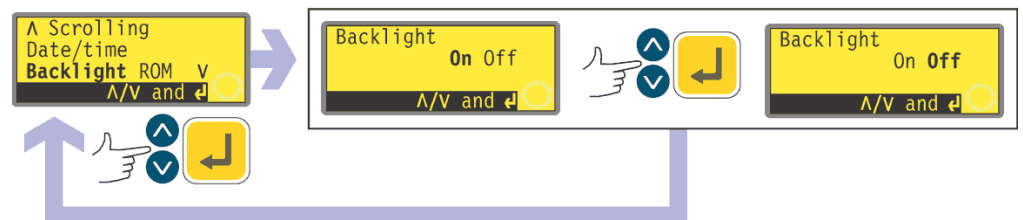

- In the fifth screen of the Setup menu select **Backlight** using the **UP** and **DOWN** keys. Press **ENTER** to confirm your choice.
- The pump displays a screen allowing the user to switch the display backlight on or off. Use the **UP** and **DOWN** keys to choose **On** or **Off** and press **ENTER** to confirm the decision.
- The pump returns the user to the fifth screen of the Setup menu. The display is now illuminated or not according to the user's decision.

Alternatively ...

- To turn the backlight off: press **STOP** and **DOWN** together.
- To turn the backlight on: press **STOP** and **UP** together.

18.18 ROM

The pump can display its software version, model number and pump speed.



- In the fifth screen of the Setup menu select **ROM** using the UP and **DOWN** keys. Press **ENTER** to confirm your choice.
- The pump displays the software version, model number and the maximum allowed pump speed for four seconds (an example is shown here), then returns the user to the fourth screen of the Setup menu. It also displays a checksum: CHK 123, for example. This may be required if reporting pump performance to the Watson-Marlow service department.

Alternatively ...

Press **1 (DIRECTION)** and **DOWN** together to interrupt the display and show the pump's ROM version for four seconds.

18.19 Language

The pump can be set to operate in several languages.



- In the sixth screen of the Setup menu select **Language** using the **UP** and **DOWN** keys. Press **ENTER** to confirm your choice.
- In the next screen, choose a language using the **UP** and **DOWN** keys. Press **ENTER** to confirm your choice. The pump redisplayes the sixth Setup screen in your chosen language. All screens will subsequently appear in your chosen language.

18.20 Defaults

All the pump's user-set data can be reset to factory defaults.

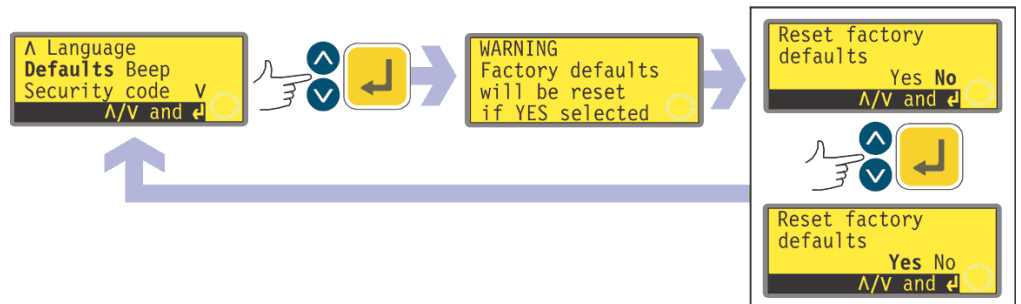

- In the sixth screen of the Setup menu select **Defaults** using the **UP** and **DOWN** keys. Press **ENTER** to confirm your choice.
- A warning is displayed for four seconds, and the pump asks the user to confirm that factory defaults are to be reset. Use the **UP** and **DOWN** keys to choose **Yes** if you wish the pump to reset all user-set data back to factory defaults (see 12 Switching the pump on for the first time); or **No** if you do not wish to do this. Press **ENTER** to confirm your decision. If **Yes** was chosen, the pump resets its factory defaults and redisplayes the sixth Setup screen. If **No** was chosen, the pump makes no changes to its setup and redisplayes the sixth Setup screen.

18.21 Beep

The pump keypad can operate silently or indicate a positive key-press with a beep sound.

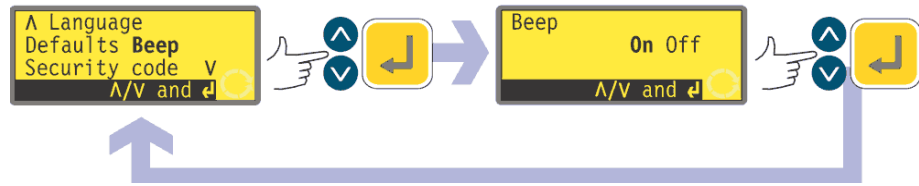

- In the sixth screen of the Setup menu select **Beep** using the **UP** and **DOWN** keys. Press **ENTER** to confirm your choice.
- In the next screen, use the **UP** and **DOWN** keys to choose **On** or **Off**. Press **ENTER** to confirm your decision. The pump redisplayes the sixth Setup screen.

Alternatively ...

- To toggle the sound on and off, stop the pump. Turn off the mains power switch at the rear of the pump.
- Depress the **UP** and **1 (DIRECTION)** keys while switching on the mains power switch at the rear of the pump.

18.22 Security code

Access to the pump's Setup and Calibration menus, direction control and keypad lock can be restricted to those who correctly enter a three-digit security code: the main code. A secondary user code can be set, which permits PIN access to calibration, direction and keypad lock, but blocks access to Setup. See 18 Setup, 17 Calibrate, 14.3 Direction and 14.4 Keypad lock.

The codes must first be set.

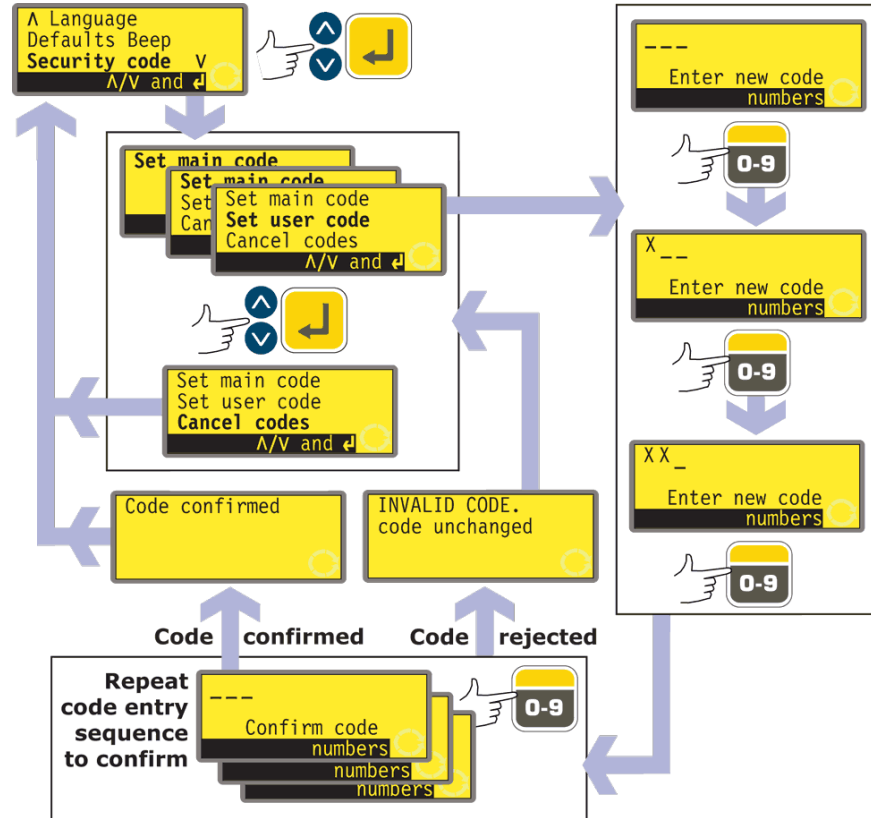

- In the sixth screen of the Setup menu select **Security code** using the **UP** and **DOWN** keys. Press **ENTER** to confirm your choice.
- If no code has been set, a screen is displayed inviting the user to set a main code. Press **ENTER** to proceed (or **STOP** to return to the sixth screen of the Setup menu).
- If a main code has been set, a screen is displayed inviting the user to set a new main code, to set a user code (or a new user code if one has already been set), or to cancel all codes. Choose **Set main code**, **Set user code** or **Cancel codes** using the **UP** and **DOWN** keys. Press **ENTER** to confirm your choice.
- If you chose **Cancel codes**, any codes previously set are cancelled and access to the pump is not restricted.
- If you chose **Set main code** or **Set user code**, the pump displays a screen with three blank spaces for digits and the instruction "Enter new code". Use the numeric keys to enter three digits. The pump displays a similar three-digit entry screen and the instruction "Confirm code".
- Repeat the digit-entry sequence.
- If the second three-digit code entered differs from the first, or if the digits chosen as a user code are the same as those already set as a main code, the pump briefly displays an error message and redisplay the set code options screen.
- If the codes tally and, for a user code, if there is no clash with a previously set

main code, the pump briefly displays a confirmation message and redisplay the sixth Setup screen. Access to the Setup and Configuration menus, direction control and keypad lock is now protected by the new security code.

- If **STOP** is pressed during code entry, the pump returns the user to the sixth Setup screen. If **STOP** is pressed during code confirmation, the pump returns the user to the first digit-entry screen.

Note: A user code cannot be set unless a main code has previously been set. If you wish to cancel only a user code, you must use **Cancel codes** to cancel both user and main codes, then use **Set main code** to set a new main code.

Note: If a code has been set but forgotten, it is still possible to access the Setup screens to cancel the code or reset it to another three-digit number. Contact your supplier or Watson-Marlow Technical support for the bypass sequence.

18.23 Exit



- In the seventh screen of the Setup menu **Exit** is highlighted. Press **ENTER**.
- The user is returned to the main menu.

Du

19 Pin out details

Selecting **Pin out details** from the main menu causes the pump to display an information screen and then its preset pin and voltage details under 18 headings: **Analogue input 1, Analogue input 2, Analogue output, Tacho output, Direction enable, Direction input, Run/Stop input, Leak input, Auto/Man toggle, Dose input, Output 1, Output 2, Output 3, Output 4, Supply, 0 volts, Earth** and **Others**. No user input is available in this section; it displays information only.

In the main menu, select **Pin out details** using the **UP** or **DOWN** keys and press **ENTER** to confirm your choice.

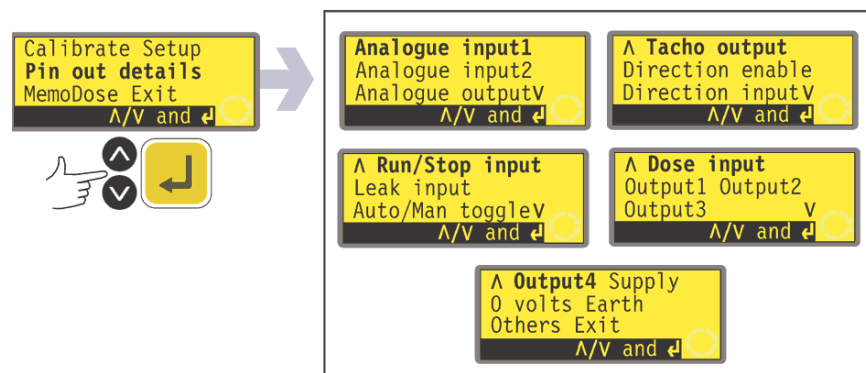

The Pin out details menu

The Pin out details menu occupies five screens. The first two are shown here.

To move from one screen to subsequent screens, repeatedly press **DOWN**. Each item is highlighted in turn until the last item on the screen is highlighted. A further press on the **DOWN** key displays the next screen of the menu, with the first item highlighted.

Follow the reverse procedure using the **UP** key to move to an item on a previous screen of the menu.

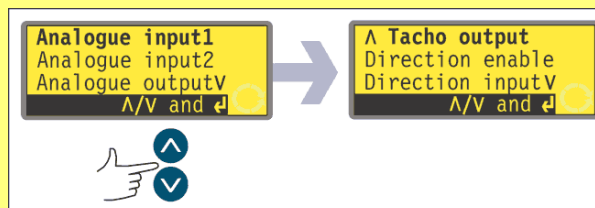

Make a selection using the **UP** or **DOWN** keys and press **ENTER** to confirm your choice.

The information on pin outs duplicates the details described in this instruction manual under Automatic control wiring.

The screens available are all presented in a similar manner. For example, on selecting **Analogue input 1**, the following screen is displayed:

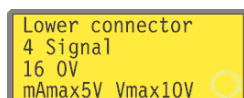

This indicates that the analogue input signal must be applied to pin 4 of the lower D-connector at the rear of the pump, where 0 volts is available on pin 16. If the analogue input is configured for a 4-20mA signal, the maximum permitted voltage is 5 volts across the pump; if the analogue input is configured for a 0-10V or 1-5V signal, the maximum permitted voltage is 10 volts.

The information available on selecting **Supply** and **Others** is presented on two screens each. Pressing **DOWN** when the first screen of each is displayed causes the second screen to appear. **UP** performs a similar function.

Pressing **STOP** or **ENTER** in any Pin out information screen returns the user to the appropriate Pin out menu screen.

To leave the Pin out menu screens

Cycle through the Pin out menu screens until the fifth screen is displayed. Select **Exit** using the **UP** or **DOWN** keys and press **ENTER** to confirm your choice.

Alternatively ...

Repeatedly press **STOP** to go back level by level until the main menu is displayed.

20 MemoDose

Each time the pump is started by pressing **START**, it records the number of pump-head revolutions which occur until **STOP** is pressed. The number of revolutions is proportional to the volume of fluid which has been dispensed: the dose. The MemoDose facility allows the user to repeat-dose a precise volume of fluid. To do so, a quantity of fluid must be dispensed as the master dose which the MemoDose facility can repeat exactly or proportionately.

To dispense a master dose

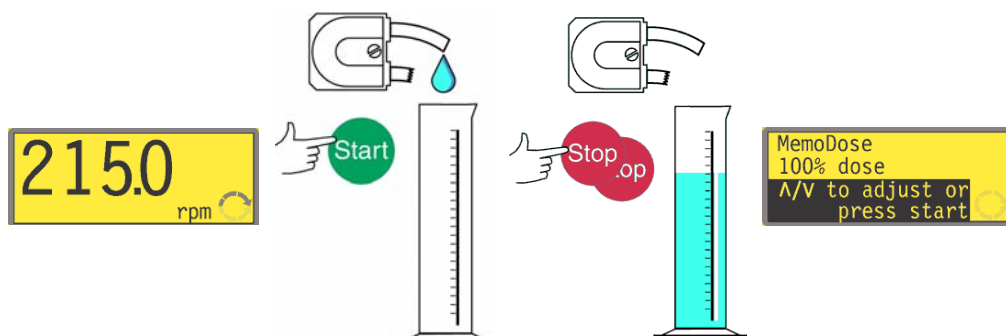

- In the manual mode main screen, set the appropriate pump speed and direction using the **UP** or **DOWN** keys and the **DIRECTION (SHIFT, 1)** key. An example is shown here. A slower speed may make it easier for the user to measure accurately - though it may not represent the duty condition.
- Place a suitable measuring vessel under the pump delivery tube.
- Press **START**. The pump runs and fluid is pumped into the vessel.
- When the required volume of fluid has been dispensed, it is necessary to stop the pump and display the MemoDose screen. This can be achieved in three ways.
 - 1 Press the **STOP** key twice within half a second. The pump stops and immediately displays the MemoDose screen.
OR...
 - 2 Press the **STOP** key once. The pump stops. (This may make it easier to ensure that the quantity of fluid that has been dispensed is sufficiently precise.) Then press the **STOP** key twice within half a second. The pump displays the MemoDose screen.
OR ...
 - 3 Press the **STOP** key. The pump stops. Press the **MENU (SHIFT, 7)** key. Use the **UP** or **DOWN** keys to select **MemoDose**. Press **ENTER** to confirm. The pump displays the MemoDose screen.

To repeat the dose

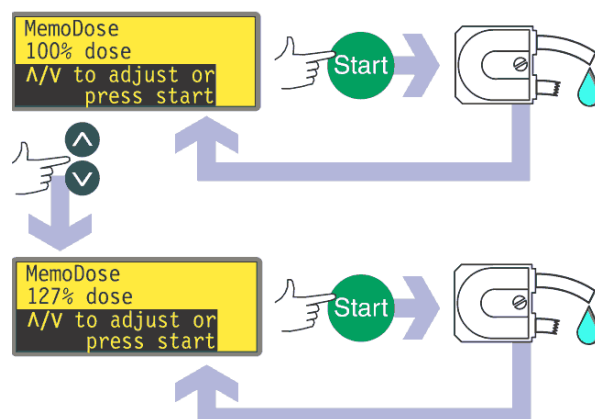

- The pump has recorded the number of pumphead revolutions required to dispense the master dose. If the volume of fluid in the measuring vessel is the volume required, press **START** to repeat the dose.
- If the volume of fluid in the measuring vessel differs from the volume required, the percentage may be adjusted within the limits 1% to 999% of the master dose. Use the **UP** or **DOWN** keys to alter the percentage. Press **START** to dispense the new dose.
- The display counts down as the dose proceeds and stops when the dose is complete.
- If **STOP** is pressed during dosing, the pump stops and returns the user to the MemoDose percentage screen.

Press the **STOP** key twice within half a second if you wish to exit MemoDose and return to manual operation.

20.1 Changing dosing speed

The user must exit MemoDose in order to change pump speed. After returning to MemoDose, the pump dispenses the previous dose size at the new speed.

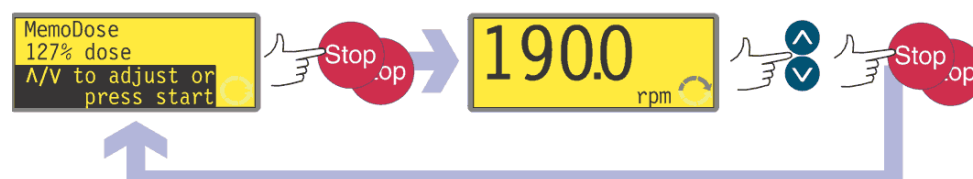

- Press the **STOP** key twice within half a second. The pump displays the manual mode main screen.
- **Do not start the pump. Doing so erases the previously recorded master dose and replaces it in the pump's memory with the current, unmeasured dose.** Adjust the speed showing on the display using the **UP** or **DOWN** keys.
- Press the **STOP** key twice within half a second to return to MemoDose. The display shows the previous percentage dose size. The pump will dose at the new speed.

Note: To retain the MemoDose value through a power interruption the pump must be in auto-restart mode. The dosing cycle will resume at the start of a dose and wait for **START** to be pressed, with the MemoDose percentage screen displayed. See 18.12 Auto-restart.

20.2 Footswitch operation and other remote inputs and outputs with MemoDose

A footswitch can be used to trigger MemoDose dispensing as a hands-free alternative to pressing **START**.

To operate MemoDose with a footswitch, briefly press the footswitch while the MemoDose percentage screen is displayed.

The remote run/stop input is operational. If a dose is interrupted by a remote stop signal, the dose will continue from where it stopped when the state is changed to run.

Remote direction control is disabled. The leak-detection input is operational. All status outputs are operational.

Note: The keypad lock feature is particularly useful to prevent inadvertent dose changes while using the MemoDose facility. Keypad lock continues to operate in MemoDose if previously enabled; it can also be enabled while in MemoDose mode. See 14.4 Keypad lock.

DuN, Du

21 Exit

Press **Exit** in the Main menu to return to the Manual mode main screen.

22 Automatic control wiring using the 620N module

Interfacing the pump with other devices is by means of screw-terminal connectors within the 620N watertight module at the rear of the pump. Suitable cable must be passed into the module through one or more watertight cable glands and connected appropriately. The module must be removed to allow this.



It is important to check that the pump's voltage setting matches the supply. The voltage selection switch is on the rear panel of the drive. The module must be removed (and replaced) to allow it to be checked.

22.1 620N module removal and replacement

To remove the 620N watertight module:

The module is secured to the back of the drive unit by six M5x12 Pozidriv counter-sunk stainless steel screws.

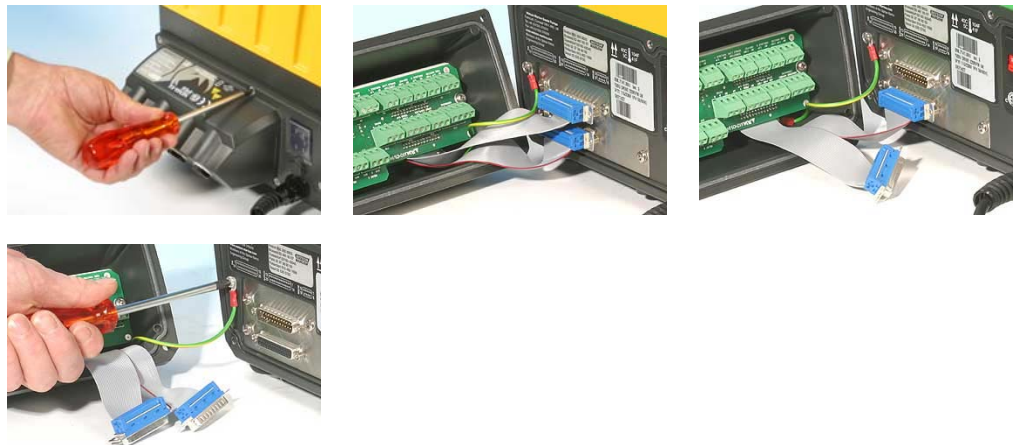

- Remove the six screws using a suitable crosspoint screwdriver, leaving the top centre screw till last. Even when all screws have been removed, the sealing strip may cause the module to adhere to the drive. If so, a gentle tap will free it. Do not use a tool to lever it off.
- The sealing strip should be retained within its channel on the face of the module. The transparent on/off switch cover should be retained on its flange on the face of the module. Check the integrity of the seal and the transparent on/off switch cover. If either is damaged, it must be renewed to maintain ingress protection.
- If necessary, unplug the two 25-way D-connectors linking the module to the pump drive. If necessary, remove the module's earth link from the back of the drive. However, the link is long enough to allow the module to fold back to give access to the circuit board inside and to the back of the drive.

To replace the 620N watertight module:

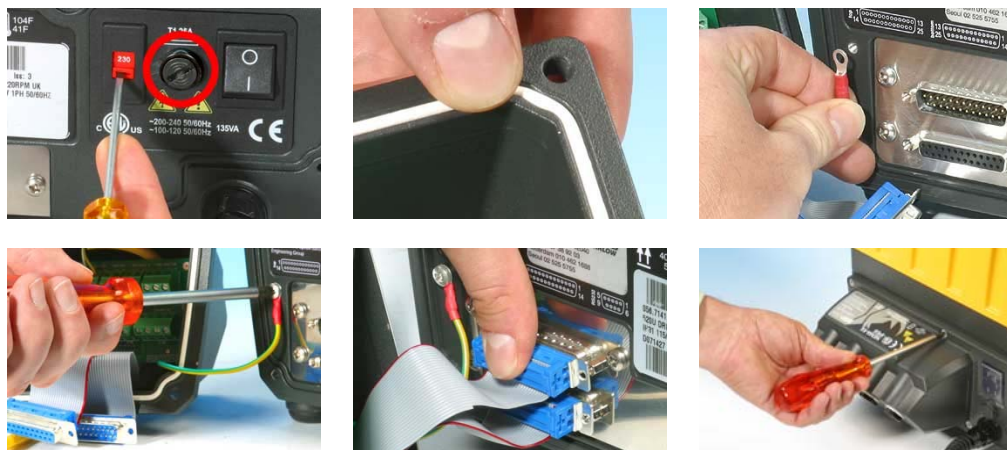

- Check that the fuse in the fuseholder (ringed) does not need to be replaced. Check that the voltage selector switch is correctly set.
- Check that the sealing strip is fully in its channel on the face of the module.
- Attach the module's earth link wire. Replace and tighten its screw to 2Nm.
- Push home the female (upper) and male 25-way D-connectors.
- Hold the module in place. Do not disturb the seal or pinch the earth link wire or D-connector ribbon cables, and screw in the retaining screws (top centre first). Tighten to 2.5Nm.

Note: The 620N module must be properly fitted using all six screws. Without them, the screw holes may corrode and IP66 (NEMA4X) protection will be compromised.

22.2 Wiring up

It is the user's responsibility to ensure the pump's safe and reliable operation under remote and automatic control.

This pump's 0V lines are commoned and mains transformer-isolated from ground (floating ground). It can be connected to isolated 0V or grounded 0V interfaces.

Cable entry to the module is via up to four watertight cable glands. These may be fitted in place of the plugs which seal the module when the pump is shipped.

The number of glands needed depends on the number of connection cables required and the convenience of the installer. As standard, four M16 cable glands are provided with the pump.



Recommended control cables must be used for the terminal blocks: metric = 0.14sq mm - 2.5sq mm solid and 0.14sq mm - 1.5sq mm stranded. USA = 26AWG - 14AWG solid and 26AWG - 16AWG stranded. Cable: circular. Max/min outside diameter to ensure a seal when passed through the standard gland: 9.5mm-5mm. **The cable section must be circular to ensure a seal.**



The recommended cable and cable glands must be used for the IP66 (NEMA 4X) version of this pump; otherwise ingress protection may be jeopardised.

For EMC protection, shielded control cable should be used. The shielding should be terminated to one of the pcb mounting screws or to the adjacent spade connection (where fitted).

For improved EMC protection in extremely noisy environments, shielded cable may be used in conjunction with watertight EMC metal cable glands. These must be earthed to the module by adding an M16x1.5 nut with serrated edges to ensure proper contact with the inside of the module. It is necessary to remove the module's circuit board to access the interior of the module: it is held in place by two fixing screws which can be removed and replaced with a cross-point screwdriver. Take normal anti-static precautions when handling printed circuit boards.

Suitable cables for general-purpose use: 300V with extra premium grade PVC jacket with good flame and moisture resistance.

Suitable cables for industrial use: 300V extra-rugged polyurethane grade jacket with resistance to oils, fuels, solvents and water.

For convenience of wiring more than 8 conductors per cable may be awkward to handle. Only two appear in the illustrations here, for clarity.

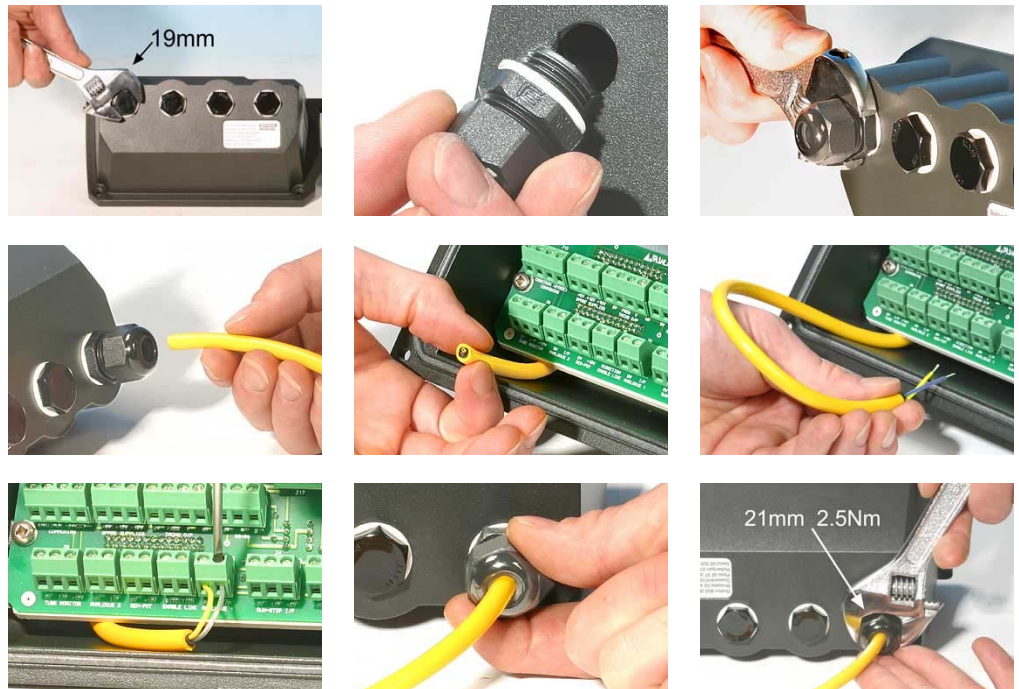

- Use a 19mm spanner to unscrew the sealing plug. Discard the nylon sealing washer.
- Screw in one of the supplied M16x1.5 cable glands in place of the plug, using the new nylon sealing washer supplied. Tighten the gland to 2.5Nm to ensure a seal, using a 21mm spanner. If a different gland is used, it must be watertight to IP66.
- Loosen the gland cap (do not remove it) and pass the cable in through the gland. When it has passed through the gland, continue to push the cable through.
- The inside of the module is shaped to guide the cable past the printed circuit board inside. Continued pushing will feed in enough cable to grip inside the module with the fingers.
- Pull through sufficient cable to reach the connectors required. Leave a little slack.
- Strip the outer sheath as necessary and remove 5mm of insulation from the conductors. No tinning or ferrule is required. Note: If very stiff or large-diameter cable is used, it may be convenient to strip the outer sheath before passing

the cable's conductors through the gland. However, to ensure a seal, cable with an undamaged sheath must be present within the gland when it is tightened.

- Twist a suitable length of the cable screen. Loosen one of the pcb retaining screws and wind the shielding round it. Secure the screen by refastening the screw. Alternatively, secure the cable screen to the adjacent spade connection (where fitted).
- Push the bared conductor into the square hole in the connector. When the conductor is fully in, tighten the retaining screw to hold it in place.
- When all conductors are in position, use a 21mm spanner to tighten the gland cap to 2.5Nm to ensure a seal. Alternatively, tighten the gland by hand until it is finger-tight and use a spanner to tighten it further by one-half a turn.

Do not strap the control and mains power cables together.

620N watertight module pcb connectors:

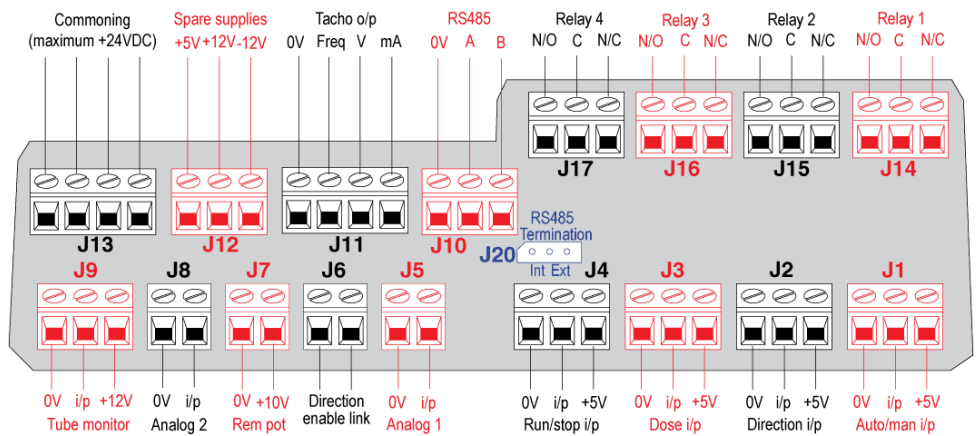

⚠ Never apply mains power to the terminals within the 620N module. Apply the correct signals to the terminals shown below. Limit signals to the maximum values shown. Do not apply voltage across other terminals. Permanent damage, not covered by warranty, may result. The maximum rating on the relay contacts of this pump is 30V DC; maximum load 30W. Note: Also suitable for low power: ie, 1mA at 5VDC minimum.

RS485 settings

Baud	Set in Setup, Baud. Factory default is 9600	Parity	None
Stop bits	2	Handshake	None
Data bits	8	Auto echo	On



Never apply mains voltage to the D-connectors. Apply the correct signals to the pins shown. Limit signals to the maximum values shown. Do not apply voltage across other pins. Permanent damage, not covered by warranty, may result.

22.3 Speed: analogue input

It is possible to control the speed of the pump remotely by one of these methods: a voltage analogue signal within the ranges 0-10V or 1-5V; or a current analogue signal within the range 4-20mA; or a remote potentiometer using the **10V** supply at J7.

The analogue process signal must be applied to the **i/p** terminal of the Analogue 1 connector (J5). Ground to the **0V** terminal of the same connector. The pump will provide an increasing flow rate for a rising control signal (non-inverted response) or an increasing flow rate for a falling control signal (inverted response). See 18.2 Analogue.

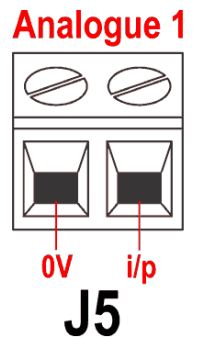

4-20mA circuit impedance: 250Ω.

For voltage modes, a stable, reliable voltage source can be used with a DC voltmeter. Circuit impedance: 22kΩ.

Inverting the response is set up in software. Do not invert the polarity of the terminals.

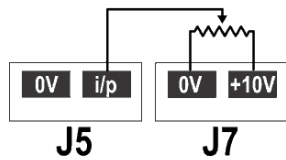

A remote potentiometer with a nominal value of between 1k and 2k with a minimum of 0.25W should be wired between the terminals of the Rem-pot connector (J7) and the **i/p** terminal of the Analogue 1 connector (J5).

When using a remote potentiometer, do not apply a voltage or current control input signal at the same time. The speed control signal will require calibration relative to the minimum and maximum settings of the potentiometer. This is done in software. See 18.1 Trim in the Setup section.

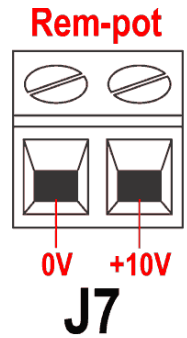

When using a remote potentiometer, it is important to set the analogue input to voltage in the Setup menu. Otherwise the reference voltage supply from the Rem-pot connector will be overloaded and will not provide a full 5V or 10V.

22.4 Scaling: analogue input

It is possible to scale the speed of the pump remotely by one of these methods: a voltage analogue signal within the ranges 0-10V or 1-5V; or a current analogue signal within the range 4-20mA; or a remote potentiometer using the **10V** supply at J7.

The analogue process signal must be applied to the **i/p** terminal of the Analogue 2 connector (J8). Ground to the **0V** terminal of the same connector.

4-20mA circuit impedance: 250Ω.

For voltage modes, a stable, reliable voltage source can be used with a DC voltmeter. Circuit impedance: 22kΩ.

Inverting the response is set up in software. Do not invert the polarity of the terminals.

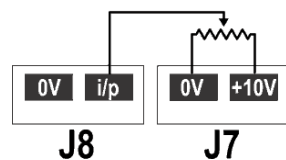

A remote potentiometer with a nominal value of between 1k and 2k with a minimum of 0.25W should be wired between the terminals of the Rem-pot connector (J7) and the **i/p** terminal of the Analogue 2 connector (J8). When

using a remote potentiometer, do not apply a voltage or current control input signal at the same time. The scaling control signal will require calibration relative to the minimum and maximum settings of the potentiometer. This is done in software - see 18.1 Trim in the Setup section.

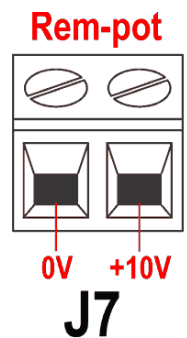
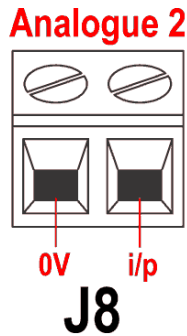

When using a remote potentiometer, it is important to set the analogue input to volt-

age in the Setup menu. Otherwise the reference voltage supply from the Rem-pot connector will be overloaded and will not provide a full 5V or 10V.

The speed of the pump as set by Analogue 1 is scaled in proportion to the signal from Analogue 2 according to the formula $y=as$, where a is the speed set by Analogue 1, s is the scaling set by Analogue 2 (0V or 4mA = 0, increasing linearly to 10V or 20mA = 1), and y is the scaled rotation speed. If Analogue 2 has been set for an inverted response, the reverse is true. See 18.2 Analogue in the Setup menu.

22.5 Speed: analogue output

An analogue voltage output signal is available on the Tacho output connector (J11), between the **V** terminal and the **0V** terminal. The voltage is directly proportional to the pumphead rotation speed. 0V = zero speed; 10V = maximum allowed speed.

A current analogue signal within the range 4-20mA is available between the **mA** terminal and the **0V** terminal. The current is fixed and directly proportional to the pumphead rotation speed. 4mA = zero speed; 20mA = maximum allowed speed.

Note: If the mA output is to be used for reading from a multimeter, a 250Ω resistor is required in series.

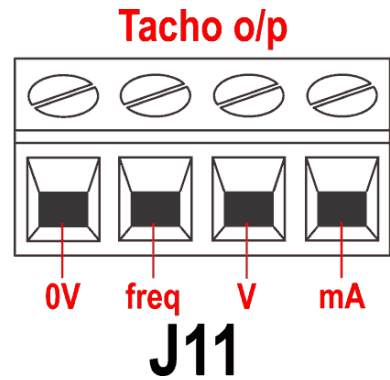

22.6 Tachometer frequency output

A tachometer frequency output is available on the Tacho output connector (J11), between the **freq** terminal and the **0V** terminal. It provides a +5V square wave pulse, maximum 0.5mA, the frequency of which is directly proportional to pumphead rotation speed. It provides 5.578 Hz/rpm - 334 pulses per output shaft revolution. The pulse train from the pump can be used to calculate the speed of rotation or to determine the number of pumphead revolutions. This output has the required strength to be effective up to 3m from the pump. Longer cable runs require signal amplification.

Important: general instructions for remote control inputs

All remote control inputs can be wired in two ways:

Logic

A logic voltage between 5V TTL and 24V industrial logic may be wired to the input. The pump is configured to operate without modification anywhere in this range. Any of the 0V terminals - though preferably the 0V terminal associated with the desired input - is connected to the control device's 0V to make the circuit. Low is equivalent to 0V. High is equivalent to 5V→24V.

Switch

A remote switch may be connected between the input and any positive voltage supply from the pump - though preferably the associated supply terminal. Do not use the 10V supply from the Rem-pot connector, however.

22.7 Run/stop input

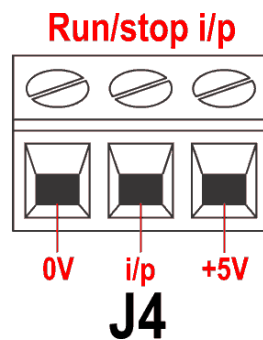

Remote run/stop: connect a remote switch between the **i/p** terminal and the **+5V** terminal of the Run/stop i/p connector (J4). Alternatively a logic input may be applied to the **i/p** terminal, ground to the **0V** terminal. High input stops the pump, low input runs the pump. With no connection or with the switch open, the pump will default to running. To change or set the sense of the run/stop input, see 18.11 Remote stop in the Setup menu.

22.8 Direction input

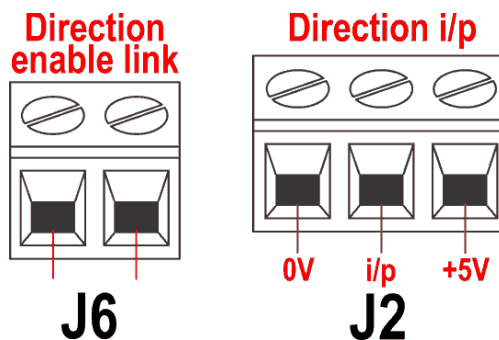

To enable remote direction control and disable the **DIRECTION (SHIFT, 1)** key on the keypad, link the terminals of the Direction enable link connector (J6). **Important: Apply no voltage whatever to the Direction enable link.** Connect a remote switch between the **+5V** terminal and the **i/p** terminal of the Direction i/p connector (J2). Open switch for clockwise rotation, closed switch for counter-clockwise rotation. Alternatively a logic signal may be applied to the **i/p** terminal and the **0V** terminal of the Direction i/p connector (J2). Low input for clockwise rotation, high input for counter-clockwise rotation. With no connection the pump defaults to clockwise rotation.

22.9 Auto / manual toggle input

Connect a remote switch between the **+5V** terminal and the **i/p** terminal of the Auto-man i/p connector (J1). Closed switch for automatic control; open switch for manual control. Alternatively a logic input may be applied to the **i/p** terminal of the Auto-man i/p connector, ground to the **0V** terminal. High input for automatic control; low input for manual control.

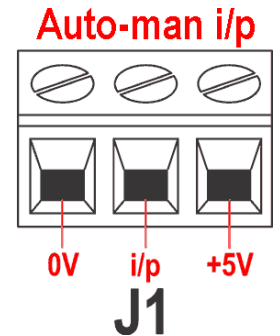

22.10 MemoDose input

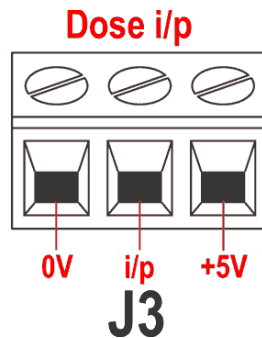

Connect a momentary contact switch such as a footswitch or a handswitch between the **5V** terminal and the **i/p** terminal of the Dose i/p connector (J3). Close the switch to begin a dose. This input is software-debounced and functions in a similar way to the other remote inputs, such as with 5V to 24V logic as shown above, using the **i/p** terminal and the **0V** terminal. **Note:** This input is software-debounced, so the signal can be either momentary or maintained during the dose. If maintained, the signal must be removed before the next dose.

22.11 Leak detection input

Connect a remote leak-detection device between the **+12V** terminal and the **i/p** terminal on the Tube monitor connector (J9). Closed circuit indicates a leak. Alternatively a logic input may be applied to the **i/p** terminal, ground to the **0V** terminal. High input indicates a leak. Connect the cable of a Watson-Marlow Tube monitor leak detector as follows:

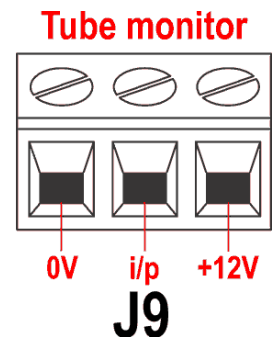

Tube monitor wire colour	620N module
Blue	J9 0V terminal
Yellow	J9 i/p terminal
Red	J9 +12V terminal

Terminate the screen in the 620N module with a 360° EMC gland if required. See 22.2 Wiring up.

Note: Use only Watson-Marlow 620 series tube monitors.

Important: pump status outputs

Outputs 1-4 are available as single-pole change-over relay contacts: Relay 1, 2, 3 and 4. Connect to the normally open or normally closed contacts of the relay as required and configure the pump's software accordingly. See 18.10 Outputs.

Note: The maximum rating on the relay contacts of this pump is 30V DC; maximum load 30W.

Note: Also suitable for low power: ie, 1mA at 5VDC minimum.

22.12 Outputs 1, 2, 3, 4

Note: Relay 1 (J14) is represented here. Relay 2, Relay 3 and Relay 4 (J15, J16 and J17) function identically.

Connect your output device to the **c** (common) terminal of your chosen relay connector and either the **n/c** terminal or the **n/o** terminal (normally closed or normally open) as required. Configure the pump's software accordingly. See 18.10 Outputs.

By default, Relay 1 is configured to indicate Run/Stop status; Relay 2 is configured to indicate Direction status; Relay 3 is configured to indicate Auto/man status; Relay 4 is configured to indicate General alarm status. See 12 Switching the pump on for the first time.

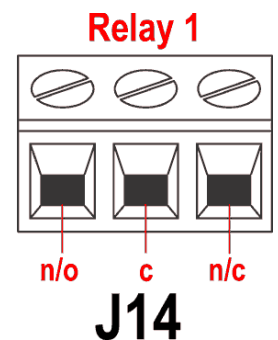

22.13 Supply voltages

An appropriate voltage supply is available where required on each connector. In addition, supplies may be drawn from the Spare supplies connector (J12).

In the table below, "Max load" is the maximum total load on each supply, irrespective of the number of connections.

DC Voltage	Max load	Typical use
+5V	10mA	Voltage supply for inputs using remote switch. Possible voltage supply for outputs if only 5V is required.
+12V	10mA	Possible voltage supply for inputs using remote switch. Possible voltage supply for outputs. Voltage supply for Watson-Marlow Tube Monitor leak detector. Part voltage supply (-12V also needed) for the Watson-Marlow proximity switch.
-12V	10mA	Part voltage supply (+12V also needed) for the Watson-Marlow proximity switch.
+10V (from J7)		Reference voltage for remote potentiometer speed control. Do not use as a general supply voltage.

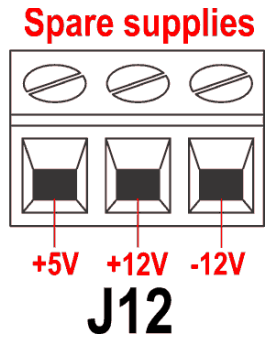

Note: All DC supplies are stabilised.

22.14 RS485 input

Connect your network link to J10 using a screened twisted pair: A to A, B to B, screen to 0V. Ensure that the pump is configured to operate under Network control. More than one pump may be controlled with the same RS485 signal: connect all pumps in parallel. See 25 Network control and operation.

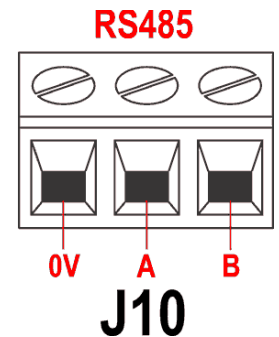

23 Automatic control wiring without the 620N module

Interfacing the pump with other devices is by means of three D-connectors at the rear of the pump. There are two 25-way D-connectors. The top one is male, the bottom one is female. Mating female and male connectors, screened for EMC compatibility, must be conventionally soldered to screened control cables.

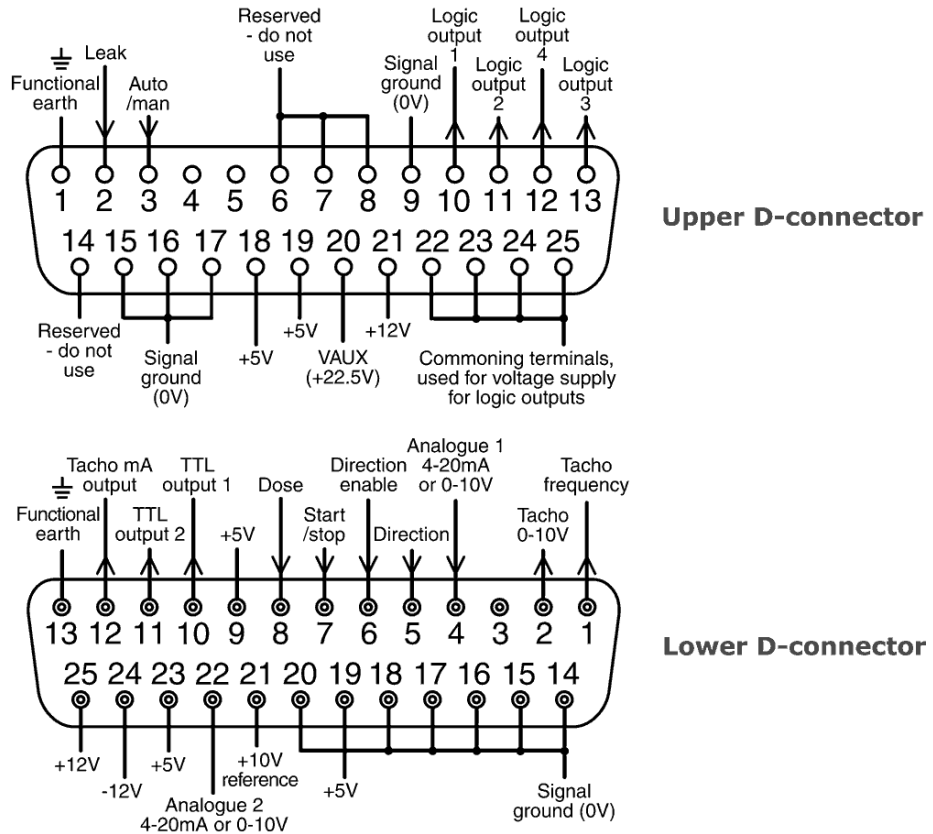

Recommended control cable: 7 strands 0.2mm, 24AWG, screened, circular, up to 25-core. The cable screen should be earthed either through the functional earth pin on the D-connector (pin 1 on the upper (male) 25-way D-connector) (pin 13 on the lower (female) 25-way D-connector), or through the metalwork of the socket or plug.

This pump passes all EMC compatibility requirements with up to 25m (82ft) of the cable type specified above. Beyond this distance it is the user's responsibility to ensure the pump's safe and reliable operation under remote and automatic control.

Do not strap the control and mains power cables together.

The 0V lines on this pump are mains transformer-isolated from ground (floating ground). It can be connected to isolated 0V or grounded 0V interfaces. The TTL (transistor transistor logic) outputs 1 and 2 used here are composed of two states: nominally 0V and 5V; but in practice <0.4V (<16mA) and 2.4-5V (<0.4mA). They are not suitable for driving relays. If a relay is to be driven by the TTL signal, it must be done as described under Logic output 1-4, below.

RS232 control

RS232 network control is available via a 9-pin D-connector wired as below.

RS232 is the mode which allows the pump to be controlled by computers and process controllers. It can control every function of the pump, and pass data back to the controller for closed loop operation. Up to 16 pumps can be individually controlled.

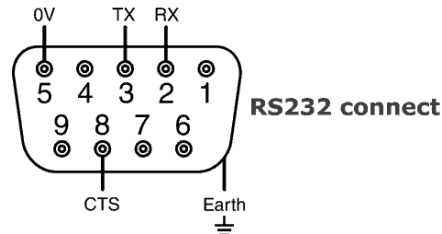

Recommended control cable: 7 strands 0.2mm, 24AWG, screened, circular, up to 4-core. The cable screen should be earthed through the metalwork of the shell.

This pump passes all EMC compatibility requirements with up to 3m (10ft) of the cable type specified above. Beyond this distance it is the user's responsibility to ensure the pump's safe and reliable operation under remote and automatic control.

The 0V lines on this pump are mains transformer-isolated from ground (floating ground).

Basic RS232 cabling

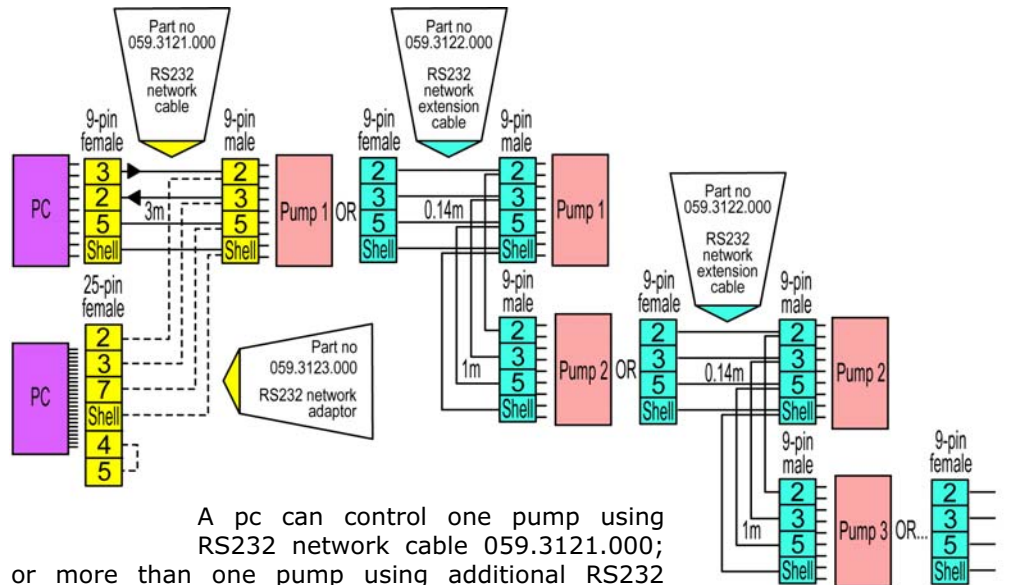

A pc can control one pump using RS232 network cable 059.3121.000; or more than one pump using additional RS232 network extension cables 059.3122.000, up to a maximum of 16 pumps. If a connection must be made to a pc fitted with a 25-pin serial outlet, use RS232 network adaptor 059.3123.000, shown, dotted, left, instead of 059.3121.000.

RS232 settings

Baud	Set in Setup, Baud. Factory default is 9600	Parity	None
Stop bits	2	Handshake	None
Data bits	8	Auto echo	On

Pin	Function	Pin	Function
1	-	6	-
2	RX (receive data)	7	-
3	TX (transmit data)	8	CTS (clear to send. Active = low)
4	-	9	-
5	0V	Shell	

Note: The CTS connection to pin 8 is optional, for use when error conditions are required.



Never apply mains voltage to the D-connectors. Apply the correct signals to the pins shown. Limit signals to the maximum values shown. Do not apply voltage across other pins. Permanent damage, not covered by warranty, may result.

23.1 Speed: analogue input 1

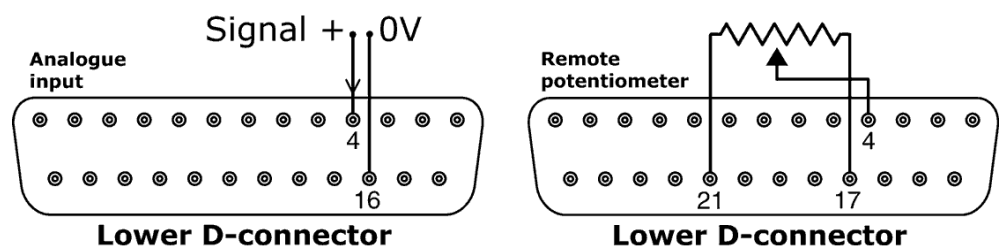

It is possible to control the speed of the pump remotely by one of these methods: a voltage analogue signal within the ranges 0-10V or 1-5V; or a current analogue signal within the range 4-20mA; or a remote potentiometer.

The analogue process signal must be applied to pin 4 of the lower D-connector. 0V to pin 16. The pump will provide an increasing flow rate for a rising control signal (non-inverted response) or an increasing flow rate for a falling control signal (inverted response). See 18.2 Analogue in the Setup menu.

4-20mA circuit impedance: 250Ω.

For voltage modes, a stable, reliable voltage source can be used with a DC voltmeter. Circuit impedance: 22kΩ.

Inverting the response is set up in software. Do not invert the polarity of the pins.

A remote potentiometer with a nominal value of between 1k and 2k with a minimum of 0.25W should be wired as shown. When using a remote potentiometer, do not apply a voltage or current control input signal at the same time. The speed control signal will require calibration relative to the minimum and maximum settings of the potentiometer. This is done in software - see 18.1 Trim in the Setup section.

When using a remote potentiometer, it is important to set the analogue input to voltage in the Setup menu. Otherwise the reference voltage supply from pin 21 will be overloaded and will not provide a full 5V or 10V.

23.2 Scaling: analogue input 2

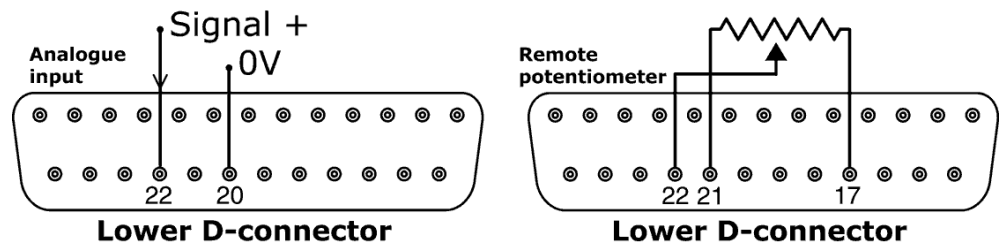

It is possible to scale the speed of the pump remotely by one of these methods: a voltage analogue signal within the ranges 0-10V or 1-5V; or a current analogue signal within the range 4-20mA; or a remote potentiometer.

The analogue scaling signal must be applied to pin 22 of the lower D-connector. 0V to pin 20. The speed of the pump as set by Analogue 1 is scaled in proportion to the signal from Analogue 2 according to the formula $y=as$, where a is the speed set by Analogue 1, s is the scaling set by Analogue 2 (0V or 4mA = 0, increasing linearly to 10V or 20mA = 1), and y is the scaled rotation speed. If Analogue 2 has been set for an inverted response, the reverse is true. See 18.2 Analogue in the Setup menu.

4-20mA circuit impedance: 250Ω.

For voltage modes, a stable, reliable voltage source can be used with a DC voltmeter. Circuit impedance: 22kΩ.

Inverting the response is set up in software. Do not invert the polarity of the pins.

A remote potentiometer with a nominal value of between 1k and 2k with a minimum of 0.25W should be wired as shown. When using a remote potentiometer, do not apply a voltage or current control input signal at the same time. The speed control signal will require calibration relative to the minimum and maximum settings of the potentiometer. This is done in software - see 18.1 Trim in the Setup section.

When using a remote potentiometer, it is important to set the analogue input to voltage in the Setup menu. Otherwise the reference voltage supply from pin 21 will be overloaded and will not provide a full 5V or 10V.

23.3 Speed: analogue output

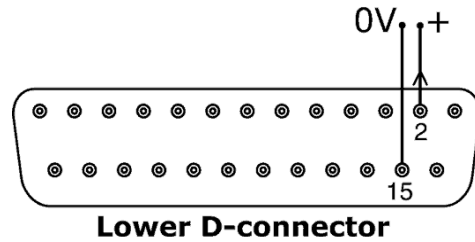

An analogue output signal is available as a 0V-10V signal on pin 2 of the lower D-connector. Ground to pin 15. The voltage is fixed and directly proportional to the pumphead rotation speed. 0V = zero speed; 10V = maximum speed.

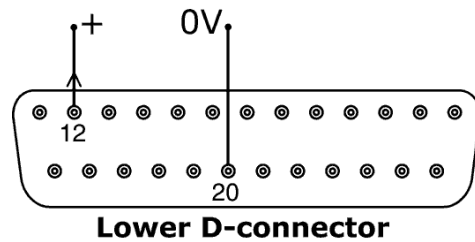

An analogue output signal is available as a 4-20mA signal on pin 12 of the lower D-connector, requiring a 250Ω resistor in series. Ground to pin 20. The current is fixed and directly proportional to the pumphead rotation speed. 4mA = zero speed; 20mA = maximum speed.

23.4 Tachometer frequency output

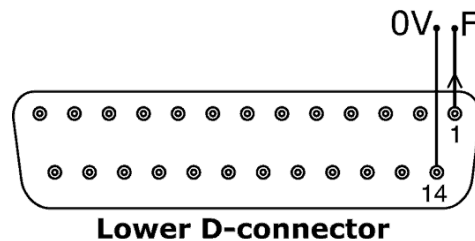

A tachometer frequency output is available on pin 1 of the lower D-connector. Ground to pin 14. It provides a +5V square wave pulse, maximum 0.5mA, the frequency of which is directly proportional to pumphead rotation speed. It provides 5.578 Hz/rpm - 334 pulses per output shaft revolution. The pulse train from the pump can be used to calculate the speed of rotation or to determine the number of pumphead revolutions. This output has the required strength to be effective up to 3m from the pump. Longer cable runs require signal amplification.

Important: general instructions for remote control inputs

All remote control inputs can be wired in two ways:

Logic

A logic voltage between 5V TTL and 24V industrial logic may be wired to the input pin. The pump is configured to operate without modification anywhere in this range. Any of the 0V pins is connected to the control device's 0V to make the circuit. One 0V pin is identified in the wiring diagram, but any may be used. Low is equivalent to 0V. High is equivalent to 5V→24V.

Switch

A remote switch may be connected between the input pin and any positive voltage supply from the pump. One 5V supply pin is identified in the wiring diagram but there are several which will do, either 5V or other positive voltage. However, do not use pin 21 on the lower D-connector or pin 20 on the upper D-connector.

23.5 Run/stop input

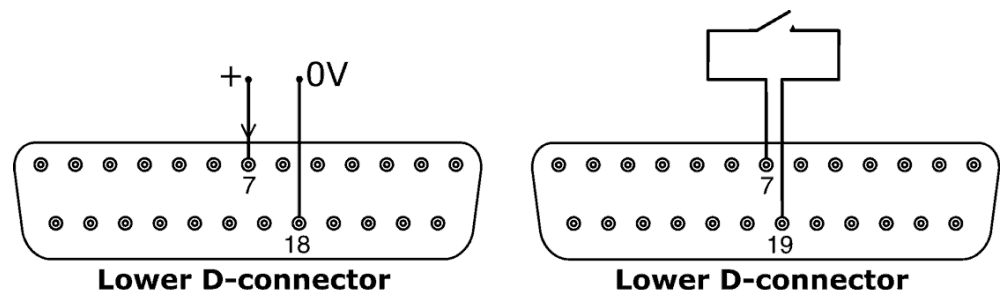

Remote run/stop: connect a remote switch between pins 7 and 19 of the lower D-connector. Alternatively a logic input may be applied to pin 7 of the lower D-connector, ground to pin 18. High input stops the pump, low input runs the pump. With no connection or with the switch open, the pump will default to running. To change or set the sense of the run/stop input, see 18.11 Remote stop in the Setup menu.

23.6 Direction input

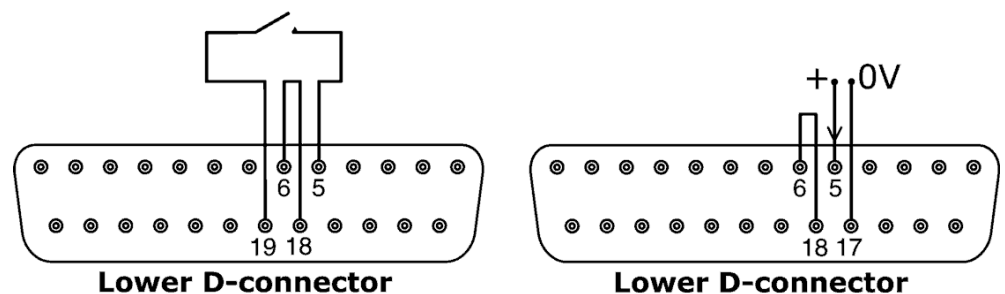

To enable remote direction control and disable the **DIRECTION (SHIFT, 1)** key on the keypad, link pins 6 and 18 of the lower D-connector. Connect a remote switch

between pins 5 and 19 of the lower D-connector. Open switch for clockwise rotation, closed switch for counter-clockwise rotation. Alternatively a logic signal may be applied to pin 5 of the lower D-connector, ground to pin 17. Low input for clockwise rotation, high input for counter-clockwise rotation. With no connection the pump defaults to clockwise rotation.

23.7 Auto / manual toggle input

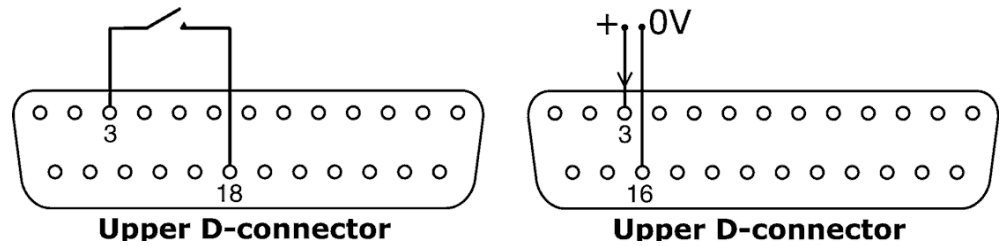

Connect a remote switch between pins 3 and 18 of the upper D-connector. Closed switch for automatic control; open switch for manual control. Alternatively a logic input may be applied to pin 3 of the upper D-connector, ground to pin 16. High input for automatic control; low input for manual control.

23.8 MemoDose input

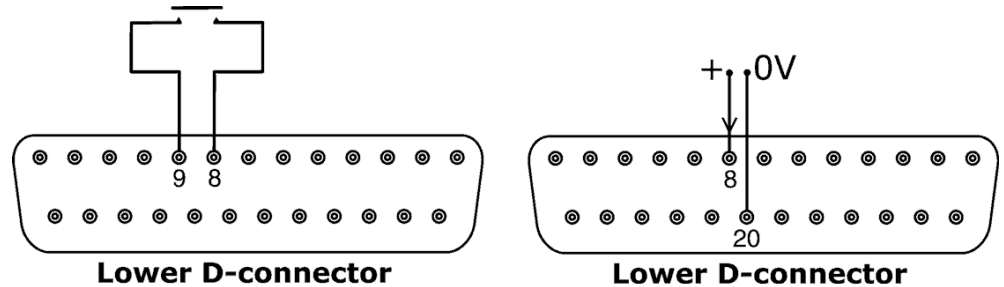

Connect a momentary contact switch such as a footswitch or a handswitch between pins 8 and 9 of the lower D-connector. Close the switch to begin a dose. This input is software-debounced and functions in a similar way to the other remote inputs, such as with 5V to 24V logic as shown above, using pin 8 as the input and pin 20 as the 0V (lower D-connector). **Note:** This input is software-debounced, so the signal can be either momentary or maintained during the dose. If maintained, the signal must be removed before the next dose.

23.9 Leak detection input

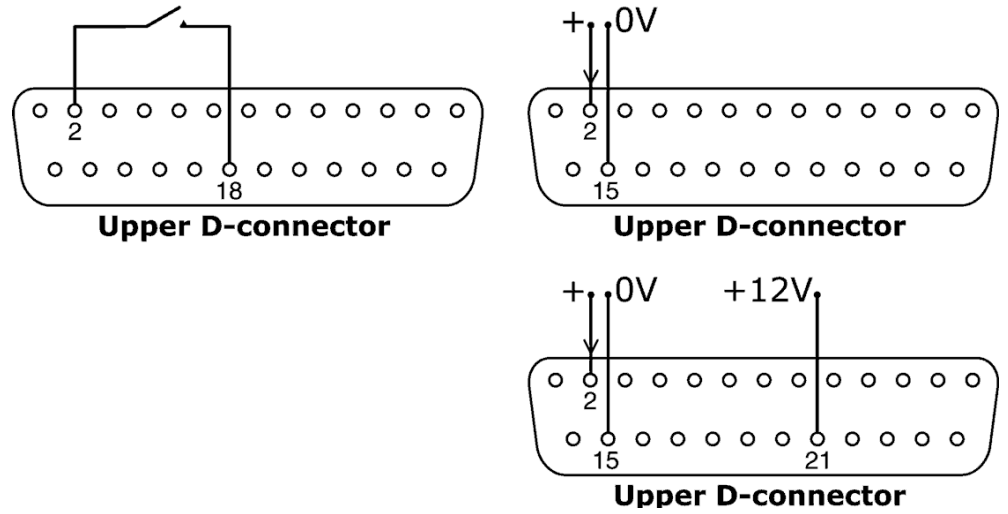

Connect a remote leak-detection device between pins 2 and 18 of the upper D-connector. Closed circuit indicates a leak. Alternatively a logic input may be applied to

pin 2 of the upper D-connector, ground to pin 15. High input indicates a leak. Connect a Watson-Marlow leak detector in the same way, drawing 12V to power it from pin 21 of the upper D-connector.

Connect the cable of a Watson-Marlow Tube monitor leak detector as follows:

Tube monitor wire colour	Pin number upper D-connector
Blue	15
Yellow	2
Red	21

Note: Use only a Watson-Marlow 620 series tube monitor.

23.10 Pump status outputs

Important: pump status outputs

All four outputs can be configured in software to output a range of parameters: see 18.10 Outputs under Setup.

Outputs 1 and 2 are available simultaneously from the upper and lower D-connectors. The outputs from the lower D-connector operate at 5V TTL only.

All four outputs available from the upper D-connector are open-collector.

By applying a positive voltage to a maximum of 24V to pin 22 of the upper D-connector, all the outputs from this plug are at that voltage: pin 22 is commoned with pins 23, 24 and 25. Care must be taken to ensure that the supply voltage has sufficient capability to drive all the loads applied to all outputs used. **Important: The total load of the four logic outputs must not exceed 50mA.**

23.10.1 Logic output 1

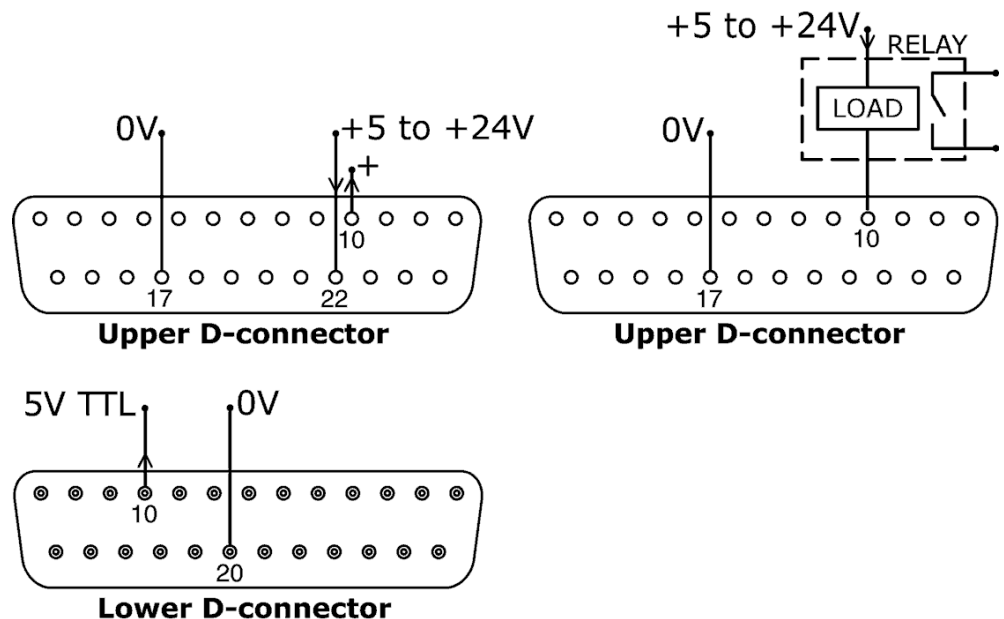

Output 1 is taken from pin 10 of the upper D-connector, depending on the logic state of the function assigned to Output 1. Alternatively, a load such as a relay coil may be connected to pin 10, ground to pin 17. Current will flow through the circuit depending on the logic state of the function assigned to Output 1. Do not connect to any device requiring more than 50mA.

Additionally, output 1 is available as a 5V TTL logic signal on pin 10 of the lower D-connector. It will change state corresponding to the logic state of the function assigned to Output 1. Do not connect to any device requiring more than 1 TTL load.

By default, output 1 is configured to indicate Run/Stop status. See 12 Switching the pump on for the first time.

23.10.2 Logic output 2

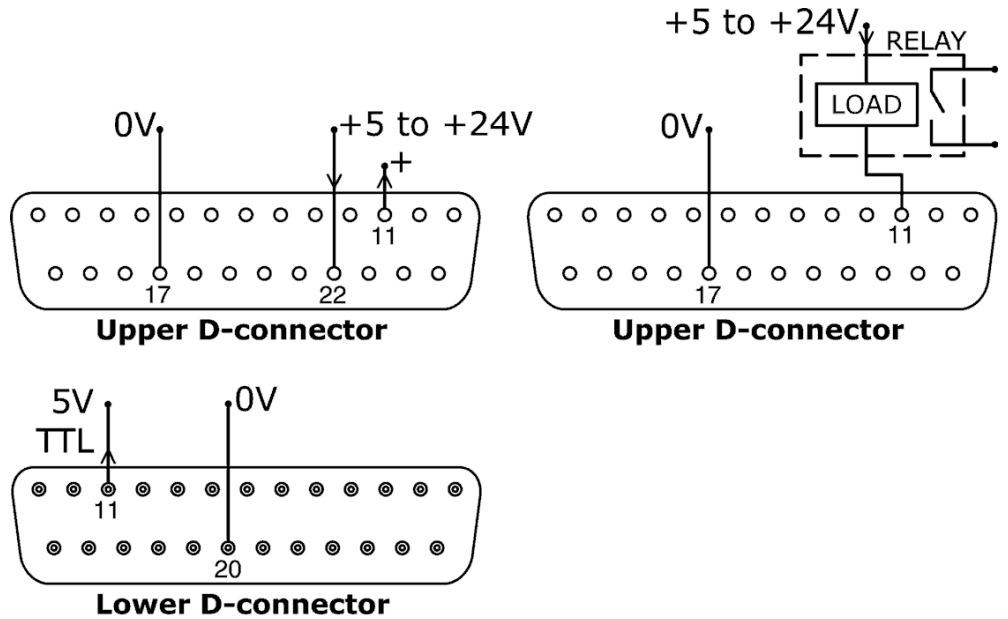

Output 2 is taken from pin 11 of the upper D-connector, depending on the logic state of the function assigned to Output 2. Alternatively, a load such as a relay coil may be connected to pin 11, ground to pin 17. Current will flow through the circuit depending on the logic state of the function assigned to Output 2. Do not connect to any device requiring more than 50mA.

Additionally, output 2 is available as a 5V TTL logic signal on pin 11 of the lower D-connector. It will change state corresponding to the logic state of the function assigned to Output 2. Do not connect to any device requiring more than 1 TTL load.

By default, output 2 is configured to indicate Direction status. See 12 Switching the pump on for the first time.

23.10.3 Logic output 3

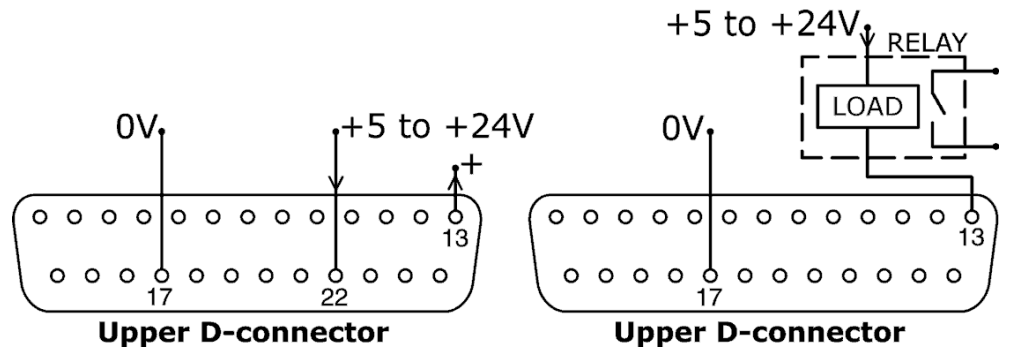

Output 3 is taken from pin 13 of the upper D-connector, depending on the logic state of the function assigned to Output 3. Alternatively, a load such as a relay coil may be connected to pin 13, ground to pin 17. Current will flow through the circuit depending on the logic state of the function assigned to Output 3. Do not connect to any device requiring more than 50mA.

By default, output 3 is configured to indicate Auto/Man status. See 12 Switching the pump on for the first time.

23.10.4 Logic output 4

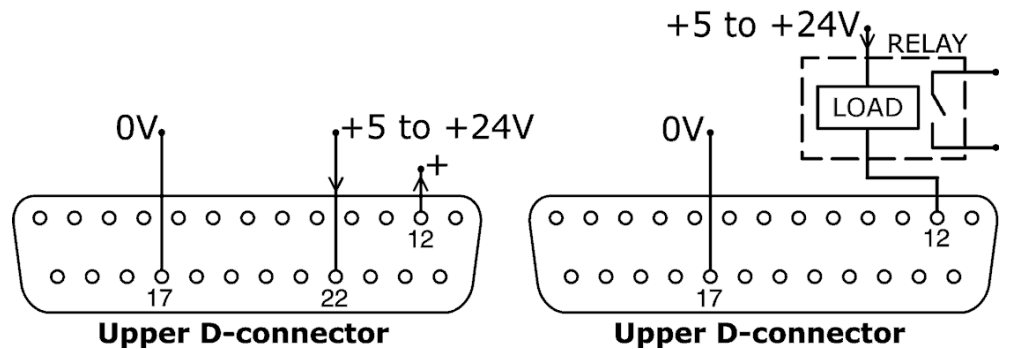

Output 4 is taken from pin 12 of the upper D-connector, depending on the logic state of the function assigned to Output 4. Alternatively, a load such as a relay coil may be connected to pin 12, ground to pin 17. Current will flow through the circuit depending on the logic state of the function assigned to Output 4. Do not connect to any device requiring more than 50mA.

By default, output 4 is configured to indicate General alarm status. See 12 Switching the pump on for the first time.

23.11 Supply voltages

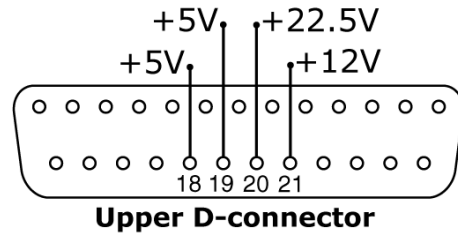

Upper D-connector

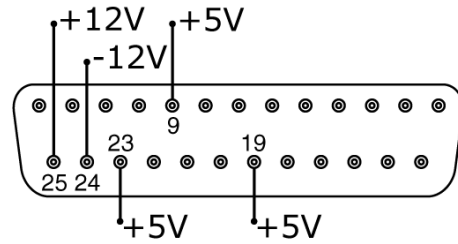

Lower D-connector

In the table below, "Max load" is the maximum total load on each supply irrespective of the number of connections.

DC Voltage	Max load	Lower D	Upper D	Typical use
+5V	10mA	9, 19, 23	18, 19	Voltage supply for inputs using remote switch. Possible voltage supply for outputs if only 5V is required. Pin 9 is specifically used for footswitch / handswitch operation
+12V	10mA	25	21	Possible voltage supply for inputs using remote switch. Possible voltage supply for outputs. Voltage supply for Watson-Marlow Tube Monitor leak detector. Part voltage supply (-12V also needed) for the Watson-Marlow proximity switch
-12V	10mA	24	-	Part voltage supply (+12V also needed) for the Watson-Marlow proximity switch
+22.5V	-	-	20	Voltage supply for the 620N wash-down module. Do not use
+10V	-	21	-	Reference voltage for remote potentiometer speed control. Do not use as a general supply voltage

Note: All DC supplies are stabilised except the +22.5V.

24 Automatic control and operation

Check that the pump is ready to run before selecting automatic operation. Remote control signals may start the pump without warning.

How to get into auto operation

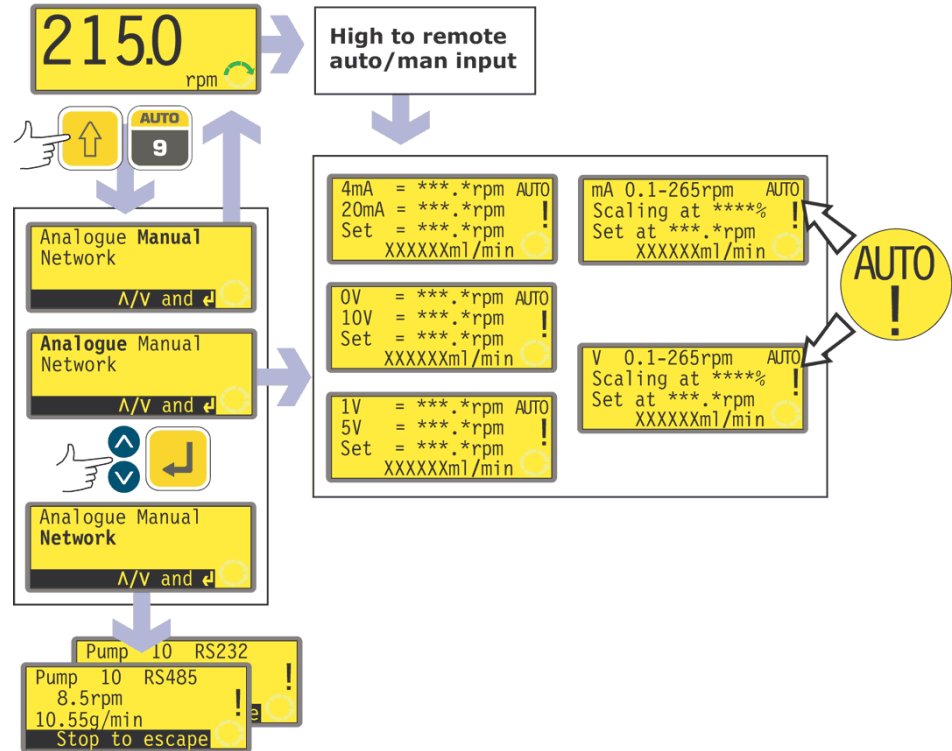

- While the manual mode main screen is displayed, press **AUTO (SHIFT, 9)**, or apply a high signal (5-24V) to the remote auto / manual input.
- If auto entry was triggered remotely, the pump responds to the analogue signal as soon as this is done and shows the "AUTO" icon.
- If auto entry was triggered using **AUTO (SHIFT, 9)**, the pump offers three choices: **Analogue, Manual** and **Network**. Use the **UP** and **DOWN** keys to choose and press **ENTER** to confirm.
 - Selecting **Manual** returns the user to the manual mode main screen. See 14 Manual operation.
 - Selecting **Network** puts the pump into network (RS232 or RS485) mode. See 25 Network control and operation.
 - Selecting **Analogue** puts the pump into analogue mode. It responds to the analogue signal as soon as this is done and shows the "AUTO" icon.
- The pump is automatically switched into auto-restart mode and displays the ! icon. The only keys active are **STOP, MAN (SHIFT, 6), DIRECTION (SHIFT, 1)** and **START** (available only as an extended keypress to toggle keypad lock). **UP** and **DOWN** keys are available if manual scaling has been set (see below).
- If the remote direction input is active and the direction-enable link is applied, the **DIRECTION (SHIFT, 1)** key is disabled. If keypad lock is set, only **STOP** and **START** (available as an extended keypress to toggle keypad lock) are active.
- The pump displays whichever of six auto running screens is appropriate according to the previously selected auto mode - 4-20mA, 1-5V or 0-10V with or without scaling in place.
- The auto running screens display four pieces of information: the speed at which

the pump rotates after receiving a low signal on Analogue 1 (4mA, 1V or 0V); the speed at which the pump rotates after receiving a high signal on Analogue 1 (20mA, 5V or 10V); the set speed (that is: the speed at which the pump is currently rotating according to the analogue speed signal and the analogue scaling signal if scaling is set); and the flowrate in the units selected (see 18.8 Flow units). The scaling percentage is also displayed if it is set.

- If manual scaling is enabled using the Setup menu (see 18.2 Analogue), the scaling percentage can be adjusted between 0% and 100% using the **UP** and **DOWN** keys.
- The pump responds to remote digital inputs. If the run/stop input stops the pump, the bottom line of the auto running screen shows "Remote stop". When it starts the pump again, this will disappear and the pump returns to normal running mode.
- If the pump is stopped because a leak is detected, the screen displays "LEAK DETECTED. Check and reset, then press Stop". See 26.1 Error codes.
- The remote status outputs operate fully.

How to get out of auto operation

- If you entered auto operation by pressing **AUTO (SHIFT, 9)** and selecting **Analogue**, return to manual operation by pressing **MAN (SHIFT, 6)**.
- If you entered auto operation by making the remote auto / manual input go high, leave auto operation by making the remote auto / manual input go low (0V).
- The pump returns to manual operation and retains the set speed and run status from its previous operation in analogue mode.

Emergency stop

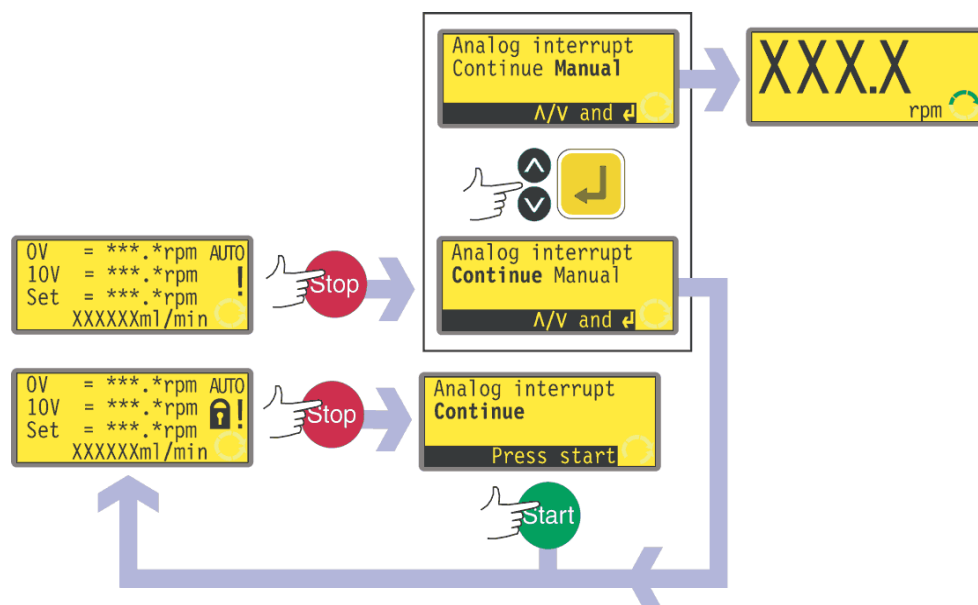

In an emergency press the **STOP** key. The pump stops and displays an interruption screen.

- If keypad lock is in place when **STOP** is pressed, or if the pump is in auto mode via the digital input, the interruption screen offers one key-press: press **START** to continue auto operation.
- If keypad lock was not in place when **STOP** was pressed, the interruption screen offers a choice: **Continue** to continue auto operation, or **Manual** to switch to manual mode. Use the **UP** and **DOWN** keys to choose and press **ENTER** to confirm.

25 Network control and operation

Check that the pump is ready to run before selecting network operation. Remote control signals may start the pump without warning.

How to get into network operation

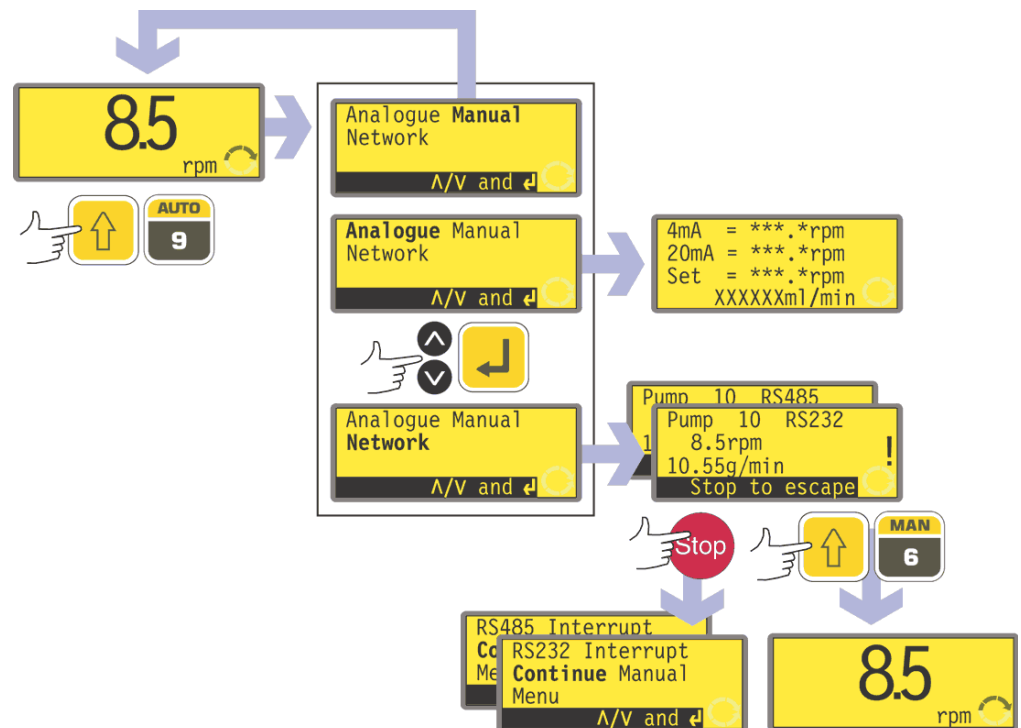

- While the manual mode main screen is displayed, press the **AUTO (SHIFT, 9)** key.
- The pump offers three choices: **Analogue**, **Manual** and **Network**. Use the **UP** and **DOWN** keys to choose and press **ENTER** to confirm.
 - Selecting **Manual** returns the user to the manual mode main screen. See 14 Manual operation.
 - Selecting **Analogue** puts the pump into analogue mode. See 24 Automatic control and operation.
 - Selecting **Network** puts the pump into network (RS232 or RS485) mode.
- The pump is automatically switched into auto-restart mode and displays the **!** icon. The only keys active are **STOP**, **MAN (SHIFT, 6)** and **MENU (SHIFT, 7)**.
- Remote stop, auto/man, dose, direction enable and direction inputs are inactive. Leak input is active. See 26.1 Error codes.
- All pump status outputs are active.

How to get out of network operation

- Pressing the **MAN (SHIFT, 6)** key sets the pump to manual operation and retains the set speed and run status from its previous operation in network mode. See 14 Manual operation.

Emergency stop

- In an emergency press the **STOP** key. The pump stops and displays an interruption screen, from which select **Continue** to return to network control, **Manual** to set the pump to manual control (see 14 Manual operation), or **Menu** to display the main menu (see 15 Main menu). Use the **UP** and **DOWN** keys to choose and press **ENTER** to confirm.

25.1 RS232 and RS485 command strings

Command	Parameters	Meaning
nCA	-	Clear LCD display
nCH	-	Home the cursor
nDO	xxxxxxxxxx<,yyyyy>	Set and run one dose of xxxxxxxxxx tacho pulses, with optional drip of yyyyy (maximum 11,000) tacho pulses. See note 1
nTC	-	Clear the cumulative tachometer count
nSP	xxx.x	Set speed to xxx.x rpm
nSI	-	Increment speed by 1rpm
nSD	-	Decrement speed by 1rpm
nGO	-	Start running
nST	-	Stop running
nRC	-	Change direction
nRR	-	Set direction to clockwise
nRL	-	Set direction to counter-clockwise
nRS	-	Return status. See note 2
nRT	-	Return the cumulative tachometer count
nW	[line 1]~[line 2]~[line 3]~[line 4]@	Display text on 1 to 4 lines with ~ as the line delimiter. Terminated by the @ character. See note 3
nZY	-	Return 0 for stopped or 1 for running

Note 1: The correlation between tachometer pulses and motor rotation is fixed and provides a measurable and absolute way of monitoring the number of revolutions of the gearbox output shaft - 10,982 pulses per revolution. This in turn allows the count to be equated to the amount of material dispensed - assuming that the pumphead type and tube size are known.

Note 2: The status is returned to the sender in the following format: [pump type] [ml/rev] [pumphead] [tube size] [speed] [CW/CCW] P/N [pump number] [tacho count] [0/1 (stopped/running)] !

For example: 620Du 15.84 620R 9.6MM 220.0 CW P/N 1 123456789 1 !

Note 3: If the pump speed is changed subsequently, the pump must display the screen shown here (example figures only) for 4 seconds before reverting to the custom display. 1 to 4 lines of text can be written with ~ as the line delimiter and @ as the message end.

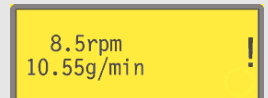

i.e., 1W620Du@ and 1W620Du~@ are both valid commands.

Note 4: 'n' can be any number from 1 to 16 inclusive (1 to 32, 620DuN), and by exception the # symbol can be used as an all-drives command; but not with the RS, RT or ZY commands, as the results would be indeterminate.

26 Troubleshooting

If the pump display remains blank when the pump is on, make the following checks:

- Check the position of the voltage selector switch at the rear of the pump.
- Check the mains power switch at the rear of the pump.
- Check that mains power is available to the pump.
- Check the fuse in the fuseholder in the centre of the switchplate at the rear of the pump.
- Check the fuse in the mains power plug if one is present.

If the pump runs but there is little or no flow, make the following checks:

- Check that the tube and rotor are in the pumphead.
- Check that fluid is supplied to the pump.
- Check that the tube is not split or burst.
- Check for any kinks or blockages in the lines.
- Check that any valves in the lines are open.
- Check that the correct wall-thickness tube is being used.
- Check direction of rotation.
- Check that the rotor is not slipping on the drive shaft.

26.1 Error codes

If an internal error occurs, a flashing error screen is displayed. **Note: Signal out of range, Over signal, No signal and Leak detected** error screens report the nature of an external signal. They do not flash.

Error condition	Suggested action
RAM write error	Attempt to reset by switching power OFF / ON. Or seek support
RAM corruption	Attempt to reset by switching power OFF / ON. Or seek support
OTP ROM error / corruption	Attempt to reset by switching power OFF / ON. Or seek support
OTP ROM read error	Attempt to reset by switching power OFF / ON. Or seek support
Unknown pump type	Check the interface card and cables. Attempt to reset by switching power OFF / ON. Or seek support
Display failure	Seek support
Wrong key-press	Attempt key-press again. Attempt to reset by switching OFF / ON
Motor stalled	Stop pump immediately. Check pumphead and tube. Power OFF/ON may reset. Or seek support
Tacho fault	Stop pump immediately. Power OFF/ON may reset. Or seek support
Speed error	Stop pump immediately. Power OFF/ON may reset. Or seek support
Over current	Stop pump immediately. Check system. Power OFF/ON may reset. Or seek support
Over voltage	Stop pump immediately. Check mains voltage selector switch. Check supply. Power OFF/ON may reset. Or seek support
Under voltage	Stop pump immediately. Check mains voltage selector switch. Check supply. ON/OFF may reset. Or seek support
Watchdog error	Attempt to reset by switching power OFF / ON. Or seek support
Over temperature	Stop pump immediately. Turn OFF. Seek support
Signal out of range	Check analogue control signal range. Trim signal as required. Or seek support
Over signal	Reduce the analogue control signal
No signal	Connect analogue control signal or return to manual control
Leak detected. Check and reset	Remove the cause of any leak. The STOP key resets
Unrecognised key-press	Attempt key-press again. Attempt to reset by switching power OFF/ON. Or seek support
Work overload	Turn OFF. Check power supply. Check pumphead and tubing. Wait 30 minutes. Power ON may reset. Or seek support
Network not detected	Turn OFF. Check network and connections. Or seek support
RS485/RS232 fault	Turn OFF. Check network and connections. Or seek support
RS485/RS232 lost	Turn OFF. Check network and connections. Or seek support
General error condition	Turn OFF. Seek support

DuN, Du

27 Drive maintenance

There are no user serviceable parts inside the pump. The unit should be returned to Watson-Marlow or its appointed agents or distributors for service.

DuN, Du

28 Drive spares

Replaceable main fuse, type T5A H 250V: FS0043

Foot: MR3002M x5

DuN, Du

Pumphead use is independent of drive ingress protection. No reference to ingress protection rating or drive model (620DuN or 620Du) is made throughout the pumphead sections of this manual.

29 620RE MarkII, 620RE4 MarkII and 620R MarkII pumpheads

Note: MarkII pumpheads differ from MarkI pumpheads as follows: they have a new guard-switching arrangement which is not compatible with 623/624 drives. Similarly, older guards are incompatible with 620 drives. Elsewhere in this manual, the term "MarkII" is omitted.

29.1 620RE, 620RE4 and 620R key safety information



Before opening the pumphead guard please ensure that the following safety directions are followed.

- Ensure that the pump is isolated from mains voltage.
- Ensure that there is no pressure in the pipeline.
- If a tube failure has occurred, ensure that any product in the pumphead has been allowed to drain through the controlled waste to a suitable drain.
- Ensure that protective clothing and eye protection are worn if hazardous products are being pumped.

29.2 620RE, 620RE4 and 620R safe-guarding

- Primary safety on 620 series pumps is provided by the tool-lockable pumphead guard. Secondary (backup) protection is provided in the form of an electrical guard switch which stops the pump if the pumphead guard is opened. The electrical guard switch on cased pumps should never be used as primary protection. Always disconnect the mains power supply to the pump before opening the pumphead guard.

29.3 620RE, 620RE4 and 620R pumping conditions

Pressure and viscosity

- All pressure values in this operating instruction, from which performance and life figures have been calculated, relate to peak pipeline pressures.
- Although rated to 4 bar peak pressure, this pump will generate in excess of 4 bar peak pressure if pipeline restrictions are in place. In instances where it is critical that a peak pressure of 4 bar is not exceeded, pressure relief valves should be installed in the pipeline.
- For pumping duties of 2-4 bar pressure, fit hard Marprene/Bioprene or standard Sta-Pure or Chem-Sure tube elements. "M" or "P" in the tube element's product order code denotes suitability for higher pressure use.
- For pumping duties of 0-2 bar pressure, use standard hardness elements or the standard range of continuous peristaltic pump tubing.
- Viscosity handling is maximised by using hard Marprene/Bioprene or Sta-Pure tube elements in the pumphead.
- Ensure that there is always a minimum of one metre of smooth bore flexible tubing connected to the discharge port of the pumphead. This will help minimise any impulse losses and pulsation in the pipeline. This is especially important with viscous fluids and rigid pipework.

29.4 620RE, 620RE4 and 620R pump installation

A correctly engineered installation will promote the best possible tube life, so please ensure that the following guidelines are followed:

- Avoid tight pipeline bends, pipe reducers and excessive lengths of smaller bore tubing than that in the pumphead, particularly in pipelines on the suction side.
- Ensure that connecting pipe work and fittings are suitably rated to handle the predicted pipeline pressure.
- If rigid pipe work comes in close proximity to the pumphead, a drop-out section of pipe work will simplify tube replacement.
- Ensure that the controlled waste blanking plug is in position if the controlled waste port is not in use. See below.
- It is advisable to use controlled waste pipe work if pumping hazardous, aggressive or abrasive fluids or products which will harden in contact with air.



- Connect waste pipe work to the waste port using the coupling adaptor supplied.
- Push out the blanking plug. Drop the threaded waste fitting into place. Secure it with the supplied locking nut. Fully tighten by hand. Ensure that there is adequate clearance underneath the pumphead. Waste pipe work should run to a suitable container or drain.
- The leak detector installation procedure is included in the leak detector kit.
- If unsure of an installation please contact your local Technical Support Office.

29.5 620RE, 620RE4 and 620R general operation



Always isolate the pump from the mains power supply before opening the guard or performing any positioning, removal or maintenance.

Opening the pumphead guard

- Unlock the guard with the 5mm Allen key provided (or a screwdriver).
- Open the guard to its full extent. This creates the maximum clearance between the tube ports and guard to remove the tubing.

Engaging/disengaging the rollers



- The extent of travel of the roller release levers is clear from pictures 2 and 3 above. Do not try and force the levers beyond their normal extent of travel as this will damage the rotor.
- To engage the rollers snap the roller release levers counter-clockwise making sure that the rollers lock out against the tubing. To disengage the rollers, snap the release levers clockwise to their disengaged position. For high pressure tubing elements or four roller pumpheads, a 5mm Allen key can be used to aid leverage when engaging/disengaging the rollers with the release levers.



Make sure that fingers are clear of the rollers and the front face of the rotor hub when using the roller release levers.

Pre-load checks

- Before loading tubing, ensure that all rollers rotate freely, that the tube ports and location grooves are clean and that if in use, the controlled waste pipe work is free of any obstructions.

Closing the pumphead guard and start-up

- Ensure that the guard seal is clean, replacing it if necessary.
- Ensure that the rollers are engaged and locked out against the tubing
- Close the guard and push it against the track until the latch engages.
- Connect suitable pipe work to the pumphead using the appropriate connectors for the tube element. See below.

29.6 620RE and 620RE4 tube element loading



Always isolate the pump from the mains power supply before opening the guard or performing any positioning, removal or maintenance.

620RE element pumpheads are factory set to accept Watson-Marlow LoadSure tube elements. Pumping performance will be adversely affected if LoadSure elements are not used.



- Open the guard using a suitable screwdriver or a 5mm Allen key. Disengage the rollers.
- Locate one of the "D"-shaped flanges into the lower port. (The "D" flange ensures that the element can only be loaded correctly).
- Wrap the tube element around the disengaged rollers of the rotor.
- Locate the second "D"-shaped flange into the upper port.
- Ensure the flat face of each "D" flange sits flush to the flange sealing face of the track.
- Engage the rollers.
- Close the guard and push it against the track until the latch engages.

Connecting LoadSure elements to supply and discharge tubes

LoadSure sanitary elements - which have white connectors - are connected to a tubing system using Tri-clamps and EPDM gaskets.



- Hold the connector end of the supply or discharge tube against the element connector, with an EPDM gasket between them.
- Use a Tri-clamp to engage both flanges squarely, close it and tighten.

LoadSure industrial elements - which have black connectors - are connected to a tubing system using cam-lock (cam and groove) fittings.



- Push the female fitting over the element connector.
- Pull both cam levers closed until they engage.

29.7 620R continuous tube loading



Always isolate the pump from the mains power supply before opening the guard or performing any positioning, removal or maintenance.



- 620R continuous tubing pumpheads are factory set to accept Watson-Marlow 600 series 3.2mm wall tubing. Pumping performance will be adversely affected if Watson-Marlow tubing is not used.
- Select the tube clamp set which is correct for the tubing size to be used.
- Locate the two "U"-shaped track clamp halves into the pumphead ports (The "U"- shape ensures correct loading).
- Locate the corresponding guard clamp halves which have raised "T" locating sections, into the slots on the inner guard face above and below the guard hinge. Push and slide into their locked position.
- Closing the guard will align the two halves of the clamp around the tubing.
- Disengage the rollers.
- Locate one end of the tubing into the lower port "U" clamp and hold firmly in position.
- Wrap the tubing tightly around the retracted rollers, making sure that there is no twisting through its length.
- Locate the other end of the tubing into the upper port "U" clamp.
- Hold both ends of the tubing in one hand maintaining tension around the retracted rollers.
- Engage the rollers.

- Close the guard and push it against the track until the latch engages.
- Ensure that continuous tubing is not loosely clamped at the pumphead ports.
- Ensure that when the pump is re-started all of the rollers have re-engaged. A roller which has not re-engaged will “click” continuously. No damage will occur if this happens but the roller should be re-engaged manually using the 5mm Allen key. See 26 Troubleshooting.

29.8 620RE, 620RE4 and 620R tube element or continuous tube removal



Always isolate the pump from the mains power supply before opening the guard or performing any positioning, removal or maintenance.

- Unlock the guard and disengage the rollers.
- Disconnect the tubing from the external pipeline.
- Remove the tubing from the pumphead.

29.9 620RE, 620RE4 and 620R maintenance

Scheduled maintenance

- The stainless steel pumping rollers run on sealed bearings and do not require lubrication.
- Remove the rotor and lubricate the follower rollers and roller engaging mechanisms with a lithium-based grease. This should be carried out every six months for intermittent duties and every three months for 24 hour duties.
- If fluid is spilled inside the pumphead, flush the pumphead out with water and mild detergent as soon as possible. If specific cleaning agents are required to clean the spillage, please consult Watson-Marlow Technical Support Office before proceeding, in order to confirm chemical compatibility.
- If the rotor needs to be removed, refer to the guidelines below.

Roller adjustment

620 pumpheads have provision for adjustment to reset the roller/track gap to compensate for wear after extended service in arduous applications.

Roller/track gaps can **only** be accurately judged without tubing in the pumphead. The gap should be **4.6mm** for 3.2mm wall tubing and **5.5mm** for LoadSure elements.

If the gap is more than 0.2mm greater than these dimensions, the following may be carried out:

- Note the number on the roller arm to which the engraved line on the hexagon-headed main roller pin corresponds.
- Remove the circlip (snap-ring) and roller pin.
- Relocate the main roller pin, resetting the engraved line to one number lower. For example, if the engraved line was at “-1”, reset it to “-2” to reduce the roller/track gap.

- Ensure the roller pin is correctly seated into the roller arm thrust washer. Replace the circlip.

Rotor removal



- Remove the rotor cover by hand and the central locating bolt using a 5mm Allen key. Pull the rotor off the keyed shaft. Do not use tools to lever the rear face of the rotor away from the inner face of the track: it should come off by hand.

Track removal

- Remove the rotor as described above.
- Disconnect the waste pipework (if attached).



- Loosen the two track retaining screws using a suitable screwdriver.
- Withdraw the track fully from the gearbox.
- After removing the rotor and track, it is advisable to remove the metal key from the keyway, clean and reassemble. The key fits its keyway tightly. It may be freed by tapping gently with a screwdriver or other suitable tool.

Track re-location



- Ensure that the track is clean.
- Align the track so that the location holes are aligned with the threaded holes in the cased drive.
- Tighten the two track retaining screws using a suitable screwdriver.
- Re-connect the waste pipework (if required).

Note: The track can be fitted in two positions: with ports to the right or with ports down. The ports-down position requires that the pump is positioned at the front of the surface it stands on to provide clearance for the supply and discharge tubes.

Rotor re-location



- Before replacing the rotor, locate the key into the driveshaft keyway and apply a thin layer of grease over the shaft and key. The rotor keyway is the largest of the four slots radiating from the driveshaft socket: the top one in the first picture, above. Align the rotor keyway with the shaft key and slide the rotor into position, ensuring that a positive "stop" is achieved and ensure that the full length of the drive shaft is fitted into the rotor.
- Do not force the rotor into position. The rotor will slide into place easily if correctly aligned.
- Secure the rotor with the hexagonal locating bolt (complete with washer) to a nominal torque of 10Nm using a 5mm Allen key.
- The rotor bolt, which is impregnated with "Loctite 218" thread lock, should be subjected to a maximum of three removals/relocations before renewal. To avoid rotor bolt renewal after three removals, apply "Loctite 222" thread lock to the rotor thread before relocation. This is critical to ensure prolonged, secure location of the rotor hub to the drive shaft. **Failure to complete this action will invalidate the terms and conditions of the warranty.**
- Replace the rotor cover.

When closing the guard, check it does not make contact with the rotor. If it does, the rotor has been fitted incorrectly. Re-open the guard, remove and refit the rotor, and close the guard.

29.10 620RE, 620RE4 and 620R CIP and SIP

General

- Unlock the guard and disengage the rollers.
- Close the guard and squeeze against the track until the latch clicks.
- Observe a 1m safety area.

CIP

- LoadSure tube elements and continuous tubing can be cleaned using CIP processes.
- Ensure that the tubing material is chemically compatible with the cleaning agent that is to be used.
- If cleaning agents are spilled over the pumphead, wash down immediately.
- Ensure that controlled waste pipe work is fitted to allow safe release of cleaning agent in the event of a tube failure.

SIP

- Only Sta-Pure tube elements can be used in a steam-in-place sterilisation processes.
- Sta-Pure tubing elements can be sterilised to 3A Class two and FDA minimum recommended standard which is 121C (250F) at 1bar (14.5 psi) saturated steam for 20 minutes.
- Monitor the process continuously.
- If a tube failure occurs, shut down the process. Do not touch the pumphead until a 20 minute cooling period has been observed.
- Ensure a 20 minute acclimatisation period is observed before running the pump following SIP.
- Ensure that controlled waste pipework is fitted to allow a safe release of steam in the event of a tube failure.
- Ensure a 1m safety zone is maintained around the pumphead during SIP cycles.

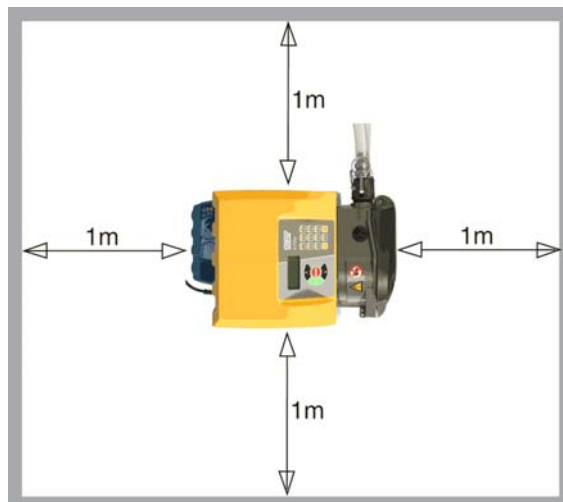



Ensure that the pumphead door is closed and locked before SIP cleaning commences.

29.11 620RE, 620RE4 and 620R pumphead spares



Number	Spare	Description
	063.4211.000	620R MarkII pumphead
	063.4231.000	620RE MarkII pumphead
	063.4431.000	620RE4 MarkII pumphead
1	069.4101.000	620RTC: continuous tubing clamp set
2	MR2052C	Oddie fastener
2	MR2053B	Clip: Oddie retainer
2	MR2054T	Oddie washer
2	SG0021	Oddie spring
2	CX0150	Oddie circlip (snap ring)
3	MRA3020A	Track assembly
4	MRA0249A	Roller assembly (element pumphead)
4	MRA0250A	Roller assembly (continuous pumphead)
5	MR2027T	Controlled waste threaded fitting 620R, RE, RE4
6	MR2028M	Controlled waste port blanking plug
7	MR2018T	Hinge pin
8	MR2055M	Rotor cover
9	MR2021B	Seal - guard
10	MR2002M	Guard without latch and seal
11	MR2096T	Controlled waste threaded fitting locking nut
12	MRA0320A	Rotor assembly 2-roller element
12	MRA0321A	Rotor assembly 4-roller element
12	MRA0322A	Rotor assembly 2-roller continuous
13	XX0220	Key - metal
14	MR2029T	Cased drive MG605 shaft/rotor hub spacer
15	MR2059T	Adaptor - Bodine (white polypropylene ring)
16	FN0488	Cased drive track locating screws M6x10
17	FN0523	Close-coupled track locating screws M6x20
18	FN0581	Rotor locating washer M6
19	MR2251B	Rotor locating bolt M6 x 25
20	TT0006	5mm Allen key
21	MA0017	Magnet

30 620RE, 620RE4 and 620R performance data

Pumping conditions

All performance figures in this operating instruction have been recorded against peak pipeline pressures.

This pump is rated to 4 bar (58psi) peak pressure when fitted with a 620RE, 620RE4 or 620LG pumphead using high-pressure tubing. However, it will generate in excess of 4 bar (58psi) peak pressure if the pipeline is restricted. Where it is important that 4 bar (58psi) is not exceeded, pressure relief valves should be installed in the pipeline.

Viscosity handling is maximised by using 4.0mm wall LoadSure elements with the 620RE and 620RE4 pumpheads.

Flow rates are normalised test values obtained using new tubing with the pumphead rotating clockwise pumping water at 20C with negligible inlet and discharge pressures. Actual flow rates achieved may vary because of changes in temperature, viscosity, inlet and discharge pressures, system configuration and tubing performance against time. Flow rates may also vary due to normal manufacturing tolerances of the tubing. These tolerances will make flow rate variance more pronounced at smaller bore sizes.

For precise and repeatable performance it is important to determine flow rates under operating conditions for each new piece of tubing.

620R and 620L family pumpheads' flow rates are directly proportional to rotor speed. If you wish to run the pump at a speed not shown in the tables below, flow figures can be reached by dividing the maximum flow shown in the tables below by the maximum rpm figure, and multiplying the result by your required speed in rpm.

In normal circumstances, rotor and tube life are maximised if the pumphead is run slowly, particularly when pumping at high pressure. However, to maintain performance at pressures above 2 bar, avoid running the pumphead below 50rpm. If low-flow, high-pressure operation is necessary, switching to a smaller tube is recommended.

Sta-Pure and Marprene TM tubing are hard to compress when new. When using tubing made of these materials, the first five pumphead revolutions should be at a speed of 10rpm or greater. If the pump is run slower, the safety system built into pump drive's software may cause it to stop and display an over-current error message.

Note: Flow rates quoted have been rounded for simplicity, but are accurate to within 5% - well within the normal tubing tolerance variation of flow rate. They should therefore be taken as a guide. Real flow rates in any application must be determined empirically.

30.1 620RE, 620RE4 and 620R flow rates

Metric (SI)

620 Sta-Pure, Chem-Sure, Neoprene, l/min								
	620R				620RE		620RE4	
Speed rpm	6.4 mm	9.6 mm	12.7 mm	15.9 mm	12.0 mm	17.0 mm	12.0 mm	17.0 mm
0.1	0.001	0.003	0.004	0.01	0.004	0.01	0.003	0.01
265	3.2	6.6	11	16	11	18	9.0	13

620 Marprene TL, Bioprene TL, l/min								
	620R (standard)				620RE (standard)		620RE4 (standard)	
Speed rpm	6.4 mm	9.6 mm	12.7 mm	15.9 mm	12.0 mm	17.0 mm	12.0 mm	17.0 mm
0.1	0.001	0.003	0.004	0.01	0.004	0.01	0.003	0.005
265	3.4	6.6	11	12	9.8	18	8.3	12

620 Marprene TM, Bioprene TM, l/min				
	620RE (hard)		620RE4 (hard)	
Speed rpm	12.0 mm	17.0 mm	12.0 mm	17.0 mm
0.1	0.004	0.01	0.003	0.004
265	9.8	16	8.3	11

620 Pumpsil silicone, l/min								
	620R				620RE		620RE4	
Speed rpm	6.4 mm	9.6 mm	12.7 mm	15.9 mm	12.0 mm	17.0 mm	12.0 mm	17.0 mm
0.1	0.001	0.003	0.004	0.01	0.004	0.01	0.003	0.004
265	3.2	7.2	11	15	10	16	8.7	11

US (imperial)

620 Sta-Pure, Chem-Sure, Neoprene, USGPM								
	620R				620RE		620RE4	
Speed rpm	6.4 mm	9.6 mm	12.7 mm	15.9 mm	12.0 mm	17.0 mm	12.0 mm	17.0 mm
0.1	0.0003	0.001	0.001	0.002	0.001	0.002	0.001	0.001
265	0.8	1.8	2.8	4.3	2.8	5.1	2.4	3.5

620 Marprene TL, Bioprene TL, USGPM								
	620R (standard)				620RE (standard)		620RE4 (standard)	
Speed rpm	6.4 mm	9.6 mm	12.7 mm	15.9 mm	12.0 mm	17.0 mm	12.0 mm	17.0 mm
0.1	0.0003	0.001	0.001	0.002	0.001	0.002	0.001	0.001
265	0.9	1.8	2.8	3.0	2.6	4.7	2.2	3.3

620 Marprene TM, Bioprene TM, USGPM				
	620RE (hard)		620RE4 (hard)	
Speed rpm	12.0 mm	17.0 mm	12.0 mm	17.0 mm
0.1	0.001	0.002	0.001	0.001
265	2.6	4.1	2.2	2.9

620 Pumpsil silicone, USGPM								
	620R				620RE		620RE4	
Speed rpm	6.4 mm	9.6 mm	12.7 mm	15.9 mm	12.0 mm	17.0 mm	12.0 mm	17.0 mm
0.1	0.0003	0.001	0.001	0.001	0.001	0.002	0.001	0.001
265	0.8	1.9	2.9	3.9	2.7	4.3	2.3	3.0

31 Continuous tubing product codes (620R)

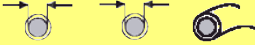
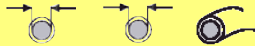
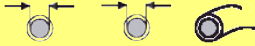
					
mm	inch	#	Marprene	Bioprene	Pumpsil silicone
6.4	1/4	26	902.0064.032	903.0064.032	913.0064.032
9.6	3/8	73	902.0096.032	903.0096.032	913.0096.032
12.7	1/2	82	902.0127.032	903.0127.032	913.0127.032
15.9	5/8	184	902.0159.032	903.0159.032	913.0159.032
					
mm	inch	#	Sta-Pure	Neoprene	PVC
6.4	1/4	26	960.0064.032	920.0064.032	950.0064.032
9.6	3/8	73	960.0096.032	920.0096.032	950.0096.032
12.7	1/2	82	960.0127.032	920.0127.032	950.0127.032
15.9	5/8	184	960.0159.032	920.0159.032	950.0159.032
					
mm	inch	#	Fluorel	Chem-Sure	
6.4	1/4	26	970.0064.032	965.0064.032	
9.6	3/8	73	970.0096.032	965.0096.032	
12.7	1/2	82	970.0127.032	965.0127.032	
15.9	5/8	184	970.0159.032	965.0159.032	

32 LoadSure tube element product codes (620RE and 620RE4)

	12mm Tri-clamp 3/4in	17mm Tri-clamp 3/4in	12mm Cam and Groove 3/4in	17mm Cam and Groove 3/4in
Sta-Pure	960.0120.PFT	960.0170.PFT		
Chem-Sure	965.0120.SST	965.0170.SST		
Bioprene TM	903.P120.PFT	903.P170.PFT		
Bioprene TL	903.0120.PFT	903.0170.PFT		
Pumpsil silicone	913.0120.PFT	913.0170.PFT		
Marprene TM			902.P120.PPC	902.P170.PPC
Marprene TL			902.0120.PPC	902.0170.PPC
Neoprene			920.0120.PPC	920.0170.PPC

Note: = for 4 bar use

33 620L and 620LG pumpheads

The twin offset track design of the 620L utilises 4.0mm wall double-Y tube elements to overcome pulsation for accurate dosing and dispensing. The 620L accepts Silicone and Marprene tubing up to 16.0mm bore.

Alternatively the 620L will run with two separate 4mm-wall tubes although some channel-to-channel variance and minimal pulsation may be experienced. For separate tube fitting or twin tube inlet to single tube outlet fitting tube clamping blocks must be used. See 33.8 620L pumphead spares.

33.1 620L and 620LG key safety information



Before opening the pumphead guard please ensure that the following safety directions are followed.

- Ensure that the pump is isolated from mains voltage.
- Ensure that there is no pressure in the pipeline.
- If a tube failure has occurred, ensure that any product in the pumphead has been allowed to drain.
- Ensure that protective clothing and eye protection are worn if hazardous products are being pumped.

33.2 620L and 620LG Guarding

- Primary safety on 620 series pumps is provided by the tool-lockable pumphead guard—in the case of the 620L and 620LG heads, the tool-lockable pumphead track functions as the guard. Secondary (backup) protection is provided in the form of an electrical guard switch which stops the pump if either end of the track is opened. The electrical guard switch on cased pumps should never be used as primary protection. Always disconnect the mains power supply to the pump before opening the pumphead.

33.3 620L and 620LG pumping conditions

Pressure and viscosity



Always isolate the pump from the mains power supply before opening the guard or performing any positioning, removal or maintenance.

- All pressure values in this operating instruction, from which performance and life figures have been calculated, relate to peak pipeline pressures.
- Although rated to 4 bar peak pressure, the 620LG may generate in excess of 4 bar working pressure if pipeline restrictions are in place. In instances where it is critical that a working pressure of 4 bar is not exceeded, pressure relief valves should be installed in the pipeline.

620L	0-2 bar	Y element or continuous tubing
620LG	0-4 bar	Sta-Pure and Chem-Sure Y elements only

- Ensure that there is always a minimum of one metre of smooth bore flexible tubing connected to the discharge port of the pumphead. This will help minimise any impulse losses and pulsation in the pipeline. This is especially important with viscous fluids and rigid pipework.

33.4 620L and 620LG removal and installation

A 620 pump supplied with a 620L pumphead is not intended for use with any other pumphead. However, the pumphead can be removed for cleaning or maintenance.



Always isolate the pump from the mains power supply before opening the guard or performing any positioning, removal or maintenance.



To remove the 620L pumphead

- To remove the pumphead you must first remove the track. The track is secured to the pumphead by cams positioned at its left and right. Where the cam shafts are visible at the front of the pumphead, they are milled square to accept a spanner. Use the 10mm or 3/8in AF spanner provided to rotate the right-hand cam shaft through 180 degrees counter-clockwise, and the left-hand camshaft through 180 degrees clockwise. The position of the cam rotation stops indicate when they are fully closed (third picture, left) and open (right). Lift off the track.
- The pumphead is secured to the black adaptor plate by two M6 screws. Use a 5mm Allen key to remove them. Lift off the pumphead.

It is not normally necessary to remove the adaptor plate. However, if it must be removed for cleaning:

- The adaptor plate is secured to the drive by four M6 screws. Use a suitable screwdriver to remove them. Lift off the adaptor plate. After cleaning, reposition and secure it in the same way.

To install the 620L pumphead

- Clean and grease the projecting dog of the drive shaft. Position the cleaned pumphead so that it engages with the drive-shaft dog. Use two M6 screws to secure the pumphead to the adaptor plate.
- Reverse the directions above to reposition the track.

33.5 620L and 620LG Tube loading

Double-Y elements for low-pulsation flow and dispensing applications

- See illustrations at 33.4 620L removal and installation. The track is secured to the pumphead by cams positioned at its left and right. Where the cam shafts are visible at the front of the pumphead, they are milled square to accept a spanner. Use a 10mm or 3/8in AF spanner to rotate the right-hand cam shaft through 180 degrees counter-clockwise, and the left-hand camshaft through 180 degrees clockwise. The position of the cam rotation stops indicate when they are fully closed (third picture, left) and open (right). Lift off the track.



- Locate one end of double-Y element over one of the 625L clamping pegs. Stretch the element over the rotor and locate the other end of the element over the second 625L clamping peg. Replace the track as described at 33.4 620L removal and installation.

Twin inlet tubes for best handling of viscous fluids

- See illustrations at 33.4 620L removal and installation. The track is secured to the pumphead by cams positioned at its left and right. Where the cam shafts are visible at the front of the pumphead, they are milled square to accept a spanner. Use a 10mm or 3/8in AF spanner to rotate the right-hand cam shaft through 180 degrees counter-clockwise, and the left-hand camshaft through 180 degrees clockwise. The position of the cam rotation stops indicate when they are fully closed (third picture, left) and open (right). Lift off the track.



- Unscrew and remove the 625L inlet clamping peg. Connect the twin inlet tubes and outlet tube using the appropriate Y-piece connector and clips. Fit the inlet tubes into the correct size clamping block. Locate the Y-piece end of the ele-

ment over the 625L clamping peg. Stretch the tubes and screw the clamping block into place. Replace the track as described at 33.4 620L removal and installation.

Two independent tubes for twin-channel pumping

- See illustrations at 33.4 620L removal and installation. The track is secured to the pumphead by cams positioned at its left and right. Where the cam shafts are visible at the front of the pumphead, they are milled square to accept a spanner. Use a 10mm or 3/8in AF spanner to rotate the right-hand cam shaft through 180 degrees counter-clockwise, and the left-hand camshaft through 180 degrees clockwise. The position of the cam rotation stops indicate when they are fully closed (third picture, left) and open (right). Lift off the track.

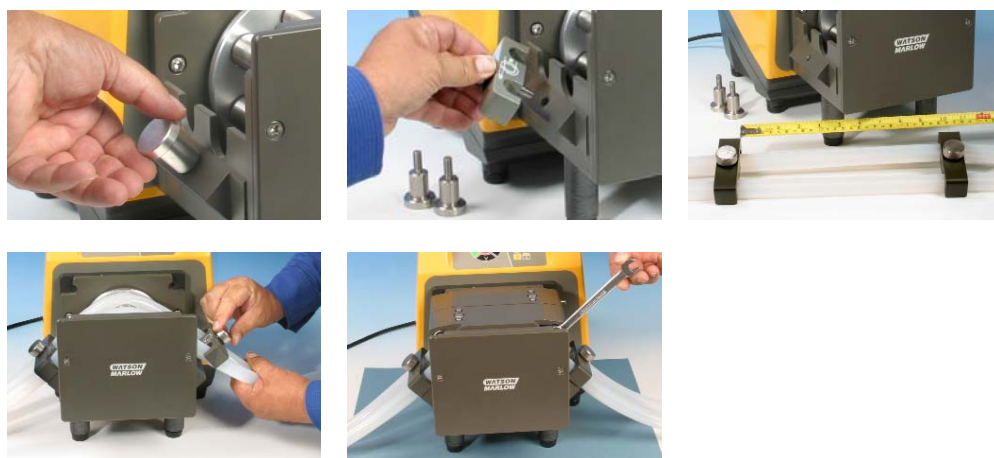

- Unscrew and remove the 625L clamping pegs. Clamping blocks will be used to secure the continuous tube, using the same screw sockets. Fit the two tubes into the correct size clamping blocks. Distance between blocks = 230mm for up to 8.0mm bore; 240mm for 12.0mm and 16.0mm bore. Fit the inlet tube clamping block to the 625L. Stretch the tubes over the rotor and fit the second tube clamping block to the 625L. Replace the track as described at 33.4 620L removal and installation. When using Marprene it is important to check the tube length after 30 minutes running time.

33.6 620L and 620LG care and maintenance

Check all moving parts for freedom of movement occasionally. If aggressive fluids are spilt onto the pumphead, clean using a mild detergent only.

33.7 620L and 620LG track adjustment

The track is set for 4.0mm wall tubing up to 16.0mm bore. Alteration of this setting using the pan head screws may be necessary to optimise performance if non-standard tubing is used. **However, the pump warranty will be invalidated if this is done.** The factory setting is 20.3mm vertically from the rotor side of the sprung track to the top of the track cover.

33.8 620L and 620LG Pumphead spares

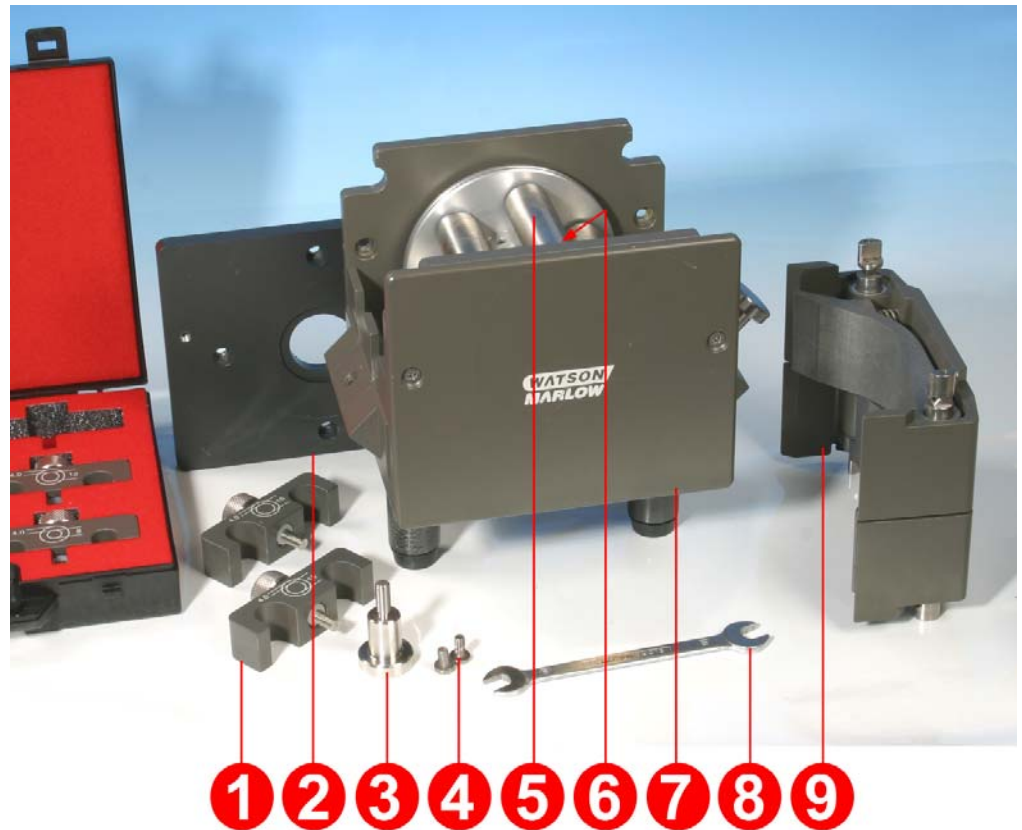

Number	Spare	Description
	MRA3021A	620L pumphead
	MRA3022A	620LG pumphead
1	069.4001.000	Tube clamp set
2	MR3017S	Adaptor plate
3	MRA0144A	Tube locating peg
4	FN0493	M6x12 screws x 6
5	MRA0150A	Rotor assembly
6	BB0018	Shaft bearing
7	MR0850S	Front plate
8	TT0005	10mm / 3/8in spanner
9	MRA3020A	Track assembly
	MR3002	Foot

34 620L and 620LG performance data

Sta-Pure and Marprene™ tubing are hard to compress when new. When using tubing made of these materials, the first five pumphead revolutions should be at a speed of 10rpm or greater. If the pump is run slower, the safety system built into pump drive's software may cause it to stop and display an over-current error message.

34.1 620L and 620LG flow rates

Note: Rates apply to Y elements and two channels of continuous tubing combined.

620L flow rates (2 bar pressure capacity)

620L, Neoprene, l/min				620L, Neoprene, USGPM			
Speed rpm	Tube bore (4.0mm wall)			Speed rpm	Tube bore (4.0mm wall)		
	8.0mm	12.0mm	16.0mm		8.0mm	12.0mm	16.0mm
0.1	0.002	0.003	0.005	0.1	0.0005	0.0008	0.0013
265	4.6	7.7	13.3	265	1.20	2.03	3.50

620L, Marprene, Bioprene, l/min				620L, Marprene, Bioprene, USGPM			
Speed rpm	Tube bore (4.0mm wall)			Speed rpm	Tube bore (4.0mm wall)		
	8.0mm	12.0mm	16.0mm		8.0mm	12.0mm	16.0mm
0.1	0.002	0.003	0.004	0.1	0.0004	0.0008	0.0011
265	4.5	8.0	11.3	265	1.18	2.12	2.98

620L, Pumpsil silicone, l/min				620L, Pumpsil silicone, USGPM			
Speed rpm	Tube bore (4.0mm wall)			Speed rpm	Tube bore (4.0mm wall)		
	8.0mm	12.0mm	16.0mm		8.0mm	12.0mm	16.0mm
0.1	0.002	0.003	0.004	0.1	0.0004	0.0008	0.0011
265	4.4	8.5	11.5	265	1.17	2.25	3.05

620LG flow rates (4 bar pressure capacity)

620L, Sta-Pure, ChemSure, l/min				620L, Sta-Pure, ChemSure, USGPM			
Speed rpm	Tube bore (4.0mm wall)			Speed rpm	Tube bore (4.0mm wall)		
	8.0mm	12.0mm	16.0mm		8.0mm	12.0mm	16.0mm
0.1	0.002	0.003	0.005	0.1	0.0005	0.0009	0.0012
165	3.1	5.7	7.8	165	0.81	1.52	2.05
265	5.2	9.0	12.4	265	1.39	2.38	3.28

34.2 620L tubing codes

Marprene		Dispensing information	
		Bore	Litres/rev
902.E080.K40	Y element	8.0mm	0.01689
902.E120.K40		12.0mm	0.03029
902.E160.040		16.0mm	0.04251
902.0080.040	Continuous	8.0mm	0.01689
902.0120.040		12.0mm	0.03029
902.0160.040		16.0mm	0.04251

Bioprene		Dispensing information	
		Bore	Litres/rev
903.E080.040	Y element	8.0mm	0.01689
903.E120.040		12.0mm	0.03029
903.E160.040		16.0mm	0.04251
903.0080.040	Continuous	8.0mm	0.01689
903.0120.040		12.0mm	0.03029
903.0160.040		16.0mm	0.04251

Pumpsil silicone		Dispensing information	
		Bore	Litres/rev
913.AE80.K40	Y element	8.0mm	0.01672
913.A12E.K40		12.0mm	0.03214
913.A16E.040		16.0mm	0.04353
913.A080.040	Continuous	8.0mm	0.01672
913.A120.040		12.0mm	0.03214
913.A160.040		16.0mm	0.04353

Neoprene		Dispensing information	
		Bore	Litres/rev
920.E080.K40	Y element	8.0mm	0.01721
920.E120.K40		12.0mm	0.02901
920.E160.040		16.0mm	0.05004
920.0080.040	Continuous	8.0mm	0.01721
920.0120.040		12.0mm	0.02901
920.0160.040		16.0mm	0.05004

34.3 620LG element codes

Sta-Pure		Dispensing information	
		Bore	Litres/rev
960.E080.K40	Y element	8.0mm	0.01979
960.E120.K40		12.0mm	0.03349
960.E160.040		16.0mm	0.04689

Chem-Sure		Dispensing information	
		Bore	Litres/rev
965.E080.K40	Y element	8.0mm	0.01979
965.E120.K40		12.0mm	0.03349
965.E160.040		16.0mm	0.04689

DuN, Du

35 620 series pumping accessories

Accessory	Description	Part code	Pump compatibility
520AF	Footswitch with 25-pin D-connector	059.3002.000	620U, 620Du, 620Di
624AF	Footswitch, bare lead	069.5231.000	620UN, 620DuN, 620DiN
520AH	Handswitch with 25-pin D-connector	059.3022.000	620U, 620Du, 620Di
520ANC	Network cable, RS232, with 9-pin D-connectors	059.3121.000	620Du, 620Di
520ANX	Network extension cable with 9-pin D-connectors	059.3122.000	620Du, 620Di
520ANA	Network adaptor, 25-pin to 9-pin D-connector	059.3123.000	
520AB	Batch records cable with 9-pin D-connectors	059.3125.000	620Di
624AV	Proximity switch for 624AS filling stand	069.5271.000	620UN, 620DuN, 620DiN
624AS	Stainless steel filling stand for 624AFN filling needles	069.5001.000	All models
624AFN	Filling needle set (3 sizes)	069.5101.000	All models
	Filling needle for 8.0mm bore tubing	069.5100.080	All models
	Filling needle for 12.0mm bore tubing	069.5100.120	All models
	Filling needle for 16.0mm bore tubing	069.5100.160	All models
624AL	Dispensing lance for use with 624AFN filling needles	069.5251.000	All models
	Tube monitor with 25-pin D-connector	059.4501.520	620U, 620Du, 620Di
	Tube monitor, bare lead	059.450N.520	620UN, 620DuN, 620DiN
620AL	Leak detector kit, bare lead	069.7131.000	620UN, 620DuN, 620DiN

DuN, Du

36 Trademarks

Watson-Marlow, Bioprene, Pumpsil and Marprene are trademarks of Watson-Marlow Limited. Tygon is a trademark of the Saint Gobain Performance Plastics Company.

Fluorel is a trademark of 3M.

Sta-Pure and Chem-Sure are trademarks of W.L.Gore and Associates.

DuN, Du

37 Warning not to use pumps in patient-connected applications

Warning: These products are not designed for use in, and should not be used for patient-connected applications.

DuN, Du

38 Publication history

m-620dun-du-gb-02.qxp: Watson-Marlow 620Du, 620DuN

First published 10 05.

39 Decontamination certificate

In compliance with the UK Health and Safety at Work Act and the Control of Substances Hazardous to Health Regulations, you are required to declare the substances which have been in contact with product(s) you return to Watson-Marlow or its subsidiaries or distributors. Failure to do so will cause delays. Please ensure that you fax us this form and receive an RGA (Returned Goods Authorisation) before you despatch the product(s). A copy of this form must be attached to the outside of the packaging containing the product(s). Please complete a separate decontamination certificate for each product. You are responsible for cleaning and decontaminating the product(s) before return.

Your name	<input type="text"/>	Company	<input type="text"/>
Address	<input type="text"/>		
Postcode/zip	<input type="text"/>	Country	<input type="text"/>
Telephone	<input type="text"/>	Fax	<input type="text"/>
Product type	<input type="text"/>	Serial number	<input type="text"/>
To speed the repair, please describe all known faults	<input type="text"/>		
The product has ...	<input type="checkbox"/> Been used <input type="checkbox"/> Not been used		
	<i>If the product has been used, please complete all the following sections. If the product has not been used, please just sign this form.</i>		
Names of chemicals handled with product(s)	<input type="text"/>		
Precautions to be taken in handling these chemicals	<input type="text"/>		
Action to be taken in the event of human contact	<input type="text"/>		
	<i>I understand that the personal data collected will be kept confidentially in accordance with the UK Data Protection Act 1998.</i>		
Signature	<input type="text"/>	RGA number	<input type="text"/>
		Your position	<input type="text"/>
		Date	<input type="text"/>
<i>Please print out, sign and fax to Watson-Marlow Pumps at +44 1326 376009.</i>			