

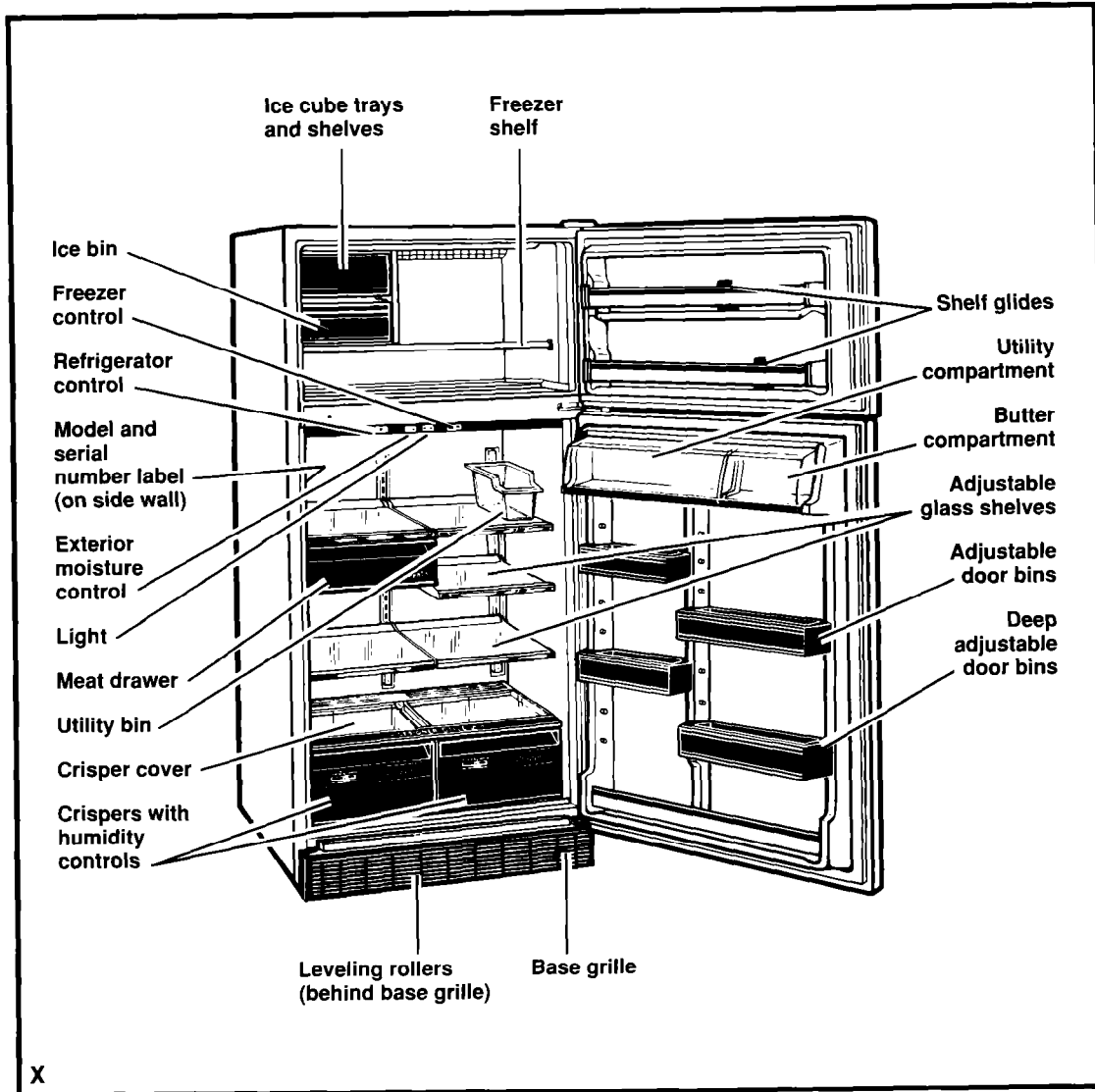

# Use & Care Guide



**NO-FROST  
REFRIGERATOR-FREEZERS  
3ET18DK 3ET18RK 6ET18RK**

9-92

# Contents

	Page
<b>Important Safety Instructions</b> .....	3
<b>Before Using Your Refrigerator</b> .....	4
<b>Using Your Refrigerator</b> .....	5
Setting the controls .....	5
Changing the control settings .....	5
Exterior moisture control .....	6
Adjusting the refrigerator shelves .....	6
Adjusting the shelf and bin glides .....	6
Adjusting the door bins .....	7
Removing the crispers and crisper cover .....	7
Adjusting the crisper humidity control .....	7
Removing the meat drawer and cover .....	8
Changing the light bulbs .....	8
Removing the base grille .....	9
Reversing the door swing .....	9
Ice compartment door .....	9
Ice cube trays .....	9
Sounds you may hear .....	10
Energy saving tips .....	10
<b>Cleaning Your Refrigerator</b> .....	11
<b>Food Storage Guide</b> .....	12
Storing fresh food .....	12
Storing frozen food .....	12
<b>Caring For Your Refrigerator</b> .....	13
Holiday and moving care .....	13
Power interruptions .....	13
<b>If You Need Service Or Assistance</b> .....	14
<b>Whirlpool Refrigerator Warranty</b> .....	16

© 1992 Whirlpool Corporation

Remove the consumer Buy Guide Label, tape and any inside labels (except model and serial number label) before using the refrigerator.

**To remove any remaining glue:**

- Rub briskly with thumb to make a ball, then remove.

**OR**

- Soak area with liquid hand dishwashing detergent before removing glue as described above. Do not use sharp instruments, rubbing alcohol, flammable fluids or abrasive cleaners. These can damage the material. See "Important Safety Instructions" on page 3.

**NOTE:** Do not remove any permanent instruction labels inside your refrigerator. Do not remove the Tech Sheet fastened under the refrigerator at the front.

**Thank you for buying a Whirlpool appliance.** Please complete the form below. Have this information ready if you need service or call with a question.

- Copy model and serial numbers from label (see diagram on front cover) and purchase date from sales slip.
- Keep this book and sales slip together in a handy place.

---

**Model Number**

---

**Serial Number**

---

**Purchase Date**

---

**Service Company Phone Number**

# Important Safety Instructions

## **⚠ WARNING**

To reduce the risk of fire, electrical shock or injury when using your refrigerator, follow basic precautions including the following:

- Read all instructions before using the refrigerator.
- Child entrapment and suffocation are not problems of the past. Junked or abandoned refrigerators are still dangerous ... even if they will "just sit in the garage a few days."  
If you are getting rid of your old refrigerator, do it safely. Please read the enclosed safety booklet from the Association of Home Appliance Manufacturers. Help prevent accidents.
- Never allow children to operate, play with, or crawl inside the refrigerator.
- Never clean refrigerator parts with flammable fluids. The fumes can create a fire hazard or explosion.

• FOR YOUR SAFETY •

**DO NOT STORE OR USE GASOLINE OR OTHER FLAMMABLE VAPORS AND LIQUIDS IN THE VICINITY OF THIS OR ANY OTHER APPLIANCE. THE FUMES CAN CREATE A FIRE HAZARD OR EXPLOSION.**

**It is your responsibility to be sure your refrigerator:**

- is installed and leveled on a floor that will hold the weight, and in an area suitable for its size and use.
- is connected only to the proper kind of outlet, with the correct electrical supply and grounding.
- is used only to do what home refrigerators are designed to do.
- is not near an oven, radiator or other heat source.
- is properly maintained.
- is out of the weather.
- is used in an area where the room temperature will not fall below 13°C (55°F).
- is not used by anyone unable to operate it properly.
- is not loaded with food before it has time to get properly cold.

– SAVE THESE INSTRUCTIONS –

**IMPORTANT SAFETY INSTRUCTIONS**

# Before Using Your Refrigerator

## Clean it

Clean your refrigerator before using it. See cleaning instructions on page 11.

## Plug it in

### Recommended Grounding Method

A 220 or 240 Volt, 50 Hz., AC only 15 or 20 ampere fused and properly grounded electrical supply is required. It is recommended that a separate circuit serving only this appliance be provided. Use a receptacle which cannot be turned off with a switch or pull chain. Do not use an extension cord.

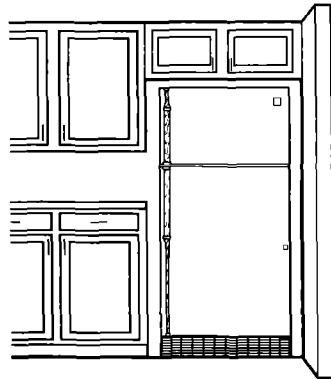
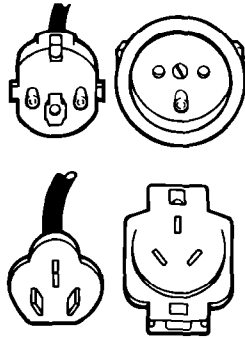

## Install properly

1. Allow 1.25 cm (½ inch) space on each side and at the top of the refrigerator for ease of installation.
2. If the refrigerator is to be against a wall, you might want to leave extra space on the hinge side closest to the wall so the door can be opened wider.
3. The refrigerator back can be flush against the wall.

## Level refrigerator-freezer

1. Remove the base grille. (See page 9.)
2. To raise front, turn screw in direction shown.
3. To lower front, turn screw in direction shown.
4. Check with level.
5. Replace base grille. (See page 9.)

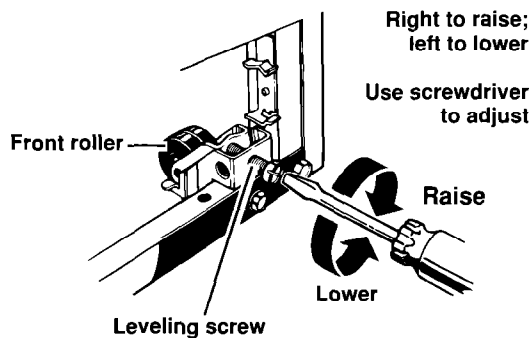

# Using Your Refrigerator

**BEFORE USING YOUR REFRIGERATOR • USING YOUR REFRIGERATOR**

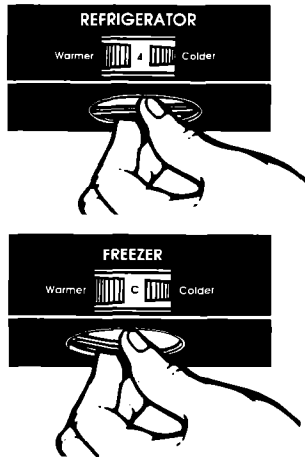

## Setting the controls

Controls for the refrigerator and freezer are in the refrigerator. To adjust a control, turn knob. When the refrigerator is plugged in for the first time:

1. Set the refrigerator Control to 4.

2. Set the Freezer Control to C.

Give the refrigerator time to cool down completely before adding food. (This may take several hours.)

These settings should be right for normal household refrigerator usage.

The controls will be set about right when milk or juice is as cold as you like and when ice cream is firm.

Refrigerator Control adjustments range from 1 to 8. Freezer Control adjustments range from A to D.

## Changing the control settings

If you need to adjust temperatures in refrigerator or freezer, use the settings listed in the chart below as a guide.

- Adjust the Refrigerator Control first.
- Wait at least 24 hours between adjustments.
- Then adjust the Freezer Control if needed.

CONDITION:	REASON:	RECOMMENDED CONTROL SETTINGS:	
If Refrigerator Section is TOO WARM	Door opened often Large amount of food added Room temperature too warm	Refrigerator Freezer	6 D
If Freezer Section is TOO WARM	Door opened often Large amount of food added Very cold room temperature (can't cycle often enough)	Refrigerator Freezer	4 A
If Refrigerator Section is TOO COLD	Controls not set correctly for your conditions	Refrigerator Freezer	2 A
If ICE isn't MADE FAST ENOUGH	Heavy ice usage Very cold room temperature (can't cycle often enough)	Refrigerator Freezer	4 A
If BOTH SECTIONS are TOO WARM	Door opened often Large amount of food added Very warm or very cold room temperatures	Refrigerator Freezer	6 C

## Using Your Refrigerator Continued

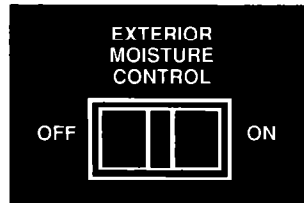

Glass shelves  
are heavy. Be  
careful.

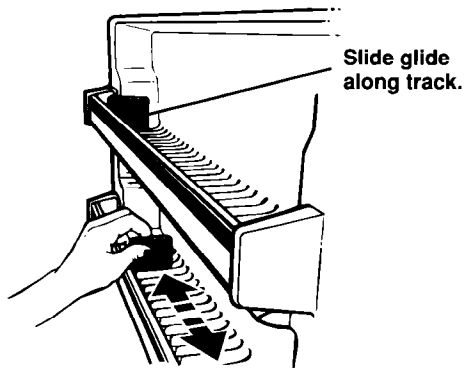
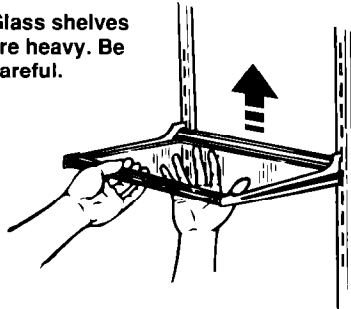

### Exterior moisture control

The Exterior Moisture Control on the Control Console operates electric heaters around the door openings. These heaters help keep moisture from forming on the outside of the refrigerator.

1. Use the OFF setting when humidity is low.
2. Use the ON setting if moisture forms on the outside of the refrigerator.

### Adjusting the refrigerator shelves

Shelves can be adjusted to match the way you use your refrigerator. Glass shelves are strong enough to hold bottles, milk and other heavy food items.

#### To remove shelves:

1. Remove items from shelf.
2. Tilt up at front.
3. Lift up at back.
4. Pull shelf straight out.

#### To replace shelves:

1. Guide the rear hooks into the slots in the shelf supports.
2. Tilt up front of shelf until hooks drop into slots. Lower front of shelf to level position.

### Adjusting the shelf and bin glides

The shelf or bin glides can be used to secure odd shaped items or to separate other items.

1. Grasp glide.
2. Slide glide along track.

Shelf glides cannot be removed.

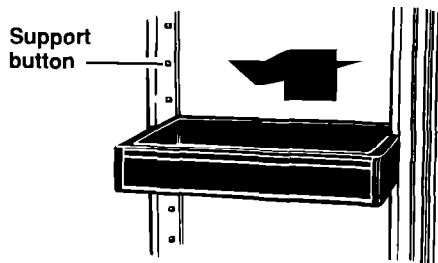

### Adjusting the door bins

#### To remove:

1. Lift bin up.
2. Pull bin straight out.

#### To replace:

1. Slide bin in above desired support button.
2. Push bin down until it stops.

Pull out to the stop, lift the front and pull again.

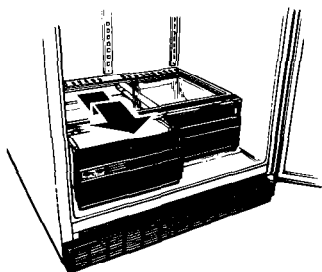

### Removing the crispers and crisper cover

#### To remove the crispers:

1. Slide crisper straight out to the stop.
2. Lift the front.
3. Slide out the rest of the way.
4. Replace in reverse order.

Lift the cover front, then the back.

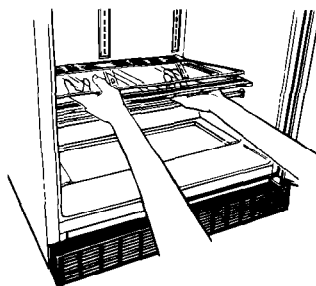

#### To remove the cover:

1. Push up glass insert from bottom, then slide out with both hands.
2. Lift front of cover frame.
3. Lift out cover frame by pulling up and out.
4. Remove metal cover support.

#### To replace the cover:

1. Replace metal cover support on wall supports in front section of cabinet.
2. Fit back of cover frame into notch supports on walls of refrigerator, then lower into place.
3. Slide back of glass insert into place, then lower front.

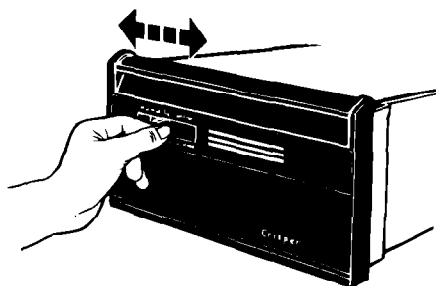

### Adjusting the crisper humidity control

You can control the amount of humidity in the moisture-sealed crisper.

- The control can be adjusted to any setting between LOW and HIGH.
- LOW (open) lets moist air out of the crisper for best storage of fruits and vegetables with skins.
- HIGH (closed) keeps moist air in the crisper for best storage of fresh, leafy vegetables.

## Using Your Refrigerator Continued

Pull out to the stop, lift  
the front and pull again.

Glass is heavy.  
Be careful.

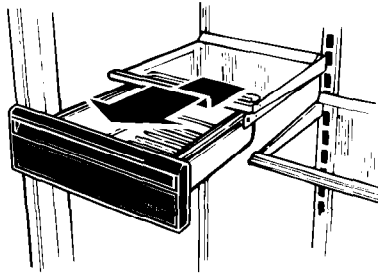

### Removing the meat drawer and cover

#### To remove the meat drawer:

1. Slide the meat drawer out to the stop.
2. Lift the front.
3. Slide the drawer out the rest of the way.
4. Replace in reverse order.

#### To remove the cover:

1. Tilt front of cover up, lift at back, and pull straight out.
2. Replace in reverse order.

### Changing the light bulbs

#### **⚠ WARNING**

##### **Electrical Shock Hazard**

**Before removing a light bulb, either unplug the refrigerator or disconnect the electricity leading to the refrigerator at the main power supply. Failure to do so could result in electrical shock or personal injury.**

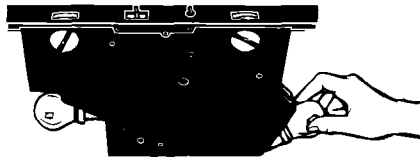

#### To change refrigerator light:

1. Disconnect refrigerator from power supply.
2. Reach behind Control Console to find bulbs.
3. Remove bulb.
4. Replace with a 40-watt appliance bulb.
5. Reconnect power supply.

**NOTE:** Not all appliance bulbs will fit your refrigerator. Be sure to replace bulb with one of the same size and shape.



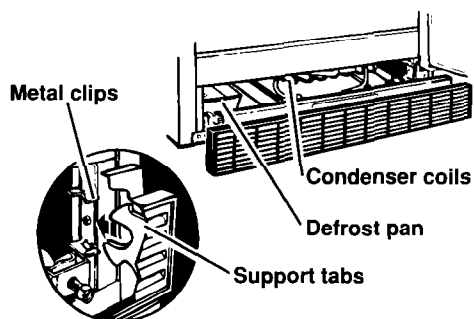

### Removing the base grille

#### To remove the grille:

1. Open the freezer door.
2. Pull grille out.
3. **Do not remove Tech Sheet** fastened behind grille.

#### To replace grille:

1. Line up grille support tabs with metal clips.
2. Push firmly to snap into place.
3. Close the door.

See cleaning instructions for defrost pan and condenser coils on page 11.

### Reversing the door swing

You can change the hinges on your refrigerator so the doors open the other way. Refer to the instruction sheet included with your refrigerator.

### Ice compartment door

Pull the ice compartment door panel out from the bottom and slide it to the rear.

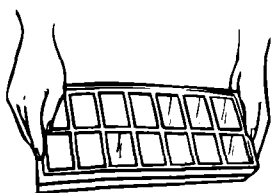
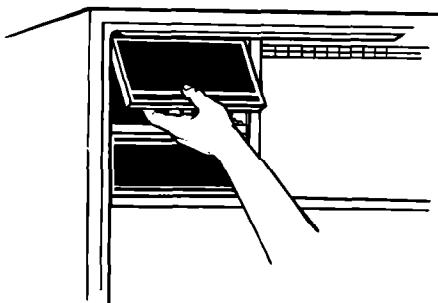

### Ice cube trays

If cubes are not used, they may shrink. The moving cold air starts a slow evaporation. The longer cubes are stored, the smaller they get.

#### To remove ice:

1. Hold tray at both ends.
2. Twist slightly.

## Using Your Refrigerator Continued

### Sounds you may hear

Your new refrigerator may make sounds that your old one didn't. Because the sounds are new to you, you might be concerned about them. Don't be. Most of the new sounds are normal. Hard surfaces like the floor, walls and cabinets can make the sounds seem louder.

The following describes the kinds of sounds that might be new to you, and what may be making them.

#### **Slight hum, soft hiss:**

You may hear the refrigerator's fan motor and moving air.

#### **Clicking or snapping sounds:**

The thermostat makes a definite click when the refrigerator stops running. It also makes a sound when the refrigerator starts running. The defrost timer will click when the defrost cycle starts.

#### **Water sounds:**

When the refrigerator stops running, you may hear gurgling in the tubing for a few minutes after it stops. You may also hear defrost water running into the defrost water pan.

#### **Running sounds:**

Your refrigerator has a high-efficiency compressor and motor. It will run longer than older designs. It may even seem to run most of the time.

### Energy saving tips

You can help your refrigerator use less electricity.

- Check door gaskets for a tight seal. Level the cabinet to be sure of a good seal.
- Clean the condenser coils regularly.
- Open the door as few times as possible. Think about what you need before you open the door. Get everything out at one time. Keep food organized so you won't have to search for what you want. Close door as soon as food is removed.
- Go ahead and fill up the refrigerator, but don't overcrowd it so air movement is blocked.
- It is a waste of electricity to set the refrigerator and freezer to temperatures colder than they need to be. If ice cream is firm in the freezer and drinks are as cold as your family likes them, that's cold enough.
- Keep the Exterior Moisture Control in the OFF position unless moisture forms on refrigerator exterior.
- Make sure your refrigerator is not next to a heat source such as a range, water heater, furnace, radiator or in direct sunlight.

# Cleaning Your Refrigerator

Both the refrigerator and freezer sections defrost automatically. But both should be cleaned about once a month to help prevent odors from building up. Spills should be wiped up right away.

To clean your refrigerator, turn the Refrigerator Control to OFF, unplug it, take out all removable parts and clean the refrigerator according to the following directions.

PART	WHAT TO USE	HOW TO CLEAN
<b>Removable parts</b> (shelves, crispers, meat drawer, etc.)	<ul style="list-style-type: none"> <li>• Sponge or cloth</li> <li>• Mild detergent</li> <li>• Warm water</li> </ul>	<ul style="list-style-type: none"> <li>• Wash removable parts by hand.</li> <li>• Rinse and dry thoroughly.</li> </ul>
<b>Outside</b>	<ul style="list-style-type: none"> <li>• Sponge, cloth or paper towel</li> <li>• Mild detergent</li> <li>• Warm water</li> <li>• Appliance wax (or good auto paste wax)</li> </ul>	<ul style="list-style-type: none"> <li>• Wash outside of cabinet. <b>Do not use abrasive or harsh cleaners.</b></li> <li>• Rinse and dry thoroughly.</li> <li>• Wax painted metal surfaces at least twice a year. Apply wax with a clean, soft cloth. <b>Waxing painted metal surfaces provides rust protection. Do not wax plastic parts.</b></li> </ul>
<b>Inside walls</b> (freezer should be allowed to warm up so cloth won't stick)	<ul style="list-style-type: none"> <li>• Sponge, soft cloth or paper towel</li> <li>• Baking soda or mild detergent</li> <li>• Warm water</li> </ul>	<ul style="list-style-type: none"> <li>• Wash with mixture of warm water and –mild detergent, or –baking soda (26 g [2 tablespoons] to 0.95 L [1 quart] of water).</li> <li>• Rinse and dry thoroughly.</li> </ul>
<b>Door liners and gaskets</b>	<ul style="list-style-type: none"> <li>• Sponge, soft cloth or paper towel</li> <li>• Mild detergent</li> <li>• Warm water</li> </ul>	<ul style="list-style-type: none"> <li>• Wash.</li> <li>• Rinse and dry thoroughly. <b>DO NOT USE cleaning waxes, concentrated detergents, bleaches or cleaners containing petroleum on plastic parts.</b></li> </ul>
<b>Plastic parts</b> (covers and panels)	<ul style="list-style-type: none"> <li>• Soft, clean sponge or soft, clean cloth</li> <li>• Mild detergent</li> <li>• Warm water</li> </ul>	<ul style="list-style-type: none"> <li>• Wash</li> <li>• Rinse and dry thoroughly. <b>DO NOT USE paper towels, window sprays, scouring cleansers or flammable fluids. These can scratch or damage material. See "Important Safety Instructions" on page 3.</b></li> </ul>
<b>Defrost pan</b>	<ul style="list-style-type: none"> <li>• Sponge or cloth</li> <li>• Mild detergent</li> <li>• Warm water</li> </ul>	<ul style="list-style-type: none"> <li>• Remove base grille. (See page 9.)</li> <li>• To remove defrost pan, lift pan over wire brace (remove tape, if any).</li> <li>• Wash defrost pan.</li> <li>• Rinse and dry thoroughly.</li> <li>• Replace with notched corner to the rear. Push it in all the way.</li> <li>• Make sure defrost drain tube is pointing into pan.</li> <li>• Replace base grille.</li> </ul>
<b>Condenser coils</b>	<ul style="list-style-type: none"> <li>• Vacuum cleaner with extended narrow attachment</li> </ul>	<ul style="list-style-type: none"> <li>• Remove base grille.</li> <li>• Vacuum coils (at least every other month).</li> <li>• Replace base grille.</li> </ul>
<b>Floor under refrigerator</b>	<ul style="list-style-type: none"> <li>• Floor cleaners</li> </ul>	<ul style="list-style-type: none"> <li>• Roll refrigerator out away from the wall.</li> <li>• Clean floor.</li> <li>• Roll refrigerator back into place.</li> <li>• Check to see if the refrigerator is level.</li> </ul>

USING YOUR REFRIGERATOR • CLEANING YOUR REFRIGERATOR

# Food Storage Guide

There is a correct way to package and store refrigerated or frozen food. To keep food fresher, longer, take the time to study these recommended steps.

## Storing fresh food

Food placed in the refrigerator should be wrapped or stored in air and moisture proof material. This prevents food odor and taste transfer throughout the refrigerator. For dated products, check code date to ensure freshness.

### Leafy vegetables

Remove store wrapping and trim or tear off bruised and discolored areas. Wash in cold water and drain. Place in plastic bag or plastic container and store in crisper.

### Vegetables with skins (carrots, peppers)

Store in crisper, plastic bags or plastic container.

### Fruit

Wash, let dry and store in refrigerator in plastic bags or crisper. Do not wash or hull berries until they are ready to use. Sort and keep berries in their store container in a crisper, or store in a loosely closed paper bag on a refrigerator shelf.

### Meat

Most meat can be stored in original wrapping as long as it is air and moisture proof. Rewrap if necessary. See the following chart for storage times.

### Storage chart for fresh and cured meat\*

TYPE	APPROXIMATE TIME (DAYS)
Chicken .....	1 to 2
Ground beef .....	1 to 2
Steaks and roasts .....	3 to 5
Cured meats .....	7 to 10
Bacon .....	5 to 7
Cold cuts .....	3 to 5
Variety meats .....	1 to 2

\*If meat is to be stored longer than the times given, follow the directions for freezing.

**NOTE:** Fresh fish and shellfish should be used the same day as purchased.

### Eggs

Store without washing in the original carton on interior shelf.

### Milk

Wipe milk cartons. For best storage, place milk on interior shelf.

### Butter or margarine

Keep opened butter in covered dish or closed compartment. When storing an extra supply, wrap in freezer packaging and freeze.

### Cheese

Store in the original wrapping until you are ready to use it. Once opened, rewrap tightly in plastic wrap or aluminum foil.

### Leftovers

Cover leftovers with plastic wrap or aluminum foil. Plastic containers with tight lids can also be used.

## Storing frozen food

The freezer section is designed for storage of commercially frozen food and for freezing food at home. For further information about preparing food for freezing, contact your local Cooperative Extension Service or check a freezer guide or cookbook.

### Packaging

The secret of successful freezing is in the packaging. The way you close and seal the package must not allow air or moisture in or out. Packaging done in any other way could cause food odor and taste transfer throughout the refrigerator and drying of frozen food.

Rigid polyethylene (plastic) containers with tight fitting lids, straight-sided canning/freezing jars, heavy-duty aluminum foil, plastic-coated paper and nonpermeable plastic wraps (made from a saran film) are recommended. Follow package or container instructions for proper freezing methods.

### Do not use:

- Bread wrappers
- Non-polyethylene plastic containers
- Containers without tight lids
- Waxed paper
- Waxed-coated freezer wrap
- Thin, semi-permeable wrap

The use of these wrappings could cause food odor, taste transfer and drying of frozen food.

### Freezing

Do not expect your freezer to quick-freeze any large quantity of food. Put no more unfrozen food into the freezer than will freeze within 24 hours. (No more than 0.9 to 1.4 kg [2 to 3 pounds] of food per cubic foot of freezer space.) Leave enough space for air to circulate around packages. Be careful to leave enough room at the front so the door can close tightly.

Storage times will vary according to the quality of the food, the type of packaging or wrap used (air and moisture proof), and the storage temperature which should be -17.8°C (0°F). For further information about food storage times, contact your local Cooperative Extension Service or check a freezer guide or cookbook.

# Caring For Your Refrigerator

## Holiday and moving care

### Short holidays

No need to shut off the refrigerator if you will be away for less than four weeks. Use up perishables; freeze other items.

### Long holidays

Remove all the food if you are going for a month or more.

Unplug the refrigerator and clean it ... rinse well and dry. Tape rubber or wood blocks to the tops of both doors ... keeping them open far enough for air to get in. This will keep odor and mold from building up.

## **⚠ WARNING**

### **Personal Injury Hazard**

**Do not allow children to climb on, play near or climb inside the refrigerator when the doors are blocked open. They may become injured or trapped.**

To restart refrigerator, see "Using Your Refrigerator" on page 5.

### Moving

Remove all food. Pack frozen food in dry ice. Unplug the refrigerator and clean it thoroughly.

Take out all removable parts. Wrap all parts well and tape them together so they don't shift and rattle. Screw in the leveling rollers; tape the doors shut; and tape the electric cord to the cabinet.

When you get to your new home, put everything back and refer to page 4.

## Power interruptions

If electricity goes off, call the power company. Ask how long power will be off.

1. If service is to be interrupted 24 hours or less, **keep both doors closed**. This will help foods stay frozen.
2. If service is to be interrupted longer than 24 hours:
  - (a) Remove all frozen food and store in a frozen food locker.

### **OR**

- (b) Place 0.9 kg (2 lbs.) of dry ice in freezer for every cubic foot of freezer space. This will keep food frozen for 2 to 4 days. Wear gloves to protect your hands from dry ice burns.
  - (c) If neither a food locker or dry ice is available, use or can perishable food at once.
3. A full freezer will stay cold longer than a partly filled one. A freezer full of meat will stay cold longer than a freezer full of baked goods. If food contains ice crystals, it may be safely refrozen, although the quality and flavor may be affected. If the condition of the food is poor or if you feel it is unsafe, dispose of it.

# If You Need Service Or Assistance

## We suggest you follow these steps:

### 1. Before calling for assistance ...

Performance problems often result from little things you can find and fix yourself without tools of any kind.

#### If your refrigerator will not operate:

- Is the power supply cord plugged into a live circuit with proper voltage? (See page 4.)
- Have you checked your home's main fuses or circuit breaker box?
- Is the Refrigerator Control ON?

#### If there is a rattling or jingling noise or unfamiliar sounds:

- Is something on top of or behind the refrigerator making noise when the refrigerator is running?
- New features on your new refrigerator make new sounds. You may be hearing air flowing from the fans, timer clicks for the defrost cycle, or defrost water draining in the defrost pan.

#### If there is water in the defrost pan:

- This is normal in hot, muggy weather. The pan can even be half full. Make sure the refrigerator is level so the pan does not overflow.

#### If the light does not work:

- Have you checked your home's main fuses or circuit breaker box?
- Is the power supply cord plugged in to a live circuit with the proper voltage? (See page 4.)

#### If a bulb is burned out:

- See instructions for changing light bulbs on page 8. Use appliance bulbs only.

#### If the motor seems to run too much:

- Is the condenser free of dust and lint?
- On hot days, or if the room is warm, the motor naturally runs longer.
- If the door has been opened a lot, or if a large amount of food has been put in, the motor will run longer to cool down the interior.

### Remember:

Motor running time depends on different things: number of door openings, amount of food stored, temperature of the room, setting of the controls.

Your new refrigerator may be larger than your old one so it has more space to be cooled. It also has a regular freezer instead of a frozen food compartment. All this means better refrigeration and may require more running time than your old one.

### 2. If the problem is not due to one of the above items\* ...

Contact the dealer from whom you purchased the unit or an authorized Whirlpool<sup>SM</sup> service company.

### 3. If you need FSP<sup>®</sup> replacement parts\* ...

FSP is a registered trademark of Whirlpool Corporation for quality parts. Look for this symbol of quality whenever you need a replacement part for your Whirlpool appliance. FSP replacement parts will fit right and work right, because they are made to the same exacting specifications used to build every new Whirlpool appliance.

To locate FSP replacement parts in your area, contact the dealer from whom you purchased the unit or an authorized Whirlpool<sup>SM</sup> service company.

\* When requesting assistance, please provide: model number, serial number, date of purchase, and a complete description of the problem. This information is needed in order to respond to your request properly.



# WHIRLPOOL® Refrigerator Warranty

RF004

LENGTH OF WARRANTY	WHIRLPOOL WILL PAY FOR
<b>FULL ONE-YEAR WARRANTY</b> From Date of Purchase	FSP® replacement parts and repair labor to correct defects in materials or workmanship. Service must be provided by an authorized Whirlpool <sup>SM</sup> service company.
<b>FULL FIVE-YEAR WARRANTY</b> From Date of Purchase	FSP replacement parts and repair labor to correct defects in materials or workmanship in the sealed refrigeration system. These parts are: <ol style="list-style-type: none"> <li>1. Compressor</li> <li>2. Evaporator</li> <li>3. Condenser</li> <li>4. Drier</li> <li>5. Connecting tubing</li> </ol> Service must be provided by an authorized Whirlpool <sup>SM</sup> service company.
<b>WHIRLPOOL WILL NOT PAY FOR</b>	
<p><b>A.</b> Service calls to:</p> <ol style="list-style-type: none"> <li>1. Correct the installation of the refrigerator.</li> <li>2. Instruct you how to use the refrigerator.</li> <li>3. Replace house fuses or correct house wiring or plumbing.</li> <li>4. Replace light bulbs.</li> </ol> <p><b>B.</b> Repairs when refrigerator is used in other than normal, single-family household use.</p> <p><b>C.</b> Pickup and delivery. This product is designed to be repaired in the home.</p> <p><b>D.</b> Damage to refrigerator caused by accident, misuse, fire, flood, acts of God or use of products not approved by Whirlpool.</p> <p><b>E.</b> Any labor costs during the limited warranty.</p> <p><b>F.</b> Any food loss due to product failure.</p> <p><b>G.</b> Repairs to parts or systems caused by unauthorized modifications made to the appliance.</p>	

WHIRLPOOL CORPORATION SHALL NOT BE LIABLE FOR INCIDENTAL OR CONSEQUENTIAL DAMAGES.

Outside the United States, a different warranty may apply. For details, please contact your authorized Whirlpool distributor or military exchange.

® Registered Trademark / SM Service Mark of Whirlpool Corporation