

Return your Warranty Registration Card today to ensure you receive all the benefits you're entitled to.

Once your purchase is registered, you're eligible to receive all the privileges of owning this product. So complete and return the Warranty Registration Card enclosed with your purchase at once. And take advantage of these important benefits.

Warranty Verification

Registering your product within 10 days confirms your right to maximum protection under the terms and conditions of your warranty.

Owner Confirmation

Your completed Warranty Registration Card serves as verification of ownership in the event of product theft or loss.

Model Registration

Returning your Warranty Registration Card right away guarantees you'll receive all the information and special offers which you qualify for as the owner of your model.

MAGNAVOX

Smart. Very smart.®

Congratulations on your purchase, and welcome to the "family!"

Dear Magnavox product owner:

Thank you for your confidence in this product. You've selected one of the best-built, best-backed products available today. And we'll do everything in our power to keep you happy with your purchase for many years to come.

As a member of the Magnavox "family," you're entitled to protection by one of the most comprehensive warranties and outstanding service networks in the industry.

What's more, your purchase guarantees you'll receive all the information and special offers for which you qualify, plus easy access to accessories from our convenient home shopping network.

And most importantly, you can count on our uncompromising commitment to your total satisfaction.

All of this is our way of saying welcome - and thanks for investing in a Magnavox product.

P.S. Remember, to get the most from your product, you must return your Warranty Registration Card within 10 days. So please mail it to us right now!



Know these

safety symbols



⚡ This "bolt of lightning" indicates uninsulated material within your unit may cause an electrical shock. For the safety of everyone in your household, please do not remove product covering.

⚠ The "exclamation point" calls attention to features for which you should read the enclosed literature closely to prevent operating and maintenance problems.

WARNING: TO PREVENT FIRE OR SHOCK HAZARD, DO NOT EXPOSE THIS EQUIPMENT TO RAIN OR MOISTURE.

CAUTION: To prevent electric shock, match wide blade of plug to wide slot, fully insert.

ATTENTION: Pour éviter les choc électriques, introduire la lame la plus large de la fiche dans la borne correspondante de la prise et pousser jusqu'au fond.

For Customer Use

Below, enter your product's model number and serial number, which are located on the rear of the cabinet. Keep this information for future reference.

Model No. _____ Serial No. _____

Welcome to your VCR owner's manual.

This manual has seven sections: Setting Up Your VCR; Description of Controls; Basic Operations; Recording; Playing; Additional Features; and Information You May Need. The instructions explain all of the VCR's features, which are listed below. You cannot hurt your VCR by trying the features! So read on – and relax.

Features

- Automatic Channel Setup
- Automatic Head Cleaner
- Automatic Operation Features
- Automatic Tracking Adjustment
- Blue Background
- Daylight-Savings Time
- Display Panel
- Front Panel Menu Access
- Hi-Fi Stereo Sound System
- High Quality (HQ) System
- MTS (Multi-Channel Television Sound) System
- 19 micron head
- On-Screen Displays in English or Spanish
- One-Touch Recording
- Real-Time Counter
- Remote Control with glow-in-the-dark buttons and the capability to operate a TV, Cable Box, or Direct Broadcast System
- Repeat Play
- S-VHS Quasi Play Back (SQPB)
- Special Effects Playback: Forward and Reverse Searching; Still; Slow Motion
- Time Search
- Timer Recording

Safety Precautions

Warning: To prevent fire or shock hazard, do not expose this equipment to rain or moisture.

Federal Communications Commission Warning: Any unauthorized changes or modifications to this equipment void the user's authority to operate it.

This VCR has a High Quality (HQ) system and is compatible with existing Video Home System (VHS) equipment. Philips Consumer Electronics recommends you use only video cassette tapes that have the **VHS** mark. The use of other tapes may result in poor picture quality and excessive deposits on the video heads, which may not be covered by the warranty if damage occurs. The 19 micron head provides a better picture when you view tapes recorded in slow speed (SLP).

Note to the Cable TV System Installer: This reminder is provided to call the Cable TV system installer's attention to Article 820-40 of the National Electrical Code, which provides guidelines for proper grounding – in particular, specifying that the cable ground shall be connected to the grounding system of the building, as close to the point of cable entry as possible.

Declaration of Conformity

Model Number: VRC602MG
Trade Name: Magnavox
Responsible Party: Philips Consumer Electronics
P.O. Box 14810
Knoxville, TN 37914-1810
(865) 521-4316

As an ENERGY STAR® Partner, Philips Consumer Electronics has determined that this product meets the ENERGY STAR® guidelines for energy efficiency. ENERGY STAR® is a U.S. registered mark.

Using products with the ENERGY STAR® label can save energy. Saving energy reduces air pollution and lowers utility bills.

Copyright 2001 Philips Consumer Electronics. All rights reserved.



Helpful Hint

- *Your new product, its packaging, and this manual contain materials that can be recycled and reused. Specialized companies can recycle your product to increase the amount of reusable materials and to minimize the amount that needs to be properly disposed. Your product uses batteries that should not be thrown away when depleted but should be disposed of as small chemical waste. Please find out about the local regulations on disposal of your old product, batteries, manual, and packaging whenever you replace existing equipment.*

4 Table of Contents

Setting Up Your VCR

| | |
|---|-------|
| Introduction | 3 |
| Table of Contents | 4 |
| Before Using Your VCR | 5 |
| Hookups Without a Cable Box/Direct Broadcast System | 6-7 |
| Hookups With a Cable Box/Direct Broadcast System | 8-9 |
| Hookups With a Stereo TV | 10 |
| Turning on Your VCR | 11 |
| Automatic Channel Setup | 12-14 |
| Setting the Clock | 15 |
| Daylight-Savings Time | 16 |
| Language Selection | 17 |
| Setting the Remote to Operate a TV | 18 |
| Setting the Remote to Operate a Cable Box/Direct Broadcast System | 19 |

Description of Controls

| | |
|---------------------------|-------|
| Remote Control Buttons | 20-21 |
| On-Screen Status Displays | 22 |
| VCR Display Panel | 23 |
| Front Panel | 24 |
| Rear Panel | 25 |

Basic Operations

| | |
|-----------|----|
| Playing | 26 |
| Recording | 27 |

Recording

| | |
|--|-------|
| Recording One Channel/Watching Another | 28 |
| One-Touch Recording | 29 |
| Timer Recording | 30-33 |
| Rerecording (Tape Duplication) | 34 |

Playing

| | |
|------------------------------|----|
| Repeat Play | 35 |
| Real-Time Counter Memory | 36 |
| Time Search | 37 |
| Special Effects Playback | 38 |
| Automatic Operation Features | 39 |

Additional Features

| | |
|---------------------------------------|-------|
| Multi-Channel Television Sound System | 40-41 |
| Hi-Fi Stereo Sound System | 42 |
| Blue Background | 43 |

Information You May Need

| | |
|-------------------------|-------|
| Helpful Hints | 44-45 |
| Limited Warranty | 46-47 |
| Glossary/Specifications | 48 |
| Index | 49 |
| Accessories | 52 |

Before Using Your VCR 5

Putting Batteries in the Remote Control

1

Remove the battery compartment lid on the bottom of the remote control by pressing the tab, then lifting the lid.

2

Place two AA batteries inside the battery compartment with their + and - ends aligned as indicated.

3

Replace the battery compartment lid.

Battery Safety

- Battery Usage CAUTION - To prevent battery leakage that may result in bodily injury or damage to the unit: Install ALL batteries correctly, with the + and - markings on the battery aligned as indicated on the unit; Do not mix batteries, for example, old with new or carbon with alkaline; and Remove batteries when the unit will not be used for a long time.

Using the Remote Control

- Point the remote control at the VCR, then press the VCR button, before using the remote control to operate the VCR.
- Point the remote control at the TV, then press the TV button before using the remote control to operate the TV. *Details are on pages 18 and 20-21.*
- Point the remote control at the Cable Box or Direct Broadcast System (DBS), then press the CBL/DBS button before using the remote control to operate the Cable Box or DBS. *Details are on pages 19-21.*

Recording Prevention

Video cassette tapes have record tabs to ensure you do not accidentally erase recordings.

1

To prevent recording, break off the tab with a screwdriver.

2

To allow recording, cover the hole with cellophane tape.

VCR maintenance

- Use only tapes with the **VHS** mark.
- Remove any light adhesive stick-on notes from the video cassette tape before putting the tape in the VCR. Removable labels can jam the VCR.
- The VCR requires periodic maintenance to maintain its excellent performance. This VCR has an Automatic Head Cleaner. However, you may have to replace the video heads eventually. Only an authorized service center should perform this service.

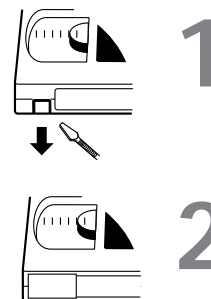
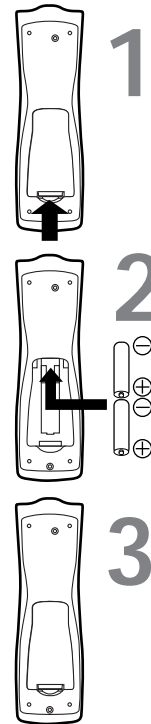

6 Hookups Without a Cable Box/Direct Broadcast System

The basic VCR/TV connection – antenna/cable to VCR to TV – is shown below. If you have a Cable Box or a Direct Broadcast System, please see pages eight-nine. If you have a Stereo TV, please see page 10. After you hook up the VCR, go to page 11 to turn on the VCR.

1

Disconnect the antenna or cable from your TV.

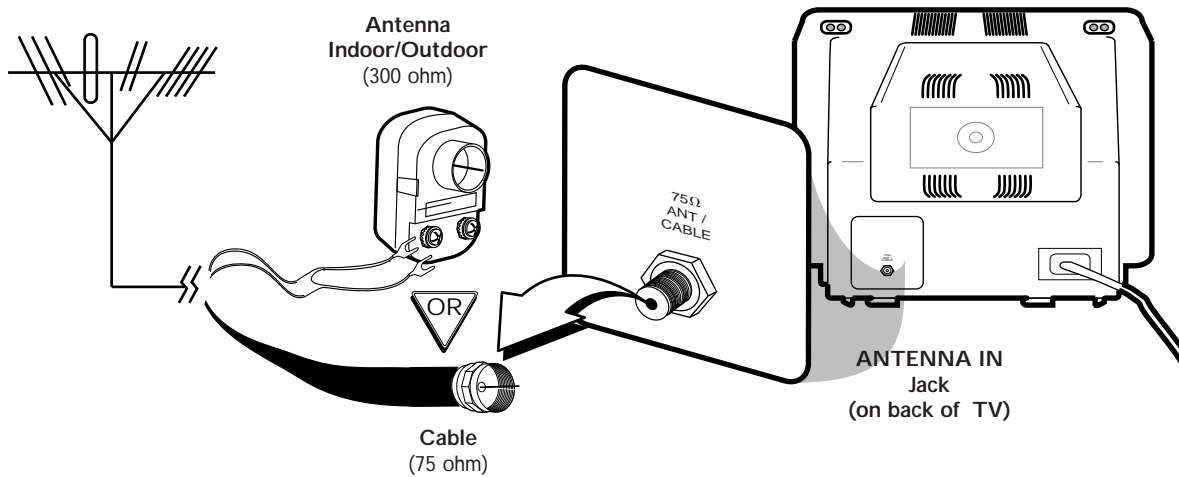

2

Connect the antenna or cable to the ANT(enna) IN Jack of your VCR.

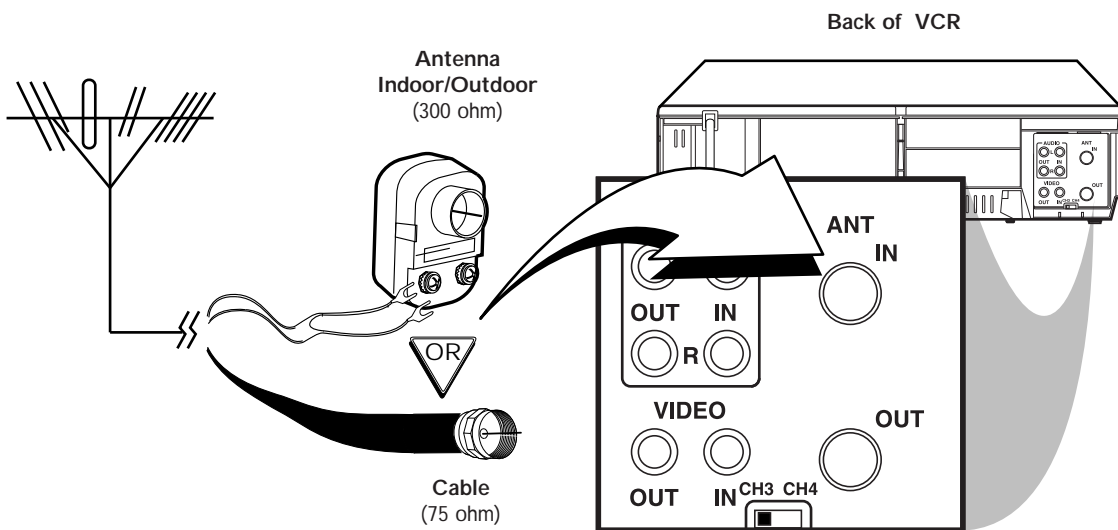

Hookups Without a Cable Box/Direct Broadcast System (cont'd) 7

3

Connect the supplied black RF coaxial cable to the **OUT** Jack on the back of the VCR and to the **ANTENNA IN** Jack on the TV. (You may use either a snap-on type (supplied) or screw-on type of coaxial cable, whichever you prefer.)

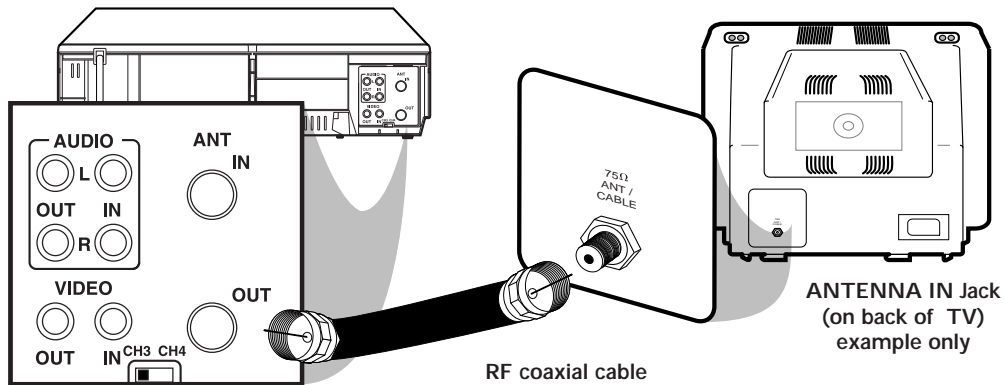

4

Plug in the power cords of the TV and the VCR.

5

Set the **CH3/CH4** switch on the back of the VCR to **CH3** or **CH4**, whichever channel is not used or least used in your area. **Set the TV to the same channel.** For example, when playing a tape, if the CH3/CH4 switch is set to CH3, the TV should be on channel 03.

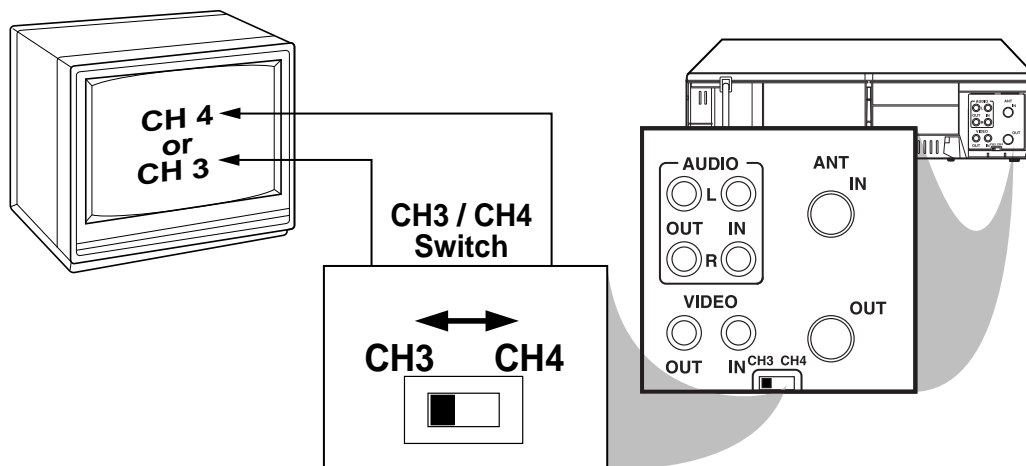

6

You are ready to turn on the VCR. Please go to page 11 before turning on the VCR.

8 Hookups With a Cable Box/Direct Broadcast System

There are two ways to connect your Cable Box/DBS to the VCR. With this connection:

- You may view any channel.
- You must select channels at the Cable Box/DBS. Channels cannot be changed at the VCR.
- You may not view a channel other than the one you are recording.
- You may not program channels at the VCR.
- You can only program a timer recording for one channel at a time. Set the TV and the VCR to the Cable Box/DBS output channel (channel 03 or 04); set the CH3/CH4 switch on the back of the VCR to the same channel. Set your Cable Box/DBS to the channel you want to record. When you enter the channel you want to record in a timer recording, select channel 03 or 04 (the Cable Box/DBS output channel). (This is step 5 on page 31.) Leave the Cable Box/DBS on for a timer recording.

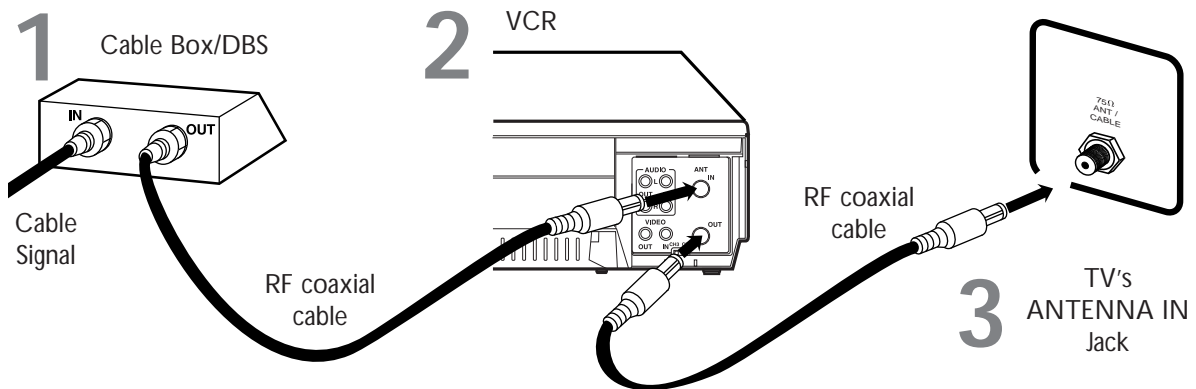

Connections

1

Connect a Cable signal to the IN Jack on the Cable Box/DBS.

2

Use the supplied black RF coaxial cable to connect the OUT Jack on the Cable Box/DBS to the ANT(enna) IN Jack on the VCR.

3

Use a second RF coaxial cable (not supplied) to connect the OUT Jack on the VCR to the TV's ANTENNA IN Jack.

Recording/Viewing Any Channel

1

With the VCR on and in VCR position (the VCR light will appear on the display panel), use the CH(annel) ▲/▼ buttons to set the VCR to the Cable Box/DBS output channel (channel 03 or 04). Set the CH3/CH4 switch on the back of the VCR to the same channel.

2

Set the TV to the same channel to which you set the VCR.

3

Select the channel you want to view/record at the Cable Box/DBS.

Hookups With a Cable Box/Direct Broadcast System (cont'd) 9

With this connection:

- You may watch one channel while recording another.
- You may not record scrambled channels.

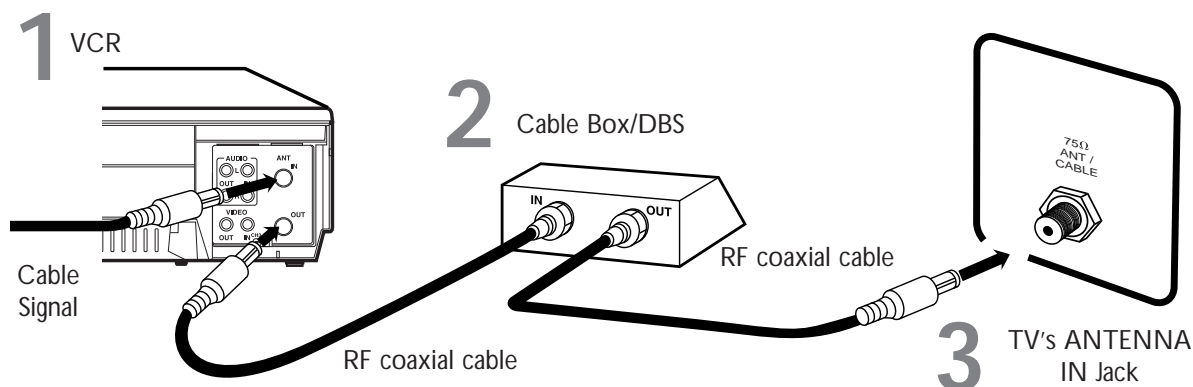

Connections

1

Connect a Cable signal to the VCR's ANT(enna) IN Jack.

2

Use the supplied black RF coaxial cable to connect the OUT Jack on the VCR to the IN Jack on the Cable Box/DBS.

3

Use a second RF coaxial cable (not supplied) to connect the OUT Jack on the Cable Box/DBS to the ANTENNA IN Jack on the TV.

Recording One Channel/Watching Another

1

Put the Cable Box/DBS on the same channel as the VCR's CH3/CH4 switch. Set the TV to the Cable Box/DBS output channel (03 or 04).

Then, with the VCR in VCR position (the VCR light will appear on the display panel), use the CH(annel) ▲/▼ buttons to select the channel you want to record at the VCR. Start the recording.

2

Press the VCR/TV button once to put the VCR in TV position. (The VCR light will disappear.)

3

Select the channel you want to watch at the Cable Box/DBS.

Helpful Hint

- When you play a tape, make sure the Cable Box/DBS is set to the same channel as the CH3/CH4 switch on the VCR. Set the TV to the Cable Box/DBS output channel (03 or 04).

10 Hookups with a Stereo TV

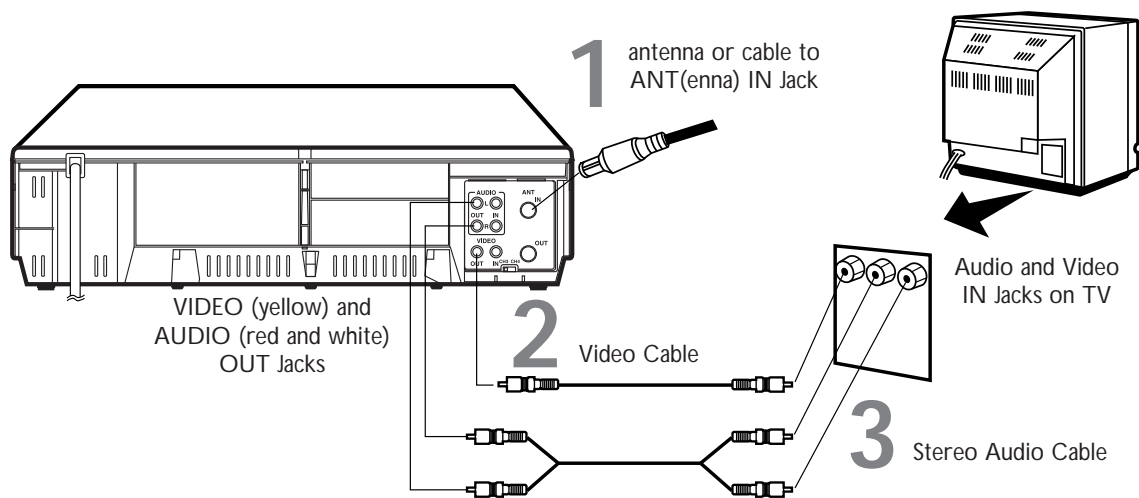

- Audio and Video cables are not supplied.

1

Connect the antenna or cable to the ANT(enna) IN Jack on the back of the VCR.

2

Connect a video cable to the yellow VIDEO OUT Jack on the back of the VCR. Then, connect the other end of the video cable to the VIDEO IN Jack on your TV.

3

Connect a stereo audio cable to the red and white AUDIO OUT Jacks on the back of the VCR, matching cable colors to the jack colors. Then, connect the other end of the audio cable to the AUDIO IN Jacks on your TV, again matching cable colors to the jack colors.

If your TV's AUDIO IN jacks are not color coded, connect the red (right) AUDIO OUT jack of the VCR to the right channel AUDIO IN jack on the TV. Connect the white (left) AUDIO OUT jack of the VCR to the left channel AUDIO IN jack on the TV.

4

Turn on your TV, making sure it is in Line Input mode. This might be referred to as the TV's Audio/Video In channel or the Auxiliary In channel. Please refer to your TV owner's manual for details.

Turning on Your VCR 11

Before turning on your VCR, make sure batteries are in the remote control and you have connected the VCR and TV correctly. *Details are on pages five-10.*

- You can not program channels if you are using a Cable Box or a Direct Broadcast System.
- When the VCR clock is not set, - : - - will appear on the display panel.

1

Press the VCR button, then press the POWER button. The VCR light and the PWR.(power) light will appear on the VCR display panel.

2

Turn on the TV. Set it to the same channel as the CH3/CH4 switch on the back of the VCR. The display shown below will appear on the TV screen. (If the display does not appear, check your hookups, then follow the steps on page 12 to set up channels and page 17 to select a language.)

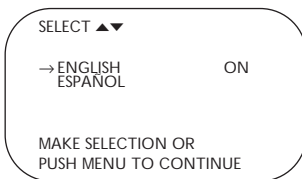

3

Within 60 seconds, press the PLAY/▲ button or the STOP/▼ button to select English or Spanish on-screen displays and menus.

4

Press the MENU button. The display shown below will appear.

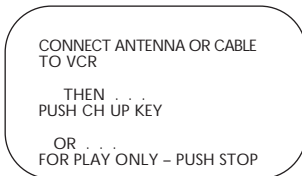

5

Within 60 seconds, press the CH(annel) ▲ button to begin automatic channel programming. AUTO CH PROGRAMMING IN PROCESS PLEASE WAIT will appear on the TV screen. Channel numbers will appear on the VCR display panel as they are scanned. The VCR will memorize all available channels. When all channels are memorized, CHANNELS ARE SET will appear on the TV screen briefly, then TV programming will appear.

Now, when you press the CH(annel) ▲/▼ buttons, you'll only scan through channels that you receive. You can still select other channel numbers using the Number buttons.

2

Turn on the TV.

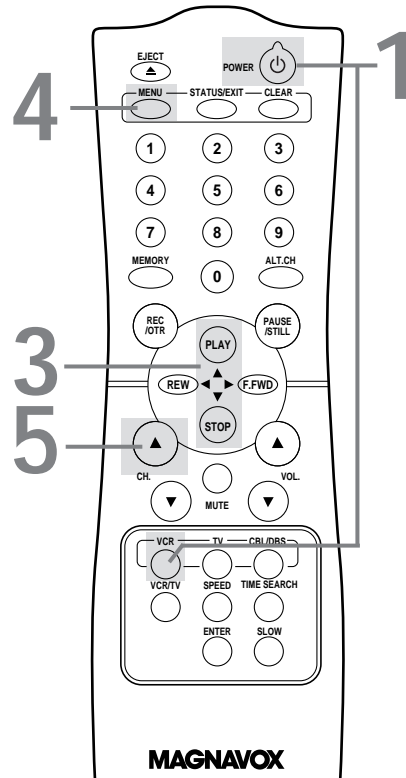

Helpful Hints

- To skip this feature and play a tape immediately, insert a tape with its record tab removed. Or, to skip step 3, press the MENU button. All on-screen displays will be in English. To skip step 5, press the STOP/▼ button. Channels will not be programmed, and CHANNELS NOT SET will appear on the screen.
- If you try to program channels when there is no antenna or cable connected to the VCR, programming will appear to take place, but eventually a NO TV SIGNALS message will appear. Connect an antenna or cable to the VCR's ANT(enna) IN Jack and press the CH(annel) ▲ button again. You may need to follow the steps on page 12.
- You may need to repeat the steps on this page if a power failure occurs.

12 Automatic Channel Setup

Although your VCR may automatically memorize the channels you receive when you turn it on for the first time, this function lets you set up the channels again.

1

Press the **VCR** button, then press the **MENU** button.

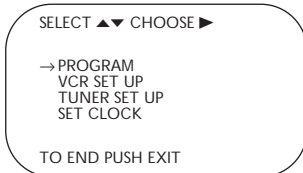

2

Press the **PLAY/▲** button or the **STOP/▼** button to select **TUNER SET UP**, then press the **F.FWD/▶** button.

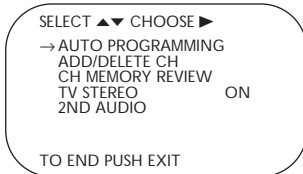

3

Press the **PLAY/▲** button or the **STOP/▼** button to select **AUTO PROGRAMMING**, then press the **F.FWD/▶** button. The VCR distinguishes between TV channels and cable channels, and the VCR will memorize all the channels you receive.

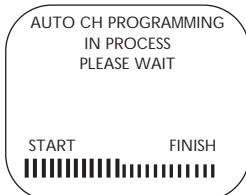

4

Wait for a few minutes while the VCR sets up the channels. The channel numbers will appear on the VCR display panel as they are scanned. When this is complete, **CHANNELS ARE SET** will appear on the screen. Then the programming of the lowest channel number placed in the VCR's memory will appear on the screen. Now when you press the **CH(annel) ▲/▼** buttons, you will scan only through channels you receive. You may still select non-memorized channels by pressing the Number buttons.

2-3

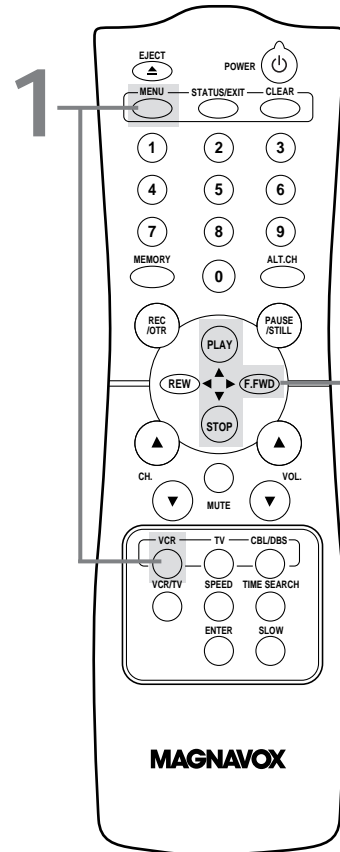

Helpful Hints

- You can not enter the **TUNER SET UP** menu when you are in **Line Input mode** (channel 001 or 002). When you select channel 001 or 002, **AV REAR** or **AV FRONT** will appear on the TV screen briefly.
- You can not program channels if you are using a **Cable Box** or **DBS**.
- If you have an antenna, channels 2-69 will be available. If you have a cable connection, channels 1-125 will be available.
- You may need to repeat the steps on this page if a power failure occurs.

Automatic Channel Setup (cont'd) 13

Adding/Deleting Channels

If your channel lineup changes, you may want to add newly available channels or remove channels that are no longer available in your area. You can use the CH(annel) ▲/▼ buttons to scroll through only the available channels. To add or delete channels from the VCR's memory, follow these steps.

1

Press the VCR button, then press the MENU button.

2

Press the PLAY/▲ button or the STOP/▼ button to select TUNER SET UP, then press the F.FWD/▶ button.

3

Press the PLAY/▲ button or the STOP/▼ button to select ADD/DELETE CH, then press the F.FWD/▶ button.

| SELECT ▲▼ | ADD/DELETE ▶ |
|-----------|--------------|
| 124 | DELETED |
| 125 | DELETED |
| 1 | → DELETED |
| 2 | ADDED |
| 3 | ADDED |

TO END PUSH EXIT

NOTE: If you have an antenna, channel numbers 2-69 will appear on the ADD/DELETE CH menu. If you have a cable connection, channels 1-125 will be available.

4

Press the PLAY/▲ button or the STOP/▼ button until the channel number you want to add or delete appears beside the arrow.

| SELECT ▲▼ | ADD/DELETE ▶ |
|-----------|--------------|
| 16 | DELETED |
| 17 | ADDED |
| 18 | → ADDED |
| 19 | ADDED |
| 20 | ADDED |

TO END PUSH EXIT

5

Press the F.FWD/▶ button to select ADDED or DELETED. Repeat steps 4 and 5 until you have added or deleted all the channels you wanted to add or delete.

6

Press the STATUS/EXIT button.

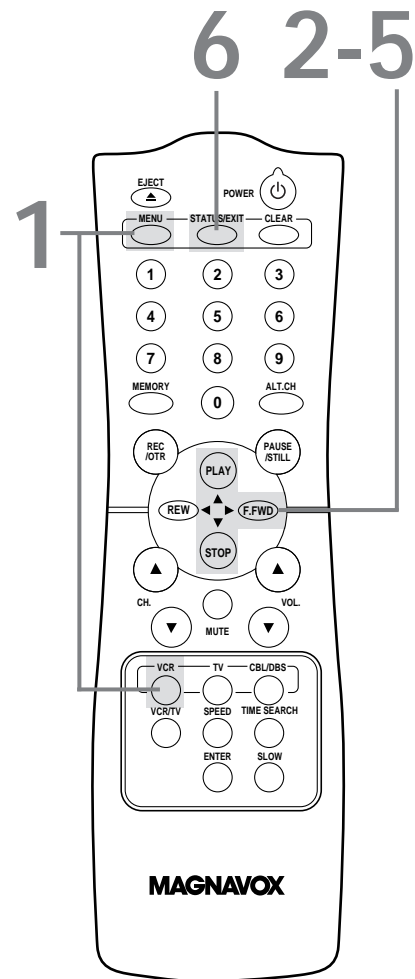

14 Automatic Channel Setup (cont'd)

Reviewing Memorized Channels

1

Press the **VCR** button, then press the **MENU** button.

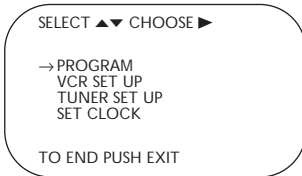

2

Press the **PLAY/▲** button or the **STOP/▼** button to select **TUNER SET UP**, then press the **F.FWD/►** button.

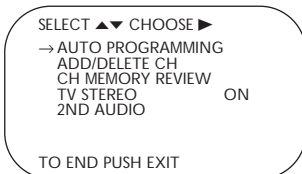

3

Press the **PLAY/▲** button or the **STOP/▼** button to select **CH MEMORY REVIEW**, then press the **F.FWD/►** button. A list of programmed channels will appear on the screen.

- If all the programmed channels don't fit on the screen, press the **F.FWD/►** button to see the remaining channels. Then press the **REW(ind)/◀** button to return to the first screen of channels. If there are no more channels, pressing the **F.FWD/►** button will take you back to the previous menu.
- If you do not press any buttons within 10 seconds, you will either go to the next screen of channels or you will return to the previous menu.

4

Press the **STATUS/EXIT** button once or twice to exit.

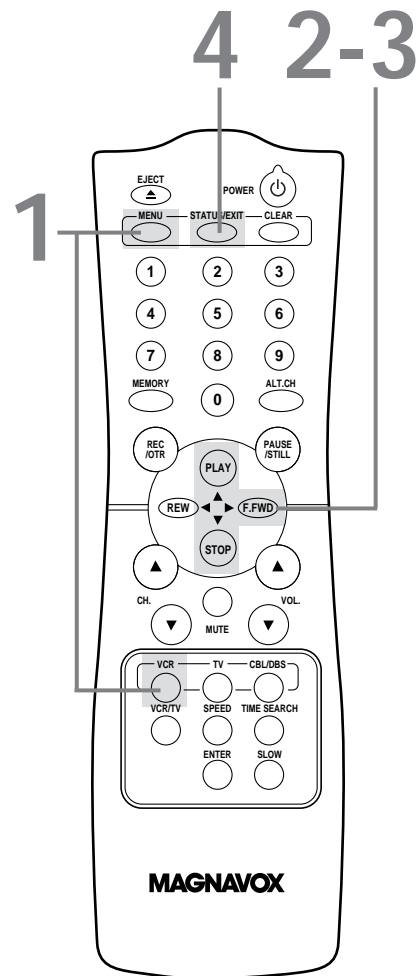

Setting the Clock 15

Follow the steps below to set your VCR's clock. Make sure:

- The VCR is on and the VCR light appears on the display panel.
(If it does not, press the VCR/TV button once.)
- You make each entry within 60 seconds of the previous entry.

1

Press the VCR button, then press the MENU button.

2

Press the PLAY/▲ button or the STOP/▼ button to select SET CLOCK, then press the F.FWD/▶ button.

3

Press the PLAY/▲ button or the STOP/▼ button to select SET CLOCK again, then press the F.FWD/▶ button.

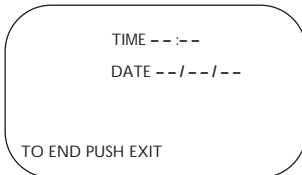

4

Press two Number buttons for the hour(s) and two Number buttons for the minute(s). Then press 1 for AM or 2 for PM. For example, for 2:15 PM, press 02, 15, 2.

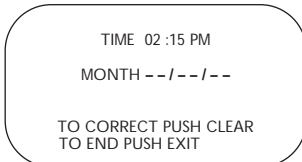

5

Press two Number buttons for the month, two Number buttons for the day, and two Number buttons for the year. For example, for July 1, 2001, press 07, 01, 01. The day of the week will appear automatically.

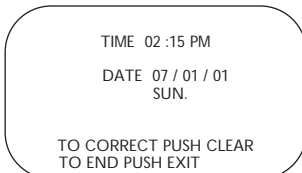

6

Press the STATUS/EXIT button.

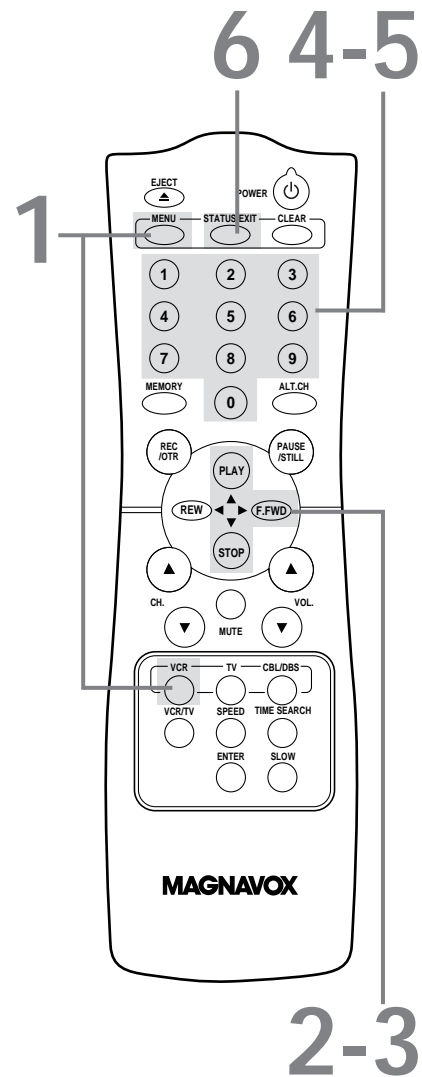

Helpful Hints

- Enter a 0 before a single-digit number.
- Entries that do not match the VCR's clock or calendar will cause a question mark to appear on the screen.
- To make corrections, press the CLEAR button until the space for the number you want to correct is flashing. Then enter the correct number.
- To see the current time on the TV screen, press the STATUS/EXIT button. Details are on page 22.
- When the VCR clock is not set, -:-- will appear on the display panel.
- The VCR may lose the clock setting if the power fails.

16 Daylight-Savings Time

You may program the VCR so its clock will automatically move forward one hour in April and turn back one hour in October. Daylight-Savings Time is ON when you receive your VCR. Turn Daylight-Savings Time ON or OFF by following the steps below. Before you begin:

- Make sure you have set the clock. *Details are on page 15.*

1

Press the VCR button, then press the MENU button.

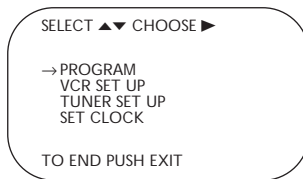

2

Press the PLAY/▲ button or the STOP/▼ button to select SET CLOCK, then press the F.FWD/► button.

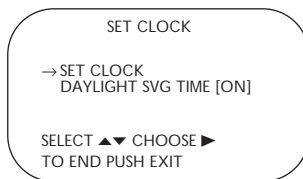

3

Press the PLAY/▲ button or the STOP/▼ button to select DAYLIGHT SVG TIME. Then, press the F.FWD/► button so that OFF (or ON) appears beside DAYLIGHT SVG TIME.

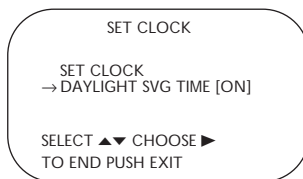

4

Press the STATUS/EXIT button.

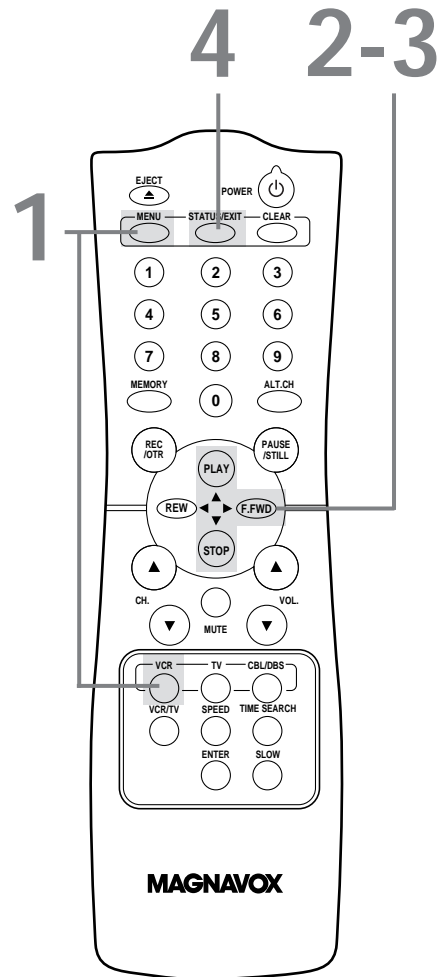

Language Selection 17

Follow the steps below to change the language of the on-screen displays and menus.

1

Press the VCR button, then press the MENU button.

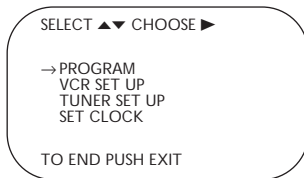

2

Press the PLAY/▲ button or the STOP/▼ button to select VCR SET UP, then press the F.FWD/► button.

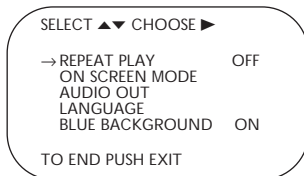

3

Press the PLAY/▲ button or the STOP/▼ button to select LANGUAGE, then press the F.FWD/► button.

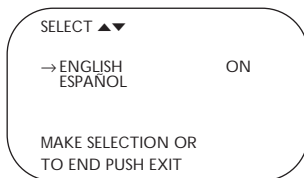

4

Press the PLAY/▲ button or the STOP/▼ button to select English or Spanish on-screen displays and menus.

5

Press the STATUS/EXIT button.

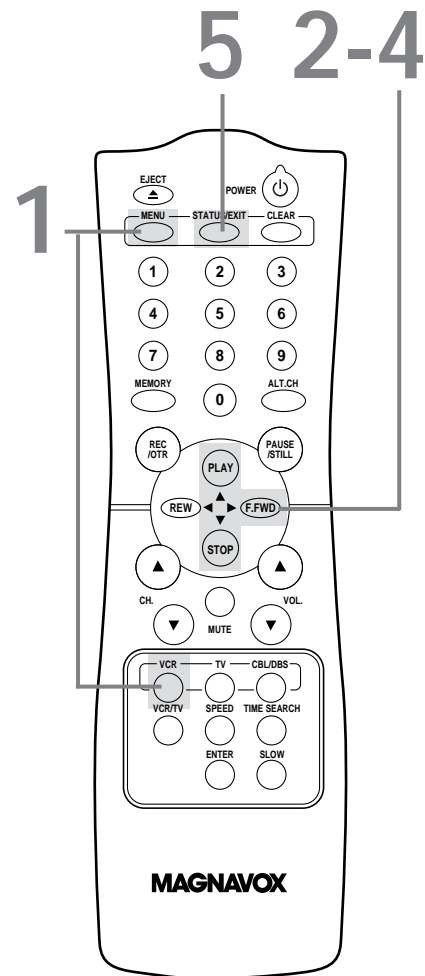

Helpful Hint

- If you accidentally select Spanish and need English:
 1. Press the VCR button, then press the MENU button.
 2. Press the PLAY/▲ button or the STOP/▼ button to select PREPARE EL VCR, then press the F.FWD/► button.
 3. Press the PLAY/▲ button or the STOP/▼ button to select LENGUAJE, then press the F.FWD/► button.
 4. Press the PLAY/▲ button or the STOP/▼ button to select ENGLISH.
 5. Press the STATUS/EXIT button.

18 Setting the Remote to Operate a TV

Your VCR remote control **may** operate your TV. If the remote control doesn't operate your TV now, follow the steps below.

1

Point the remote control at your TV and press the **TV** button. Then, press the **POWER** button. If your TV turns on or off, try the other TV buttons (see pages 20-21). If your TV doesn't turn on or off, or if the other buttons don't work, go to step 2.

2

Find the brand of your TV on the list below, and remember the two-digit number beside it.

| TV CODES | | | | | |
|-----------------|---------------------|-----|------------------|-----------------|---------|
| EMERSON | | .14 | PHILCO | | .14 |
| FISHER | | .11 | PHILIPS | | .01 |
| GE | | .10 | PHILIPS MAGNAVOX | . .01, 02, 03 | |
| GOLDSTAR | | .04 | QUASAR | | .07 |
| HITACHI | | .12 | RCA | | .10 |
| JVC | | .05 | SAMSUNG | | .17 |
| MAGNAVOX |01, 02, 03 | | SANYO | | .11 |
| MARANTZ | | .13 | SEARS |08, 11 | |
| MITSUBISHI | | .13 | SHARP | | .16 |
| MONTGOMERY WARD | | .14 | SONY | | .09 |
| PANASONIC | | .07 | TOSHIBA | | .08 |
| PANASONIC-GA00 | | .07 | ZENITH | | .06, 15 |

3

Press the **MUTE** button.

4

Within 30 seconds, press the **TV** button.

5

Within 30 seconds, press the **Number** buttons to enter the two-digit code for your TV brand. For example, if you have a Zenith TV, press Number buttons 0, 6.

6

Repeat step 1. If the remote control works your TV, you're finished. If the remote control still doesn't work your TV, repeat steps 3-5, using a different code for your brand (if available).

There is no guarantee that the remote will work your TV.

2

Find your TV code.

1&6

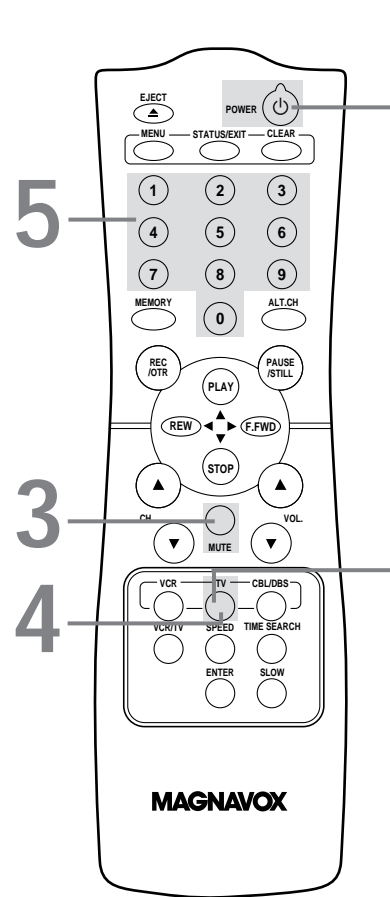

Helpful Hints

- The remote control may only operate some features of your TV. For example, the remote control may turn on the TV power, but it may not change channels at the TV.
- If you can not change the channels at the TV using the Number buttons, press the ENTER button after you press the Number buttons. It may change channels at the TV.
- When you replace the batteries in the remote control, you may need to program the remote control again.
- Remember to point the remote control toward the TV during steps 1-6.

Setting the Remote to Operate a Cable Box/Direct Broadcast System 19

Your VCR remote control **may** operate your Cable Box or Direct Broadcast System (DBS). If the remote control doesn't operate your Cable Box or DBS now, follow the steps below.

1

Turn on the Cable Box/DBS. Then, point the remote control at your Cable Box/DBS and press the CBL/DBS button. Then, press the POWER button. If your Cable Box/DBS turns off, try the other Cable Box/DBS buttons (see pages 20-21). If your Cable Box/DBS doesn't turn off, or if the other buttons don't work, go to step 2.

2

Find the brand of your Cable Box or DBS on the lists below and remember the two-digit number beside it.

| CABLE BOX CODES | | |
|---|-------------------------------|---|
| ARCHER.....01, 05, 06, 44 | MAGNAVOX.....26 | SAMSUNG.....05, 06, 40, 42 |
| CABLETENNA.....01, 44 | MATSUSHITA.....16, 17, 97 | SCIENTIFIC ATLANTA.....08, 09 |
| CABLEVIEW.....04, 30, 42, 44, 52 | NOVAVISION.....08, 09 | SIGNAL.....26 |
| CENTURY.....44 | NSC/NEC.....40 | SL MARX.....06, 40, 42, 44, 52 |
| CITIZEN.....04, 30, 42, 44, 52 | OAK.....11, 46 | SPRUCER.....16, 17, 97 |
| CURTIS.....08, 09 | OAK SIGMA.....11, 46 | STANDARD COMPONENTS.....42, 44 |
| DIAMOND.....01, 44 | PANASONIC.....16, 17, 97 | STARTRON.....04, 06, 30, 40, 42, 44, 52 |
| EAGLE.....26, 40, 62 | PHILIPS.....07, 23, 50 | TELEVIEW.....06, 40, 42 |
| EASTERN/REGENCY.....28 | PIONEER.....05, 06 | TOCOM.....01, 33, 34, 42 |
| GC BRAND.....04, 30, 42, 44, 52 | PULSAR.....04, 30, 42, 44, 52 | UNIKA.....01, 44 |
| GEMINI/JASCO.....04 | QUEST.....05, 06 | UNIVERSAL.....42, 44, 52 |
| GENERAL ELECTRIC.....01, 57 | RCA.....16, 17, 97 | VIDEOWAY.....07, 23, 50 |
| GENERAL INSTRUMENT.....01, 02, 03, 04, 34, 83 | REALISTIC.....44 | VIEWSTAR.....26, 40, 62 |
| HAMLIN.....14, 15, 28, 41 | RECOTON.....44 | ZENITH.....07, 23, 50 |
| JERROLD.....01, 02, 03, 04, 34, 83 | REGAL.....14, 15, 28, 41 | |
| | REMBRANDT.....01, 42, 44 | |

| DIRECT BROADCAST SYSTEM CODES | | |
|-------------------------------|------------|-------------|
| MAGNAVOX.....94,95 | RCA.....97 | SONY.....98 |

3

Press the MUTE button.

4

Within 30 seconds, press the CBL/DBS button.

5

Within 30 seconds, press the Number buttons to enter the two-digit code for your Cable Box or DBS. For example, if you have a Zenith Cable Box, press Number buttons 0,7.

6

Repeat step 1. If the remote control works your Cable Box or DBS, you're finished. If the remote control still doesn't work your Cable Box or DBS, repeat steps 3-5, using a different code for your brand, if available.

2

Find your code.

1&6

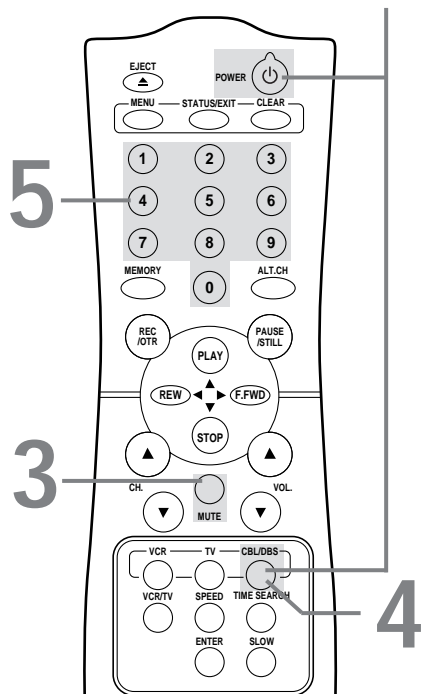

There is no guarantee that the remote will work your Cable Box or DBS.

Helpful Hints

- The remote control may only operate some features of your Cable Box/DBS. For example, the remote control may turn off the Cable Box/DBS power, but it may not change channels at the Cable Box/DBS.
- If you can not change the channels at the Cable Box using the Number buttons, press the ENTER button after you press the Number buttons. It may change channels at the Cable Box.
- When you replace the batteries in the remote control, you may have to program the remote control again.
- Remember to point the remote control toward the Cable Box/DBS during steps 1-6.
- Some Cable Boxes can only be turned on at the Cable Box.

20 Remote Control Buttons

POWER Button
Press to turn on or off the VCR, TV, Cable Box, or Direct Broadcast System. (You must first press the VCR, TV, or CBL/DBS button.)

EJECT Button
Press to eject the tape.

MENU Button
Press to access the VCR menu or some TV menus.

Number Buttons
Press to select channels at the VCR, TV, Cable Box, or Direct Broadcast System; use to set up VCR features (such as the clock).
Cable Users ●
Enter channel numbers as a two-digit number for the quickest results. For example, to select channel 6, press 0,6. If you only press the Number 6 button, channel 6 will appear after a brief delay. (There also may be a brief delay when you select channels 10, 11, and 12.) To select channels 100 and above, enter channel numbers as a three-digit number. For example, to select channel 117, press 1, 1, 7.
Antenna Users ●
Enter channel numbers as a two-digit number for the quickest results. You may only select channels 2-69. For example, to select channel 5, press 0,5. If you only press the Number 5 button, channel 5 will appear after a brief delay.

MEMORY Button
Press to memorize a tape position at which the real-time counter was set to 0:00:00. *Details are on page 36.*

REC(ord)/OTR Button
Press once to start a recording. *Details are on page 27.* Or, press repeatedly to start a One-Touch Recording. *Details are on page 29.*

PLAY/▲ Button
Press to play a tape; press to release Slow, Search, or Still mode and return to normal playback. *Details are on page 38.* Press to select an item in the VCR's on-screen menu or some TV menus.

MUTE Button
Press to eliminate the TV's sound. Press again to restore the volume. If you mute the volume, pressing the VOL(ume) ▲ button also will restore the volume.

VCR Button
Press to operate the VCR with the remote control.

SPEED Button
Press to select the recording speed (SP or SLP). *Details are on pages 32 and 48.*

SLOW Button
During tape playback, press to view the picture in slow motion. Press again to resume normal playback. *Details are on page 38.*

VOL(ume) ▲/▼ Buttons
Press to adjust the TV's volume.

PAUSE/STILL Button
While recording, press to temporarily stop the recording (pause). Press a second time to resume normal recording. *Details are on page 27.* You can not pause a One-Touch Recording. Or, press during tape playback to freeze the picture. Press again to resume playback. *Details are on page 38.*

Helpful Hints

- Press the VCR button before pressing VCR feature buttons; press the TV button before pressing TV feature buttons; press the CBL/DBS button before pressing Cable Box/Direct Broadcast System feature buttons.
- Buttons that are shaded in the illustration will glow for some time after exposure to direct light.
- Buttons with a shaded description may also operate features of your TV, Cable Box, or Direct Broadcast System.

Remote Control Buttons (cont'd) 21

| | |
|---|--|
| <p>CLEAR Button Press to erase incorrect information when programming VCR functions. Also, press to reset the real-time counter. <i>Details are on page 36.</i></p> | |
| <p>STATUS/EXIT Button Press to access or remove the VCR's on-screen status display. <i>Details are on page 22.</i> Press to exit on-screen VCR menus. Or, press to access or remove a status display or menu of some TVs.</p> | |
| <p>REW(ind)/◀ Button When tape playback is stopped, press to rewind the tape at high speed. During playback, press to rewind the tape while the picture stays on the screen. <i>Details are on page 38.</i> Press to return to a previous VCR menu. Press to adjust the controls of some TV menus.</p> | |
| <p>STOP/▼ Button Press to stop the tape. Press to select an item in the VCR menu or some TV menus.</p> | |
| <p>CH(annel) ▲/▼ Buttons Press to change channels at the VCR, TV, Cable Box, or Direct Broadcast System.</p> | |
| <p>VCR/TV Button Press to select VCR position or TV position.</p> | |
| <p>VCR Position ● Use to watch a tape, to watch a program while recording it, or to watch a TV broadcast using the CH(annel) ▲/▼ or Number buttons to change channels at the VCR. If the VCR light appears on the display panel of the VCR, it is in VCR position.</p> | |
| <p>TV Position ● Use to watch TV (changing channels at the TV) or to watch one program while recording another. <i>Details are on page 28.</i> If the VCR light doesn't appear on the display panel of the VCR, it is in TV position.</p> | |
| <p>ENTER Button Press after pressing the Number buttons to select a channel at the TV or the Cable Box. <i>Details are on pages 18-19.</i></p> | |
| <p>TV Button Press to operate the TV. <i>Details are on page 18.</i></p> | |
| <p>TIME SEARCH Button Press to fast forward or rewind the tape a specific length of time. <i>Details are on page 37.</i></p> | |
| <p>CBL/DBS Button Press to operate the Cable Box or Direct Broadcast System. <i>Details are on page 19.</i></p> | |
| <p>F.FWD(Fast Forward)▶ Button When playback is stopped, press to fast forward the tape at high speed. During playback, press to fast forward the tape while the picture stays on the screen. <i>Details are on page 38.</i> Press to advance to the next VCR menu, to change the setting of an item in the VCR menu, or to adjust the controls in some TV menus.</p> | |
| <p>ALT. CH (Alternate Channel) Button Press while in TV position to return to the TV channel you were viewing immediately before switching to your current channel. (If you press the ALT.CH button while in VCR position, the TV will change to the channel you last selected before choosing channel 3 or 4 to use the VCR. However, the TV channel will not be clear, because you are in VCR position.)</p> | |

Helpful Hints

- Press the VCR button before pressing VCR feature buttons; press the TV button before pressing TV feature buttons; press the CBL/DBS button before pressing Cable Box/Direct Broadcast System feature buttons.
- Buttons that are shaded in the illustration will glow for some time after exposure to direct light.
- Buttons with a shaded description may also operate features of your TV, Cable Box, or Direct Broadcast System.

22 On-Screen Status Displays

A status display will appear when you press the STATUS/EXIT button or certain function buttons. The contents of the status display will vary. To choose the status display mode, follow the steps below.

If you select STATUS ON, then select COUNTER ONLY ON:

- Whenever you press the STOP/▼ button or the PLAY/▲ button, the status display will appear for five seconds. After five seconds, only the counter will remain on the screen. You must press the STATUS/EXIT button to remove it. Portions of the status display also may appear when you press other function buttons.

If you select STATUS ON, then select COUNTER ONLY OFF:

- Whenever you press the STOP/▼ button or the PLAY/▲ button, the status display will appear for five seconds. Portions of the status display also may appear when you press other function buttons.

If you select STATUS OFF:

- The status display will not appear when you press function buttons. You must press the STATUS/EXIT button to see the status display.

1

Press the VCR button, then press the MENU button.

2

Press the PLAY/▲ button or the STOP/▼ button to select VCR SET UP, then press the F.FWD/▶ button.

3

Press the PLAY/▲ button or the STOP/▼ button to select ON SCREEN MODE, then press the F.FWD/▶ button.

4

Press the PLAY/▲ button or the STOP/▼ button to select STATUS, then press the F.FWD/▶ button so that OFF (or ON) appears beside STATUS.

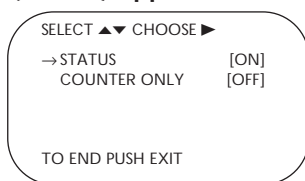

5

If you set STATUS to OFF, go to step 6. If you set STATUS to ON, press the PLAY/▲ button or the STOP/▼ button to select COUNTER ONLY, then press the F.FWD/▶ button so that OFF (or ON) appears beside it.

6

Press the STATUS/EXIT button.

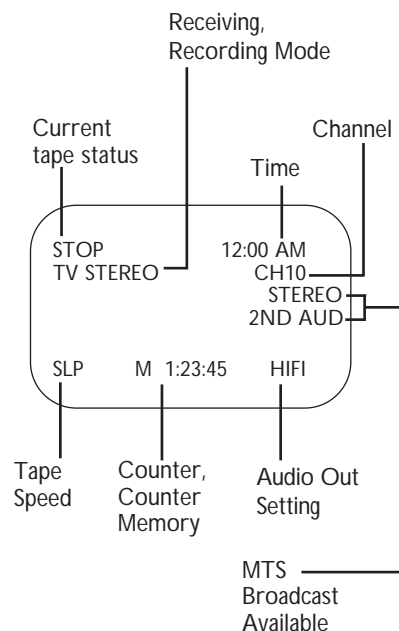

Helpful Hints

- You may not access a status display when viewing a still picture, during slow motion playback, or during forward or reverse searching.
- The status display may not appear if a weak channel is selected and BLUE BACKGROUND is set to OFF. Details are on page 43.

VCR Display Panel 23

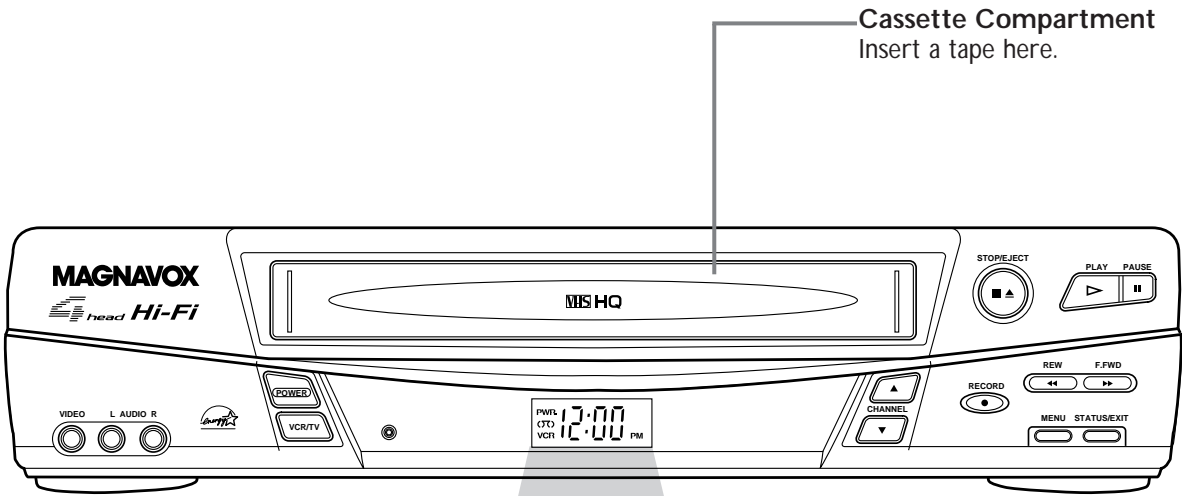

Cassette Compartment
Insert a tape here.

PWR.(power) Light
This light appears when the power is on.

Cassette-Inside Light
This light appears when a tape is in the VCR.

VCR Light
This light appears when the VCR is in VCR position. This light does not appear when the VCR is in TV position.
Details are on pages 21 and 24.

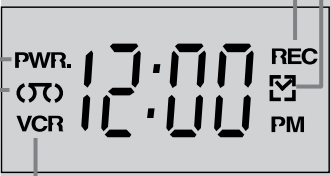

REC(ord) Light
This light appears during a recording. It flashes when a recording is paused.

Timer Light
This light glows when the VCR is turned off to set a timer recording, during a timer recording, or during a One-Touch Recording. It flashes if the power is off for a timer recording, but there is no tape in the VCR. It flashes when all timer recordings or One-Touch Recordings are finished.

Clock Display
The current time appears here when the clock is set. If the clock is not set, -:- will appear here. PM will appear on the display, but AM will not.

24 Front Panel

Remote Sensor

Receives a signal from your remote control so you can operate your VCR from a distance.

POWER Button

Press to turn the VCR power on and off.

VIDEO In Jack

Connect a video cable coming from the video out jack of a camcorder, another VCR, or an audio-visual source (laser disc player, digital video disc player, etc.) here. *Details are on page 34.*

AUDIO In Jacks

Connect the audio cables coming from the audio out jacks of a camcorder, another VCR, or an audio source here. *Details are on page 34.*

VCR/TV Button

Press to select VCR or TV position.

● VCR Position

Use to watch a tape, to watch a program while recording it, or to watch a TV program (changing channels at the VCR). When the VCR light appears on the display panel, the VCR is in VCR position.

● TV Position

Use to watch TV (changing channels at the TV) or to watch one program while recording another. When the VCR light does not appear on the display panel, the VCR is in TV position.

STOP/EJECT Button

Press once to stop the tape. When playback is stopped, press to eject the tape. Press to select an item in the menu.

PAUSE Button

While recording, press to pause the recording. Press again to resume recording. *Details are on page 27.* You can not pause a One-Touch Recording. During tape playback, press to freeze the picture. Press again to resume playback. *Details are on page 38.*

PLAY Button

Press to play a tape. Press to release Slow, Search, or Still mode and return to playback. *Details are on page 38.* Press to select an item in the menu.

REW(ind) Button

When playback is stopped, press to rewind the tape at high speed. During playback, press to rewind the tape while the picture stays on the screen. *Details are on page 38.* Press to return to a previous menu.

CHANNEL (▼/▲) Buttons

Press to change channels at the VCR. Or, press to adjust the tracking of a tape during normal playback or slow motion playback. Also, press to remove vertical jitter in a Still picture.

RECORD Button

Press once to start a recording. Press repeatedly to start a One-Touch Recording. *Details are on page 29.*

MENU Button

Press to access the VCR menu.

STATUS/EXIT Button

Press to access or remove the on-screen status display. *Details are on page 22.* Press to exit on-screen menus.

F.FWD (Fast Forward) Button

When playback is stopped, press to fast forward the tape at high speed. During tape playback, press to fast forward the tape while the picture stays on the screen. *Details are on page 38.* Press to advance to the next menu or to change the setting of an item in the menu.

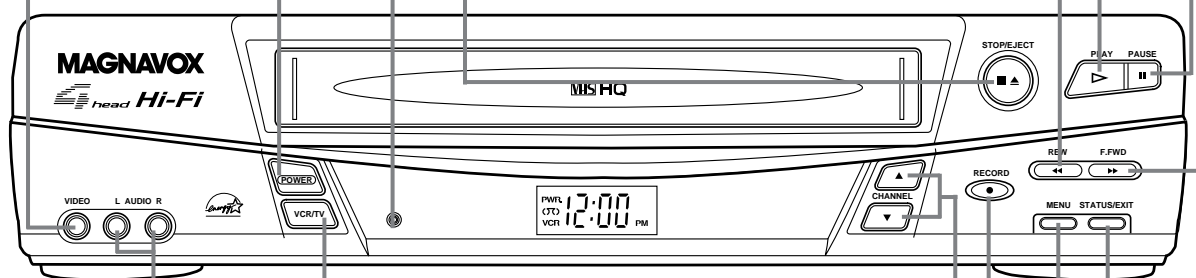

Rear Panel 25

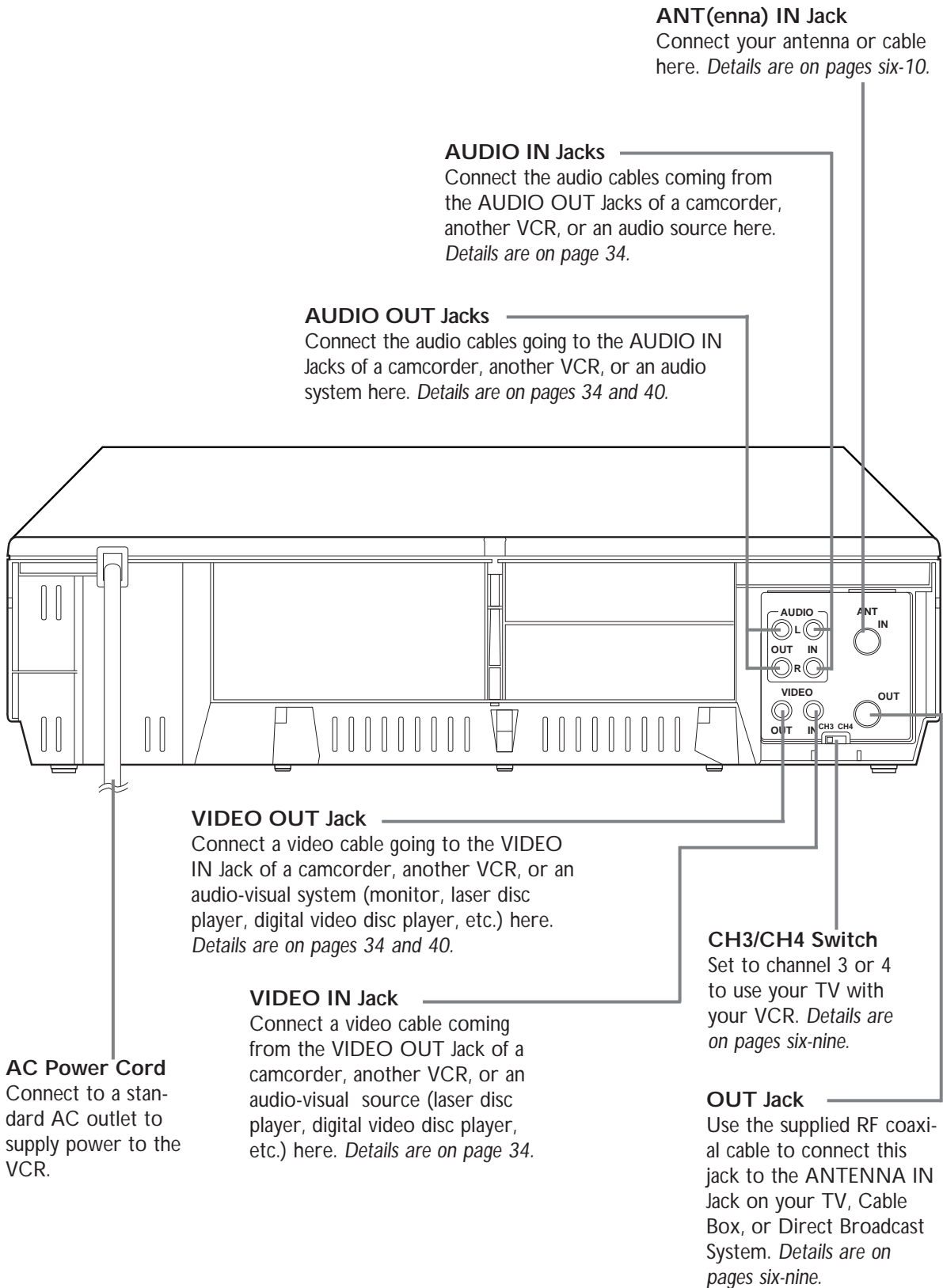

26 Playing

Read and follow the steps below to play a tape.

1

Turn on the TV and set it to channel 3 or 4, whichever channel the CH3/CH4 switch on the back of the VCR is set to.

2

Insert a tape in the VCR. The PWR., VCR, and Cassette-Inside lights will appear on the display panel. If the tape's record tab is missing, playback will start automatically.

3

If playback does not start automatically, press the VCR button, then press the PLAY/▲ button.

4

Press the STOP/▼ button to stop playback.

5

Press the REW(ind)/◀ button to rewind the tape.

6

Press the EJECT button to remove the tape.

1

Turn on the TV.

2

Insert a tape in the VCR.

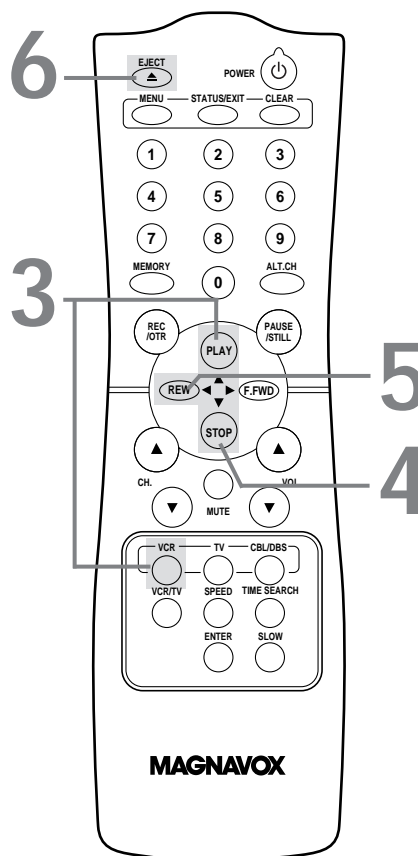

S-VHS Quasi Play Back (SQPB)

This unit has a SQPB function that allows you to view a tape recorded in S-VHS format. A tape recorded in S-VHS format will play the same as a tape recorded in normal format. This unit automatically detects whether the tape is recorded in S-VHS format or in normal format.

When you play a tape recorded in S-VHS format on this unit, you can not get the high resolution that would be available on an S-VHS VCR. Noise lines (black and white streaks) may appear on the picture.

Helpful Hints

- If the tape you want to play is already in the VCR, make sure the VCR power is on and the VCR is in VCR position. (The VCR light will appear on the display panel. If it does not, press the VCR/TV button once.) Press the VCR button, then press the PLAY/▲ button.
- Other playback options and features are on pages 35-42.
- If REPEAT PLAY is ON, playback will begin automatically when you insert a tape, even when the record tab is intact. Details are on page 35.
- Tape playback will not begin automatically if a timer recording is set and the VCR power is off. Details are on page 39.

Recording 27

Read and follow the steps below to record a television program.

1

Turn on the TV and set it to channel 3 or 4, whichever channel the CH3/CH4 switch on the back of the VCR is set to.

2

Insert a tape with its record tab intact in the VCR.

If playback begins, press the VCR button, then press the STOP/▼ button to stop the tape.

3

If the VCR light appears on the display panel, go to step 4. If the VCR light does not appear, press the VCR button, then press the VCR/TV button once.

4

Press the VCR button, then press the SPEED button repeatedly until the desired tape speed appears briefly on the screen. (Details about tape speed are on page 32.)

5

Use the CH(annel) ▲/▼ buttons or the Number buttons to select the channel you want to record.

6

Press the REC(ord)/OTR button once to start recording. The REC(ord) light will appear on the VCR display panel.

7

To pause the recording, press the PAUSE/STILL button once. The REC(ord) light will flash. To resume recording, press the REC(ord)/OTR button or press the PAUSE/STILL button again. The REC(ord) light will come on again.

8

To stop recording, press the STOP/▼ button.

1

 Turn on the TV.

2

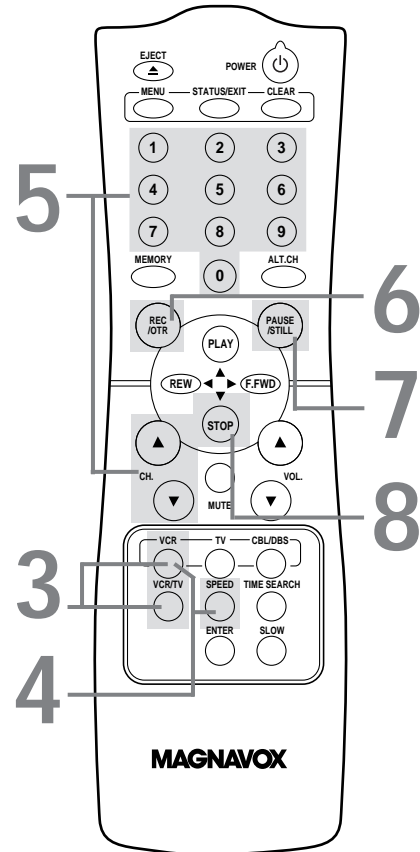
 Insert a tape in the VCR.

Helpful Hints

- If you press the REC(ord)/OTR button when there is not a tape in the VCR, NO CASSETTE will flash on the screen.
- If you press the REC(ord)/OTR button while a tape without a record tab is in the VCR, the VCR will eject the tape and PROTECTED CASSETTE CANNOT RECORD will flash on the screen.
- Other recording options are on pages 28-34.
- You can change the tape speed during a recording, but some distortion will appear on the tape.
- The VCR will record in a preset volume.

28 Recording One Channel/Watching Another

1

Press the VCR button.

2

Press the REC(ord)/OTR button to start a recording of the current channel. (See page 27.) The REC(ord) light will appear on the VCR display panel.

3

Press the VCR/TV button to put the VCR in TV position. The VCR light will disappear from the VCR's display panel.

4

Press the TV button, then press the CH(annel) ▲/▼ or Number buttons to select the channel you want to watch at the TV. (If the VCR remote control doesn't work your TV, use the TV remote control to select the channel.)

5

To return to the channel being recorded, press the TV button, then use the Number buttons to select channel 03 or 04 at the TV. (If the VCR remote control doesn't operate your TV, use the TV remote control to select channel 03 or 04.)

6

Press the VCR button.

7

Press the VCR/TV button to put the VCR in VCR position. The VCR light will appear on the display panel. The channel being recorded will appear on the screen.

8

Press the STOP/▼ button to stop the recording.

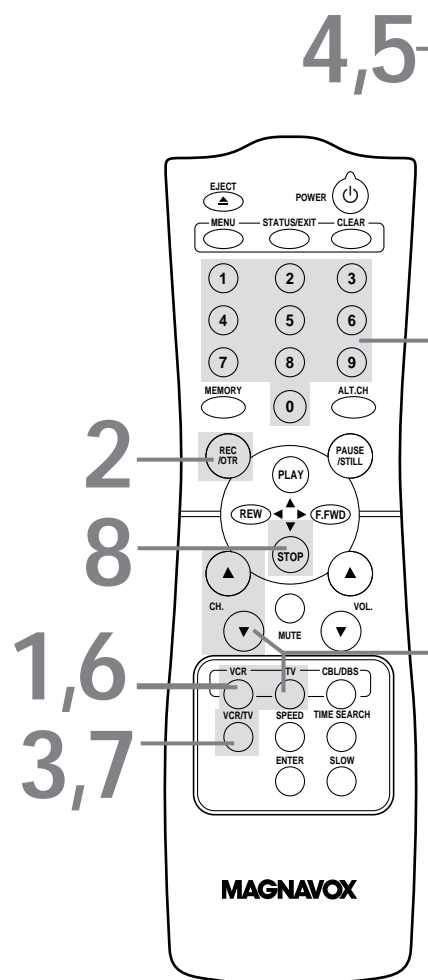

Helpful Hints

- If you use a Cable Box or Direct Broadcast System, you may not be able to watch one channel while recording another. See pages eight-nine for details.
- If your VCR remote control does not operate your TV, see page 18.

One-Touch Recording 29

The One-Touch Recording (OTR) feature allows you to set an immediate timed recording 30 minutes to eight hours long. Before you begin:

- Set up the channels at the VCR. *Details are on page 12.*
- Select a recording speed (SP, SLP) with the SPEED button.
- Put a tape in the VCR. Make sure the tape's record tab is intact and the tape is long enough to record the program(s). If the end of a tape is reached during an OTR, the VCR will eject the tape and turn itself off.
- Place the VCR in VCR position. (The VCR light will appear on the display panel. If it does not, press the VCR/TV button once.)

1

Press the VCR button, then press the CH(annel) ▲/▼ buttons or the Number buttons to select the channel you want to record.

2

Press the REC(ord)/OTR button repeatedly until the desired recording length (30 minutes to eight hours) appears on the screen. Recording will begin immediately. The REC(ord) light and the Timer light will appear on the display panel.

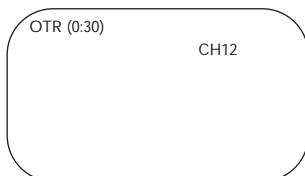

3

To stop an OTR before recording is finished, press the STOP/▼ button.

To cancel the OTR but continue recording, press the REC(ord)/OTR button repeatedly until REC appears in the upper left corner of the TV screen. (STATUS must be set to ON. See page 22 for details.) The REC(ord) light will remain on the display panel of the VCR, but the Timer light will disappear.

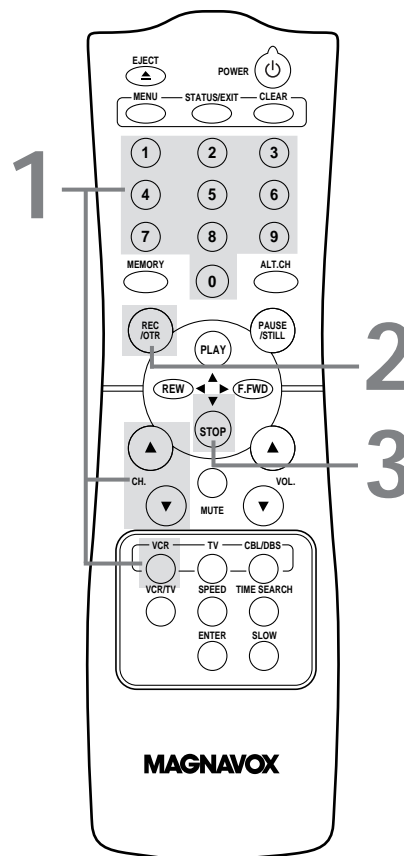

Helpful Hints

- To check the time remaining for an OTR after the OTR has been set, press the STATUS/EXIT button.
- To change the recording length while an OTR is in progress, press the REC(ord)/OTR button until the desired length appears on the screen.
- If you begin an OTR when another recording is paused, the OTR will begin.
- You can not pause an OTR.
- If the preset time for a timer recording comes up during an OTR, the OTR has priority. A message will remind you when the timer recording was scheduled to begin. You may let the OTR continue; the timer recording will not take place. Or, stop the OTR and turn off the VCR immediately. The timer recording will take place if you turn off the VCR before the timer recording's scheduled start time.
- When the OTR finishes, the VCR shuts itself off.

30 Timer Recording

Follow the steps below to program your VCR to record TV programs while you're away from home. The VCR will turn itself on, record, and turn itself off automatically. Before you begin:

- Set up the channels at the VCR. *Details are on page 12.*
- Set the clock. *Details are on page 15.*
- Put a tape in the VCR. Make sure the tape's record tab is intact and the tape is long enough to record the program(s).
- Make sure the VCR is in VCR position. The VCR light will appear on the display panel. If it does not, press the VCR button, then press the VCR/TV button once.

Do each step within 60 seconds of the previous step.

1

Press the **VCR** button, then press the **MENU** button.

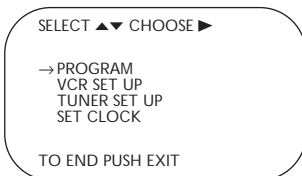

2

Press the **PLAY/▲** button or the **STOP/▼** button to select **PROGRAM**, then press the **F.FWD/▶** button.

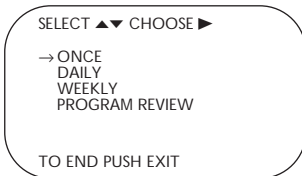

3

Press the **PLAY/▲** button or the **STOP/▼** button to select a **ONCE**, **DAILY**, or **WEEKLY** recording. Then, press the **F.FWD/▶** button.

- **ONCE:** The VCR will record a TV program on any day you choose, up to 12 months away.
- **DAILY:** The VCR will record the same channel every day from Monday to Friday – starting at the same time and recording for the same length of time.
- **WEEKLY:** The VCR will record the same channel on the same day, at the same time, and for the same length of time every week.

**Daily
Recording
(example)**

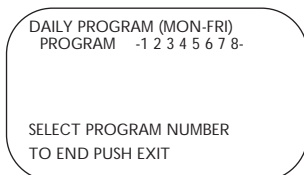

2-3

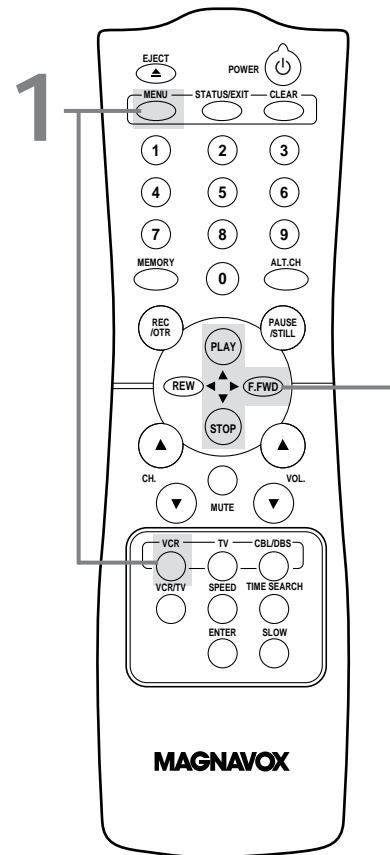

Helpful Hint

- If you need to make a correction while programming a timer recording, press the **CLEAR** button until the cursor is flashing on the item you want to change. Then enter the correct information.

4

Use the Number buttons (1-8) to select a slot in which to store the timer recording. There are eight slots. Numbers for open slots will flash on the screen.

NOTE: If you enter a number for a slot that has already been used to store a timer recording, PREVIOUSLY SET PROGRAM will appear on the screen briefly. Information about the program in that slot will appear on the screen. If this happens, press the STATUS/EXIT button, then select another number.

5

Use the Number buttons to enter the channel you want to record.

- Cable Users, enter channel numbers as a two-digit number for the quickest results. For example, to select channel 6, press 0,6. If you only press the Number 6 button, channel 6 will be selected after a brief delay. There also may be a brief delay when you select channels 10, 11, and 12. If you want to select channels 100 and above, enter channel numbers as a three-digit number. For example, to select channel 117, press 1, 1, 7.

Antenna Users, enter channel numbers as a two-digit number for the quickest results. For example, to select channel 5, press 0,5. If you only press the Number 5 button, channel 5 will be selected after a brief delay. You may only select channels 2-69.

- If you are recording from line input, press 0,0 to select AV REAR.
- If you are using a Cable Box/DBS, select the Cable Box/DBS output channel (03 or 04). Set the Cable Box/DBS to the channel you want to record. Leave the Cable Box/DBS on for the timer recording. See page eight for details.

6

Press two Number buttons for the hour you want the recording to begin. Press two Number buttons for the minute you want the recording to begin. Press 1 for AM or 2 for PM. For example, for 9:30 PM, press 09, 30, 2.

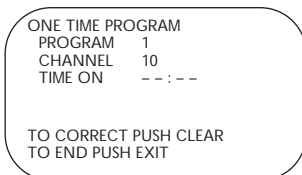

7

Follow the instructions in step 6 to enter the recording's stop time. (AM or PM will be set automatically.)

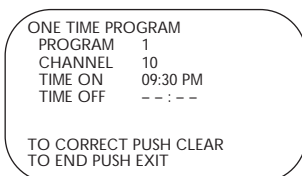

Instructions continue on page 32.

4-7

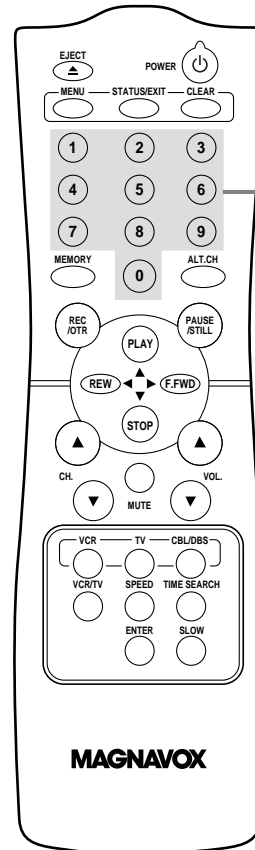

Helpful Hints

- Entries that do not match the VCR's clock or calendar will cause a question mark to appear on the screen.
- If you are recording from line input, connect the audio and video cables to the AUDIO IN and VIDEO IN jacks on the back of the VCR. (Please see illustration on page 34.)

32 Timer Recording (cont'd)

8

Press the **Number 1** button to record in **SP** speed or the **Number 2** button to record in **SLP** speed. (See the chart below.) You cannot use the **SPEED** button at this time.

| | |
|-----------------------|----------|
| ONE TIME PROGRAM | |
| PROGRAM | 1 |
| CHANNEL | 10 |
| TIME ON | 09:30 PM |
| TIME OFF | 11:00 PM |
| REC SPEED | SLP |
| SP=1 | SLP=2 |
| TO CORRECT PUSH CLEAR | |
| TO END PUSH EXIT | |

9

Press two **Number** buttons for the month and two **Number** buttons for the day you want to record the program. For example, for July 10, 2001, press 07, 10. The day of the week and the year will appear automatically (you cannot program the VCR to record more than one year in advance).

| | |
|-----------------------|----------|
| ONE TIME PROGRAM | |
| PROGRAM | 1 |
| CHANNEL | 10 |
| TIME ON | 09:30 PM |
| TIME OFF | 11:00 PM |
| REC SPEED | SLP |
| START DATE | 07/10/01 |
| | TUE. |
| TO CORRECT PUSH CLEAR | |
| TO END PUSH EXIT | |

10

Press the **STATUS/EXIT** button. PROGRAM WAS COMPLETED/PLEASE TURN OFF VCR FOR TIMER RECORDING will appear on the screen briefly. (If PROGRAM NOT COMPLETED appears, try again from step 1.)

11

Press the **POWER** button to turn off the VCR power. The Timer light will appear on the display panel. The Timer light will flash if there is no tape in the VCR.

If the timer recording will take place several hours or days from now, you may use the VCR until time for the recording. Turn off the VCR a few minutes before the recording starts. If you forget to turn off the VCR, PLEASE TURN OFF VCR FOR TIMER RECORDING flashes on your TV screen two minutes before a timer recording is set to begin. Press the **CLEAR** button to remove the message, then turn off the VCR.

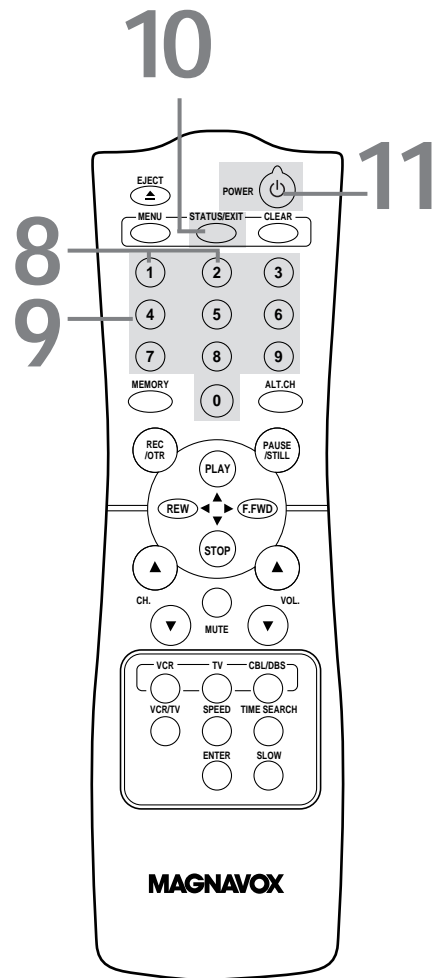

Turn off the VCR for the recording. Insert a tape in the VCR. Leave the Cable Box/DBS on (if applicable).

| Tape Speeds This chart shows the recording/playback time for three types of video cassettes (T160, T120, and T60). There are three playback speeds: SP, LP, and SLP. When recording, you can change the tape speed (SP or SLP) using the SPEED button. You cannot record in LP speed. You can play a tape only in the speed in which you recorded it. | Tape Speed | Cassette type/Playback Time | | |
|--|-----------------------------------|-----------------------------|--------|--------|
| | | T160 | T120 | T60 |
| | SP (standard play) | 2 hrs. 40 mins. | 2 hrs. | 1 hr. |
| | LP (long play) (playback only) | 5 hrs. 20 mins. | 4 hrs. | 2 hrs. |
| | SLP (super long play) | 8 hrs. | 6 hrs. | 3 hrs. |

Checking or Cancelling Timer Recordings

1

With the VCR on and in VCR position (the VCR light will appear on the display panel), **press the VCR button, then press the MENU button.**

2

Press the **PLAY/▲** button or the **STOP/▼** button to select PROGRAM, then press the **F.FWD/▶** button.

3

Press the **PLAY/▲** button or the **STOP/▼** button to select PROGRAM REVIEW, then press the **F.FWD/▶** button.

The timer recording information for the program in the lowest numbered slot will appear on the screen. If no timer recordings are set, nothing will happen when you press the **F.FWD/▶** button.

4

Press the **F.FWD/▶** button repeatedly to review all programmed timer recordings. If you don't press the **F.FWD/▶** button within 10 seconds, the VCR will automatically display information about the next programmed timer recording. This will continue until all timer recordings have been displayed. Then the menu will disappear.

5

To cancel the timer recording displayed, press the **CLEAR** button. Either the display will disappear or information about other timer recordings will appear. If you do not press any other buttons, the display will disappear after all timer recordings have been displayed.

6

Repeat steps 1-4 to make sure you have cleared the correct timer recording.

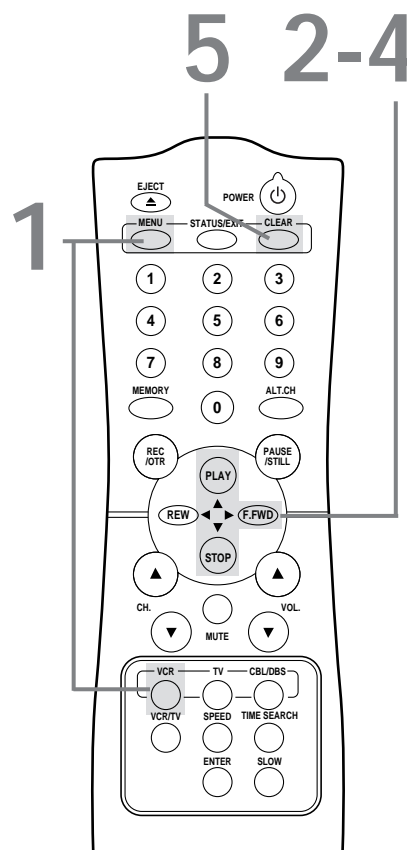

Helpful Hints

- CLASH may flash on the screen when you finish setting a timer recording. This means that the timer recording you just programmed and another timer recording overlap. The current timer recording will not take place. You may choose to cancel the overlapping timer recording.
- To stop a started timer recording, press the STOP/EJECT button on the VCR.
- The VCR may lose timer recordings if the power fails. Reset the channels and the clock before resetting the timer recordings. Details are on pages 11 and 15.
- If the preset time for a timer recording comes up during an OTR, the OTR has priority. A message will remind you when the timer recording was scheduled to begin. You may let the OTR continue; the timer recording will not take place. Or, stop the OTR and turn off the VCR immediately. The timer recording will take place if you turn off the VCR before the timer recording's scheduled start time.

See page 44 for more hints.

34 Rerecording (Tape Duplication)

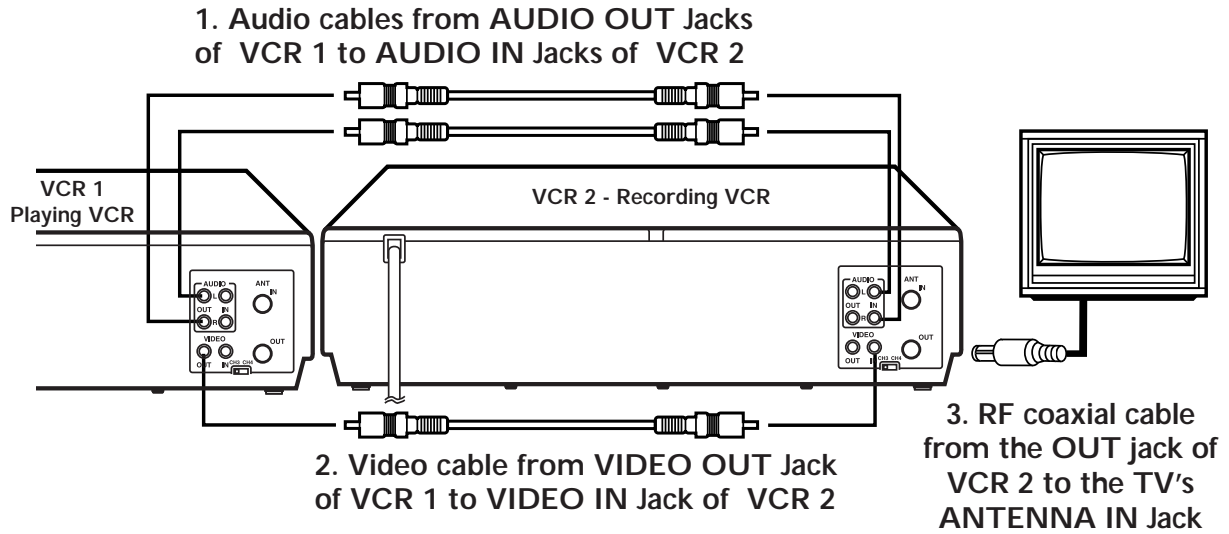

- Audio and Video cables are not supplied.

1

Make the connections shown above.

2

VCR 1 will play your tape. Put a prerecorded tape in VCR 1.

3

VCR 2 will record your tape. Insert a blank tape in VCR 2. The VCR must be in VCR position. (The VCR light will appear on the display panel. If it does not, press the VCR/TV button once.)

4

Turn on the TV and set it to channel 03 or 04, whichever channel the CH3/CH4 switch on VCR 2 is set to.

5

Point the remote control at VCR 2. Press the VCR button, then press the Number buttons 0, 0, 1 or 0, 0, 2. (See Helpful Hints at right.)

6

Press the SPEED button to select SP or SLP at VCR 2.

7

Press the PLAY button on VCR 1 and the RECORD button on VCR 2 at the same time.

To stop recording, press the STOP/EJECT button on VCR 1, then press the STOP/EJECT button on VCR 2.

Helpful Hints

- If you use the AUDIO and VIDEO IN Jacks on the back of VCR 2, press Number buttons 0, 0, 1 at step 5. AV REAR will appear on the TV screen.
- If you use the AUDIO and VIDEO In Jacks on the front of VCR 2, press Number buttons 0, 0, 2 at step 5. AV FRONT will appear on the TV screen.
- Unauthorized recording of copyrighted television programs, video tapes, or other materials may infringe on the rights of copyright owners and violate copyright laws.
- If a program has copyright protection, it may not record clearly.
- These instructions show you how to copy tapes using two VCRs like yours. Different VCRs may operate differently.

Repeat Play 35

Follow the steps below to make the VCR play a tape over and over.

1

Press the **VCR** button, then press the **MENU** button.

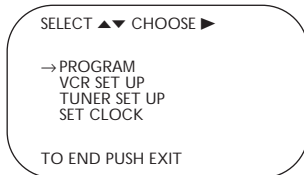

2

Press the **PLAY/▲** button or the **STOP/▼** button to select **VCR SET UP**, then press the **F.FWD/▶** button.

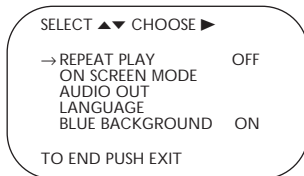

3

Press the **PLAY/▲** button or the **STOP/▼** button to select **REPEAT PLAY**.

4

Press the **F.FWD/▶** button so that **ON** appears beside **REPEAT PLAY**.

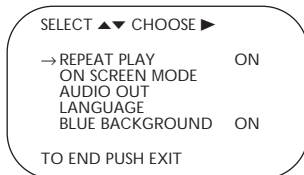

5

Press the **STATUS/EXIT** button. Now, when a tape has finished playing, the VCR will rewind it and start playback again.

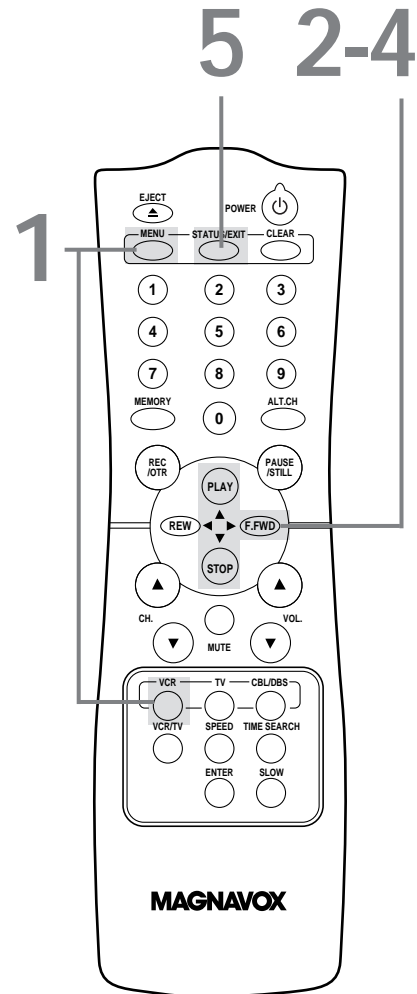

Helpful Hints

- To cancel Repeat Play, follow steps 1-3 above. At step 4, press the **F.FWD/▶** button so that **OFF** appears beside **REPEAT PLAY**. Press the **STATUS/EXIT** button.
- The real-time counter memory does not function during Repeat Play.

36 Real-Time Counter Memory

Follow the steps below to reset the real-time counter to zero at a tape location you want to refer to later.

1

Press the VCR button.

2

Play, fast forward, or rewind a tape to the location that you would like to refer to later. Press the STOP/▼ button to stop the tape.

3

Press the STATUS/EXIT button to see the status display.



4

While the status display is on the screen, press the CLEAR button to reset the real-time counter to zero.

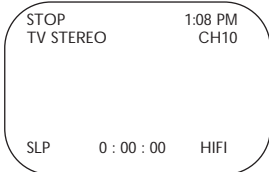

5

While the real-time counter is on the screen, press the MEMORY button so that M appears beside the counter.

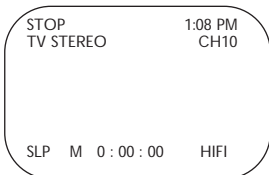

6

To go to a tape location where the real-time counter was reset to zero, press the REW(ind)/◀ button or the F.FWD/▶ button when playback is stopped.

When the tape reaches the point at which the counter was set to zero, the tape will stop.

Press the PLAY/▲ button to watch the tape.

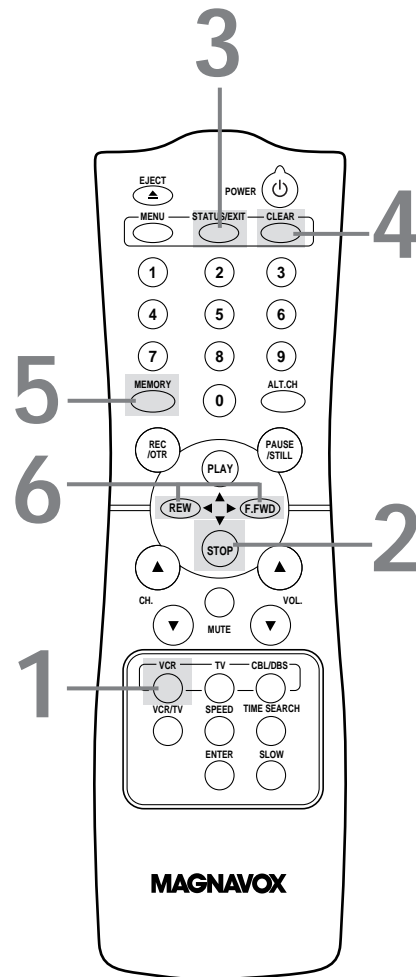

Helpful Hints

- The MEMORY button does not function if REPEAT PLAY is ON. Details are on page 35.
- To erase a real-time counter memory, press the MEMORY button until the M disappears from the screen.
- You may only set the real-time counter to zero at one location at a time. Setting the real-time counter to zero at a second location will erase the previous real-time counter to zero setting.

Time Search 37

Follow the steps below to program the VCR to search forward or backward on a tape a specific length of time. There must be a tape in the VCR.

1

Press the VCR button, then press the TIME SEARCH button.

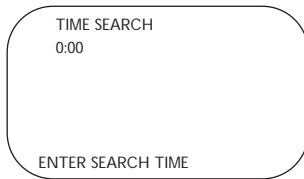

2

Within 10 seconds, use the Number buttons to enter the desired length of time you want to skip forward or backward. For example, for 1 hour, 25 minutes, press Number buttons 1, 2, 5. Or, for five minutes, press Number buttons 0, 0, 5.

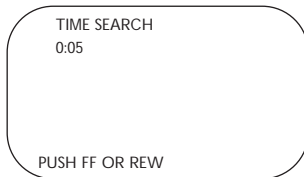

3

Within 10 seconds, press the F.FWD/▶ button or the REW(ind)/◀ button. The VCR will skip over the specified length of time, then begin playback.

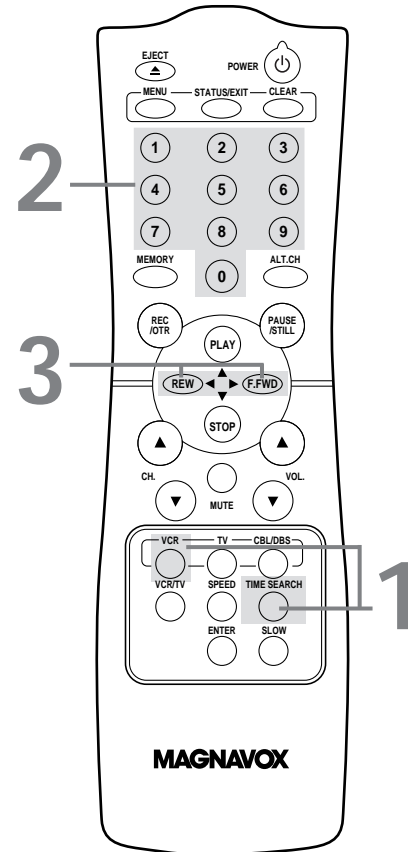

Helpful Hints

- If you want to search for more than 59 minutes, you must enter the length of time in hours and minutes. For example, to search forward 70 minutes, press 1,1,0 at step 2.
- You can not do a Time Search while recording.
- To remove the Time Search display, press the TIME SEARCH button again.
- To cancel a Time Search that is in progress, press the STOP/▼ button.

38 Special Effects Playback

Forward and Reverse Searching (SP/LP/SLP)

1

During tape playback, press and release the F.FWD/▶ button or the REW(ind)/◀ button. A fast forward or reverse picture search will begin.

2

To return to playback, press the PLAY/▲ button.

Super High Speed Searching (LP/SLP)

1

During tape playback, press the F.FWD/▶ button or the REW(ind)/◀ button, then press again. The VCR will now search in super high speed. Press the F.FWD/▶ button or the REW(ind)/◀ button repeatedly to switch between regular searching and super high speed searching.

2

To return to normal playback, press the PLAY/▲ button.

Viewing a Still Picture

1

During tape playback, press the PAUSE/STILL button. A still picture will appear on the screen.

2

To release the still picture and return to playback, press the PLAY/▲ button or press the PAUSE/STILL button again.

Viewing a Slow Motion Picture

1

During tape playback, press the SLOW button. The tape will play in slow motion.

2

To release Slow mode and return to normal playback, press the PLAY/▲ button or press the SLOW button again.

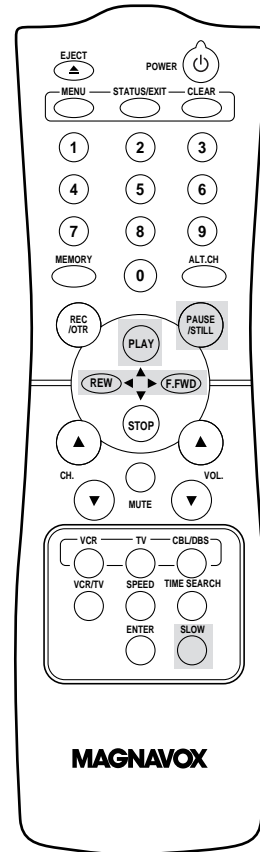

Helpful Hints

- Slow and Still modes will automatically switch to Stop mode after five minutes to protect the VCR and the tape from damage.
- SP/LP/SLP means this feature will work with tapes recorded in Standard Play, Long Play, or Super Long Play.
- LP/SLP means this feature will work with tapes recorded in Long Play or Super Long Play. For details about tape speed, see pages 32 and 48.
- Tapes recorded in SLP will have the clearest still picture and slow motion playback.

Automatic Operation Features 39

The following playback features will always operate.

Automatic Playback

When you put a tape in the VCR, the power will come on automatically. If the tape's record tab is missing, playback will begin. If a timer recording is set, the power will not come on automatically when you insert a tape with the record tab intact. If a timer recording is set and the VCR power is off, the VCR will eject the tape if the record tab is missing.

Automatic Rewind, Eject, Off

When you play, fast forward, or record a tape to its end, the VCR will rewind the tape to the beginning, stop, eject the tape, then turn itself off. If the real-time counter memory is set, the VCR will only rewind the tape to the point at which the counter is set to zero, then stop. The VCR will not eject the tape automatically or shut itself off. If REPEAT PLAY is set to ON, the VCR will not eject the tape automatically or shut itself off. Playback will continue as set for Repeat Play.

Tape Eject

You can eject a tape with the VCR power on or off (but the VCR must be plugged in). If you have set a timer recording, you can only eject a tape with the VCR power on. Make sure you insert a tape and turn off the VCR power for the timer recording.

Automatic Tracking Adjustment

The VCR adjusts tracking automatically to give you the best possible picture quality. With some recordings, however, you may get a better picture using the manual tracking controls (see below).

Manual Tracking

To manually adjust the tracking during normal playback and slow motion playback, press the CHANNEL ▲/▼ buttons **on the VCR**. (The CH(annel) ▲/▼ buttons on the remote control will not adjust tracking.)

Tracking will return to Automatic Tracking Adjustment when you press the STOP/▼ button or insert a tape.

You cannot manually adjust the tracking of a Still picture.

However, you may press the CHANNEL ▲/▼ buttons on the VCR to remove vertical jitter in a Still picture.

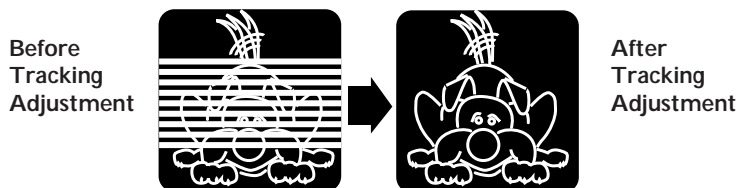

40 Multi-Channel Television Sound System

Your VCR can play recordings broadcast in Hi-Fi (high fidelity) stereo, which produces a crisp, clear sound from two sources. Your VCR also can play tapes recorded in a second audio (usually, that means your program is recorded in a second language). Of course, your VCR will play tapes recorded in monaural (single-source) sound as well.

Your VCR also will record in Hi-Fi stereo or in second audio, so when you play that tape on the VCR, it will be in stereo or second audio.

Read the directions on this page to familiarize yourself with your VCR's stereo and second audio setups. Then follow the directions on page 41 to record in stereo or second audio and the directions on page 42 to play tapes recorded in Hi-Fi stereo.

Understanding On-Screen Displays

When you receive a signal from a channel you're watching, portions of the on-screen display shown below will appear when you press the STATUS/EXIT button on the remote control.

The indication 2ND AUD or TV STEREO that appears on this side of the status display tells you if your VCR is receiving a second audio or stereo broadcast. Although a program may be broadcast in both stereo and second audio, you cannot record in both stereo and second audio at the same time.

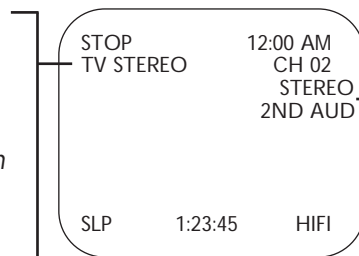

The indication 2ND AUD or STEREO that appears on this side of the status display tells you if the program you're watching is available in second audio or stereo. This indication is not available during tape playback. Even though a program is available in stereo or second audio, you still must program the VCR to receive or record the program. Follow the directions on page 41.

To record and play programs broadcast in stereo, even if you have a single-speaker TV, just use one of the connections shown, then follow the steps on pages 41-42.

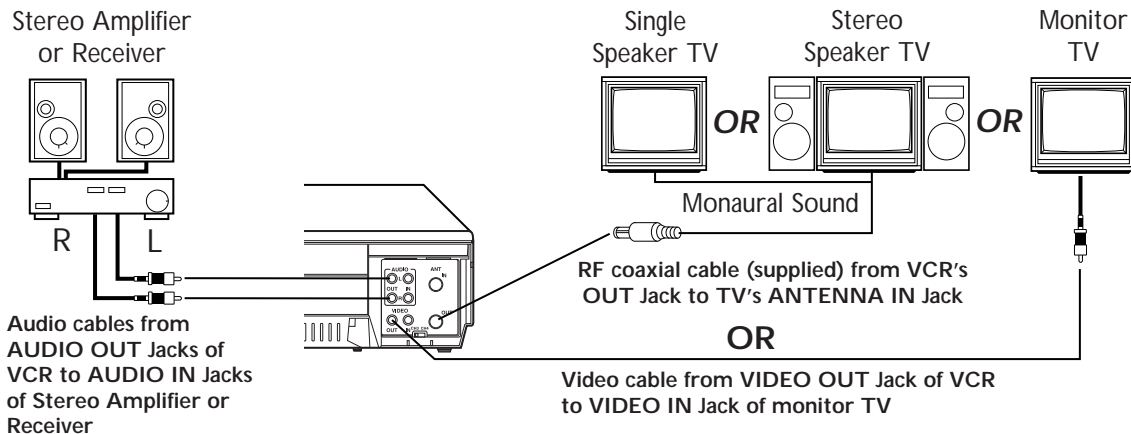

Multi-Channel Television Sound System (cont'd) 41

1

Press the VCR button, then press the MENU button.

SELECT ▲▼ CHOOSE ►

→ PROGRAM
VCR SET UP
TUNER SET UP
SET CLOCK

TO END PUSH EXIT

2

Press the PLAY/▲ button or the STOP/▼ button to select TUNER SET UP, then press the F.FWD/► button.

SELECT ▲▼ CHOOSE ►

→ AUTO PROGRAMMING
ADD/DELETE CH
CH MEMORY REVIEW
TV STEREO ON
2ND AUDIO

TO END PUSH EXIT

3

Press the PLAY/▲ button or the STOP/▼ button to select TV STEREO or 2ND AUDIO. Then, press the F.FWD/► button. ON will appear to the right of your selection.

SELECT ▲▼ CHOOSE ►

AUTO PROGRAMMING
ADD/DELETE CH
CH MEMORY REVIEW
TV STEREO ON
→ 2ND AUDIO

TO END PUSH EXIT

4

Press the STATUS/EXIT button.

5

To record, select the channel to be recorded using the CH(annel) ▲/▼ buttons, then go to step 6.

6

Press the REC(ord)/OTR button to start recording.

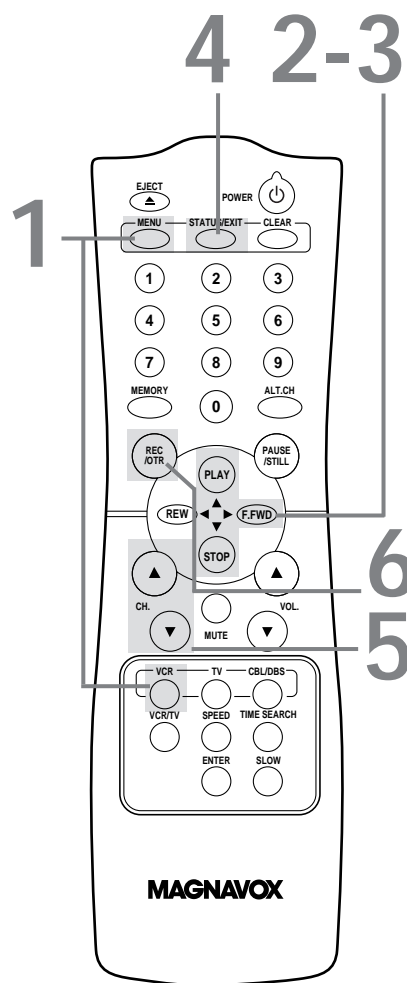

Helpful Hints

- You can only receive and record in stereo or second audio programs that are broadcast in stereo or second audio. You can only play in stereo or second audio tapes that were recorded in stereo or second audio. Please see page 40 to determine if the program you want to watch/record is being broadcast in stereo or second audio.
- If you select second audio when second audio is not available, the VCR will record normal audio.

42 Hi-Fi Stereo Sound System

Multi-Channel Television Sound system broadcasts are automatically recorded in Hi-Fi stereo sound. To play in Hi-Fi stereo the tapes recorded in Hi-Fi stereo, however, you'll need to follow steps 1-5.

1

Press the **VCR** button, then press the **MENU** button.

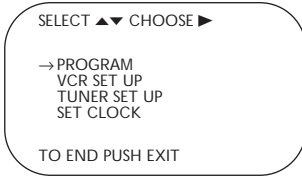

2

Press the **PLAY/▲** button or the **STOP/▼** button to select **VCR SET UP**, then press the **F.FWD/▶** button.

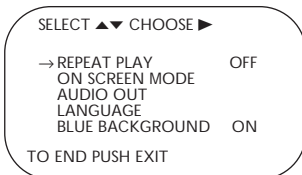

3

Press the **PLAY/▲** button or the **STOP/▼** button to select **AUDIO OUT**, then press the **F.FWD/▶** button.

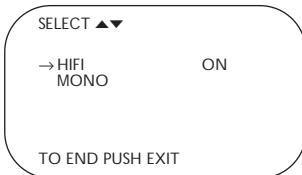

4

Press the **PLAY/▲** button or the **STOP/▼** button to select **HIFI**. ON will appear to the right of HIFI on the screen.

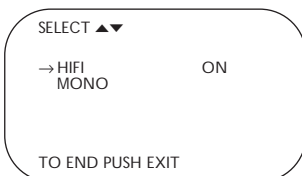

5

Press the **STATUS/EXIT** button.

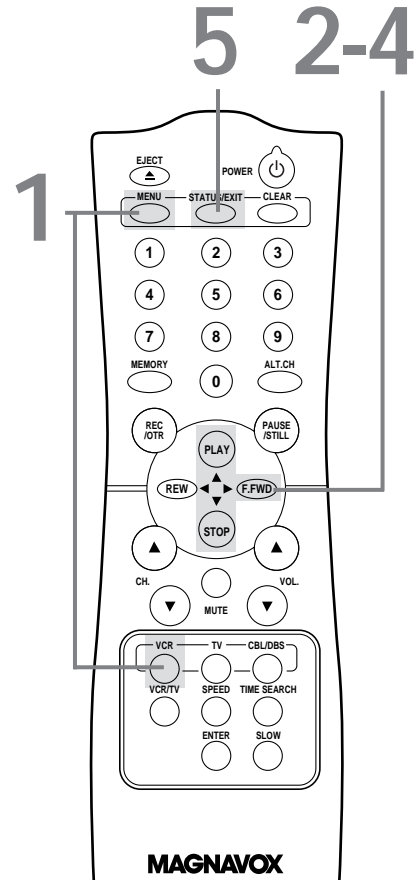

Helpful Hints

- Normally, HIFI should be selected from the AUDIO OUT menu for playback with Hi-Fi sound. But, you can change the selection to MONO if you want monaural audio playback. To do this, follow steps 1-3. At step 4, press the **PLAY/▲** button or the **STOP/▼** button to select MONO. Press the **STATUS/EXIT** button. HIFI will disappear from the status display.
- All programs are automatically recorded in both Hi-Fi stereo sound and in monaural sound.
- The audio level of a tape recorded in HIFI will differ from the audio level of a tape recorded in MONO.
- If you play non-Hi-Fi tapes while the VCR is set to HIFI, HIFI will disappear from the status display and the tape will play in monaural sound. Please see additional notes on page 45.

Blue Background 43

If you want the TV screen to be solid blue when a weak signal is received, set BLUE BACKGROUND to ON. The screen will be blue and the sound will be muted.

Or, if you want to receive the weak signal, set BLUE BACKGROUND to OFF. When you select a channel that is receiving a weak signal, you will see the static in the TV programming. The channel number will not appear on the screen when you select a weak channel, and you can not access the VCR's status display. Also, you may not be able to adjust the volume.

To set BLUE BACKGROUND to ON or OFF, follow these steps.

1

Press the VCR button, then press the MENU button.

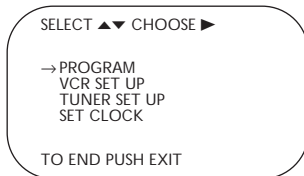

2

Press the PLAY/▲ button or the STOP/▼ button to select VCR SET UP, then press the F.FWD/► button.

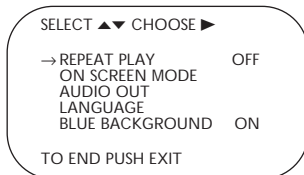

3

Press the PLAY/▲ button or the STOP/▼ button to select BLUE BACKGROUND. Then, press the F.FWD/► button repeatedly so that OFF (or ON) appears beside BLUE BACKGROUND.

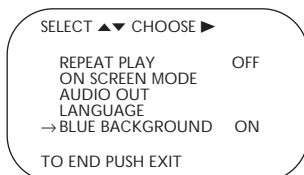

4

Press the STATUS/EXIT button.

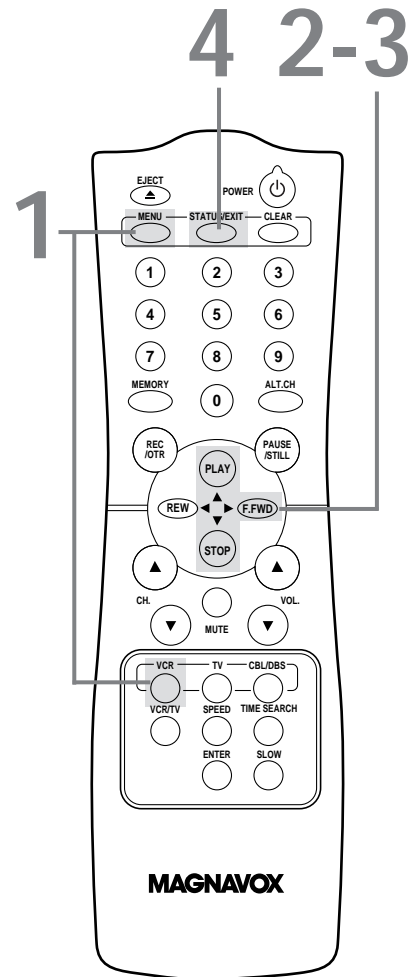

44 Helpful Hints

If you are having problems with your product, check this list of problems and possible solutions before requesting service. You may be able to solve the problem yourself.

If you need to call a customer service representative, please know the model number and serial number of your product before you call. This information appears on the back of the product. Also, please take a moment to identify the problem you are having, and be prepared to explain this to the representative. If you believe the representative will need to help you with operations, please stay near the product. Our representatives will be happy to assist you.

No power

- Connect the power plug completely to an AC (alternating current) outlet.
- Turn on the power.

Power Failure

- The VCR may lose timer recordings, the clock and channel settings, and the language selection if the power fails. Follow the steps on pages 11 and 15 to reset the language, channels, and clock. Then, see pages 30-32 to reprogram your timer recordings.

The VCR will not record a TV program.

- Check the connections between the VCR, TV, antenna/cable, and Cable Box/Direct Broadcast System (if applicable). *Details are on pages six-10.*
- Make sure the tape has a record tab. *Details are on page five.*
- Check the TV/VCR position. *Details are on page 24.*
- Check the CH3/CH4 switch. *Details are on pages six-nine.*

The VCR will not perform a timer recording.

- Make sure you set the recording start and stop times correctly. *Details are on pages 30-33.*
- Make sure a tape is in the VCR and the tape has a record tab (page five). If, after programming a timer recording, you turn off the VCR power without putting a tape in the VCR, the Timer light will blink.
- If the record tab on a tape is missing, the VCR will eject the tape. The Timer light will blink.
- Make sure the VCR power is off.
- Make sure you have set the clock correctly. *Details are on page 15.*
- The VCR may not perform or continue a timer recording if the power fails.
- If you have a Cable Box/Direct Broadcast System, you will program timer recordings differently. *Details are on page eight.*
- Finish programming a timer recording at least five minutes before the recording should begin.
- 12 p.m. is noon; 12 a.m. is midnight.

There is no playback picture or the playback picture is noisy or contains streaks.

- Make sure the TV is on the same channel as the VCR's CH3/CH4 switch.
- Make sure the VCR is in VCR position. (The VCR light will appear on the display panel.)
- Adjust channel 03 or 04 at the TV.
- Adjust the tracking. *Details are on page 39.*
- TVs that are too close to the VCR can cause interference during tape playback. Move the VCR away from the TV.

The remote control will not operate the VCR.

- Press the VCR button, then try the other VCR feature buttons.
- Make sure the VCR light appears on the display panel. If it does not, press the VCR/TV button once.
- Aim the remote control directly at the VCR's remote sensor. *Details are on page 24.*
- Remove all obstacles between the remote control and the VCR.
- Inspect and/or replace the batteries in the remote control. *Details are on page five.*

The Number buttons won't work for channels above 69.

- Enter channel numbers as a two-digit number. If you want to select channels 100 and above, enter channel numbers as a three-digit number. If you are using an antenna (not a cable signal), you may only select channels 2-69. *Details are on page 20.*

You cannot watch TV programs normally.

- Put the VCR in TV position, then change channels at the TV. (Press the VCR/TV button so that the VCR light disappears from the display panel. *Details are on page 24.*)
- Check the connections between the VCR, TV, antenna/cable, and Cable Box/Direct Broadcast System (if applicable). *Details are on pages six-10.*

You can not insert a tape.

- Insert the tape, window side up, with the record tab facing you.
- Make sure a tape isn't already in the VCR by pressing the STOP/EJECT button on the VCR.
- Gently push on the center of the tape when putting it in the VCR. Never force the tape into the VCR.
- If you have programmed a timer recording and the VCR power is off, you can not insert a tape without a record tab.

You can not remove a tape.

- Connect the power plug to a power outlet.
- You have set a timer recording. Turn on the VCR power, then eject the tape. Be sure to insert a tape and turn off the power for your timer recording.

VCR ejects the tape when you press the REC(ord)/OTR button or when you turn off the VCR power for a timer recording.

- Make sure the tape has a record tab. *Details are on page five.*

Poor reception

- You may need to tune your TV again.

The motor (cylinder) rotates even when the VCR is in Stop mode.

- To enable the quick play mechanism, the cylinder will rotate for about five minutes. This is normal. The quick play mechanism allows the tape mechanism to switch from Stop mode to Play mode in one second.

Direct Broadcast System Hookups

- Watching one TV channel while recording another may not be possible if you have a DBS hookup. You may have to set your TV to channel 03 or 04, then make your channel selections at the DBS.
- If you use audio and video cables to connect your DBS, VCR, and TV, you may have to put your VCR in Line Input mode (channel 001 or 002).

Line Input mode

- If you accidentally enter Line Input mode (AV FRONT or AV REAR will appear on your TV screen briefly), press the CH(annel) ▲/▼ buttons or use the Number buttons to select another channel.

Hi-Fi Stereo Sound

- During playback, Hi-Fi audio may temporarily revert to normal audio when you adjust tracking. This is normal.
- When connecting the VCR to a stereo TV, you will only get stereo sound if you use audio cables to connect the AUDIO OUT jacks on the VCR to the AUDIO IN jacks on your TV, and if the TV is in Line (Auxiliary) Input mode.
- When you connect the AUDIO OUT jacks on the VCR to the AUDIO IN jacks on your TV, the stereo light on the TV might not glow. But, as long as the status display indicates you are receiving a stereo signal, you are receiving a stereo signal. This is normal.
- Only tapes recorded in Hi-Fi audio will play back in Hi-Fi audio. Tapes recorded in normal audio will play back in monaural audio.

Cleaning the Video Heads

- Your VCR automatically cleans the video heads each time you insert a tape. However, the heads may become dirty. If so, use a commercially-available head cleaner or have an authorized servicer clean the video heads. Eventually, you may need to replace the heads.

The playback picture is too dim, too bright, or fluctuates in brightness.

- Some programs may be broadcast with copyright protection technology in order to protect the rights of copyright owners. This technology is used on programs that are recorded on video tapes or Digital Video Discs (DVDs), as well as some programs broadcast by antenna/cable/satellite television channels. Programs broadcast with copyright protection technology may not record clearly. Likewise, if you play a tape that is a recording of a copyright protected program, the picture may not be clear. Tapes of copyright protected programs may have a picture that is dark or dim, or the brightness of the picture may fluctuate. Therefore, you should avoid recording or playing copies of copyright protected programs. This VCR incorporates copyright protection technology that is protected by method claims of certain U.S. patents and other intellectual property rights owned by Macrovision Corporation and other rights owners. Use of this copyright protection technology must be authorized by Macrovision Corporation and is intended for home and other limited viewing uses only, unless otherwise authorized by Macrovision Corporation. Reverse engineering or disassembly is prohibited.

46 Limited Warranty

VIDEO CASSETTE RECORDER or PLAYER

90 days Free Exchange / 91 days–One Year Reduced-Cost Exchange

WHO IS COVERED?

You must have proof of the date of purchase to exchange your product. A sales receipt or other document showing the date that you purchased the product is considered such proof.

WHAT IS COVERED?

Warranty coverage begins the day you buy your product. For 90 days thereafter, you may exchange the defective product for a new product at the store from which it was purchased or through Philips. This exchange is made at no cost to you. From 91 days to one year from the date of purchase, you must follow the exchange procedures set out on the next page. For an exchange during this warranty period you must pay \$29.95 (plus your local sales tax) for a new or renewed product. This reduced-cost exchange ends one year after the date of purchase.

The replacement product is covered only for the warranty period of the original product. When the warranty on the original product expires, the warranty on all replaced products also expires.

WHAT IS EXCLUDED?

Your warranty does not cover:

- labor charges for installation or setup of the product, adjustment of customer controls on the product, and installation or repair of antenna systems outside of the product.
- product repair and/or part replacement because of misuse, accident, unauthorized repair or other cause not within the control of Philips Consumer Electronics.
- reception problems caused by signal conditions or cable or antenna systems outside the product.
- a product that requires modification or adaptation to enable it to operate in any country other than the country for which it was designed, manufactured, approved and/or authorized, or repair of products damaged by these modifications.
- incidental or consequential damages resulting from the product. (Some states do not allow the exclusion of incidental or consequential damages, so the above exclusion may not apply to you. This includes, but is not limited to, prerecorded material, whether copyrighted or not copyrighted.)
- damage caused by the use of non-VHS tapes or tapes that have not been tested and labeled for use in two, four, six, and eight hour VHS recorders.
- a product that is used for commercial or institutional purposes (including but not limited to rental purposes).

WHERE IS EXCHANGE AVAILABLE?

Warranty exchange is available in all countries where the product is officially distributed by Philips Consumer Electronics. In countries where Philips Consumer Electronics does not distribute the product, the local Philips service

organization will attempt to exchange the product, although there may be a delay if the appropriate product is not readily available.

MAKE SURE YOU KEEP...

Please keep your sales receipt or other document showing proof of date of purchase. Attach it to the owner's manual and keep both nearby. Also keep the original box and packing material in case you need to return your product.

BEFORE EXCHANGING THE PRODUCT...

Please check your owner's manual before exchanging the product. Adjustments of the controls discussed there may save you time and money.

TO EXCHANGE YOUR PRODUCT IN THE U.S.A., PUERTO RICO, OR U.S. VIRGIN ISLANDS...

Follow the instructions stated previously in the "What is Covered" section, or refer to the exchange instructions on the next page.

In the U.S.A., Puerto Rico, and U.S. Virgin Islands, all implied warranties, including implied warranties of merchantability and fitness for a particular purpose, are limited in duration to the duration of this express warranty. Because some states do not allow limitations on how long an implied warranty may last, this limitation may not apply to you.

TO EXCHANGE A PRODUCT IN CANADA...

Please contact Philips at:

1-800-661-6162 (French Speaking)

1-800-363-7278 (English Speaking)

In Canada, this warranty is given in lieu of all other warranties. No other warranties are expressed or implied, including any implied warranties of merchantability or fitness for a particular purpose. Philips is not liable under any circumstances for any direct, indirect, special, incidental, or consequential damages, howsoever incurred, even if notified of the possibility of such damages.

TO GET OUT-OF-WARRANTY EXCHANGE...

In the U.S.A., Puerto Rico, or U.S. Virgin Islands, contact Philips Service Solutions Group at 1-800-531-0039 to obtain the cost of out-of-warranty exchange.

REMEMBER...

Please record below the model and serial numbers found on the product. Also, please fill out and mail your warranty registration card promptly. It will be easier for us to notify you if necessary.

MODEL # _____

SERIAL # _____

This warranty gives you specific legal rights. You may have other rights which vary from state to state.

Philips Service Solutions Group, P.O. Box 2976, Longview, Texas 75606, (903) 242-4800

Limited Warranty (cont'd) 47

EXCHANGE INSTRUCTIONS

If your product is defective, you may be able to exchange it at the store from which it was purchased. Most stores display a Return Policy. If not, ask the manager or sales associate how many days you have to exchange a product with them. After the store's return period has expired, you may exchange the product with Philips if you have your original sales receipt.

To exchange your product with Philips (per the warranty conditions stated previously), remember:

- If you exchange the product within 90 days of the original purchase, there is no cost to you.
- If you exchange the product more than 90 days after but less than one year after the day of original purchase, your cost will be \$29.95 plus your local sales tax. If sales tax is missing or incorrect, your order will be delayed, and you will be contacted.
- After 12 months from the day of original purchase, contact Philips Service Solutions Group at 1-800-531-0039 for information regarding out-of-warranty exchange.
- If you do not have your original sales receipt, or if you have any questions, call Philips Service Solutions Group at 1-800-531-0039.

To obtain a replacement product from Philips:

1. Complete the Exchange Form below.
2. Pack the product and its accessories (remote control, rf coaxial cable, owner's manual, and car battery cord, if applicable) in the original box or a suitable alternative. You will receive replacement accessories with your replacement product. For packing details, call 1-800-531-0039.
3. Put the completed Exchange Form, a copy of the original sales receipt, and the proper payment in an envelope. Do not staple or clip these items together. Label the envelope "Return Documents Enclosed." Place this envelope in the box with the product.
4. Seal the box with packing tape and return the product via United Parcel Service (UPS), insured and freight pre-paid, to:

Philips Recovery Center
Rojas 6
12420 Mercantile Avenue
El Paso, TX 79928
ATTENTION: VCR EXCHANGE

A replacement will be sent to you via UPS within 48 business hours of Philips' receipt of the product.

EXCHANGE FORM

Your Address (street address to which replacement should be delivered, no P.O. boxes allowed):

Name: _____

Street Address: _____

Apt. #: _____

City: _____

State: _____

Zip Code: _____

Phone (day): _____

Phone (night): _____

Payment Amount: \$29.95 + Sales Tax _____ = **Total** _____

Method of Payment: (Check one. Please, no cash or CODs.)

_____ Check or money order Check/Money order number _____

| | Account number | Expiration date |
|------------------------|----------------|-----------------|
| _____ American Express | _____ | _____ |
| _____ Visa | _____ | _____ |
| _____ Novus/Discover | _____ | _____ |
| _____ Mastercard | _____ | _____ |

Signature: _____

Detailed reason for return, use additional paper if necessary: _____

Model Number _____ Serial Number _____

Remember, the return box should include the following:

- The product,
- Accessories supplied with the product, and
- Completed Exchange Form and sales receipt,
- Payment, if applicable.

48 Glossary / Specifications

Glossary

AUDIO IN/OUT Jacks: jacks on the front and back of the VCR that record audio from another source (IN) or send audio to another system (OUT).

Automatic Channel Setup: process in which the VCR memorizes all available channels. Then, when you press the CH(annel) ▲/▼ buttons, you only scan through channels you receive.

Bands: settings that allow you to tune channels.

- **Antenna** – VHF (very high frequency; channels 2-13) and UHF (ultra high frequency; channels 14-69).
- **Cable** – all standard channels can be received without a Cable Box.

Cable Box/DBS Output Channel: 03 or 04.

Dubbing: copying a tape using a second VCR.

Frame: a still picture.

HQ: high quality; a feature in the VCR circuitry which provides enhanced picture detail.

Line Input: The channel to which you set your VCR during dubbing. If you use the AUDIO and VIDEO In jacks on the front of the VCR, select channel 002 (AV FRONT). If you use the AUDIO and VIDEO IN jacks on the back of the VCR, select 001 (AV REAR). If you accidentally enter Line Input mode, press the CH(annel) ▲/▼ buttons or use the Number buttons to select another channel.

OTR: One-Touch Recording; a timed recording that starts immediately and records for 30 minutes to eight hours.

Remote Control: the small electronic unit that came with your VCR; allows you to operate your VCR from a distance.

RF coaxial cable: The black cable supplied with your VCR. Use it to connect your VCR to your TV (or Cable Box or DBS). The supplied cable is a snap-on type. However, you may use a screw-on type if you prefer.

Special Effects: forward and reverse searching; a still picture; slow motion playback.

Tape Speeds: how fast the tape travels during a recording or playback.

- **SP** (standard play) – fastest tape speed (recording time for a T120 tape is approximately two hours); best picture quality.
- **LP** (long play) – average tape speed; playback only.
- **SLP** (super long play) – slowest tape speed (recording time for a T120 tape is approximately six hours).

VCR: video cassette recorder.

VIDEO IN/OUT Jacks: jacks on the front and back of the VCR that record video from another source (IN) or send video to another system (OUT).

Specifications

Video Heads

Four heads - Hi-Fi

Video Signal

EIA standards; NTSC color

Antenna

VHF/UHF – 75 ohm external antenna terminal

VHF Output Signal

Channel 03 or 04 (switchable)
75 ohms unbalanced

Power Requirement

120V AC; 60Hz

Power Consumption

14W

Operating Temperature

41°F (5°C) to 104°F (40°C)

Relative Humidity

10% to 80%

Weight

5.3 lbs. (2.4 kg.)

Dimensions

14-3/16" (W) x 3-5/8" (H) x 8-1/2" (D)
(360mm x 92mm x 215.5mm)

Tuner Broadcast Channels

VHF 2-13, UHF 14-69

Cable TV Channels

1-125

NOTE: Designs and specifications are subject to change without notice.

| | | |
|----------------------------------|--|-----------------------------------|
| ac power cord.....25 | memory button.....20, 36 | stereo |
| accessories52 | menu button.....20, 24 | broadcast |
| alt.ch button.....21 | mute button.....20 | receiving.....40-41 |
| ant(enna) in jack.....6-10, 25 | number buttons20 | recording.....40-41 |
| audio in/out jacks | on-screen status displays.....22 | hookups40 |
|10, 24, 25, 34, 40, 48 | one-touch recording.....29 | stereo TV hookups.....10 |
| automatic | out jack.....6-9, 25 | still picture.....38 |
| playback.....39 | pause button.....24 | stop/▼ button.....21 |
| rewind, eject, off.....39 | pause/still button.....20, 27, 38 | stop/eject button.....24 |
| batteries5 | play/▲ button.....20, 24, 26, 38 | super high speed searching.....38 |
| blue background.....43 | playing.....26 | super long play.....32, 48 |
| cassette compartment.....23 | power | table of contents.....4 |
| cassette-inside light.....23 | button.....20, 24 | tape |
| cbl/dbs button.....5, 19, 21 | cord.....25 | duplication.....34 |
| ch3/ch4 switch.....6-9, 25 | pwr. (power) light.....23 | eject.....20, 24, 39 |
| channel | real-time counter.....36 | speed.....32, 48 |
| adding.....13 | rear panel.....25 | time search button.....21, 37 |
| deleting.....13 | rec/otr button.....20, 27, 29 | time setting.....15 |
| reviewing.....14 | rec(ord) light.....23 | timer |
| selection.....20 | record button.....24, 27, 29 | light.....23 |
| setup.....11-14 | recording | recording |
| ▲/▼ buttons.....21, 24, 39 | basic.....27 | cancelling.....33 |
| clear button.....21, 36 | one channel/ | checking.....33 |
| clock setting.....15 | watching another.....28 | setting.....30-32 |
| connections.....6-10 | prevention.....5 | tracking.....39 |
| contents, table of.....4 | timer.....30-33 | tv |
| controls | remote control | button.....18, 21 |
| remote.....20-21 | buttons.....20-21 | hookups.....6-10 |
| vcr.....23-25 | sensor.....24 | position.....21, 24 |
| copyright protection.....34, 45 | repeat play.....35 | vcr |
| counter only mode.....22 | rerecording.....34 | button.....20 |
| daylight-savings time.....16 | rew(ind)/◀ button.....21, 24, 38 | light.....23 |
| display panel.....23 | rf coaxial cable...6-9, 34, 40, 48, 52 | position.....21, 24 |
| duplication.....34 | safety precautions.....3 | vcr/tv button.....21, 24 |
| eject button.....20 | searching.....38 | video in/out jacks |
| enter button.....18-19, 21 | second audio broadcast |10, 24, 25, 34, 40, 48 |
| f.fwd/▶ button.....21, 24, 38 | receiving.....40-41 | vol(ume)▲/▼ buttons.....20 |
| front panel.....24 | recording.....40-41 | warranty.....46-47 |
| glossary.....48 | sensor (remote).....24 | |
| head cleaner.....3, 5, 45 | slow | |
| helpful hints.....44-45 | button.....20, 38 | |
| hi-fi stereo sound system.....42 | motion.....38 | |
| hookups | slp.....32, 48 | |
| with cable box/dbs.....8-9 | sp.....32, 48 | |
| with stereo tv.....10 | specifications.....48 | |
| without cable box/dbs.....6-7 | speed button.....20 | |
| language selection.....11, 17 | standard play.....32, 48 | |
| line input mode.....12, 34, 48 | status display.....22 | |
| long play.....32, 48 | status/exit button.....21, 22, 24 | |
| lp.....32, 48 | | |

SUPPLIED ACCESSORIES

The following items are supplied with your VCR; they are provided to help you use or set up your VCR.

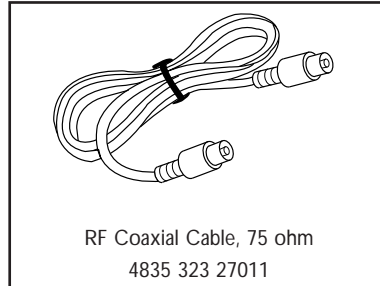
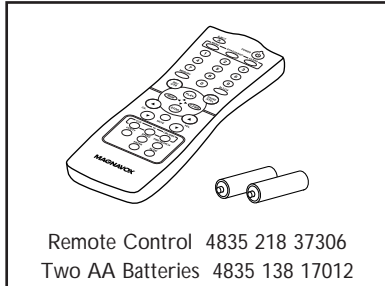

OPTIONAL ACCESSORIES

The following additional items are not provided with your VCR, but they are designed for use with your new VCR. To order these optional accessories, contact us at:

Philips Parts & Accessories Marketing Department
401 East Old Andrew Johnson Highway
P.O. Box 555
Jefferson City, TN 37760
1-800-851-8885.

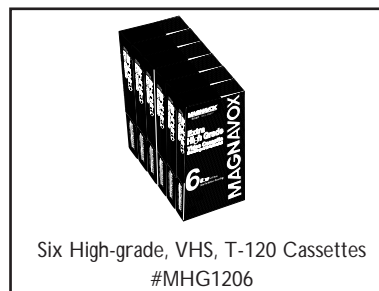
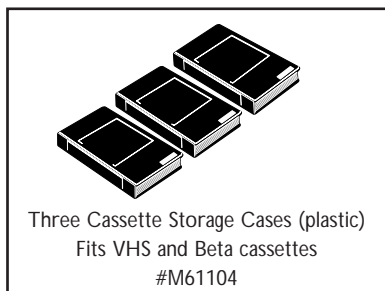
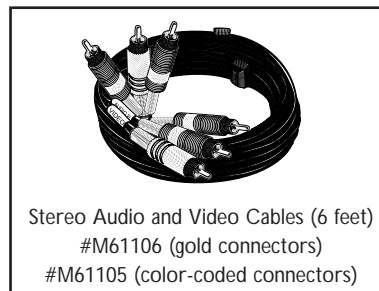

This owner's manual is made of recyclable materials.
Remember to recycle!



As an ENERGY STAR® Partner, Philips Consumer Electronics has determined that this product meets the ENERGY STAR® guidelines for energy efficiency. ENERGY STAR® is a U.S. registered mark.

IB8265E001
Printed In China
OVMN02620 / H79J0UD * * * * *