

Haier

Double Drive Fully Automatic Washing Machine

User's manual

HWM70-928NZZ
HWM80-928NZZ

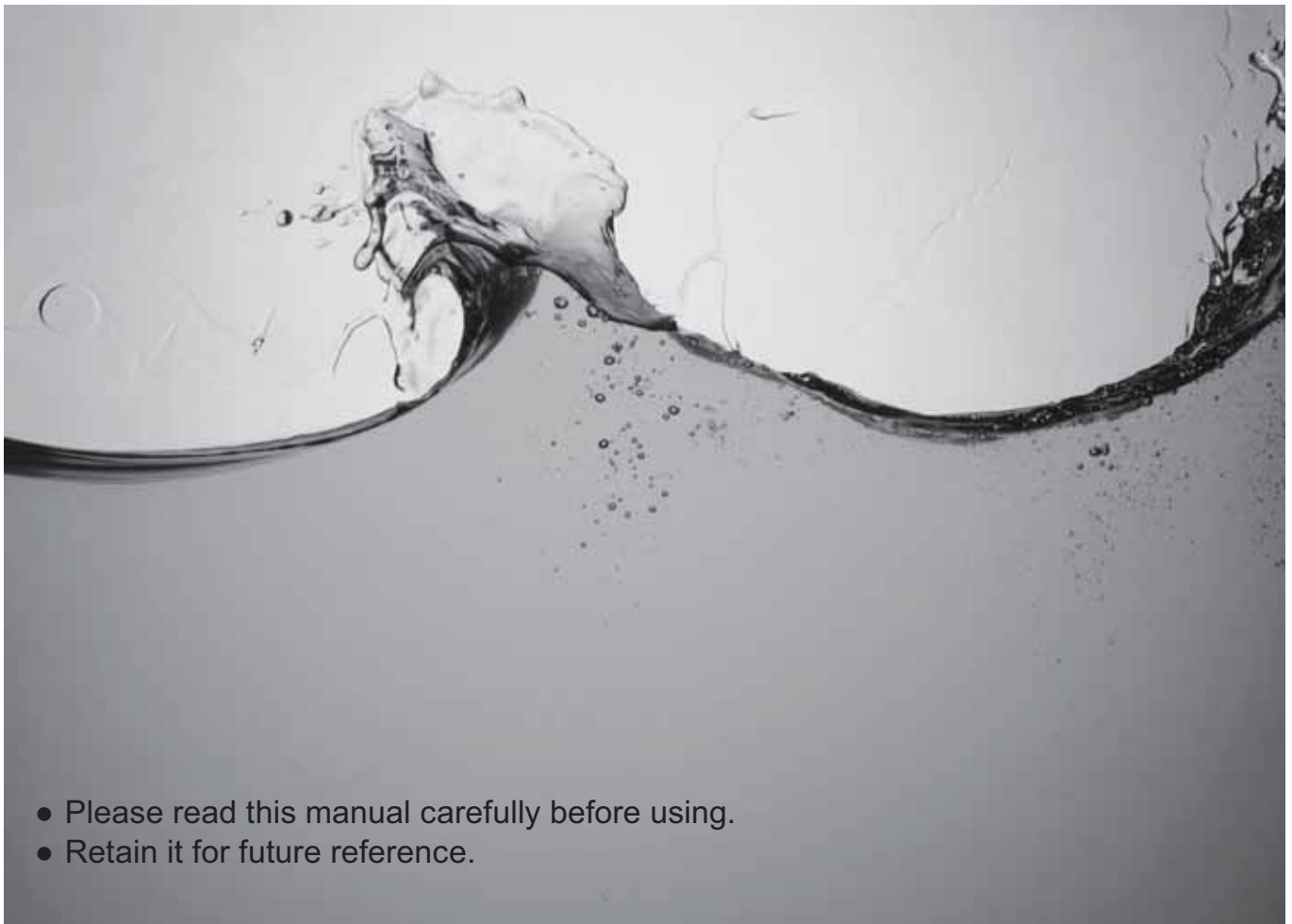

- Please read this manual carefully before using.
- Retain it for future reference.

Contents

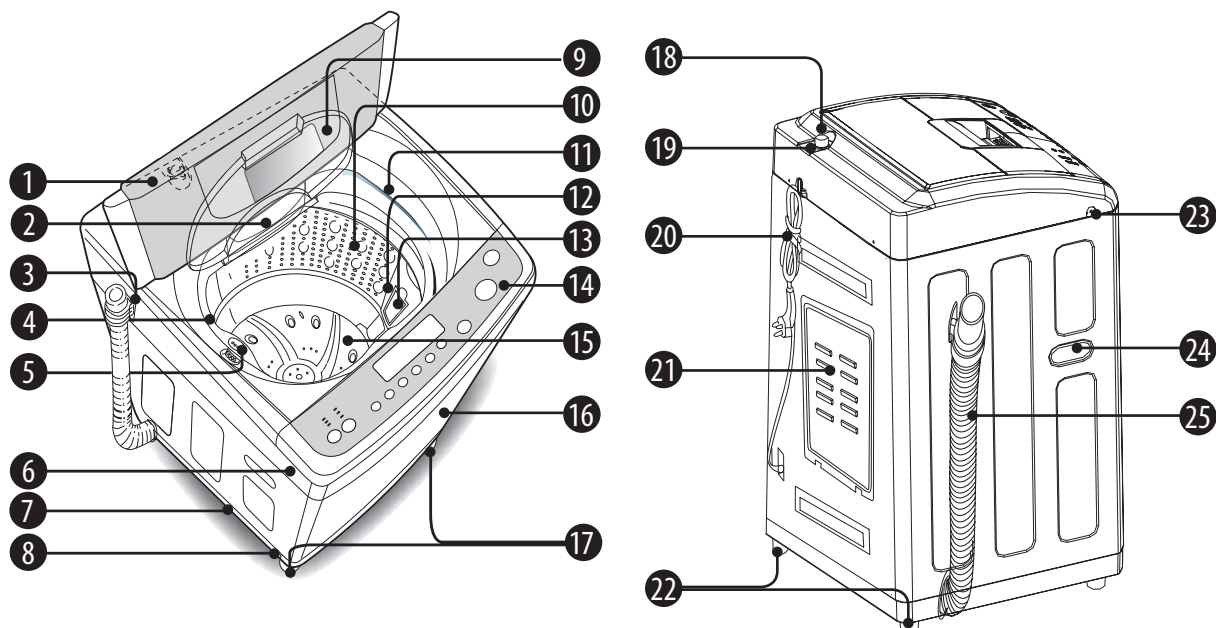

Names of the parts	3
Safety precautions	4
Installation and adjustment	6
Install the water inlet hose	9
Preparation before washing	11
Put in the laundries	12
Use the operation buttons.....	13
Disposal after washing.....	17
Trouble-shooting answer to question	18
Packing List	19
Specifications	19

Names of the parts



- | | | |
|-----------------------------------|------------------------|----------------------------|
| 1 Top lid component | 10 Inner tub | 18 Water inlet valve |
| 2 Detergent box | 11 Outer tub cover | 19 Water absorption gasket |
| 3 Hook | 12 Filter cover | 20 Power cord |
| 4 Balance ring | 13 Lint filter | 21 Back cover |
| 5 Softener inlet | 14 Front control board | 22 Fixed foot |
| 6 Control panel seat | 15 Pulsator | 23 Screw cover |
| 7 Base frame | 16 Cabinet | 24 Cabinet handle |
| 8 Adjustable foot label(2 pieces) | 17 Adjustable foot | 25 Drain hose |
| 9 Inner cover | | |

Meaning and description of the symbols

<p>Warning sign</p> 	<p>Contents marked with that symbol are related to the safety of the product and the personal safety of the users. Please operate in strict conformity to the contents, otherwise it may cause damage of the machine or injure the personal safety of the user.</p>
<p>Forbidden sign</p> 	<p>Contents marked with that symbol are actions forbidden to perform. Performing of those actions may result in damage of the machine or injure the personal safety of the user.</p>

Safety precautions

Please plug the plug on special receptacle with rated voltage. Be sure to use singlephase three pins receptacle. Ensure the earthing prong of the power receptacle is earthed reliably. Use leakage protector if possible.



The power cord plug should be convenient to be plugged in or plugged out with hand while the washing machine runs normally. Be sure to pull the plug out and close the water tap when the machine is idle, when moving the machine, or when cleaning the machine. Do not use wet hand to insert or pull out the power plug.



- Do not bend ,extend, twist, bind by force. Do not press or nip it with weight.
- Keep the pin of the power plug clean, if the power plug is polluted with dust, please wipe with dry cloth carefully.
- If the power cord or the power plug is bad, to avoid risk it is required to have it replaced by the technicians of our special shop or our customer care agent.



In case the washing machine is installed on ground with carpet, do not block the ventilation hole with carpet.

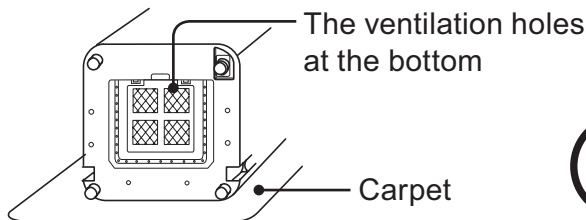

Do not use water hotter than 50 °C .



Do not put the machine at damp place like the bathroom. Never wash it with water. Not put wet laundries on the control panel.

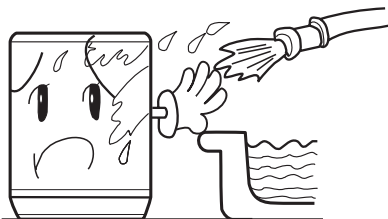

Do not wash water-proof laundries like the raincoat, bike covers etc. to avoid abnormal vibrations in spinning.



Do not let the machine share one receptacle with other electric appliances. If the power plug is damaged, or the plugging into the receptacle is loose, do not use the plug any more.

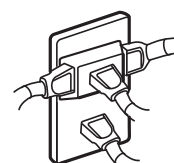

Do not put hand into the rotating tub. It is dangerous even if the rotation speed is slow. Take special care of the children. Keep children away from the washing machine to avoid them climbing on.



Do not decompose, repair or alter the machine by yourself.

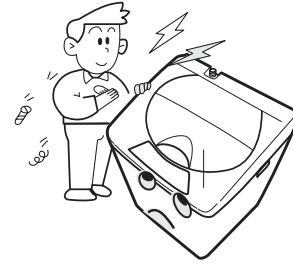

Do not put any hot or heavy items (such as the kettle with hot water) on the washing machine.



Do not wash laundries with volatile materials (such as thinner, petrol etc.)

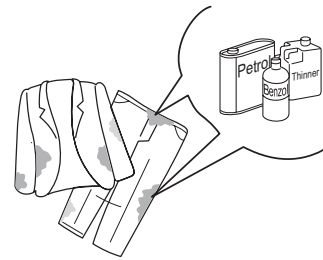

The handicapped or children without care shall not use the machine.

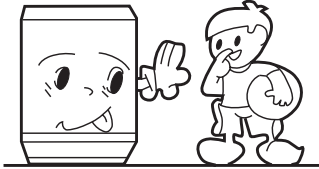

Keep the machine away from direct sunlight and heat source like the heater.

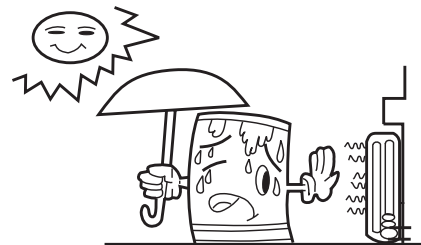

Please keep the lint filter in good condition, and install it to proper position during washing. If the lint filter is lost or damaged, please contact the customer care agent of our company.

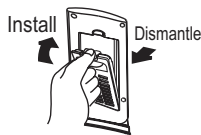

To protect your laundries and washing machine, please take out all of the coins, buttons, sand, hairpin and other foreign materials before washing.

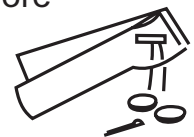

- Please check if the water faucet is open, and if the connection of the water inlet pipe is proper.
- It is suggested to use foamless washing powder.
- To change the direction of drain pipe, please contact the customer care agent of our company.
- Please don't use the washer in the environment below 0°C; if the washer has been stored below 0°C, please be sure to ensure the washer is placed under the room temperature for 2~4 hours and then use otherwise the washing effects may be lowered or the washer may be damaged.

Installation and adjustment

Please install and adjust the machine according to the requirement of the manual. It is very important to your security and correct operating the machine.

Install the inner cover component

1. Open the top lid of the washing machine.
2. Put the inner cover component on the outer tub cover, aiming the inner cover shaft to the installation hole of the corresponding outer tub cover shaft groove.
3. Firstly insert the inner cover shaft of one side into the corresponding outer tub cover shaft groove, then push the another inner cover shaft into the corresponding outer tub cover shaft groove. Please install to designated position to guarantee there are no dropping or abnormal sound in opening and closing of the inner cover, and the operation shall be smooth. Do not dismount the inner cover component after washing.

Figure 1

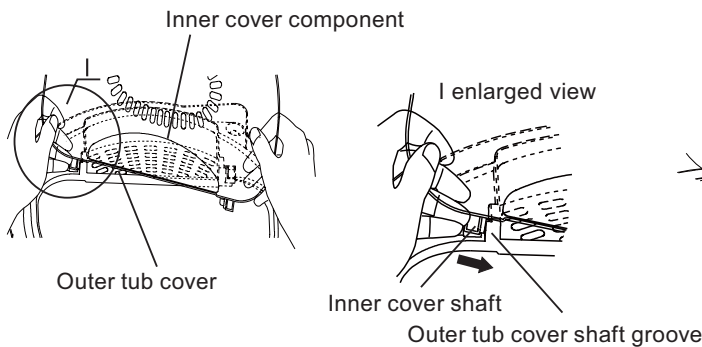
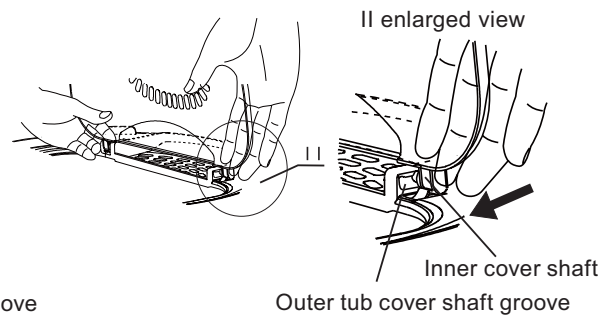

Figure 2



Install the bottom plate

After you open the package, please lean the washing machine gently down on soft items (like the towel cloth, blanket, etc.).

Install the bottom plate to the bottom of the machine with the eight screws by a cross screwdriver, then lift the machine up gently. See to the figure:

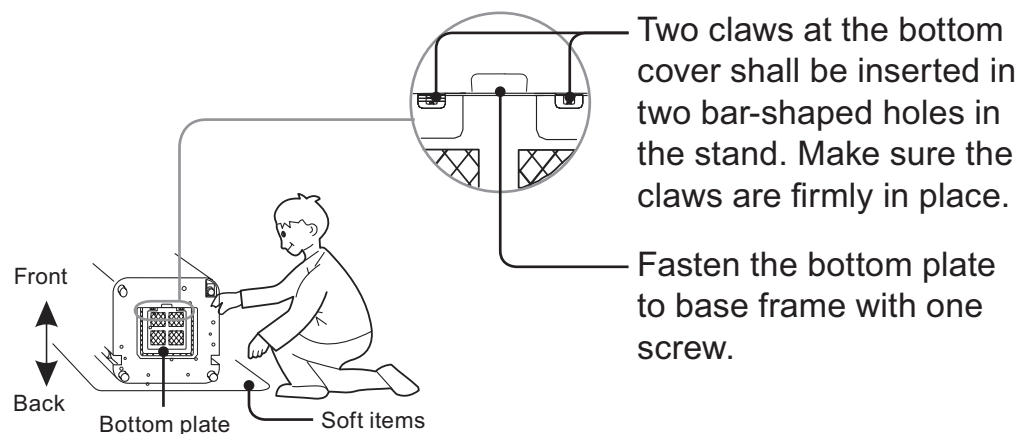

Adjust the installation position

The largest allowed slope of the shank base of the machine is 2°. The slanting or rough ground will result in unstable running or stoppage of the machine. Please adjust it with following methods:

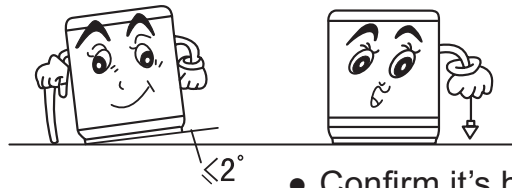

- Confirm it's horizontal: Hang the lead line to check if it is horizontal.

• Adjust the adjustable foot:

To adjust the washing machine, please first lift up the front of the machine slightly, then twist the adjustable foot on the both side.

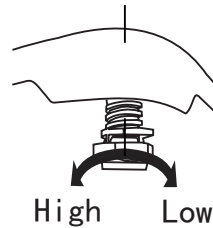

Usage of the drain hose

The drainage shall be smooth with the drain hose.

1. The height of the drain hose shall be less than 10cm, or the drainage will not be smooth, and cost such long time that the machine may stop at mid way.

2. Do not step on or press the drain hose.

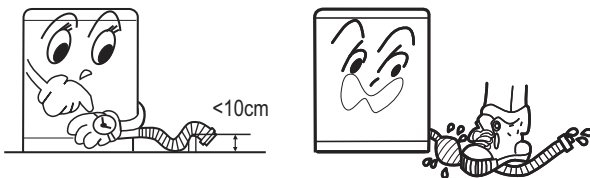

3. If the drain hose is too long, cut it at mid point. To make smooth drainage, cut the front end of the hose slantingly.

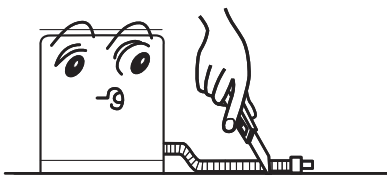

4. If extra drain hose is needed, please make separate purchase. The inner diameter of the extra hose shall not less than 30 mm, and the length shall not exceed 1.5 m.

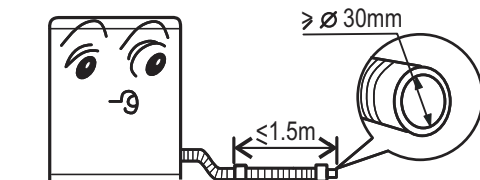

4. If the extra hose is too long, cut it either at A or at B.

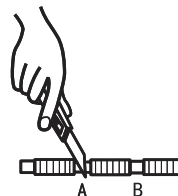

How to change the direction of the drain hose

Remarks: In order to make sure of the correct of installation, it is suggested to change the direction of the drain hose with our company serviceman.

HWM70-928NZP

1. Dismantle the back cover of the washing machine.
2. Press the spring lamination lightly and pull the top segment of the drain hose decumbent then put down the drain hose from the drain hose frame.
3. Put down the drain hose, squeeze the drain hose lightly and take off the hook, put the drain hose into the cabinet. Take off the small baffle which installed on the other drain outlet and install it on the side which won't install the drain hose.
4. Extend the drain hose from the other side and install it on the base by the drain hose frame
5. Install the back cover.

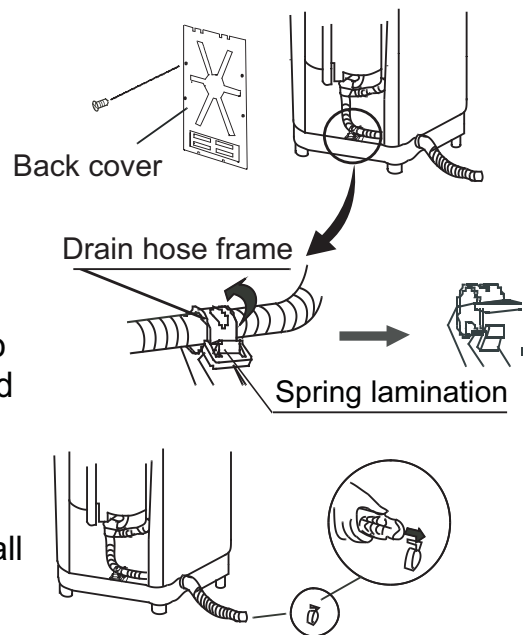

HWM80-928NZP

1. Please lean the washing machine gently down on soft items, such as towel, cloth, blanket, etc. (as indicated in Figure 1)
2. Dismantle the bottom plate. (as indicated in Figure 2)
3. Nip the end of the drain hose and remove the hook of fixing the drain hose. (as indicated in Figure 3)
4. Put your hand into the washing machine and undraw the drain hose clamp. Extend the drain hose in other side and fix it with the clamp. (as indicated in Figure 4)
5. Install the bottom plate and the hook of fixing the drain hose.

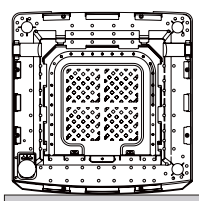

Figure 1

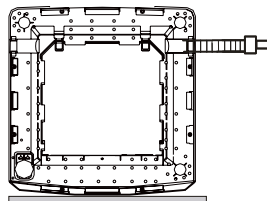

Figure 2

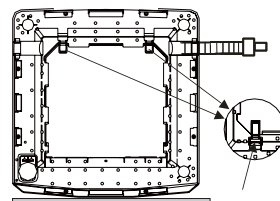

Figure 3

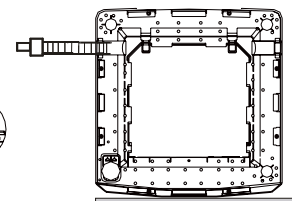
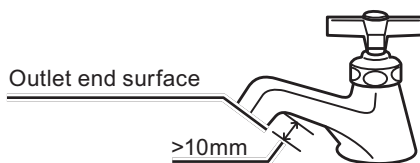

Figure 4

Install the water inlet hose

Confirm the water faucet

Water tap, suitable



Water tap, not suitable

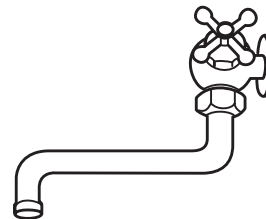

It is required that the front end shall be longer than 10mm.

The outlet end surface of the tap shall be flat and smooth. If not please file it to avoid leakage.

Connection between the water inlet hose jointer and the water faucet

1. Press the lower end of the lock lever and push down the slider. Take off the water inlet hose jointer from the water inlet hose component. See to Figure 1.
2. Loosen the screw till the water faucet can be accessed. Put the jointer of the water inlet hose on the faucet. See to Figure 2.
(If the faucet is too large and the jointer can not be set on the water faucet, please loosen the four screws and take out the bushing in the jointer. The front end of the faucet must be smooth, otherwise it may leak water. See to Figure 3.)

Figure 1

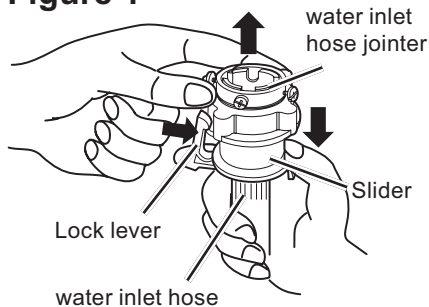

Figure 2

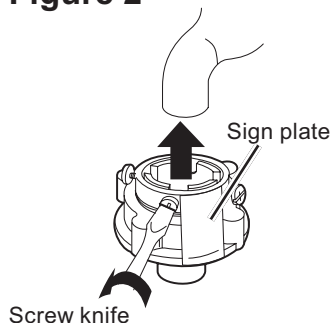
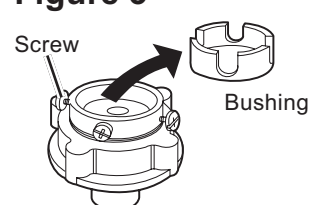

Figure 3



3. Fasten the four screws evenly. See to Figure 4.
4. Take off the nameplate. Twist the fastening nut as per the indication of the figure to seal up the exit end face of the faucet. See to Figure 5.

Remarks: Before installation, the threading is 4mm above the upper surface of the nut.
After installation, the threading is 2mm above the upper surface of the nut.
See to figure 6.

Figure 4

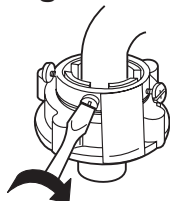

Figure 5

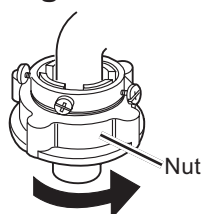
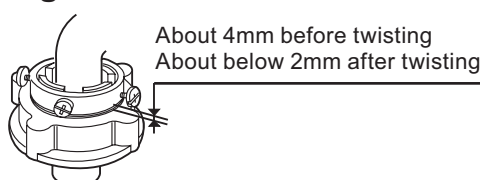
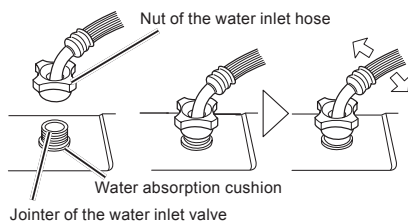

Figure 6



Connection between the water inlet hose and the washing machine

1. Do not take off the water absorption cushion. Please check if the cushion is dropped or damaged before each usage. If it happens please contact our after-sale department immediately.
2. Put the nut of the water inlet hose on the valve jointer.



3. Fasten the nut. Swing it gently to confirm if it's suitable.

The new hose-sets supplied with the appliance are to be used and that old hose-sets should not be reused.

Connection between the jointer of the water inlet hose and the water inlet hose

1. Push down the slider. Insert the water inlet hose into the jointer.
2. Hang the lock lever to the jointer. Release the slider till a click sound is heard.

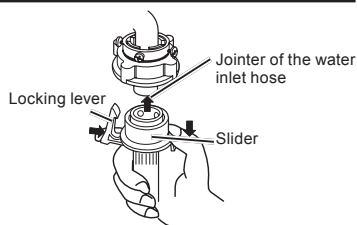

Check the connection between the jointer of the water inlet hose and the water faucet

1. Swing the hose gently to confirm if it is fastened stable.
2. After installation, open the tap to check if it leaks.
3. Do not bend the hose with overstrain.
4. Before each usage please check if the connection between the jointer of the water inlet hose and the water tap, and the installation of the water inlet hose are firm, so as to prevent dripping from improper Installation position.

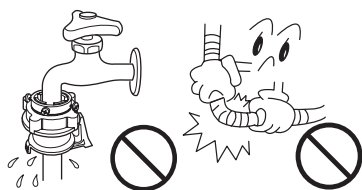

Dismantle the water inlet hose

1. Close the water faucet.
2. Press the locking lever. Push down the slider. Then pull off the water inlet hose. If the machine is used more than once every week, the jointer of the water inlet hose can be kept on the tap to prevent damaging the fixing screw.

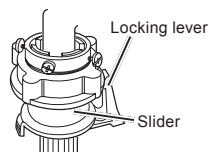

Preparation before washing



Preparation before washing

1. Connect the water inlet hose.
2. Confirm that the washing machine is earthed reliably. Then insert the power plug into the receptacle. Do not connect the earth terminal to the gas pipe and tap water pipe.
3. Put down the drain hose.
4. Slanting or uneven ground may result in unstable working or abnormal noise. Please make the machine stand horizontally.

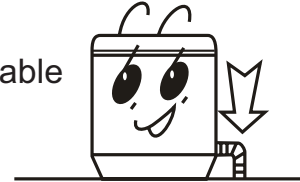

● Pay attention to followings before washing the laundries

Confirm if there's special requirement for the laundries.

Clear the pocket.

Take out the coins, sand, hairpins etc.

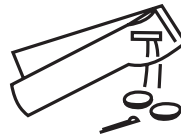

Fasten the buttons and zippers.



The quantity of the laundries shall not exceed the rated value.

The big laundries like the jeans shall be put in loosely.



When the pulsator is running, the buttons of the laundries may cause noise.

For the sake of discretion, please put the laundries with buttons into other laundries.



- a. Please check if the laundries are applicable for washing.
- b. Separate those not colorfast from other laundries.
- c. For laundries not water absorbing, please put them into water with hands.
- d. For laundries with much soil, please remove the soil first. You can add detergent on the part with serious soil directly. It is much easier to remove the soil by that mean.
- e. For laundries likely to get lint ball or with long fiber, please first turn the inside out before putting them into the water.
- f. Do not put the laundries polluted with chemicals directly into the washing machine.
- g. For those small laundries, laundries likely to be twisted or worn, and woolen laundries, please put them into mesh bag before washing.

Put in the laundries



- The capacity of washing and spinning of the machine refer to the largest weight of the standard laundries under dry condition that can be washed or spinned in one time. One time washing quantity shall be lower than the rated capacity.
- The thickness, size, type of the cloth will influence the actual washing capacity. It is suitable for one time washing to put in reasonable amount of laundries and the laundries can be turned round in washing.
- Do not select “35L” (for HWM80-928NZZ) or “26L” (for HWM70-928NZZ) water level for laundries less than 1.0kg, so as to avoid splashing of water.

Usage of the detergent

How to use the washing powder

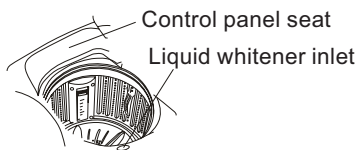

- It is suggested to add washing powder into the box directly under fuzzy program and reserve program.
- Dissolve directly inside the washing machine: (not applicable for fuzzy and reserve program)
 1. Add some water(select “18L” water level for HWM80-928NZZ and “14L” water level for HWM70-928NZZ).
 2. Add washing powder. Run for about 30s to fully dissolve the powder. Then push the “Start/Pause” button.
 3. Put in laundries. Select suitable water level. Push the “Start/Pause” button again.
- Quick dissolving of washing powder:
 1. Prepare warm water of 30°C and container.
 2. Add washing powder while stirring to dissolve it completely.
- Please add suitable washing powder as per the laundries quantity, the set water level and water quantity.
- If you select “Quick” program, it is suggested to use liquid detergent instead of washing powder to guarantee the washing effect.
- It is not recommended to use rich-foam washing powder.
- Washing powder with poor quality or long-time storage may get caked. Please clean the detergent box in time.

How to use the whitener

- Add water to decided level. Dilute the whitener with container, and then pour it into the liquid whitener inlet slowly.
- Laundries with color or pattern is not colorfast, thus not applicable.
- The whitener shall not touch laundries directly.
- See to the manual of whitener for the usage

and dosage.

- For whitener in powder, dissolve it before using.

How to use the softener

HWM70-928NZZ

Figure 1

Access for detergent and washing powder

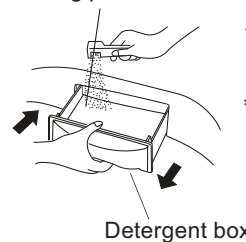
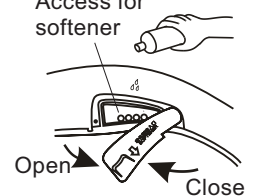

Figure 2



Figure 3

Access for softener



- Turn the inner tub, you will find a softener inlet as the figure 2, open the cover, put the softener into the inlet as the figure 3 before washing, close the cover and the softener will drop into the inner tub during the last time rising. After that, please close the detergent box.

HWM80-928NZZ

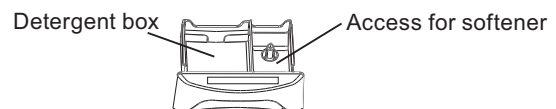

- Before washing put the softener into the box.
- The softener will drop into the inner tub during the last time rising

- The usage and dose of the softener as per the specifications of softener.
- Refer to the list for the usage of the detergent: selection of the water level, water quantity and dosage of detergent.
- After the softener is put in, please don't place for a long time otherwise softener may solidify and cause flowing not smooth.

Remark:

Do not use softener if rinse times is not two.

Use the operation buttons

Description of the function of the buttons (Take example for HWM80-928NZZP)

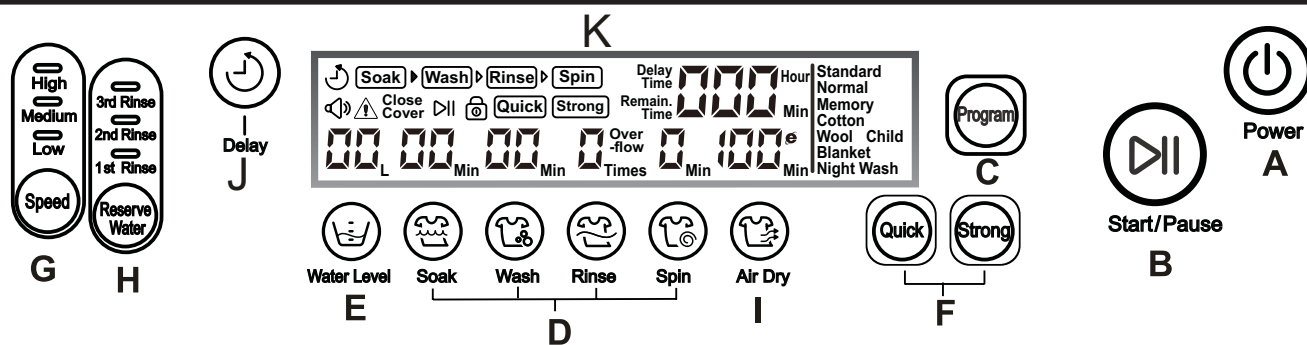

Indicator mode and meaning

- Off
- :O: Flashing: indicate the running program
- On: indicate the program about to run, or indicate the selected mode

Child lock function

- The function is intended for children safety and preventing the washing program from accidental changes by children.
- Set the child lock function : Push and hold the Program button and Strong button, then push down the Power button . After 3 beep sounds, you can continue setting desired washing procedures. After setting ,push down the Start/Pause button. The child lock function is activated, all of the buttons are locked and cannot make selection.
- Release the child lock function : push down Program button and Strong button at the same time for more 3 seconds. After 3 beep sounds ,the child lock function is released.

A “Power” button

- Push the “Power” button to switch on the power.
- Under power-on mode, push it to switch off the power.
- Push the “Power” button to switch on the power. If the “Start/Pause” button is not pushed, the machine will switch off the power automatically after 5 minutes.

B “Start/Pause” button

- After the power is switched on, press it to start the machine.
- During working, push it to pause.
- During pause, push this button to restart and go on working.

C “Program” button

Program	Application	Program	Application
Standard	Standard water saving washing for normal laundries with function of stop against washing clean by default (water level will be set fuzzily)	Normal	Normal washing mode(water level will be set fuzzily and automatically)
Memory	For common program, the washing machine will memory the program selected at last time automatically , no need to set again(water level will be set fuzzily and automatically and can not be memory)	Cotton	For washing of cotton flax clothes with function of stop against washing clean by default
Wool	For soft washing of woollen laundry	Child	Washing the children clothes, the default program contains soak function
Blanket	For soft washing of blanket laundry	Night Wash	For night washing or quiet washing

D “Soak”, “Wash”, “Rinse”, “Spin” button

- Press the “Soak”, “Wash”, “Rinse”, “Spin” button to select the desired soak time, wash time, rinse times and spin time from the Standard, Normal, Memory, Cotton, Child, Night Wash programs.
- Press “Wash”, “Rinse”, “Spin” button can change the process, can not change wash time, rinse times and spin time from the Blanket programs. Press “Soak” button, can not change time and the process from the Blanket programs.
- For Wool program, press “Soak”, “Wash”, “Rinse”, “Spin” button, can not change times and the process.
- During rinsing times setting, it could be selected whether overflow rinsing is required or not according to actual demand. If overflow rinsing is set, water is continued to fill into the washing machine after setting level is reached, until it is overflow, then foam in barrel will spill out of spillway port, so as to prevent foam and dirt floating on surface pollute laundry again (note: if low level or pressure is selected, and it may not reach overflow level, then overflow rinsing will transfer to storage rinsing.)

E “Water Level” button

- During Standard or Memory program with washing process. The washing machine can detect the laundries automatically. After detection, it will set the water level to suitable value among 35L, 45L, 53L, 61L, 70L (26L, 33L, 39L, 45L, 51L for HWM70-928NZZ) automatically.
- Water level could also be determined by user, but it couldn't automatically again after this machine started. You shall push the “Start/Pause” button to make new setting.
- If there's water inside the tub, the machine cannot detect the laundries and will display water level 45L (33L for HWM70-928NZZ). If wet laundries are put in, it may display water level 70L (51L for HWM70-928NZZ). You must set suitable water level by yourself.
- During operation of Wash and Rinse programs, you can push down the Water Level button to add water. When you release the button, or it reaches the overflow water level, the machine will stop adding water.
- The water level decided may be different from actual value because of the different moisture level of the laundries.
- The rinse water value will be one level higher than the wash water value. (Except the highest water level and when the rinse water level is selected by yourself).
- Under the wool and Blanket program, only the 45L to 70L water level (33L to 51L for HWM 70-928NZZ) can be selected.

F “Quick”, “Strong” button

- For Standard, Normal, Memory, Cotton, Wool, Child, Blanket, Night Wash program, press “Strong” button, can increase washing time from originally time (arrive at 25 minutes at most), can increase rinse times (3 times at most); press “Quick” button, can reduce washing time from originally time (at least 8 minutes), and rinse times become once.
- Press “Quick” button over 5sec. it could enter standard test program after standard indicator become flash.

G “Speed” button

- Press “Speed” button can adjust Wash, Rinse, Spin speed.
- For Standard, Normal, Memory, Cotton, Child, Night Wash program, press “Speed” button once, can set differ speed: Low, Medium, High. (differ water level default differ speed: the first 4 low water level default low speed, the middle 4 water level default medium speed, the last 4 high water level default high speed)
- For Wool, Blanket program, press “Speed” button, can not adjust speed, default low speed.

H “Reserve Water” button

- Press “Reserve Water” button to keep rinsing water;
- When Reserve Water mode is selected, the washing machine will keep rinsing water after each rinsing with buzz and voice indications (for example, if 2nd rinsing is selected, then 2nd rinsing water will be kept; if 1st rinsing and 2nd rinsing) are selected at the same time, then 1st and 2nd rinsing water will be both kept). During waiting minutes, drainage function could be activated if open and close cover once or press start/pause key, buzz will prompt every 15 minutes within 4 hours, if no operation within 4 hours during waiting, it will drain water directly after one buzz, and then turn to next process.

I “Air Dry” button

- Press “Air Dry” button to set drying time (in minute), including 30,60,90,120 and 180 min in turn;
- It is suggested that dry time below 60 min is suitable to internal and external barrel, so as to prevent mildew.
- This product could dry 1.5kg synthetic clothes in once at most (clothes suits to iron after dry). Dry degree will be varied with different clothing. Clothes shall be losing before dry.
- The dry mode couldn't be selected for program of “Night Washing”, “Wool”, or “blanket”.

J “DELAY” button

- Press the button to select the reserve time (2h-24h).
- Press the button can display the reserve state.

K LCD screen

- It displays program detected.
- It displays remained reserve time (hour).
- It displays abnormal symbol in abnormal situation.

Steps of using the operation buttons and description of each step

1. Push “Power” button to switch on the power

It has the special power resume function. In the case of power failure or the power plug is loose during running, the machine can save the running program, and resume the program after the power supply is recovered. You do not need to set the program again.

2. Push “Program” button to select suitable full-auto program

- After the power is switched on, “Standard” is automatically set. To select other full-auto programs, please push the “Program” button till the corresponding indicator is on. Refer to the “Program” button on Page 13.
- When a standard cycle is selected, the fuzzy program is run. The water level and the washing time can be selected according to be texture and volume of the laundry. The washing cycle is automatically controlled.

- Before washing, please fold up the laundry as needed, then put the laundry into the inner tub, flat and neat.
- These fabrics are not washable:
 1. Fabrics that deform when soaked in water;
 2. Fabrics that shrink, discolor or go through other exterior changes when soaked in water;
 3. Fabrics that lose original texture when soaked in water;
 4. Fabrics that discolor when soaked in water;
 5. Fabrics that have pilling or pressed pile when soaked in water;
 6. Fabrics that is damageable when soaked in water.

- Upon completion of washing, iron the laundry with a steam iron.
Hold the steam iron above the laundry and do not touch the laundry. Reshape the laundry.

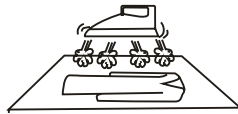

Figure 1

When shrinkage occurs Stretch the laundry to its original size and locate it with pins. Use a steam iron to dry the laundry completely. Do not touch the laundry.

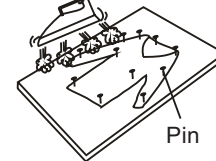

Figure 2

3 Push “Soak” “Wash” “Rinse” “Spin” button to select suitable procedure program

- Even there’s no water in the tub, a certain period is required before spin starting.
- Separate the laundries that are not colorfast from other laundries in washing.
- After the machine starts operation, you can only set the program and procedure during washing and soaking,
- During rinsing ,you can only set the spinning time, and can not make setting in other cases.

4 Push the “Water Level” button, select suitable water level

For Standard program, the washing machine will execute fuzzy program automatically to detect the cloth. After defection, it can set the water level automatically.To select other water level, first push the “Start/Pause” button, then push the “Water Level” button to set the water level.

5 Push the “Delay” button to select suitable reserve wash program

- After switching on the power, the reserve program is set to off mode automatically. If you need to set the washing procedure to be finished at reserved time, please push the Delay button to set the reserve wash program. Refer to reserve button in Page 15 for selection.
- When the Delay function is activated, the indicator light of the program you have set will be off. The digitron will display remaining delay time(hour). During reserve procedure, push the “Delay” button to display the reserve mode.
- To change the running program or cancel the reserve setting, you need to switch off the power and make new selection.

6 Push the “Start/Pause” button

Close the top lid

As the top lid opened, the washer will automatically alarm and stop running, exclusively during draining and water filling.

Finish washing

After finishing washing ,it’ll alarm and switch off power automatically.

Disposal after washing

- After using, please clean the lint and foreign materials of the lint filter etc. in time. Otherwise it may influence your using the machine.
- Please first pull off the power plug from the receptacle before cleaning.

Clean the detergent box and set it on the control panel seat.

1. The method of dismantle: Push it up aslant and gently.
2. The method of install : install it upwards and aslant and push it in .

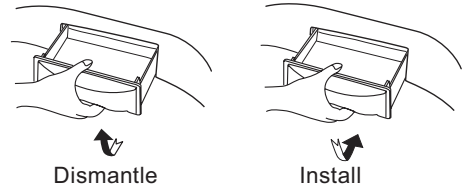

- The lint filter must be used during washing.
- It must be cleaned in time after each using.

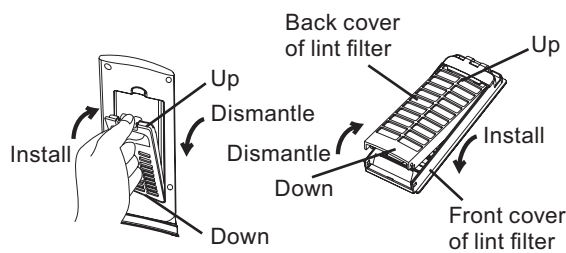

Figure 1

Figure 2

Lint filter:

1. Push down the spring piece of the top lint filter to make the claws out of the filter cover, and then pull out the lint filter to get it down. (figure1)
2. Pull the back of the lint filter, and then you can get down it off the front cover of the lint filter. (figure2)
3. Sweep the rubbish in the lint filter.
4. Put the back of the lint filter into the front cover.
5. Put the lint filter into filter cover, and make it tight.
6. Make sure the lint filter well installed, or it can influence your use.

The filter screen of the water inlet valve is likely to be blocked by foreign materials and influence the water inlet. Please clean it with brush every two months.

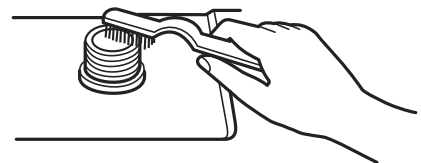

If the cabinet is dirty, wipe it with wet cloth

- Do not flush it directly with water.
- Wipe it with neutral detergent.
- Do not wipe it with thinner, petrol, alcohol etc.



1. After washing, close the water faucet. (If needed, you can dismantle the water inlet hose).
2. Do not store water in the washing machine for a long period. Drain the water completely after each using.
3. Be sure to pull off the power plug before maintenance.
4. Hang up the power cord and drain hose.
5. Wipe off the water drops on the surface of the machine and inside the tub. Open the top lid for some time (about 1 hour), then close the top lid.

Trouble-shooting answer to question

(If there's breakdown, please pull off the power plug before checking) The following phenomena are not breakdowns sometimes. Please confirm again before sending it to repair. If there are real breakdowns, please come to the special maintenance department or after-sale service department of our company. Do not repair it by yourself.

Phenomena		The reason	How to settle
The digitron displays E0.		<ul style="list-style-type: none"> The top lid is opened during reserve procedure. 	<ul style="list-style-type: none"> Close the top lid.
The drainage cannot work, or is too slow. The digitron displays E1.		<ul style="list-style-type: none"> Is the drain hose put down? Is the drain hose blocked? 	<ul style="list-style-type: none"> Put down the drain hose. Open and close the top lid once. Clean the foreign material. Open and close the top Lid Once.
It stops running in midway. The digitron displays E2.		<ul style="list-style-type: none"> The top lid is not closed. 	<ul style="list-style-type: none"> Close the top lid.
The safety switch acts, and the spinning cannot work. The digitron displays E3.		<ul style="list-style-type: none"> Are the laundries put slantingly? Is the machine slanting? 	<ul style="list-style-type: none"> Reorder the laundries. Close the top lid. The machine will start running after 10 seconds of being placed horizontally.
The water filling does not work, the digital displays E4.		<ul style="list-style-type: none"> Is the water tap opened, or is there water supply failure? Is the water inlet valve blocked? Is the water pressure too low? 	<ul style="list-style-type: none"> Open the water tap. Open and close the top lid once. Clean the water inlet valve. Open and close the top lid once. Use after the water pressure is normal.
The digitron displays E6.		<ul style="list-style-type: none"> The water level sensor is bad. 	<ul style="list-style-type: none"> Please contact the after-sales service department.
The machine does not act	Not wash	<ul style="list-style-type: none"> Is there power failure? Is the power plug inserted tightly? Is the water level reached preset position? 	<ul style="list-style-type: none"> Please use it when there's power supply. Insert the power plug tightly. Fill water to the preset position.
	Not spin	<ul style="list-style-type: none"> Is the power plug inserted tightly? Is the top lid closed reliably? Are the laundries set flat? 	<ul style="list-style-type: none"> Insert the power plug tightly. Close the top lid. Set the laundries flat.
The water faucet leaks		<ul style="list-style-type: none"> Is the jointer screw of the water inlet hose is loose or twisted awry? 	<ul style="list-style-type: none"> Fasten the jointer screw properly.
There's abnormal sound inside the machine		<ul style="list-style-type: none"> Is the machine slanting? Are the laundries put slantingly in spinning? Are there any foreign materials? 	<ul style="list-style-type: none"> Adjust the machine to be even Reorder the laundries and close the top lid. Remove the foreign materials.
The water tap leaks		<ul style="list-style-type: none"> Is the screw of the jointer of water inlet hose loose or awry? 	<ul style="list-style-type: none"> Fasten the screw of the jointer properly.

Common phenomena

Phenomena	Explanation
<ul style="list-style-type: none"> The spinning is intermittent when it starts 	<ul style="list-style-type: none"> Balance the laundries to avoid slanting.
<ul style="list-style-type: none"> The wash procedure is paused. 	<ul style="list-style-type: none"> The cloth sensor is checking the cloth, it will add water after 48 seconds.
<ul style="list-style-type: none"> Push the SPIN button to select SPIN, but it doesn't work. 	<ul style="list-style-type: none"> The program is setting the drain time. Some time is needed before it starts spinning.
<ul style="list-style-type: none"> The pulsator pauses during water inlet in wash and rinse. 	<ul style="list-style-type: none"> It is to avoid splashing during water inlet.
<ul style="list-style-type: none"> There may be some water flowing out of the drain hose in the first use of the machine. 	<ul style="list-style-type: none"> It is the water remained in the factory inspection of performance.

Packing list

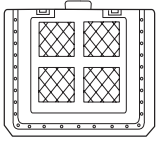
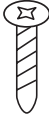
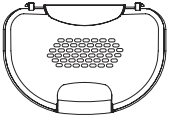
Name	Quantity	Storage position
User's manual	One	Inside the document bag
Components of the water inlet hose 	One	Inside the accessory bag
Bottom plate 	One	Between the upper cushion of the washing machine package and the upper seal of the package carton
Tapping screw 	One	Inside the accessory bag
Inner cover component 	One	
Double Drive Fully Automatic Washing Machine	One	Inside the accessory bag
Warranty card	One	

Specifications

Model No.	HWM70-928NZZ	HWM80-928NZZ
Water level	14L, 18L, 22L, 26L, 30L, 33L, 36L, 39L, 42L, 45L, 48L, 51L	18L, 24L, 30L, 35L, 40L, 45L, 49L, 53L, 57L, 61L, 65L, 70L
Water Injection pressure	0.001MPa - 1.0MPa	0.001MPa - 1.0MPa
Washing / spinning capacity	7.0kg/7.0kg	8.0kg/8.0kg

