

GA-8I845GVM775

Intel® Pentium® 4 LGA775 Processor Motherboard

User's Manual

Rev. 1001

12ME-I845GVM7-1001

Declaration of Conformity

EN 60950-1 and EN 60950-2

EN 60950-1 and EN 60950-2

Manufacturer: **Avaya, Inc.**

Model Number: **GA-81845GVN775**

Product Name: **Motherboard**

Address: **17358 Railroad Street**

City of Industry, CA 91748

Phone/Fax: **818-854-9338 / 818-854-9339**

Reference to the applicable EMC Directive is declared in accordance with 2002/95/EC (RoHS)

Reference to the applicable EMC Directive is declared in accordance with 2002/95/EC (RoHS)

Reference to the applicable EMC Directive is declared in accordance with 2002/95/EC (RoHS)

Reference to the applicable EMC Directive is declared in accordance with 2002/95/EC (RoHS)

Reference to the applicable EMC Directive is declared in accordance with 2002/95/EC (RoHS)

Reference to the applicable EMC Directive is declared in accordance with 2002/95/EC (RoHS)

Reference to the applicable EMC Directive is declared in accordance with 2002/95/EC (RoHS)

Reference to the applicable EMC Directive is declared in accordance with 2002/95/EC (RoHS)

Reference to the applicable EMC Directive is declared in accordance with 2002/95/EC (RoHS)

Reference to the applicable EMC Directive is declared in accordance with 2002/95/EC (RoHS)

Reference to the applicable EMC Directive is declared in accordance with 2002/95/EC (RoHS)

Reference to the applicable EMC Directive is declared in accordance with 2002/95/EC (RoHS)

Reference to the applicable EMC Directive is declared in accordance with 2002/95/EC (RoHS)

Reference to the applicable EMC Directive is declared in accordance with 2002/95/EC (RoHS)

Reference to the applicable EMC Directive is declared in accordance with 2002/95/EC (RoHS)

Reference to the applicable EMC Directive is declared in accordance with 2002/95/EC (RoHS)

Reference to the applicable EMC Directive is declared in accordance with 2002/95/EC (RoHS)

Reference to the applicable EMC Directive is declared in accordance with 2002/95/EC (RoHS)

Reference to the applicable EMC Directive is declared in accordance with 2002/95/EC (RoHS)

Reference to the applicable EMC Directive is declared in accordance with 2002/95/EC (RoHS)

Reference to the applicable EMC Directive is declared in accordance with 2002/95/EC (RoHS)

Reference to the applicable EMC Directive is declared in accordance with 2002/95/EC (RoHS)

Reference to the applicable EMC Directive is declared in accordance with 2002/95/EC (RoHS)

Reference to the applicable EMC Directive is declared in accordance with 2002/95/EC (RoHS)

Reference to the applicable EMC Directive is declared in accordance with 2002/95/EC (RoHS)

Reference to the applicable EMC Directive is declared in accordance with 2002/95/EC (RoHS)

Reference to the applicable EMC Directive is declared in accordance with 2002/95/EC (RoHS)

Reference to the applicable EMC Directive is declared in accordance with 2002/95/EC (RoHS)

Reference to the applicable EMC Directive is declared in accordance with 2002/95/EC (RoHS)

Reference to the applicable EMC Directive is declared in accordance with 2002/95/EC (RoHS)

Reference to the applicable EMC Directive is declared in accordance with 2002/95/EC (RoHS)

Reference to the applicable EMC Directive is declared in accordance with 2002/95/EC (RoHS)

Reference to the applicable EMC Directive is declared in accordance with 2002/95/EC (RoHS)

Reference to the applicable EMC Directive is declared in accordance with 2002/95/EC (RoHS)

Reference to the applicable EMC Directive is declared in accordance with 2002/95/EC (RoHS)

Reference to the applicable EMC Directive is declared in accordance with 2002/95/EC (RoHS)

Reference to the applicable EMC Directive is declared in accordance with 2002/95/EC (RoHS)

Reference to the applicable EMC Directive is declared in accordance with 2002/95/EC (RoHS)

Reference to the applicable EMC Directive is declared in accordance with 2002/95/EC (RoHS)

Reference to the applicable EMC Directive is declared in accordance with 2002/95/EC (RoHS)

Reference to the applicable EMC Directive is declared in accordance with 2002/95/EC (RoHS)

Reference to the applicable EMC Directive is declared in accordance with 2002/95/EC (RoHS)

Reference to the applicable EMC Directive is declared in accordance with 2002/95/EC (RoHS)

Reference to the applicable EMC Directive is declared in accordance with 2002/95/EC (RoHS)

Reference to the applicable EMC Directive is declared in accordance with 2002/95/EC (RoHS)

Reference to the applicable EMC Directive is declared in accordance with 2002/95/EC (RoHS)

Reference to the applicable EMC Directive is declared in accordance with 2002/95/EC (RoHS)

Reference to the applicable EMC Directive is declared in accordance with 2002/95/EC (RoHS)

Reference to the applicable EMC Directive is declared in accordance with 2002/95/EC (RoHS)

Reference to the applicable EMC Directive is declared in accordance with 2002/95/EC (RoHS)

Reference to the applicable EMC Directive is declared in accordance with 2002/95/EC (RoHS)

Reference to the applicable EMC Directive is declared in accordance with 2002/95/EC (RoHS)

Reference to the applicable EMC Directive is declared in accordance with 2002/95/EC (RoHS)

Reference to the applicable EMC Directive is declared in accordance with 2002/95/EC (RoHS)

Reference to the applicable EMC Directive is declared in accordance with 2002/95/EC (RoHS)

Reference to the applicable EMC Directive is declared in accordance with 2002/95/EC (RoHS)

Reference to the applicable EMC Directive is declared in accordance with 2002/95/EC (RoHS)

Reference to the applicable EMC Directive is declared in accordance with 2002/95/EC (RoHS)

Reference to the applicable EMC Directive is declared in accordance with 2002/95/EC (RoHS)

Reference to the applicable EMC Directive is declared in accordance with 2002/95/EC (RoHS)

Reference to the applicable EMC Directive is declared in accordance with 2002/95/EC (RoHS)

Reference to the applicable EMC Directive is declared in accordance with 2002/95/EC (RoHS)

Reference to the applicable EMC Directive is declared in accordance with 2002/95/EC (RoHS)

Reference to the applicable EMC Directive is declared in accordance with 2002/95/EC (RoHS)

Reference to the applicable EMC Directive is declared in accordance with 2002/95/EC (RoHS)

Reference to the applicable EMC Directive is declared in accordance with 2002/95/EC (RoHS)

Reference to the applicable EMC Directive is declared in accordance with 2002/95/EC (RoHS)

Reference to the applicable EMC Directive is declared in accordance with 2002/95/EC (RoHS)

Reference to the applicable EMC Directive is declared in accordance with 2002/95/EC (RoHS)

Reference to the applicable EMC Directive is declared in accordance with 2002/95/EC (RoHS)

Reference to the applicable EMC Directive is declared in accordance with 2002/95/EC (RoHS)

Reference to the applicable EMC Directive is declared in accordance with 2002/95/EC (RoHS)

Reference to the applicable EMC Directive is declared in accordance with 2002/95/EC (RoHS)

Reference to the applicable EMC Directive is declared in accordance with 2002/95/EC (RoHS)



EMC conformity marking

The manufacturer also declares the conformity of above mentioned product with the EMC Directive 2002/95/EC (RoHS)

EMC 60950-1

EMC 60950-2

EMC 60950-3

EMC 60950-4

EMC 60950-5

EMC 60950-6

EMC 60950-7

EMC 60950-8

EMC 60950-9

EMC 60950-10

EMC 60950-11

EMC 60950-12

EMC 60950-13

EMC 60950-14

EMC 60950-15

EMC 60950-16

EMC 60950-17

EMC 60950-18

EMC 60950-19

EMC 60950-20

EMC 60950-21

EMC 60950-22

EMC 60950-23

EMC 60950-24

EMC 60950-25

EMC 60950-26

EMC 60950-27

EMC 60950-28

EMC 60950-29

EMC 60950-30

EMC 60950-31

EMC 60950-32

EMC 60950-33

EMC 60950-34

EMC 60950-35

EMC 60950-36

EMC 60950-37

DECLARATION OF CONFORMITY

Per FCC Part 2, Section 2.1077(a)



Responsible Party Name: G.B.T. INC. (U.S.A.)

Address: 17358 Railroad Street

City of Industry, CA 91748

Phone/Fax: 818-854-9338 / 818-854-9339

hereby declares that the product

Product Name: Motherboard

Model Number: GA-81845GVN775

Conforms to the following specifications:

FCC Part 15, Subpart B, Section 15.107(a) and Section 15.109 (a), Class B Digital Device

Supplementary Information:

This device complies with part 15 of the FCC Rules. Operation is subject to the following two conditions: (1) This device may not cause harmful and (2) this device must accept any interference received, including that may cause undesired operation.

Representative Person's Name: **ERIC LIU**

Signature: *ERIC LIU*

Date: **Feb. 14, 2005**

Copyright

© 2005 GIGA-BYTE TECHNOLOGY CO., LTD. All rights reserved.

The trademarks mentioned in the manual are legally registered to their respective companies.

Notice

The written content provided with this product is the property of Gigabyte.

No part of this manual may be reproduced, copied, translated, or transmitted in any form or by any means without Gigabyte's prior written permission. Specifications and features are subject to change without prior notice.

Product Manual Classification

In order to assist in the use of this product, Gigabyte has categorized the user manual in the following:

- For detailed product information and specifications, please carefully read the "Product User Manual".
- For detailed information related to Gigabyte's unique features, please go to "Technology Guide" section on Gigabyte's website to read or download the information you need.

For more product details, please click onto Gigabyte's website at www.gigabyte.com.tw

Table of Content

GA-81845GVM775 Motherboard Layout	6
Block Diagram	7
Chapter 1 Hardware Installation	9
1-1 Considerations Prior to Installation	9
1-2 Feature Summary	10
1-3 Installation of the CPU and Heatsink	11
1-3-1 Installation of the CPU	11
1-3-2 Installation of the Heatsink	12
1-4 Installation of Memory	13
1-5 Install expansion cards	14
1-6 I/O Back Panel Introduction	15
1-7 Connectors Introduction	16
Chapter 2 BIOS Setup	25
The Main Menu (For example: BIOS Ver. : E2)	26
2-1 Standard CMOS Features	28
2-2 Advanced BIOS Features	30
2-3 Integrated Peripherals	32
2-4 Power Management Setup	34
2-5 PnP/PCI Configurations	36
2-6 PC Health Status	37
2-7 Frequency/Voltage Control	38
2-8 Load Fail-Safe Defaults	40
2-9 Load Optimized Defaults	40
2-10 Set Supervisor/User Password	41
2-11 Save & Exit Setup	42
2-12 Exit Without Saving	42

Chapter 3 Install Drivers	43
3-1 Install Chipset Drivers	43
3-2 Software Application	45
3-3 Software Information	46
3-4 Hardware Information	46
Chapter 4 Appendix	47
4-1 Unique Software Utilities	47
4-1-1 EasyTune 4 Installation.....	47
4-1-2 Xpress Recovery Introduction	48
4-1-3 Flash BIOS Method Introduction	51
4-1-4 2- / 4- / 6- Channel Audio Function Introduction	60
4-1-5 Jack-Sensing Introduction	66
4-2 Troubleshooting	68

GA-8I845GVM775 Motherboard Layout

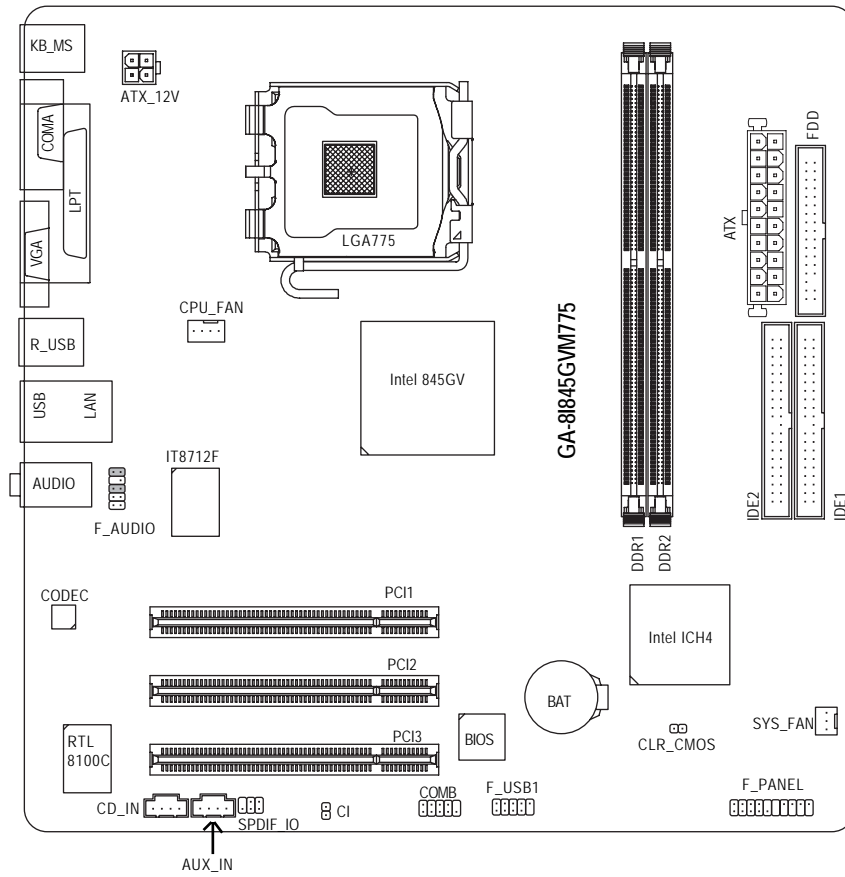

Block Diagram

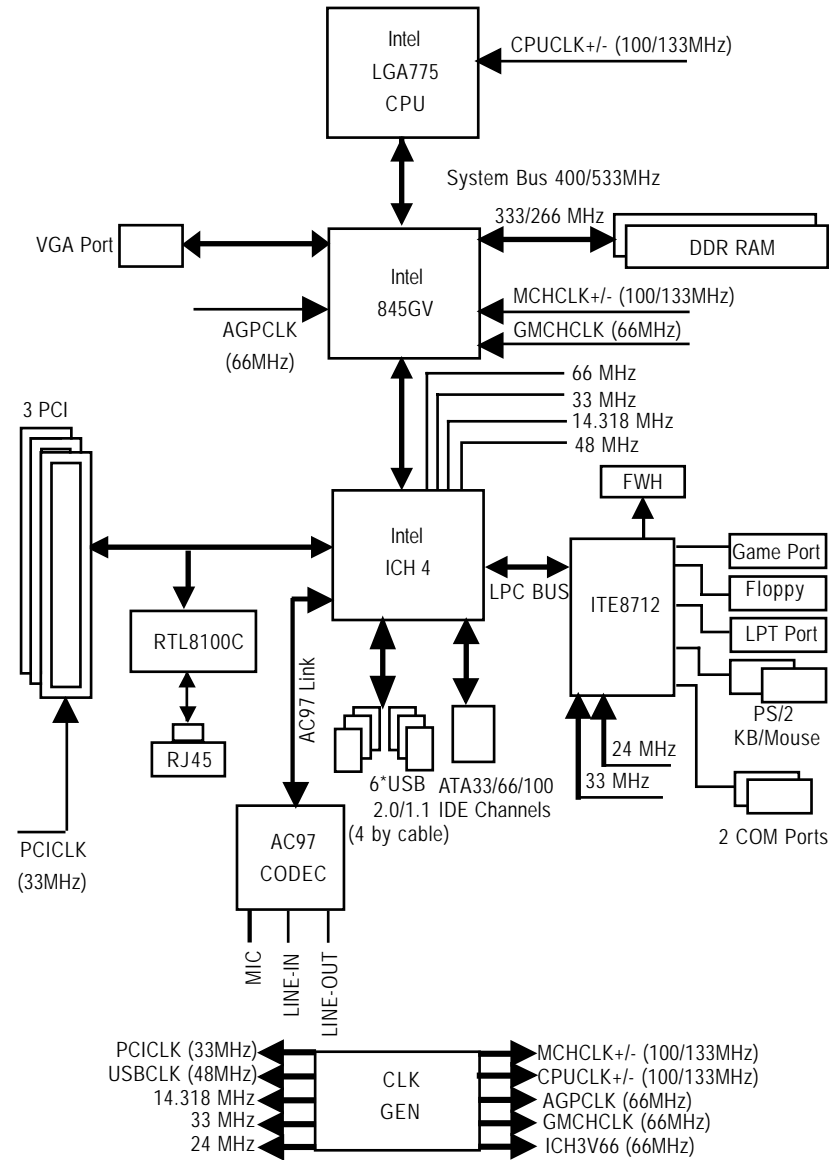

Chapter 1 Hardware Installation

1-1 Considerations Prior to Installation

Preparing Your Computer

The motherboard contains numerous delicate electronic circuits and components which can become damaged as a result of electrostatic discharge (ESD). Thus, prior to installation, please follow the instructions below:

1. Please turn off the computer and unplug its power cord.
2. When handling the motherboard, avoid touching any metal leads or connectors.
3. It is best to wear an electrostatic discharge (ESD) cuff when handling electronic components (CPU, RAM).
4. Prior to installing the electronic components, please have these items on top of an antistatic pad or within a electrostatic shielding container.
5. Please verify that you the power supply is switched off before unplugging the power supply connector from the motherboard.

Installation Notices

1. Prior to installation, please do not remove the stickers on the motherboard. These stickers are required for warranty validation.
2. Prior to the installation of the motherboard or any hardware, please first carefully read the information in the provided manual.
3. Before using the product, please verify that all cables and power connectors are connected.
4. To prevent damage to the motherboard, please do not allow screws to come in contact with the motherboard circuit or its components.
5. Please make sure there are no leftover screws or metal components placed on the motherboard or within the computer casing.
6. Please do not place the computer system on an uneven surface.
7. Turning on the computer power during the installation process can lead to damage to system components as well as physical harm to the user.
8. If you are uncertain about any installation steps or have a problem related to the use of the product, please consult a certified computer technician.

Instances of Non-Warranty

1. Damage due to natural disaster, accident or human cause.
2. Damage as a result of violating the conditions recommended in the user manual.
3. Damage due to improper installation.
4. Damage due to use of uncertified components.
5. Damage due to use exceeding the permitted parameters.
6. Product determined to be an unofficial Gigabyte product.

1-2 Feature Summary

CPU	<ul style="list-style-type: none"> ◆ Supports the latest Intel® Pentium® 4 LGA775 CPU ◆ Supports 533/400MHz FSB ◆ L2 cache varies with CPU
Chipset	<ul style="list-style-type: none"> ◆ Northbridge: Intel® 82845GV GMCH chipset ◆ Southbridge: Intel® 82801 (ICH4)
Memory	<ul style="list-style-type: none"> ◆ 2 DDR DIMM memory slots (supports up to 2GB memory) ◆ Supports dual channel DDR333/DDR266 DIMM ◆ Supports 2.5V DDR DIMM
Slots	<ul style="list-style-type: none"> ◆ 3 PCI slots
IDE Connections	<ul style="list-style-type: none"> ◆ 2 IDE connection (UDMA 33/ATA 66/ATA 100), allows connection of 4 IIDE devices
FDD Connections	<ul style="list-style-type: none"> ◆ 1 FDD connection, allows connection of 2 FDD devices
Peripherals	<ul style="list-style-type: none"> ◆ 1 parallel port supporting Normal/EPP/ECP mode ◆ 1 Serial port (COMA), 1 VGA port, COMB on board ◆ 6 USB 2.0/1.1 ports (rear x 2, front x 4 via cable) ◆ 1 front audio connector ◆ 1 PS/2 keyboard port ◆ 1 PS/2 mouse port
Onboard LAN	<ul style="list-style-type: none"> ◆ Onboard Realtek 8100C chip (10/100 Mbit) ◆ 1 RJ 45 port
Onboard Audio	<ul style="list-style-type: none"> ◆ Realtek ALC655 codec ◆ Supports Jack-Sensing function ◆ Supports 2 / 4 / 6 channel audio ◆ Supports Line Out / 2 front speaker ◆ Line In / 2 rear speaker (by s/w switch) ◆ Mic In / center & subwoofer (by s/w switch) ◆ Supports SPDIF In/Out connection ◆ CD In / AUX_In
I/O Control	<ul style="list-style-type: none"> ◆ IT8712F
Hardware Monitor	<ul style="list-style-type: none"> ◆ System voltage detection ◆ CPU temperature detection ◆ CPU / System fan speed detection ◆ CPU warning temperature ◆ CPU / System fan failure warning ◆ CPU smart fan control
BIOS	<ul style="list-style-type: none"> ◆ Use of licensed AWARD BIOS ◆ Supports Q-Flash
Additional Features	<ul style="list-style-type: none"> ◆ Supports @BIOS ◆ Supports EasyTune4
Overclocking	<ul style="list-style-type: none"> ◆ Over Clock via BIOS (DDR/CPU)
Form Factor	<ul style="list-style-type: none"> ◆ Micro ATX form factor; 24.4 cm x 22.0 cm

1-3 Installation of the CPU and Heatsink



Before installing the CPU, please comply with the following conditions:

1. Please make sure that the motherboard supports the CPU.
2. Please take note of the one indented corner of the CPU. If you install the CPU in the wrong direction, the CPU will not insert properly. If this occurs, please change the insert direction of the CPU.
3. Please add an even layer of heat sink paste between the CPU and heatsink.
4. Please make sure the heatsink is installed on the CPU prior to system use, otherwise overheating and permanent damage of the CPU may occur.
5. Please set the CPU host frequency in accordance with the processor specifications. It is not recommended that the system bus frequency be set beyond hardware specifications since it does not meet the required standards for the peripherals. If you wish to set the frequency beyond the proper specifications, please do so according to your hardware specifications including the CPU, graphics card, memory, hard drive, etc.



HT functionality requirement content :

Enabling the functionality of Hyper-Threading Technology for your computer system requires all of the following platform components:

- CPU: An Intel® Pentium 4 Processor with HT Technology
- Chipset: An Intel® Chipset that supports HT Technology
- BIOS: A BIOS that supports HT Technology and has it enabled
- OS: An operation system that has optimizations for HT Technology

1-3-1 Installation of the CPU

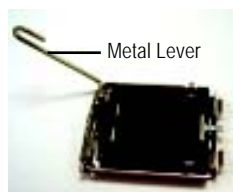

Fig. 1
Gently lift the metal lever located on the CPU socket to the upright position.



Fig. 2
Remove the plastic covering on the CPU socket.

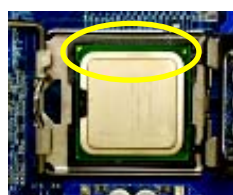

Fig. 3
Notice the small gold colored triangle located on the edge of the CPU socket. Align the indented corner of the CPU with the triangle and gently insert the CPU into position. (Grasping the CPU firmly between your thumb and forefinger, carefully place it into the socket in a straight and downwards motion. Avoid twisting or bending motions that might cause damage to the CPU during installation.)



Fig. 4
Once the CPU is properly inserted, please replace the load plate and push the metal lever back into its original position.

1-3-2 Installation of the Heatsink



Fig. 1
Please apply an even layer of heatsink paste on the surface of the installed CPU.

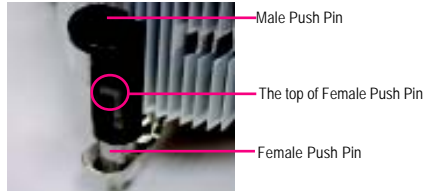

Fig. 2
(Turning the push pin along the direction of arrow is to remove the heatsink, on the contrary, is to install.) Please note the direction of arrow sign on the male push pin doesn't face inwards before installation. (This instruction is only for Intel boxed fan)

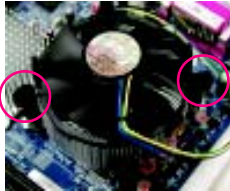

Fig. 3
Place the heatsink atop the CPU and make sure the push pins aim to the pin hole on the motherboard. Pressing down the push pins diagonally.



Fig. 4
Please make sure the Male and Female push pin are joined closely. (for detailed installation instructions, please refer to the heatsink installation section of the user manual)

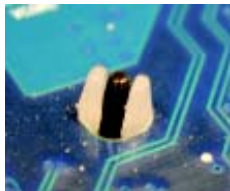

Fig. 5
Please check the back of motherboard after installing. If the push pin is inserted as the picture, the installation is complete.



Fig. 6
Finally, please attach the power connector of the heatsink to the CPU fan header located on the motherboard.



The heatsink may adhere to the CPU as a result of hardening of the heatsink paste. To prevent such an occurrence, it is suggested that either thermal tape rather than heat sink paste be used for heat dissipation or using extreme care when removing the heatsink.

1-4 Installation of Memory



Before installing the memory modules, please comply with the following conditions:

1. Please make sure that the memory used is supported by the motherboard. It is recommended that memory of similar capacity, specifications and brand be used.
2. Before installing or removing memory modules, please make sure that the computer power is switched off to prevent hardware damage.
3. Memory modules have a foolproof insertion design. A memory module can be installed in only one direction. If you are unable to insert the module, please switch the direction.

The motherboard supports DDR memory modules, whereby BIOS will automatically detect memory capacity and specifications. Memory modules are designed so that they can be inserted only in one direction. The memory capacity used can differ with each slot.

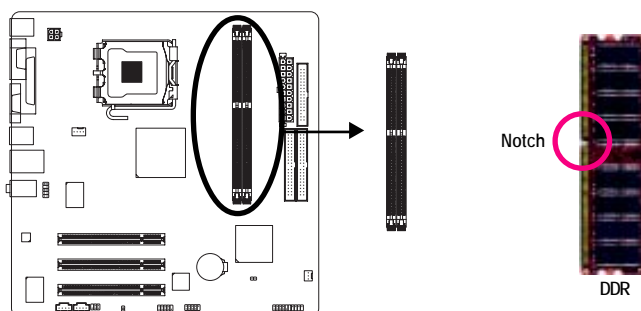

1. The DIMM slot has a notch, so the DIMM memory module can only fit in one direction.

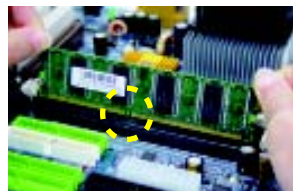

2. Insert the DIMM memory module vertically into the DIMM slot. Then push it down.



3. Close the plastic clip at both edges of the DIMM slots to lock the DIMM module. Reverse the installation steps when you wish to remove the DIMM module.



1-5 Install expansion cards

You can install your expansion card by following the steps outlined below:

1. Read the related expansion card's instruction document before install the expansion card into the computer.
2. Remove your computer's chassis cover, screws and slot bracket from the computer.
3. Press the expansion card firmly into expansion slot in motherboard.
4. Be sure the metal contacts on the card are indeed seated in the slot.
5. Replace the screw to secure the slot bracket of the expansion card.
6. Replace your computer's chassis cover.
7. Power on the computer, if necessary, setup BIOS utility of expansion card from BIOS.
8. Install related driver from the operating system.

Installing a PCI expansion card:



1-6 I/O Back Panel Introduction

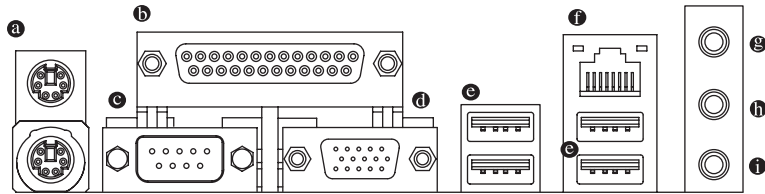

- a PS/2 Keyboard and PS/2 Mouse Connector**
 To install a PS/2 port keyboard and mouse, plug the mouse to the upper port (green) and the keyboard to the lower port (purple).
- b Parallel Port**
 The parallel port allows connection of a printer, scanner and other peripheral devices.
- c COM A (Serial Port)**
 Connects to serial-based mouse or data processing devices.
- d VGA Port**
 Monitor can be connected to VGA port.
- e USB port**
 Before you connect your device(s) into USB connector(s), please make sure your device(s) such as USB keyboard, mouse, scanner, zip, speaker...etc. have a standard USB interface. Also make sure your OS supports USB controller. If your OS does not support USB controller, please contact OS vendor for possible patch or driver upgrade. For more information please contact your OS or device(s) vendors.
- f LAN Port**
 The provided Internet connection is fast Ethernet, providing data transfer speeds of 10/100Mbps.
- g Line In**
 Devices like CD-ROM, walkman etc. can be connected to Line In jack.
- h Line Out**
 Connect the stereo speakers, earphone or front surround speakers to this connector.
- i MIC In**
 Microphone can be connected to MIC In jack.

1-7 Connectors Introduction

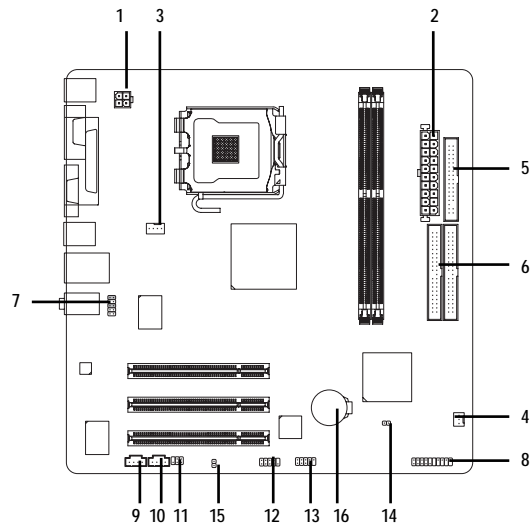

1) ATX_12V	9) CD_IN
2) ATX (Power Connector)	10) AUX_IN
3) CPU_FAN	11) SPDIF_IO
4) SYS_FAN	12) COMB
5) FDD	13) F_USB1
6) IDE1 / IDE2	14) CLR_CMOS
7) F_AUDIO	15) CI
8) F_PANEL	16) BAT

1/2) ATX_12V/ATX (Power Connector)

With the use of the power connector, the power supply can supply enough stable power to all the components on the motherboard. Before connecting the power connector, please make sure that all components and devices are properly installed. Align the power connector with its proper location on the motherboard and connect tightly.

The ATX_12V power connector mainly supplies power to the CPU. If the ATX_12V power connector is not connected, the system will not start.

Caution!

Please use a power supply that is able to handle the system voltage requirements. It is recommended that a power supply that can withstand high power consumption be used (300W or greater). If a power supply is used that does not provide the required power, the result can lead to an unstable system or a system that is unable to start.

If you use a 24-pin ATX power supply, please remove the small cover on the power connector on the motherboard before plugging in the power cord ; Otherwise, please do not remove it.

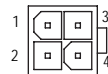
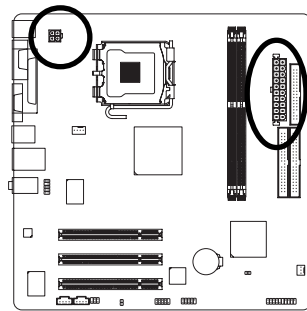

Pin No.	Definition
1	GND
2	GND
3	+12V
4	+12V

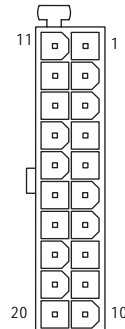

Pin No.	Definition
1	3.3V
2	3.3V
3	GND
4	+5V
5	GND
6	+5V
7	GND
8	Power Good
9	5V SB (stand by +5V)
10	+12V
11	3.3V
12	-12V
13	GND
14	PS_ON(soft on/off)
15	GND
16	GND
17	GND
18	-5V
19	+5V
20	+5V

3/4) CPU_FAN / SYS_FAN (Cooler Fan Power Connector)

The cooler fan power connector supplies a +12V power voltage via a 3-pin/4-pin (only for CPU_FAN) power connector and possesses a foolproof connection design.

Most coolers are designed with color-coded power connector wires. A red power connector wire indicates a positive connection and requires a +12V power voltage. The black connector wire is the ground wire (GND).

Please remember to connect the power to the cooler to prevent system overheating and failure.
Caution!

Please remember to connect the power to the CPU fan to prevent CPU overheating and failure.

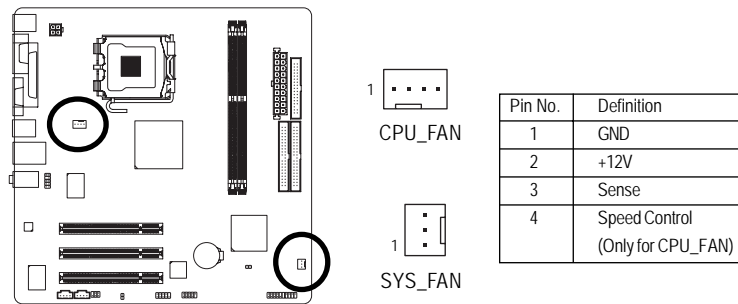

5) FDD (Floppy Connector)

The FDD connector is used to connect the FDD cable while the other end of the cable connects to the FDD drive. The types of FDD drives supported are: 360KB, 720KB, 1.2MB, 1.44MB and 2.88MB.

Please connect the red power connector wire to the pin1 position.

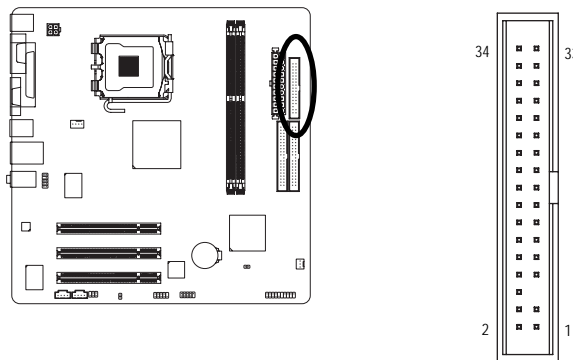

6) IDE1 / IDE2 (IDE1 / IDE2 Connector)

An IDE device connects to the computer via an IDE connector. One IDE connector can connect to one IDE cable, and the single IDE cable can then connect to two IDE devices (hard drive or optical drive). If you wish to connect two IDE devices, please set the jumper on one IDE device as Master and the other as Slave (for information on settings, please refer to the instructions located on the IDE device).

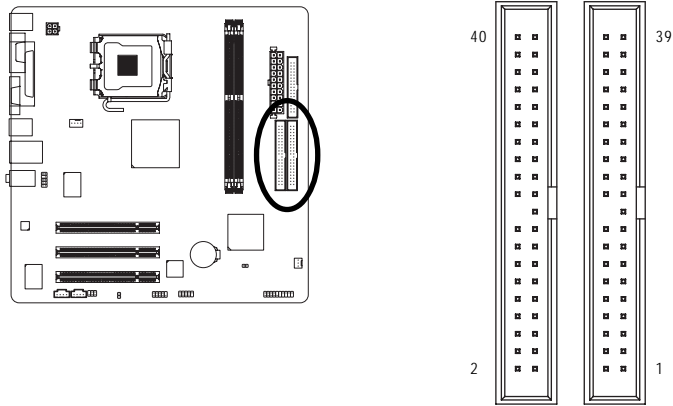

7) F_AUDIO (Front Audio Connector)

Please make sure the pin assignments on the cable are the same as the pin assignments of the F_AUDIO connector on the motherboard. To find out if the chassis you are buying support front audio panel connector, please contact your dealer. If you want to use "Front Audio" connector, you must remove the jumpers on pin 5-6, 9-10.

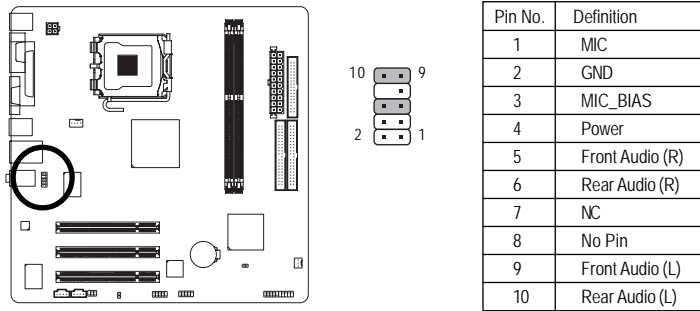

8) F_PANEL (Front Panel Jumper)

Please connect the power LED, PC speaker, reset switch and power switch etc of your chassis frontpanel to the F_PANEL connector according to the pin assignment below.

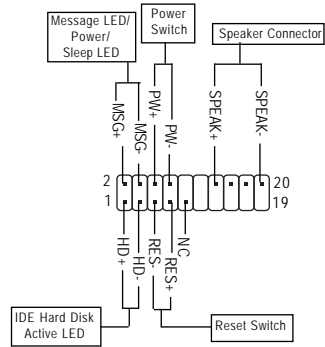
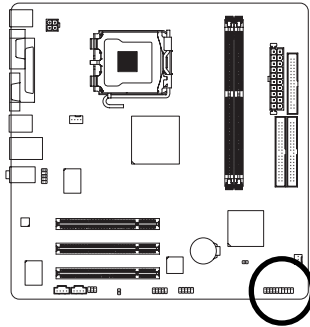

HD (IDE Hard Disk Active LED)	Pin 1: LED anode(+) Pin 2: LED cathode(-)
SPEAK (Speaker Connector)	Pin 1: Power Pin 2- Pin 3: NC Pin 4: Data(-)
RES (Reset Switch)	Open: Normal Close: Reset Hardware System
PW (Power Switch)	Open: Normal Close: Power On/Off
MSG(Message LED/Power/Sleep LED)	Pin 1: LED anode(+) Pin 2: LED cathode(-)
NC	NC

9) CD_IN (CD IN)

Connect CD-ROM or DVD-ROM audio out to the connector.

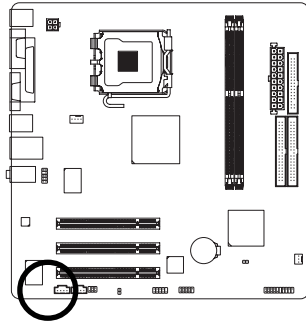

Pin No.	Definition
1	CD-L
2	GND
3	GND
4	CD-R

10) AUX_IN (AUX In Connector)

Connect other device (such as PCI TV Tuner audio out) to the connector.

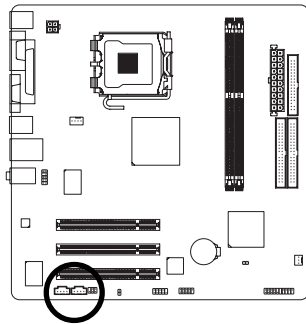

Pin No.	Definition
1	AUX-L
2	GND
3	GND
4	AUX-R

11) SPDIF_IO (SPDIF In/Out Connector)

The SPDIF output is capable of providing digital audio to external speakers or compressed AC3 data to an external Dolby Digital Decoder. Use this feature only when your stereo system has digital input function. Be careful with the polarity of the SPDIF_IO connector. Check the pin assignment carefully while you connect the SPDIF_IO cable, incorrect connection between the cable and connector will make the device unable to work or even damage it. For optional SPDIF_IO cable, please contact your local dealer.

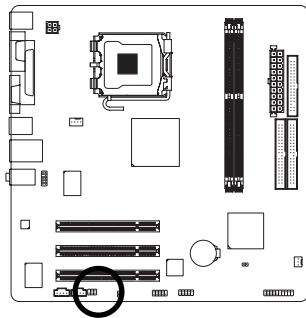

Pin No.	Definition
1	VCC
2	No Pin
3	SPDIF
4	SPDIFI
5	GND
6	GND

12) COMB (Serial Port Connector)

Be careful with the polarity of the COM connector. Check the pin assignment carefully while you connect the COM cable, incorrect connection between the cable and connector will make the device unable to work or even damage it. For optional COM cable, please contact your local dealer.

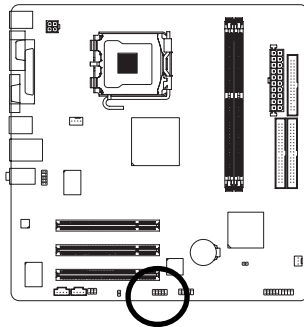

Pin No.	Definition
1	NDCDB-
2	NSIN B
3	NSOUT B
4	NDTRB-
5	GND
6	NDSRB-
7	NRTSB-
8	NCTSB-
9	NRIB-
10	No Pin

13) F_USB1 (Front USB Connector, Yellow)

Be careful with the polarity of the front USB connector. Check the pin assignment carefully while you connect the front USB cable, incorrect connection between the cable and connector will make the device unable to work or even damage it. For optional front USB cable, please contact your local dealer.

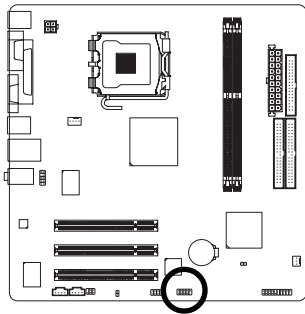



Pin No.	Definition
1	Power
2	Power
3	USB Dx-
4	USB Dy-
5	USB Dx+
6	USB Dy+
7	GND
8	GND
9	No Pin
10	NC

14) CLR_CMOS (Clear CMOS)

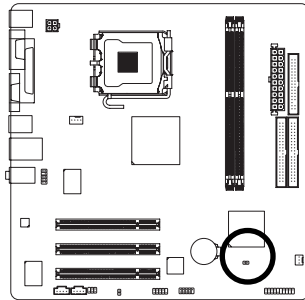
You may clear the CMOS data to its default values by this jumper. To clear CMOS, temporarily short 1-2 pin. Default doesn't include the "Shunter" to prevent from improper use this jumper.



 1 Open: Normal

 1 Short: Clear CMOS

15) CI (CASE OPEN)

This 2-pin connector allows your system to enable or disable the "Case Open" item in BIOS, if the system case begin remove.

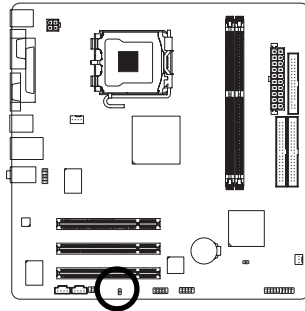

1

Pin No.	Definition
1	Signal
2	GND

16) BAT(Battery)

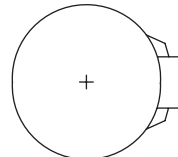
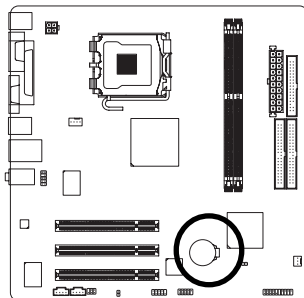

- ❖ Danger of explosion if battery is incorrectly replaced.
- ❖ Replace only with the same or equivalent type recommended by the manufacturer.
- ❖ Dispose of used batteries according to the manufacturer's instructions.

If you want to erase CMOS...

1. Turn OFF the computer and unplug the power cord.
2. Remove the battery, wait for 30 second.
3. Re-install the battery.
4. Plug the power cord and turn ON the computer.

Chapter 2 BIOS Setup

BIOS (Basic Input and Output System) includes a CMOS SETUP utility which allows user to configure required settings or to activate certain system features.

The CMOS SETUP saves the configuration in the CMOS SRAM of the motherboard.

When the power is turned off, the battery on the motherboard supplies the necessary power to the CMOS SRAM.

When the power is turned on, pushing the button during the BIOS POST (Power-On Self Test) will take you to the CMOS SETUP screen. You can enter the BIOS setup screen by pressing "Ctrl + F1".

When setting up BIOS for the first time, it is recommended that you save the current BIOS to a disk in the event that BIOS needs to be reset to its original settings. If you wish to upgrade to a new BIOS, either Gigabyte's Q-Flash or @BIOS utility can be used.

Q-Flash allows the user to quickly and easily update or backup BIOS without entering the operating system. @BIOS is a Windows-based utility that does not require users to boot to DOS before upgrading BIOS but directly download and update BIOS from the Internet.

CONTROL KEYS

<↑><↓><←><→>	Move to select item
<Enter>	Select Item
<Esc>	Main Menu - Quit and not save changes into CMOS Status Page Setup Menu and Option Page Setup Menu - Exit current page and return to Main Menu
<Page Up>	Increase the numeric value or make changes
<Page Down>	Decrease the numeric value or make changes
<F1>	General help, only for Status Page Setup Menu and Option Page Setup Menu
<F2>	Item Help
<F5>	Restore the previous CMOS value from CMOS, only for Option Page Setup Menu
<F6>	Load the file-safe default CMOS value from BIOS default table
<F7>	Load the Optimized Defaults
<F8>	Q-Flash utility
<F9>	System Information
<F10>	Save all the CMOS changes, only for Main Menu

Main Menu

The on-line description of the highlighted setup function is displayed at the bottom of the screen.

Status Page Setup Menu / Option Page Setup Menu

Press F1 to pop up a small help window that describes the appropriate keys to use and the possible selections for the highlighted item. To exit the Help Window press <Esc>.

The Main Menu (For example: BIOS Ver. : E2)

Once you enter Award BIOS CMOS Setup Utility, the Main Menu (as figure below) will appear on the screen. Use arrow keys to select among the items and press <Enter> to accept or enter the sub-menu.

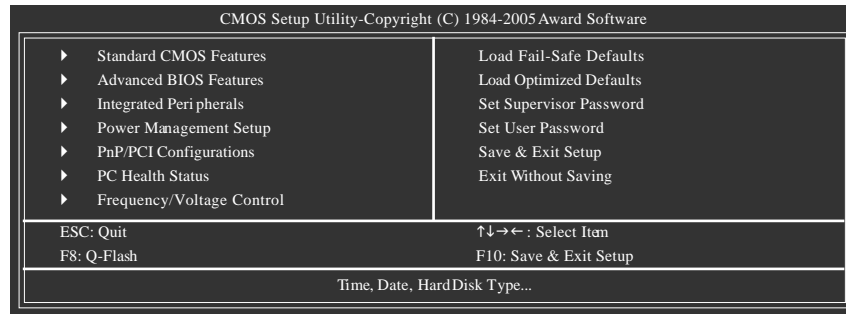

NOTE

If you can't find the setting you want, please press "Ctrl+F1" to search the advanced option hidden.

Please Load Optimized Defaults in the BIOS when somehow the system works not stable as usual. This action makes the system reset to the default for stability.

■ Standard CMOS Features

This setup page includes all the items in standard compatible BIOS.

■ Advanced BIOS Features

This setup page includes all the items of Award special enhanced features.

■ Integrated Peripherals

This setup page includes all onboard peripherals.

■ Power Management Setup

This setup page includes all the items of Green function features.

■ PnP/PCI Configuration

This setup page includes all the configurations of PCI & PnP ISA resources.

■ PC Health Status

This setup page is the System auto detect Temperature, voltage, fan, speed.

■ Frequency/Voltage Control

This setup page is control CPU clock and frequency ratio.

■ Load Fail-Safe Defaults

Fail-Safe Defaults indicates the value of the system parameters which the system would be in safe configuration.

■ Load Optimized Defaults

Optimized Defaults indicates the value of the system parameters which the system would be in best performance configuration.

■ Set Supervisor Password

Change, set, or disable password. It allows you to limit access to the system and Setup, or just to Setup.

- **Set User Password**
Change, set, or disable password. It allows you to limit access to the system.
- **Save & Exit Setup**
Save CMOS value settings to CMOS and exit setup.
- **Exit Without Saving**
Abandon all CMOS value changes and exit setup.

2-1 Standard CMOS Features

CMOS Setup Utility-Copyright (C) 1984-2004 Award Software Standard CMOS Features		
Date (mm:dd:yy)	Thu, Jan 20 2005	Item Help
Time (hh:mm:ss)	22:31:24	Menu Level ▶
▶ IDE Primary Master	[None]	Change the day, month, year
▶ IDE Primary Slave	[None]	<Week>
▶ IDE Secondary Master	[None]	Sun. to Sat.
▶ IDE Secondary Slave	[None]	<Month>
Drive A	[1.44M, 3.5"]	Jan. to Dec.
Drive B	[None]	<Day>
Floppy 3 Mode Support	[Disabled]	1 to 31 (or maximum allowed in the month)
Halt On	[All, But Keyboard]	<Year>
Base Memory	640K	1999 to 2098
Extended Memory	127M	
Total Memory	128M	
↑↓→←: Move Enter: Select +/-/PU/PD: Value F10: Save ESC: Exit F1: General Help F5: Previous Values F6: Fail-Safe Default F7: Optimized Defaults		

☞ Date

The date format is <week>, <month>, <day>, <year>.

- ▶▶ Week The week, from Sun to Sat, determined by the BIOS and is display only
- ▶▶ Month The month, Jan. Through Dec.
- ▶▶ Day The day, from 1 to 31 (or the maximum allowed in the month)
- ▶▶ Year The year, from 1999 through 2098

☞ Time

The times format in <hour> <minute> <second>. The time is calculated base on the 24-hour military-time clock. For example, 1 p.m. is 13:00:00.

☞ IDE Primary/ Secondary Master, Slave

- ▶▶ IDE HDD Auto-Detection Press "Enter" to select this option for automatic device detection.
- ▶▶ IDE Primary/Secondary Master(Slave) IDE Device Setup. You can use one of three methods:
 - Auto Allows BIOS to automatically detect IDE devices during POST(default)
 - None Select this if no IDE devices are used and the system will skip the automatic detection step and allow for faster system start up.
 - Manual User can manually input the correct settings
- ▶▶ Access Mode Use this to set the access mode for the hard drive. The four options are: CHS/LBA/Large/Auto(default:Auto)

Hard drive information should be labeled on the outside drive casing. Enter the appropriate option based on this information.

- ▶▶ Cylinder Number of cylinders
- ▶▶ Head Number of heads
- ▶▶ Precomp Write precomp
- ▶▶ Landing Zone Landing zone
- ▶▶ Sector Number of sectors

If a hard disk has not been installed, select NONE and press <Enter>.

☞ Drive A / Drive B

The category identifies the types of floppy disk drive A or drive B that has been installed in the computer.

- ▶▶ None No floppy drive installed
- ▶▶ 360K, 5.25" 5.25 inch PC-type standard drive; 360K byte capacity.
- ▶▶ 1.2M, 5.25" 5.25 inch AT-type high-density drive; 1.2M byte capacity
(3.5 inch when 3 Mode is Enabled).
- ▶▶ 720K, 3.5" 3.5 inch double-sided drive; 720K byte capacity
- ▶▶ 1.44M, 3.5" 3.5 inch double-sided drive; 1.44M byte capacity.
- ▶▶ 2.88M, 3.5" 3.5 inch double-sided drive; 2.88M byte capacity.

☞ Floppy 3 Mode Support (for Japan Area)

- ▶▶ Disabled Normal Floppy Drive. (Default value)
- ▶▶ Drive A Drive A is 3 mode Floppy Drive.
- ▶▶ Drive B Drive B is 3 mode Floppy Drive.
- ▶▶ Both Drive A & B are 3 mode Floppy Drives.

☞ Halt on

The category determines whether the computer will stop if an error is detected during power up.

- ▶▶ No Errors The system boot will not stop for any error that may be detected and you will be prompted.
- ▶▶ All Errors Whenever the BIOS detects a non-fatal error the system will be stopped.
- ▶▶ All, But Keyboard The system boot will not stop for a keyboard error; it will stop for all other errors. (Default value)
- ▶▶ All, But Diskette The system boot will not stop for a disk error; it will stop for all other errors.
- ▶▶ All, But Disk/Key The system boot will not stop for a keyboard or disk error; it will stop for all other errors.

☞ Memory

The category is display-only which is determined by POST (Power On Self Test) of the BIOS.

▶▶ Base Memory

The POST of the BIOS will determine the amount of base (or conventional) memory installed in the system.

The value of the base memory is typically 512K for systems with 512K memory installed on the motherboard, or 640K for systems with 640K or more memory installed on the motherboard.

▶▶ Extended Memory

The BIOS determines how much extended memory is present during the POST.

This is the amount of memory located above 1 MB in the CPU's memory address map.

2-2 Advanced BIOS Features

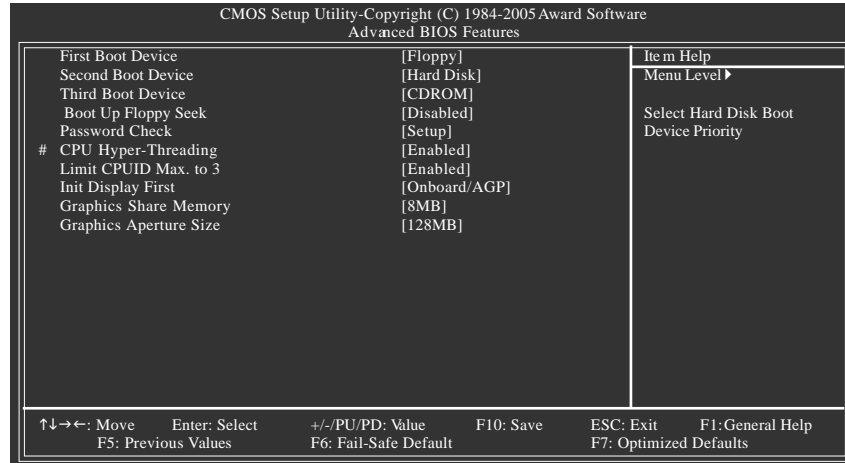

 " # " System will detect automatically and show up when you install the Intel® Pentium® 4 processor with HT Technology.

First / Second / Third Boot Device

- ▶▶ Floppy Select your boot device priority by Floppy.
- ▶▶ LS120 Select your boot device priority by LS120.
- ▶▶ Hard Disk Select your boot device priority by Hard Disk.
- ▶▶ CDROM Select your boot device priority by CDROM.
- ▶▶ ZIP Select your boot device priority by ZIP.
- ▶▶ USB-FDD Select your boot device priority by USB-FDD.
- ▶▶ USB-ZIP Select your boot device priority by USB-ZIP.
- ▶▶ USB-CDROM Select your boot device priority by USB-CDROM.
- ▶▶ USB-HDD Select your boot device priority by USB-HDD.
- ▶▶ LAN Select your boot device priority by LAN.
- ▶▶ Disabled Disable this function.

Boot Up Floppy Seek

During POST, BIOS will determine the floppy disk drive installed is 40 or 80 tracks. 360K type is 40 tracks 720K, 1.2M and 1.44M are all 80 tracks.

- ▶▶ Enabled BIOS searches for floppy disk drive to determine it is 40 or 80 tracks. Note that BIOS can not tell from 720K, 1.2M or 1.44M drive type as they are all 80 tracks.
- ▶▶ Disabled BIOS will not search for the type of floppy disk drive by track number. Note that there will not be any warning message if the drive installed is 360K. (Default value)

☞ **Password Check**

- ▶▶ Setup The system will boot but will not access to Setup page if the correct password is not entered at the prompt. (Default value)
- ▶▶ System The system will not boot and will not access to Setup page if the correct password is not entered at the prompt.

☞ **CPU Hyper-Threading**

- ▶▶ Enabled Enables CPU Hyper Threading Feature. Please note that this feature is only working for operating system with multi processors mode supported. (Default value)
- ▶▶ Disabled Disables CPU Hyper Threading.

☞ **Limit CUID Max. to 3**

- ▶▶ Enabled Limit CUID Maximum value to 3 when use older OS like NT4. (Default value)
- ▶▶ Disabled Disables CUID Limit for windows XP.

☞ **Init Display First**

Select the first initiation of monitor or display from AGP or PCI VGA card.

- ▶▶ Onboard/AGP Set Init display first to AGP. (Default value)
- ▶▶ PCI Set Init display first to PCI.

☞ **Graphics Memory Size**

- ▶▶ 128MB Driver use selected sized of system memory for 3D texturing to increase graphics performance. (Default value)
- ▶▶ Disabled Disable onboard graphics chip function.

☞ **Graphics Share Memory**

- ▶▶ 8MB Share 8MB system memory preallocated for frame buffer. (Default value)
- ▶▶ 1MB Share 1MB system memory preallocated for frame buffer.

2-3 Integrated Peripherals

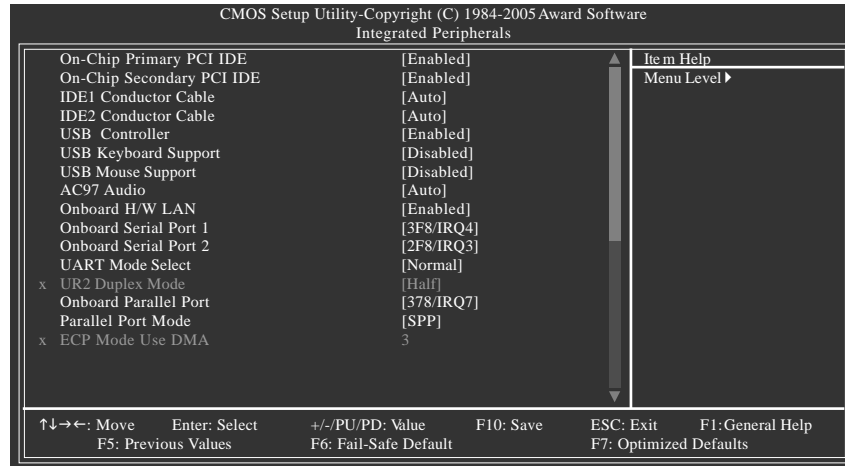

☞ On-Chip Primary PCI IDE

- ▶▶ Enabled Enable onboard 1st channel IDE port. (Default value)
- ▶▶ Disabled Disable onboard 1st channel IDE port.

☞ On-Chip Secondary PCI IDE

- ▶▶ Enabled Enable onboard 2nd channel IDE port. (Default value)
- ▶▶ Disabled Disable onboard 2nd channel IDE port.

☞ IDE1 Conductor Cable

- ▶▶ Auto Will be automatically detected by BIOS. (Default Value)
- ▶▶ ATA66/100 Set IDE1 Conductor Cable to ATA66/100 (Please make sure your IDE device and cable is compatible with ATA66/100).
- ▶▶ ATA33 Set IDE1 Conductor Cable to ATA33 (Please make sure your IDE device and cable is compatible with ATA33).

☞ IDE2 Conductor Cable

- ▶▶ Auto Will be automatically detected by BIOS. (Default Value)
- ▶▶ ATA66/100 Set IDE2 Conductor Cable to ATA66/100 (Please make sure your IDE device and cable is compatible with ATA66/100).
- ▶▶ ATA33 Set IDE2 Conductor Cable to ATA33 (Please make sure your IDE device and cable is compatible with ATA33).

☞ USB Controller

- ▶▶ Enabled Enable USB Controller. (Default value)
- ▶▶ Disabled Disable USB Controller.

- ☞ **USB Keyboard Support**
 - ▶▶ Enabled Enable USB Keyboard Support.
 - ▶▶ Disabled Disable USB Keyboard Support. (Default value)
- ☞ **USB Mouse Support**
 - ▶▶ Enabled Enable USB Mouse Support.
 - ▶▶ Disabled Disable USB Mouse Support. (Default value)
- ☞ **AC97 Audio**
 - ▶▶ Auto Enable onboard AC'97 audio function. (Default Value)
 - ▶▶ Disabled Disable this function.
- ☞ **Onboard H/W LAN**
 - ▶▶ Enabled Enable Onboard H/W LAN function. (Default value)
 - ▶▶ Disabled Disable this function.
- ☞ **Onboard Serial Port 1**
 - ▶▶ Auto BIOS will automatically setup the port 1 address.
 - ▶▶ 3F8/IRQ4 Enable onboard Serial port 1 and address is 3F8/IRQ4. (Default value)
 - ▶▶ 2F8/IRQ3 Enable onboard Serial port 1 and address is 2F8/IRQ3.
 - ▶▶ 3E8/IRQ4 Enable onboard Serial port 1 and address is 3E8/IRQ4.
 - ▶▶ 2E8/IRQ3 Enable onboard Serial port 1 and address is 2E8/IRQ3.
 - ▶▶ Disabled Disable onboard Serial port 1.
- ☞ **Onboard Serial Port 2**
 - ▶▶ Auto BIOS will automatically setup the port 2 address.
 - ▶▶ 3F8/IRQ4 Enable onboard Serial port 2 and address is 3F8/IRQ4.
 - ▶▶ 2F8/IRQ3 Enable onboard Serial port 2 and address is 2F8/IRQ3. (Default value)
 - ▶▶ 3E8/IRQ4 Enable onboard Serial port 2 and address is 3E8/IRQ4.
 - ▶▶ 2E8/IRQ3 Enable onboard Serial port 2 and address is 2E8/IRQ3.
 - ▶▶ Disabled Disable onboard Serial port 2.
- ☞ **UART Mode Select**

This item allows you to determine which Infra Red(IR) function of Onboard I/O chip.

 - ▶▶ Normal Set onboard I/O chip UART to Normal Mode. (Default Value)
 - ▶▶ ASKIR Set onboard I/O chip UART to ASKIR Mode.
 - ▶▶ IrDA Set onboard I/O chip UART to IrDA Mode.
- ☞ **UR2 Duplex Mode**

This feature allows you to select IR mode.

This function will available when "UART Mode Select" doesn't set at Normal.

 - ▶▶ Half IR Function Duplex Half. (Default value)
 - ▶▶ Full IR Function Duplex Full.
- ☞ **Onboard Parallel port**
 - ▶▶ Disabled Disable onboard LPT port.
 - ▶▶ 378/IRQ7 Enable onboard LPT port and address is 378/IRQ7. (Default value)
 - ▶▶ 278/IRQ5 Enable onboard LPT port and address is 278/IRQ5.
 - ▶▶ 3BC/IRQ7 Enable onboard LPT port and address is 3BC/IRQ7.

- ☞ **Parallel Port Mode**
 - ▶▶ SPP Using Parallel port as Standard Parallel Port. (Default value)
 - ▶▶ EPP Using Parallel port as Enhanced Parallel Port.
 - ▶▶ ECP Using Parallel port as Extended Capabilities Port.
 - ▶▶ ECP+EPP Using Parallel port as ECP & EPP mode.
- ☞ **ECP Mode Use DMA**
 - ▶▶ 3 Set ECP Mode Use DMA to 3. (Default value)
 - ▶▶ 1 Set ECP Mode Use DMA to 1.

2-4 Power Management Setup

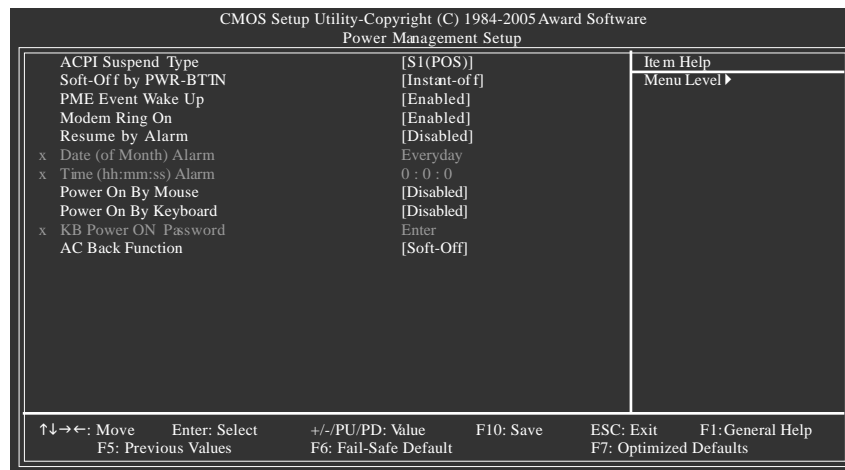

- ☞ **ACPI Suspend Type**
 - ▶▶ S1(POS) Set ACPI suspend type to S1/POS(Power On Suspend). (Default value)
 - ▶▶ S3(STR) Set ACPI suspend type to S3/STR(Suspend To RAM).
- ☞ **Soft-off by PWR-BTTN**
 - ▶▶ Instant-off Press power button then Power off instantly. (Default value)
 - ▶▶ Delay 4 Sec. Press power button 4 sec. to Power off. Enter suspend if button is pressed less than 4 sec.
- ☞ **PME Event Wake Up**
 - ▶▶ Disabled Disable this function.
 - ▶▶ Enabled Enable PME Event Wake up. (Default value)
- ☞ **Modem Ring On**
 - ▶▶ Disabled Disable Modem Ring On function.
 - ▶▶ Enabled Enable Modem Ring On function. (Default value)

☞ Resume by Alarm

You can set "Resume by Alarm" item to enabled and key in Date/time to power on system.

- ▶▶ Disabled Disable this function. (Default value)
- ▶▶ Enabled Enable alarm function to POWER ON system.

If RTC Alarm Lead To Power On is Enabled.

- ▶▶ Date (of Month) Alarm : Everyday, 1~31
- ▶▶ Time (hh: mm: ss) Alarm : (0-23) : (0-59) : (0-59)

☞ Power On By Mouse

- ▶▶ Disabled Disable this function. (Default value)
- ▶▶ Double Click Double click on PS/2 mouse left button to power on the system.

☞ Power On By Keyboard

- ▶▶ Password Enter from 1 to 5 characters to set the Keyboard Power On Password.
- ▶▶ Disabled Disabled this function. (Default value)
- ▶▶ Keyboard 98 If your keyboard have "POWER Key" button, you can press the key to power on the system.

☞ KB Power ON Password

When "Power On by Keyboard" set at Password, you can set the password here.

- ▶▶ Enter Input password (from 1 to 5 characters) and press Enter to set the Keyboard Power On password.

☞ AC Back Function

- ▶▶ Soft-Off When AC-power back to the system, the system will be in "Off" state. (Default value)
- ▶▶ Full-On When AC-power back to the system, the system always in "On" state.
- ▶▶ Memory When AC-power back to the system, the system will return to the Last state before AC-power off.

2-5 PnP/PCI Configurations

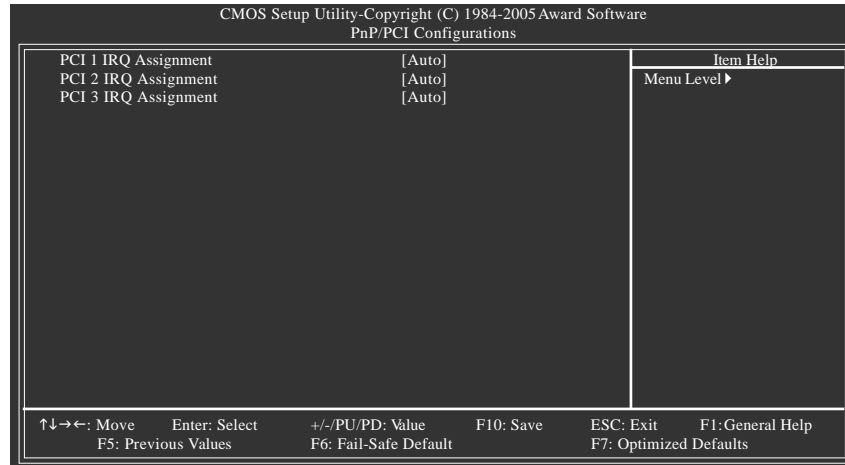

- ☞ **PCI 1 IRQ Assignment**
 - ▶▶ Auto Auto assign IRQ to PCI 1. (Default value)
 - ▶▶ 3,4,5,7,9,10,11,12,14,15 Set IRQ 3,4,5,7,9,10,11,12,14,15 to PCI 1.
- ☞ **PCI 2 IRQ Assignment**
 - ▶▶ Auto Auto assign IRQ to PCI 2. (Default value)
 - ▶▶ 3,4,5,7,9,10,11,12,14,15 Set IRQ 3,4,5,7,9,10,11,12,14,15 to PCI 2.
- ☞ **PCI 3 IRQ Assignment**
 - ▶▶ Auto Auto assign IRQ to PCI 3. (Default value)
 - ▶▶ 3,4,5,7,9,10,11,12,14,15 Set IRQ 3,4,5,7,9,10,11,12,14,15 to PCI 3.

☞ **CPU/SYSTEM FAN Fail Warning**

- ▶▶ Disabled Fan warning function disable. (Default value)
- ▶▶ Enabled Fan warning function enable.

☞ **CPU Smart FAN Control**

- ▶▶ Disabled Disable this function.
- ▶▶ Enabled Enable CPU Smart Fan control function. (Default value)
 - a. When the CPU temperature is higher than 65 degrees Celsius, CPU fan will run at full speed.
 - b. The speed of CPU fan will increase linearly depend on the temperature if the temperature is more than 41 degree and less than 65 degree.
 - c. When the CPU temperature is lower than 40 degrees Celsius, CPU fan will be disable.

2-7 Frequency/Voltage Control

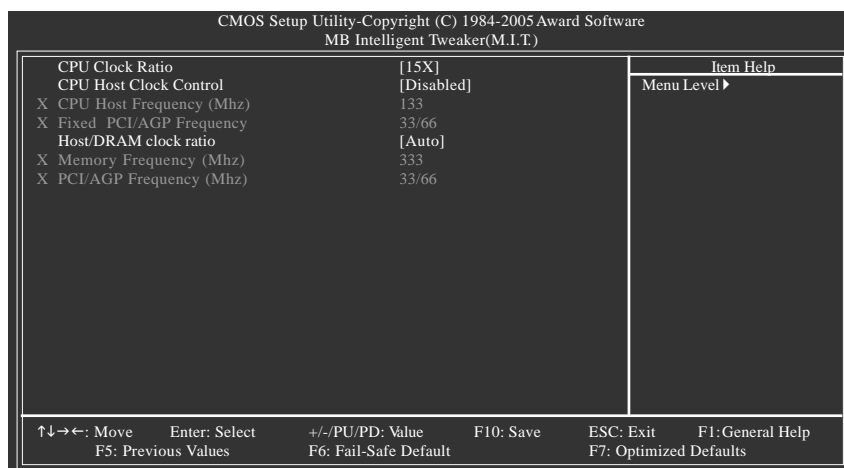

Incorrect using these features may cause your system broken. For power end-user use only.

☞ **CPU Clock Ratio**

- This setup option will automatically assign by CPU detection.
- The option will display "Locked" and read only if the CPU ratio is not changeable.

☞ **CPU Host Clock Control**

Note: If system hangs up before enter CMOS setup utility, wait for 20 sec for times out reboot.
When time out occur, system will reset and run at CPU default Host clock at next boot.

- ▶▶ Disabled Disable CPU Host Clock Control. (Default value)
- ▶▶ Enabled Enable CPU Host Clock Control.

☞ **CPU Host Frequency (MHz)**

- ▶▶ 100MHz ~ 355MHz Set CPU Host Clock from 100MHz to 355MHz.

Incorrect using it may cause your system broken. For power End-User use only!

☞ **Fixed PCI/AGP Frequency(Mhz)**

- ▶▶ Fixed PCI/AGP frequency.

☞ **Host/DRAM Clock Ratio**

(Warning: wrong frequency may make system can't boot, clear CMOS to overcome wrong frequency issue)

- ▶▶ 2.0 Memory Frequency = Host clock X 2.0.
- ▶▶ 2.5 Memory Frequency = Host clock X 2.5.
- ▶▶ Auto Set Memory frequency by DRAM SPD data. (Default value)

☞ **Memory Frequency (Mhz)**

The values depend on "Memory Frequency For" item.

☞ **PCI/AGP Frequency(Mhz)**

- ▶▶ The values depend on PCI/AGP frequency.

2-8 Load Fail-Safe Defaults

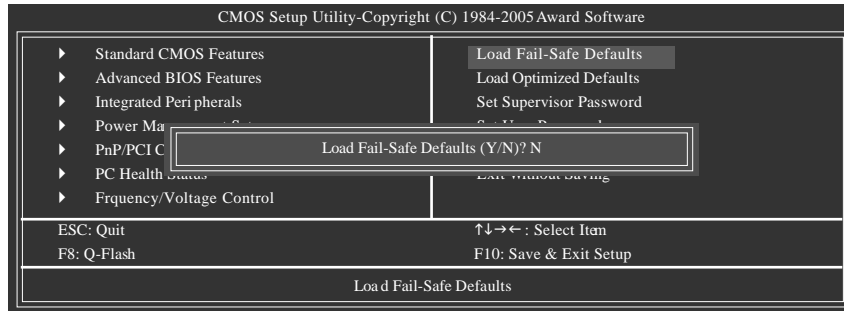

Fail-Safe defaults contain the most appropriate values of the system parameters that allow minimum system performance.

2-9 Load Optimized Defaults

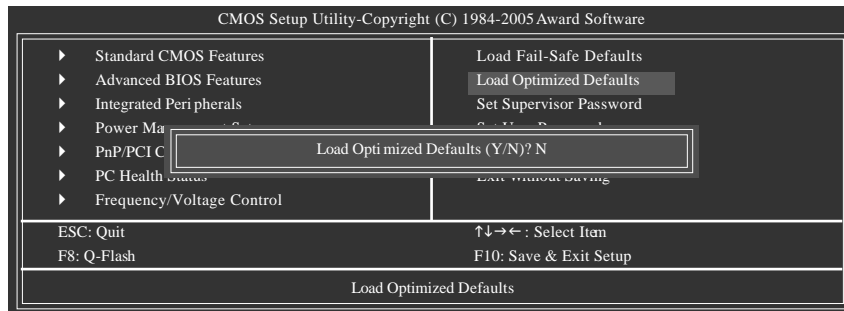

Selecting this field loads the factory defaults for BIOS and Chipset Features which the system automatically detects.

2-10 Set Supervisor/User Password

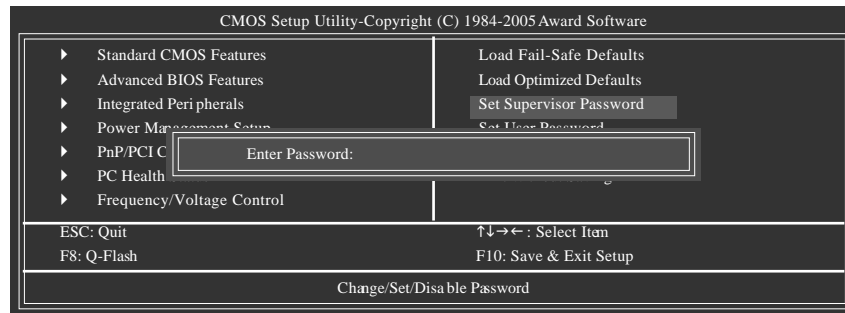

When you select this function, the following message will appear at the center of the screen to assist you in creating a password.

Type the password, up to eight characters, and press <Enter>. You will be asked to confirm the password. Type the password again and press <Enter>. You may also press <Esc> to abort the selection and not enter a password.

To disable password, just press <Enter> when you are prompted to enter password. A message "PASSWORD DISABLED" will appear to confirm the password being disabled. Once the password is disabled, the system will boot and you can enter Setup freely.

The BIOS Setup program allows you to specify two separate passwords: SUPERVISOR PASSWORD and a USER PASSWORD. When disabled, anyone may access all BIOS Setup program function. When enabled, the Supervisor password is required for entering the BIOS Setup program and having full configuration fields, the User password is required to access only basic items.

If you select "System" at "Password Check" in Advance BIOS Features Menu, you will be prompted for the password every time the system is rebooted or any time you try to enter Setup Menu.

If you select "Setup" at "Password Check" in Advance BIOS Features Menu, you will be prompted only when you try to enter Setup.

2-11 Save & Exit Setup

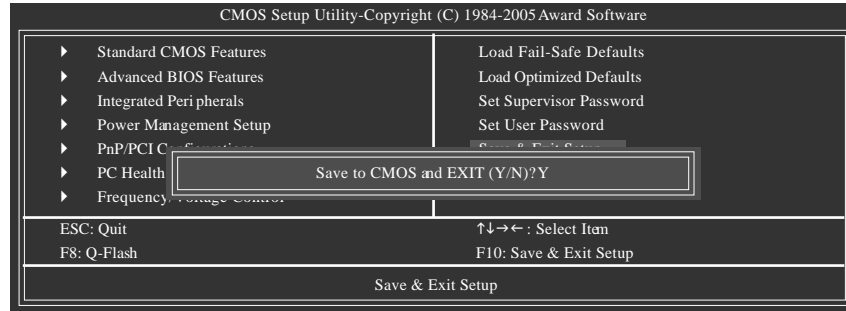

Type "Y" will quit the Setup Utility and save the user setup value to RTC CMOS.
Type "N" will return to Setup Utility.

2-12 Exit Without Saving

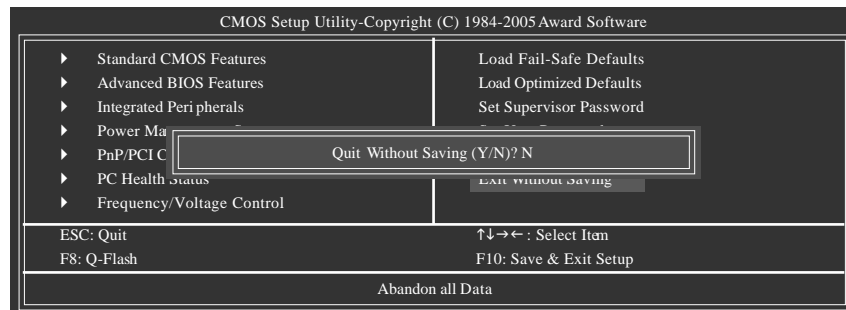

Type "Y" will quit the Setup Utility without saving to RTC CMOS.
Type "N" will return to Setup Utility.

Chapter 3 Install Drivers

3-1 Install Chipset Drivers





NOTE

Pictures below are shown in Windows XP

Insert the driver CD-title that came with your motherboard into your CD-ROM drive, the driver CD-title will auto start and show the installation guide. If not, please double click the CD-ROM device icon in "My computer", and execute the setup.exe.

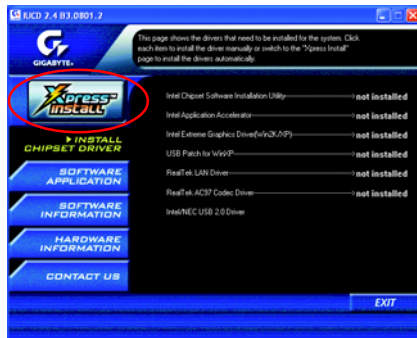
This page shows the drivers that need to be installed for the system. Click each item to install the driver manually or switch to the  to install the drivers automatically.



The "Xpress Install" uses the "Click and Go" technology to install the drivers automatically. Just select the drivers you want then click the "GO" button. The  will finish the installation for you automatically.

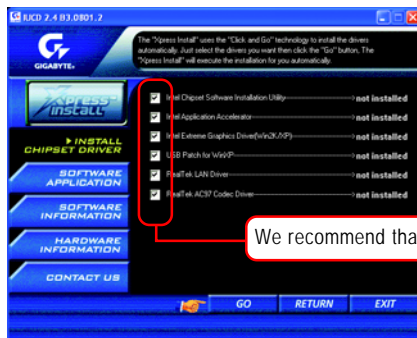

NOTE

Message: Some device drivers will restart your system automatically. After restarting your system the "Xpress Install" will continue to install other drivers.

We recommend that you install all components in the list.

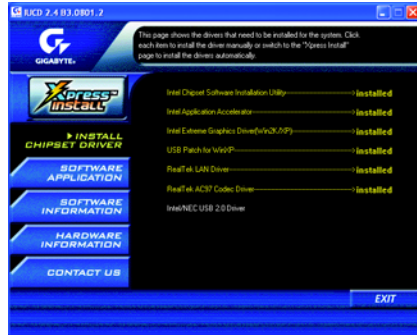

Driver install finished !
You have to reboot system !

Item Description

- Intel Chipset Software Installation Utility
Tell the operating system how the chipset components will be configured.
- Intel Application Accelerator
Designed to improve performance of the storage sub-system and overall system performance.
- Intel Extreme Graphics Driver
For Intel® 845G/GL/GE/GV Chipsets.
- USB Patch for WinXP
This patch driver can help you to resolve the USB device wake up S3 hang up issue in XP.
- RealTek LAN Driver
Realtek 10/100 driver for 81XX series chipset.
- RealTek AC97 Codec Driver
For Intel® ICH/ICH2/ICH4/ICH5 AC97 audio.
- USB Driver Patch
This patch driver can help you to resolve some USB device issue on XP.
- Intel/NEC USB 2.0 Driver
It is recommended that you use the Microsoft Windows update for the most updated driver for XP/2K.



For USB2.0 driver support under Windows XP operating system, please use Windows Service Pack. After install Windows Service Pack, it will show a question mark "?" in "Universal Serial Bus controller" under "Device Manager". Please remove the question mark and restart the system (System will auto-detect the right USB2.0 driver).

3-2 Software Application

This page reveals the value-added software developed by Gigabyte and its worldwide partners.



- **Gigabyte Windows Utilities Manager (GWUM)**
This utility can integrate the Gigabyte's applications in the system tray
- **Gigabyte Management Tool (GMT)**
A useful tool which can manage the computer via the network
- **EasyTune 4**
Powerful utility that integrates the overclocking and hardware monitoring functions
- **DMI Viewer**
Windows based utility which is used to browse the DMI/SMBIOS information of the system
- **Face-Wizard**
New utility for adding BIOS logo
- **@BIOS**
Gigabyte windows flash BIOS utility
- **Acrobat e-Book**
Useful utility from Adobe
- **Acrobat Reader**
Popular utility from Adobe for reading .PDF file format documents
- **Norton Internet Security (NIS)**
Integrated utility which includes anti-virus, ads, etc.
- **DirectX 9.0**
Install Microsoft DirectX 9 to enable 3D hardware acceleration that support for operating system to achieve better 3D performance.

3-3 Software Information

This page lists the contents of softwares and drivers in this CD title.



3-4 Hardware Information

This page lists all device you have for this motherboard.



Chapter 4 Appendix

4-1 Unique Software Utilities

4-1-1 EasyTune 4 Installation

Powerful utility that integrates the overclocking and hardware monitoring functions

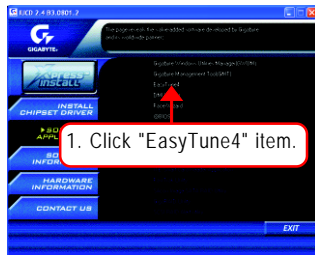

(1)

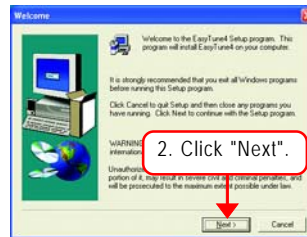

(2)

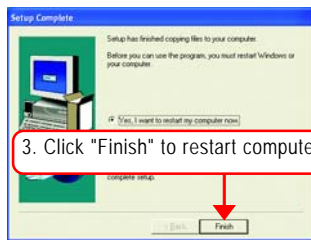

(3)



(4)

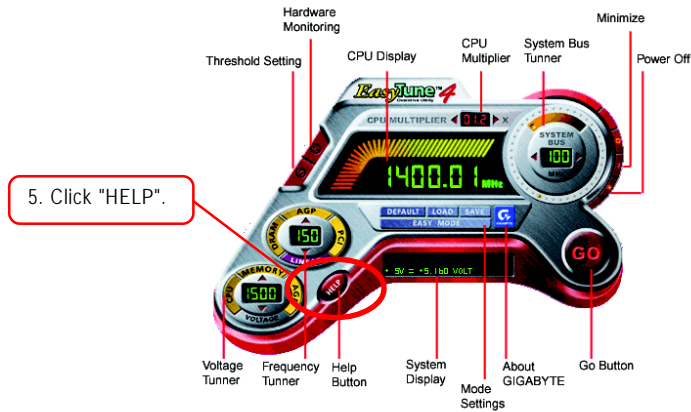

4-1-2 Xpress Recovery Introduction



What is Xpress Recovery ?

Xpress Recovery is a utility used to back up and restore an OS partition. If the hard drive is not working properly, the user can restore the drive to its original state.



1. Supports FAT16, FAT32, and NTFS formats
2. Must be connected to the IDE1 Master
3. Allows installation of only one OS
4. Must be used with an IDE hard disk supporting HPA
5. The first partition must be set as the boot partition. When the boot partition is backed up, please do not alter its size.
6. Xpress Recovery is recommended when using Ghost to return boot manager to NTFS format.

How to use the Xpress Recovery

1. Boot from CD-ROM (BMP Mode)

Enter the BIOS menu, select "Advanced BIOS Feature" and set to boot from CD-ROM. Insert the provided driver CD into your CD drive, then save and exit the BIOS menu. Once the computer has restarted, the phrase "Boot from CD:" will appear at the bottom left-hand corner of the screen. When "Boot from CD:" appears, press any key to enter Xpress Recovery.

Once you have completed this step, subsequent access to Xpress Recovery can also function by pressing the F9 key during computer power on.



Boot from CD:

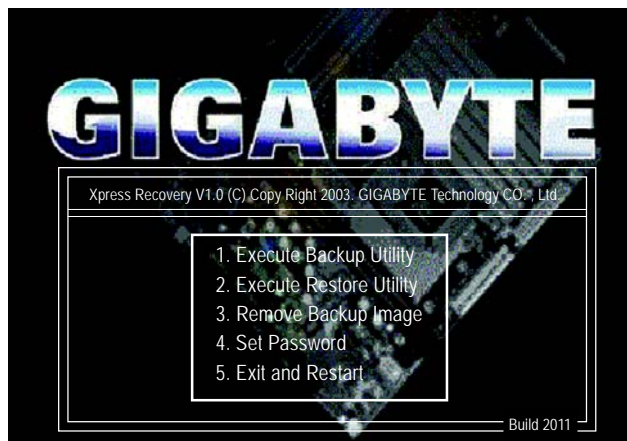

2. Press F9 during powering on the computer. (Text Mode)
Press F9 during powering on the computer .

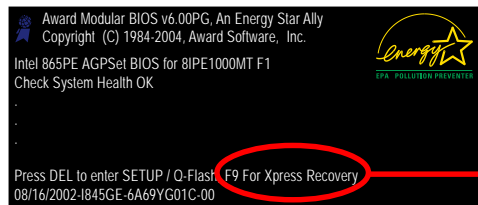

F9 For Xpress Recovery

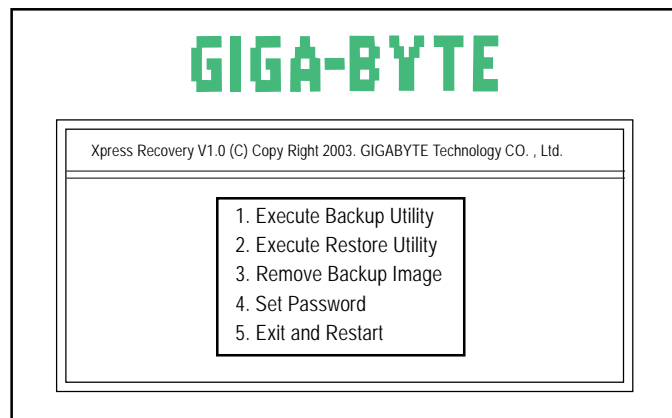

1. If you have already entered Xpress Recovery by booting from the CD-ROM, you can enter Xpress Recovery in the future by pressing the F9 key.
2. System storage capacity as well as drive reading/writing speed will affect backup speed.
3. It is recommended that Xpress Recovery be immediately installed after OS and all required driver and software installations are complete.

1. Execute Backup Utility:

 **Press B to Backup your System or Esc to Exit**

The backup utility will automatically scan your system and back up data as a backup image in your hard drive.



Not all systems support access to Xpress Recovery by pressing the F9 key during computer power on. If this is the case, please use the boot from CD-ROM method to enter Xpress Recovery.

2. Execute Restore Utility:

 **This program will recover your system to factory default.**

Press R to restore your system back to factory default or press Esc to exit

Restores backup image to original state.

3. Remove Backup Image:

 **Remove backup image. Are you sure? (Y/N)**

Remove the backup image.

4. Set Password:

 **Please input a 4-16 character long password (a-z or 0-9) or press Esc to exit**

You can set a password to enter Xpress Recovery to protect your hard disk data. Once this is done, password input will be required to enter Xpress Recovery during the next as well as subsequent system restarts. If you wish to remove the need for password entry, please select "Set Password" and under "New Password/Confirm Password", make sure there is no entry and then press "Enter" to remove password requirement.

5. Exit and Restart:

Exit and restart your computer.

4-1-3 Flash BIOS Method Introduction



Method 1 : Q-Flash™ Utility

Q-Flash™ is a BIOS flash utility embedded in Flash ROM. With this utility, users only have to stay in the BIOS menu when they want to update BIOS. Q-Flash™ allows users to flash BIOS without any utility in DOS or Windows. Using Q-Flash™ indicating no more fooling around with any complicated instructions and operating system since it is in the BIOS menu.



Please note that because updating BIOS has potential risk, please do it with caution!! We are sorry that Gigabyte Technology Co., Ltd is not responsible for damages of system because of incorrect manipulation of updating BIOS to avoid any claims from end-users.

Before You Begin:

Before you start updating BIOS with the Q-Flash™ utility, please follow the steps below first.

1. Download the latest BIOS for your motherboard from Gigabyte's website.
2. Extract the BIOS file downloaded and save the BIOS file (the one with model name.Fxx. For example, 8KNXPU.Fba) to a floppy disk.
3. Reboot your PC and press **Del** to enter BIOS menu.

The BIOS upgrading guides below are separated into two parts.

If your motherboard has dual-BIOS, please refer to **Part One**.

If your motherboard has single-BIOS, please refer to **Part Two**.

Part One:

Updating BIOS with Q-Flash™ Utility on Dual BIOS Motherboards.

Some of Gigabyte motherboards are equipped with dual BIOS. In the BIOS menu of the motherboards supporting Q-Flash and Dual BIOS, the Q-Flash utility and Dual BIOS utility are combined in the same screen. This section only deals with how to use Q-Flash utility.

In the following sections, we take GA-8KNXP Ultra as the example to guide you how to flash BIOS from an older version to the latest version. For example, from Fa3 to Fba.

The BIOS file is Fa3
before updating

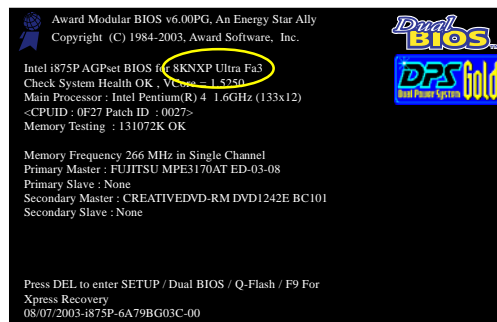

Entering the Q-Flash™ utility:

Step1: To use Q-Flash utility, you must press **Del** in the boot screen to enter BIOS menu.

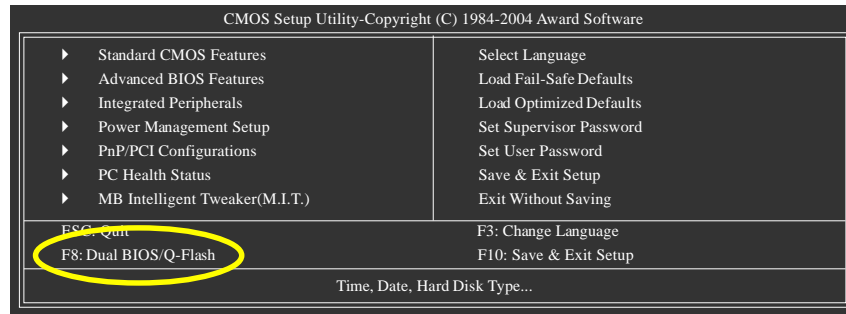

Step 2: Press **F8** button on your keyboard and then **Y** button to enter the Dual BIOS/Q-Flash utility.

Exploring the Q-Flash™ / Dual BIOS utility screen

The Q-Flash / Dual BIOS utility screen consists of the following key components.

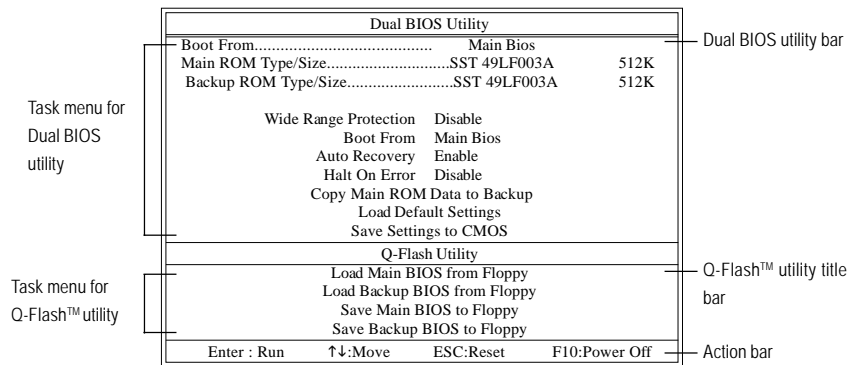

Task menu for Dual BIOS utility:

Contains the names of eight tasks and two item showing information about the BIOS ROM type. Blocking a task and pressing Enter key on your keyboard to enable execution of the task.

Task menu for Q-Flash utility:

Contains the names of four tasks. Blocking a task and pressing Enter key on your keyboard to enable execution of the task.

Action bar:

Contains the names of four actions needed to operate the Q-Flash/Dual BIOS utility. Pressing the buttons mentioned on your keyboards to perform these actions.

- Press Y button on your keyboard after you are sure to update BIOS.
Then it will begin to update BIOS. The progress of updating BIOS will be displayed.



Please do not take out the floppy disk when it begins flashing BIOS.

- Press any keys to return to the Q-Flash menu when the BIOS updating procedure is completed.

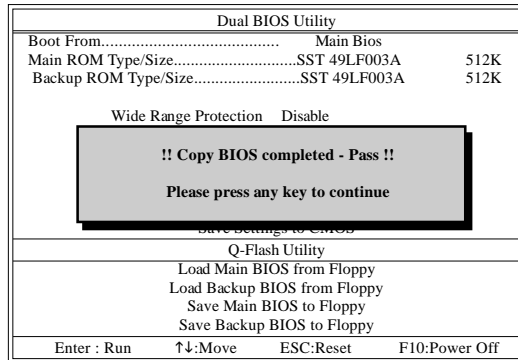

You can repeat Step 1 to 4 to flash the backup BIOS, too.

- Press Esc and then Y button to exit the Q-Flash utility. The computer will restart automatically after you exit Q-Flash.

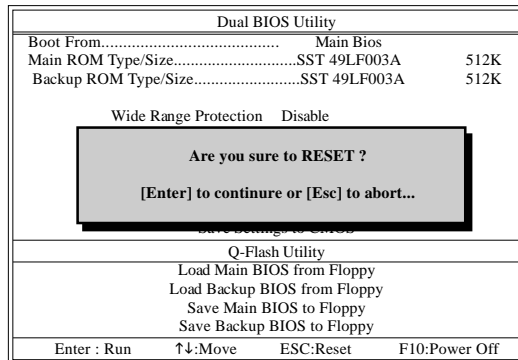

After system reboots, you may find the BIOS version on your boot screen becomes the one you flashed.

The BIOS file becomes Fab after updating.

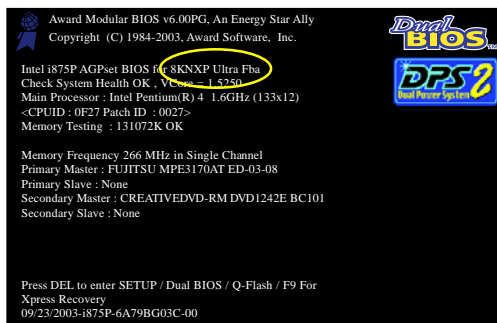

- 6. Press **Del** to enter BIOS menu after system reboots. When you are in BIOS menu, move to **Load Fail-Safe Defaults** item and press **Enter** to load BIOS Fail-Safe Defaults. Normally the system redetects all devices after BIOS has been upgraded. Therefore, we highly recommend reloading the BIOS defaults after BIOS has been upgraded.

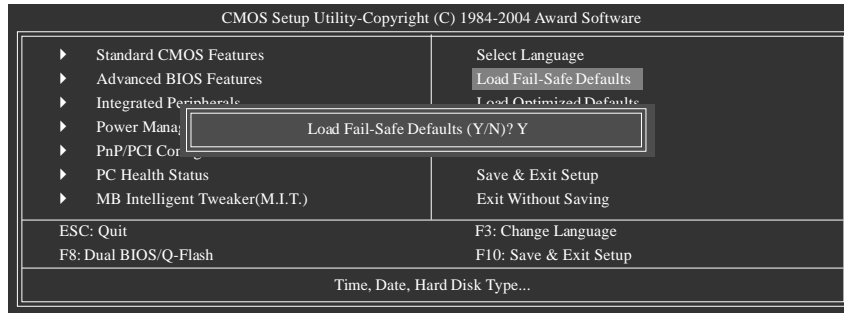

Press **Y** on your keyboard to load defaults.

- 7. Select **Save & Exit Setup** item to save the settings to CMOS and exit the BIOS menu. System will reboot after you exit the BIOS menu. The procedure is completed.

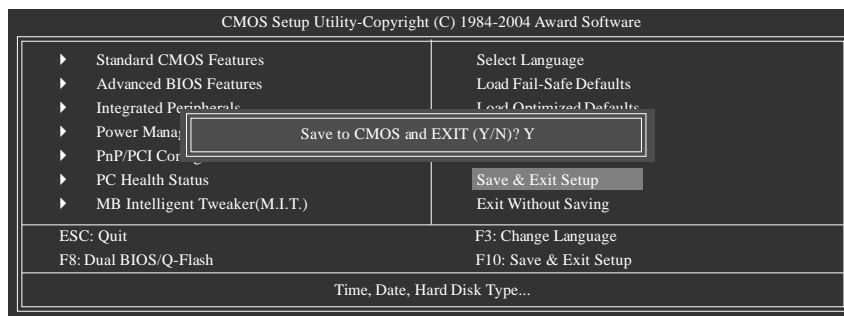

Press **Y** on your keyboard to save and exit.

Part Two:

Updating BIOS with Q-Flash™ Utility on Single-BIOS Motherboards.

This part guides users of single-BIOS motherboards how to update BIOS using the Q-Flash™ utility.

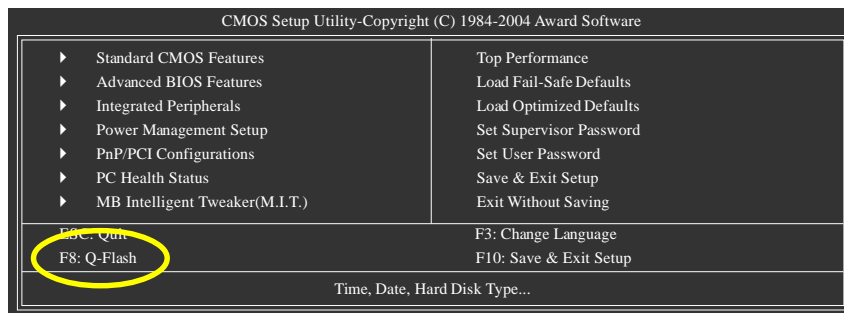

- Press Y button on your keyboard after you are sure to update BIOS.
Then it will begin to update BIOS. The progress of updating BIOS will be shown at the same time.

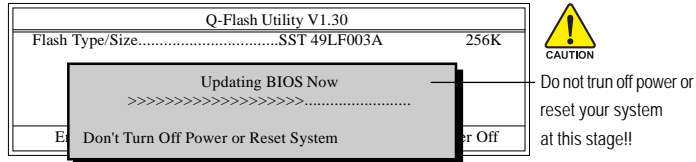

- Press any keys to return to the Q-Flash menu when the BIOS updating procedure is completed.

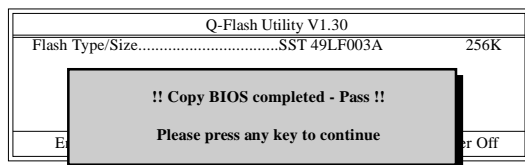

- Press Esc and then Y button to exit the Q-Flash utility. The computer will restart automatically after you exit Q-Flash.

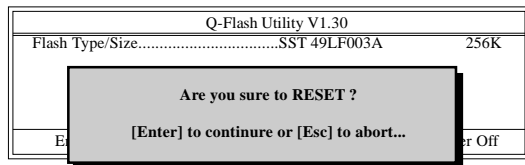

After system reboots, you may find the BIOS version on your boot screen becomes the one you flashed.

The BIOS file becomes F4 after updating

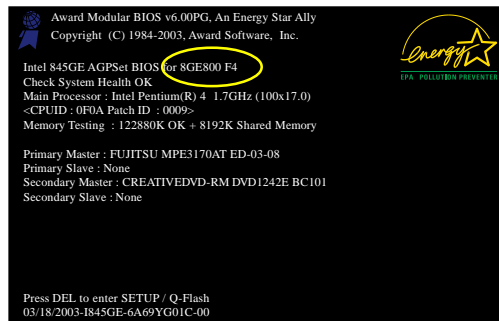

- Press Del to enter BIOS menu after system reboots and "Load BIOS Fail-Safe Defaults". See how to Load BIOS Fail-Safe Defaults, please kindly refer to Step 6 to 7 in Part One.

Congratulation!! You have updated BIOS successfully!!



Method 2 : @BIOS™ Utility

If you do not have a DOS startup disk, we recommend that you use the new @BIOS utility. @BIOS allows users to update their BIOS under Windows. Just select the desired @BIOS server to download the latest version of BIOS.

Fig 1. Installing the @BIOS utility

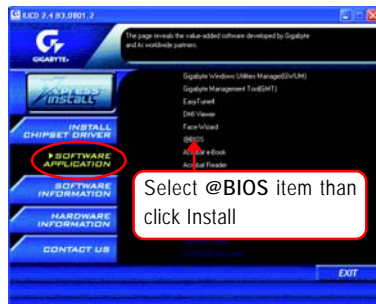
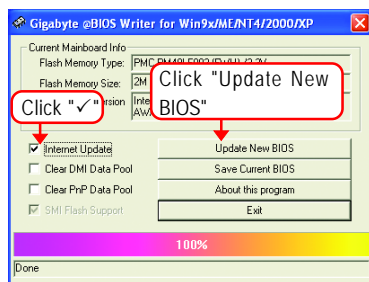

Fig 3. The @BIOS Utility



1. Methods and steps:

I. Update BIOS through Internet

- a. Click "Internet Update" icon
- b. Click "Update New BIOS" icon
- c. Select @BIOS™ sever
- d. Select the exact model name on your motherboard
- e. System will automatically download and update the BIOS.

II. Update BIOS NOT through Internet:

- a. Do not click "Internet Update" icon
- b. Click "Update New BIOS"
- c. Please select "All Files" in dialog box while opening the old file.
- d. Please search for BIOS unzip file, downloading from internet or any other methods (such as: 81845GV.E2).
- e. Complete update process following the instruction.

Fig 2. Installation Complete and Run @BIOS

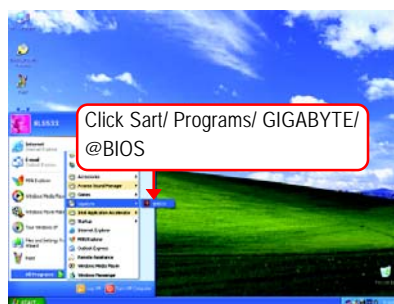

Fig 4. Select the desired @BIOS server



III. Save BIOS

In the very beginning, there is "Save Current BIOS" icon shown in dialog box. It means to save the current BIOS version.

IV. Check out supported motherboard and Flash ROM:

In the very beginning, there is "About this program" icon shown in dialog box. It can help you check out which kind of motherboard and which brand of Flash ROM are supported.

2. Note:

- I. In method I, if it shows two or more motherboard's model names to be selected, please make sure your motherboard's model name again. Selecting wrong model name will cause the system unbooted.
- II. In method II, be sure that motherboard's model name in BIOS unzip file are the same as your motherboard's. Otherwise, your system won't boot.
- III. In method I, if the BIOS file you need cannot be found in @BIOSTM server, please go onto Gigabyte's web site for downloading and updating it according to method II.
- IV. Please note that any interruption during updating will cause system unbooted

4-1-4 2- / 4- / 6- Channel Audio Function Introduction

This motherboard provide 6 audio connector. You are able to use 2-/4-/6-channels audio feature by audio software selection.

The installation of Windows 98SE/2K/ME/XP is very simple. Please follow next step to install the function!

Stereo Speakers Connection and Settings:

We recommend that you use the speaker with amplifier to acquire the best sound effect if the stereo output is applied.

STEP 1:
Connect the stereo speakers or earphone to "Line Out".

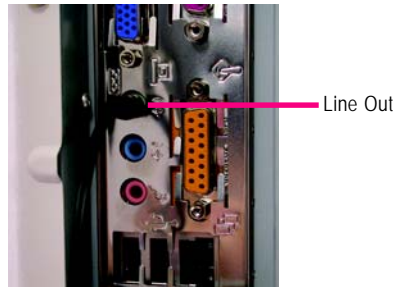

STEP 2 :
After installation of the audio driver, you'll find an  icon on the taskbar's status area. Click the audio icon "Sound Effect" from the windows tray at the bottom of the screen.

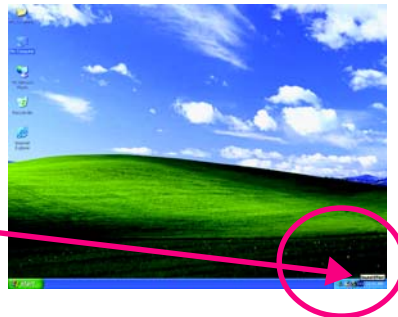

STEP 3:
Select "Speaker Configuration", and choose the "2 channels for stereo speakers out put".

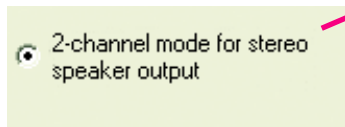

4 Channel Analog Audio Output Mode

STEP 1 :

Connect the front channels to "Line Out", the rear channels to "Line In".

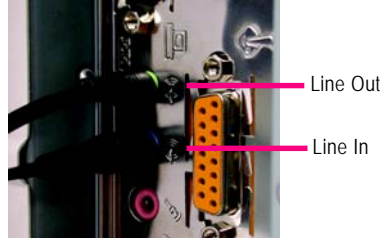

STEP 2 :

After installation of the audio driver, you'll find an  icon on the taskbar's status area. Click the audio icon "Sound Effect" from the windows tray at the bottom of the screen.

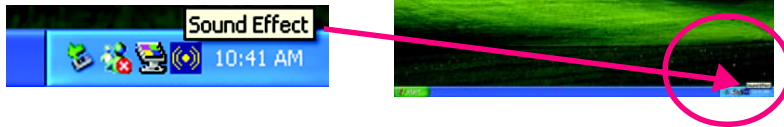

STEP 3 :

Select "Speaker Configuration", and choose the "4 channels for 4 speakers out put". Disable "Only SURROUND-KIT", and press "OK".

 4-channel mode for 4 speaker output



When the "Environment settings" is "None", the sound would be performed as stereo mode (2 channels output). Please select the other settings for 4 channels output.

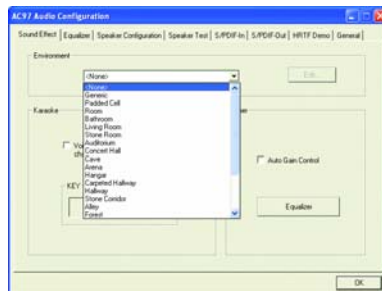

Basic 6 Channel Analog Audio Output Mode

Use the back audio panel to connect the audio output without any additional module.

STEP 1 :

Connect the front channels to "Line Out", the rear channels to "Line In", and the Center/Subwoofer channels to "MIC In".

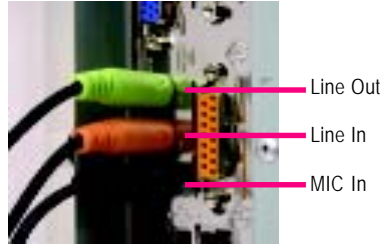

STEP 2 :

After installation of the audio driver, you'll find an  icon on the taskbar's status area. Click the audio icon "Sound Effect" from the windows tray at the bottom of the screen.

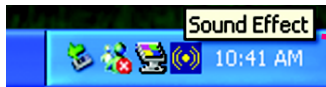

STEP 3 :

Select "Speaker Configuration", and choose the "6 channels for 5.1 speakers out put". Disable "Only SURROUND-KIT" and press "OK".

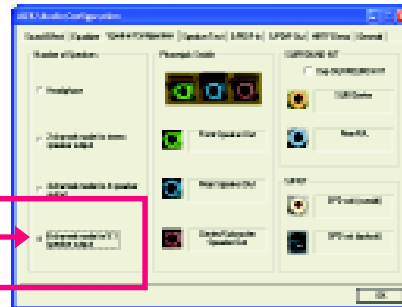
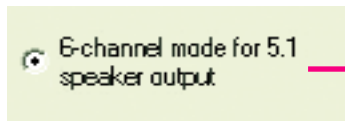

Advanced 6 Channel Analog Audio Output Mode (using Audio Combo Kit,Optional Device):
(Audio Combo Kit provides SPDIF output port : optical & coaxial and SURROUND-KIT : Rear R/L & Center/subwoofer)

SURROUND-KIT access analog output to rear channels and Center/Subwoofer channels. It is the best solution if you need 6 channel output, Line In and MIC at the same time. "SURROUND-KIT" is included in the GIGABYTE unique "Audio Combo Kit" as picture.



STEP 1 :
Insert the "Audio Combo Kit" in the back of the case,and fix it with the screw.



STEP 2 :
Connect the "SURROUND-KIT" to SUR_CEN on the M/B.

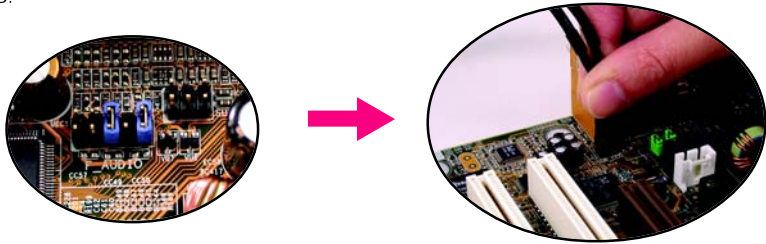

STEP 3 :

Connect the front channels to back audio panel's "Line Out", the rear channels to SURROUND-KIT's REAR R/L, and the Center/Subwoofer channels to SURROUND-KIT's SUB CENTER.

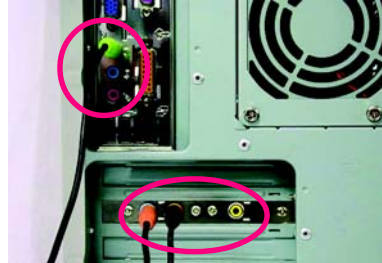

STEP 4 :

Click the audio icon "Sound Effect" from the windows tray at the bottom of the screen.

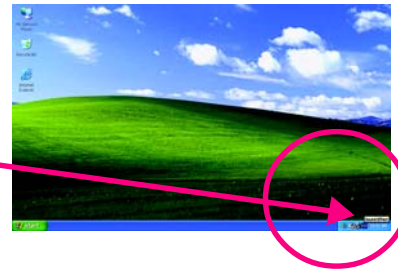

STEP 5 :

Select "Speaker Configuration", and choose the "6 channels for 5.1 speakers out put". Enable "Only SURROUND-KIT" and press "OK".

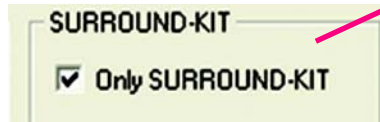

Basic & Advanced 6 Channel Analog Audio Output Mode Notes:

When the "Environment settings" is "None", the sound would be performed as stereo mode (2 channels output). Please select the other settings for 6 channels output.

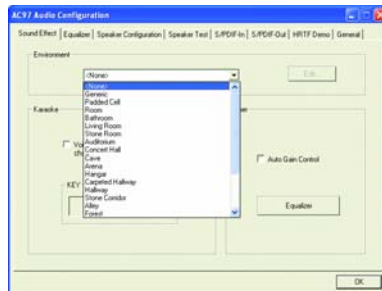

SPDIF Output Device (Optional Device)

A "S/PDIF output" connector is available on the motherboard. Cable with rear bracket is provided and could link to the "S/PDIF output" connector (As picture.) For the further linkage to decoder, rear bracket provides coaxial cable and Fiber connecting port.

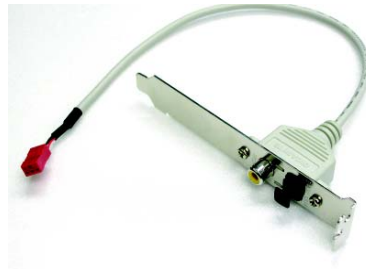

1. Connect the SPDIF output device to the rear bracket of PC, and fix it with screw.



2. Connect SPDIF wire to the motherboard.

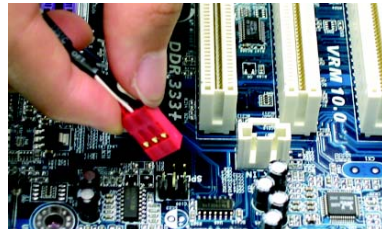

3. Connect co-axial or optical output to the AC3 decoder.



4-1-5 Jack-Sensing Introduction



Jack-Sensing provides audio connectors error-detection function.



Install Microsoft DirectX8.1 before to enable Jack-Sensing support for Windows 98/98SE/2000/ME.

Jack-Sensing includes 2 parts: AUTO and MANUAL. Following is an example for 2 channels (Windows XP):

Introduction of audio connectors

You may connect CDROM, Walkman or others audio input devices to Line In jack, speakers, earphone or others output devices to Line Out jack, and microphone to MIC In jack.

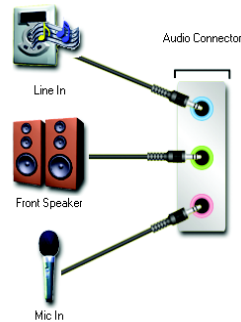

Auto-detecting:

Please connect the devices to the right jacks as above. A window will appear as right picture if you setup the devices properly.

Please note that 3D audio function will only appear when 3D audio inputs.



If you set wrong with the connectors, the warning message will come out as right picture.

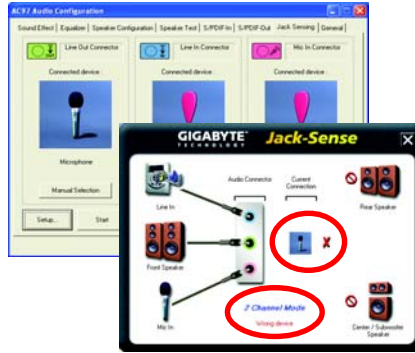

Manual setting:

If the device picture shows different from what you set, please press "Manual Selection" to set.



4-2 Troubleshooting

Below is a collection of general asked questions. To check general asked questions based on a specific motherboard model, please log on to <http://tw.giga-byte.com/faq/faq.htm>

Question 1: I cannot see some options that were included in previous BIOS after updating BIOS. Why?

Answer: Some advanced options are hidden in new BIOS version. Please press Ctrl and F1 keys after entering BIOS menu and you will be able to see these options.

Questions 2: Why is the light of my keyboard/optical mouse still on after computer shuts down?

Answer: In some boards, a small amount of electricity is kept on standby after computer shuts down and that's why the light is still on.

Question 3: How do I clear CMOS?

Answer: If your board has a Clear CMOS jumper, please refer to the Clear CMOS steps in the manual. If your board doesn't have such jumper, you can take off the on-board battery to leak voltage to clear CMOS.

Please refer to the steps below:

Steps:

1. Turn off power.
2. Disconnect the power cord from MB.
3. Take out the battery gently and put it aside for about 10 minutes (Or you can use a metal object to connect the positive and negative pins in the battery holder to makethem short for one minute).
4. Re-insert the battery to the battery holder.
5. Connect power cord to MB again and turn on power.
6. Press Del to enter BIOS and load Fail-Safe Defaults.
7. Save changes and reboot the system.

Question 4: Why does system seem unstable after updating BIOS?

Answer: Please remember to load Fail-Safe Defaults (Or Load BIOS Defaults) after flashing BIOS. However, if the system instability still remains, please clear CMOS to solve the problem.

Question 5: Why do I still get a weak sound after turning up the speaker to the maximum volume?

Answer: Please make sure the speaker you are using is equipped with an internal amplifier. If not, please change another speaker with power/amplifier and try again later.

Question 6: How do I disable onboard VGA card in order to add an external VGA card?

Answer: Gigabyte motherboards will auto-detect the external VGA card after it is plugged in, so you don't need to change any setting manually to disable the onboard VGA.

Question 7: Why cannot I use the IDE 2?

Answer: Please refer to the user manual and check whether you have connected any cable that is not provided with the motherboard package to the USB Over Current pin in the Front USB Panel. If the cable is your own cable, please remove it from this pin and do not connect any of your own cables to it.

Question 8: Sometimes I hear different continuous beeps from computer after system boots up. What do these beeps usually stand for?

Answer: The beep codes below may help you identify the possible computer problems. However, they are only for reference purposes. The situations might differ from case to case.

→AMI BIOS Beep Codes

*Computer gives 1 short beep when system boots successfully.

*Except for beep code 8, these codes are always fatal.

- 1 beep Refresh failure
- 2 beeps Parity error
- 3 beeps Base 64K memory failure
- 4 beeps Timer not operational
- 5 beeps Processor error
- 6 beeps 8042 - gate A20 failure
- 7 beeps Processor exception interrupt error
- 8 beeps Display memory read/write failure
- 9 beeps ROM checksum error
- 10 beeps CMOS shutdown register read/write error
- 11 beeps Cache memory bad

→ AWARD BIOS Beep Codes

- 1 short: System boots successfully
- 2 short: CMOS setting error
- 1 long 1 short: DRAM or M/B error
- 1 long 2 short: Monitor or display card error
- 1 long 3 short: Keyboard error
- 1 long 9 short: BIOS ROM error
- Continuous long beeps: DRAM error
- Continuous short beeps: Power error



Contact Us

- **Taiwan (Headquarters)**

GIGA-BYTE TECHNOLOGY CO., LTD.

Address: No.6, Bau Chiang Road, Hsin-Tien, Taipei Hsien, Taiwan

TEL: +886 (2) 8912-4888

FAX: +886 (2) 8912-4003

Tech. Support :

<http://tw.giga-byte.com/TechSupport/ServiceCenter.htm>

Non-Tech. Support(Sales/Marketing) :

<http://ggts.gigabyte.com.tw/nontech.asp>

WEB address (English): <http://www.gigabyte.com.tw>

WEB address (Chinese): <http://chinese.giga-byte.com>

- **U.S.A.**

G.B.T. INC.

Address: 17358 Railroad St, City of Industry, CA 91748.

TEL: +1 (626) 854-9338

FAX: +1 (626) 854-9339

Tech. Support :

<http://www.giga-byte.com/TechSupport/ServiceCenter.htm>

Non-Tech. Support(Sales/Marketing) :

<http://ggts.gigabyte.com.tw/nontech.asp>

WEB address : <http://www.giga-byte.com>

- **Germany**

G.B.T. TECHNOLOGY TRADING GMBH

Address: Friedrich-Ebert-Damm 112 22047 Hamburg

TEL: +49-40-2533040 (Sales)

+49-1803-428468 (Tech.)

FAX: +49-40-25492343 (Sales)

+49-1803-428329 (Tech.)

Tech. Support :

<http://de.giga-byte.com/TechSupport/ServiceCenter.htm>

Non-Tech. Support(Sales/Marketing) :

<http://ggts.gigabyte.com.tw/nontech.asp>

WEB address : <http://www.gigabyte.de>

- **Japan**

NIPPON GIGA-BYTE CORPORATION

WEB address : <http://www.gigabyte.co.jp>

- **Singapore**

GIGA-BYTE SINGAPORE PTE. LTD.

Tech. Support :

<http://tw.giga-byte.com/TechSupport/ServiceCenter.htm>

Non-Tech. Support(Sales/Marketing) :

<http://ggts.gigabyte.com.tw/nontech.asp>

- **U.K.**

G.B.T. TECH. CO., LTD.

Address: GUnit 13 Avant Business Centre 3 Third Avenue, Denbigh West Blechley Milton Keynes, MK1 1DR, UK, England

TEL: +44-1908-362700

FAX: +44-1908-362709

Tech. Support :

<http://uk.giga-byte.com/TechSupport/ServiceCenter.htm>

Non-Tech. Support(Sales/Marketing) :

<http://ggts.gigabyte.com.tw/nontech.asp>

WEB address : <http://uk.giga-byte.com>

- **The Netherlands**

GIGA-BYTE TECHNOLOGY B.V.

TEL: +31 40 290 2088

NL Tech.Support: 0900-GIGABYTE (0900-44422983)

BE Tech.Support: 0900-84034

FAX: +31 40 290 2089

Tech. Support :

<http://nz.giga-byte.com/TechSupport/ServiceCenter.htm>

Non-Tech. Support(Sales/Marketing) :

<http://ggts.gigabyte.com.tw/nontech.asp>

WEB address : <http://www.giga-byte.nl>

- **China**

NINGBO G.B.T. TECH. TRADING CO., LTD.

Tech. Support :

<http://cn.giga-byte.com/TechSupport/ServiceCenter.htm>

Non-Tech. Support(Sales/Marketing) :

<http://ggts.gigabyte.com.tw/nontech.asp>

WEB address : <http://www.gigabyte.com.cn>

Shanghai

TEL: +86-021-63410999

FAX: +86-021-63410100

Beijing

TEL: +86-010-82886651

FAX: +86-010-82888013

Wuhan

TEL: +86-027-87851061

FAX: +86-027-87851330

GuangZhou

TEL: +86-020-87586074

FAX: +86-020-85517843

Chengdu

TEL: +86-028-85236930

FAX: +86-028-85256822

Xian

TEL: +86-029-85531943

FAX: +86-029-85539821

Shenyang

TEL: +86-024-23960918

FAX: +86-024-23960918-809

- **Australia**

GIGABYTE TECHNOLOGY PTY. LTD.

Tech. Support :

<http://www.giga-byte.com.au/TechSupport/ServiceCenter.htm>

Non-Tech. Support(Sales/Marketing) :

<http://ggts.gigabyte.com.tw/nontech.asp>

WEB address : <http://www.giga-byte.com.au>

- **France**

GIGABYTE TECHNOLOGY FRANCES S.A.R.L.

Tech. Support :

<http://tw.giga-byte.com/TechSupport/ServiceCenter.htm>

Non-Tech. Support(Sales/Marketing) :

<http://ggts.gigabyte.com.tw/nontech.asp>

WEB address : <http://www.gigabyte.fr>

- **Russia**

Moscow Representative Office Of Giga-Byte Technology Co., Ltd.

Tech. Support :

<http://tw.giga-byte.com/TechSupport/ServiceCenter.htm>

Non-Tech. Support(Sales/Marketing) :

<http://ggts.gigabyte.com.tw/nontech.asp>

WEB address : <http://www.gigabyte.ru>

- **Poland**

Representative Office Of Giga-Byte Technology Co., Ltd.

POLAND

Tech. Support :

<http://tw.giga-byte.com/TechSupport/ServiceCenter.htm>

Non-Tech. Support(Sales/Marketing) :

<http://ggts.gigabyte.com.tw/nontech.asp>

WEB address : <http://www.gigabyte.pl>
