

# **CENTRAL MACHINERY<sup>®</sup>**

# **1HP MINI DUST COLLECTOR**

**Model 94029**

## **ASSEMBLY AND OPERATING INSTRUCTIONS**



3491 Mission Oaks Blvd., Camarillo, CA 93011  
Visit our Web site at: <http://www.harborfreight.com>

**TO PREVENT SERIOUS INJURY,  
READ AND UNDERSTAND ALL WARNINGS  
AND INSTRUCTIONS BEFORE USE.**

Copyright© 2005 by Harbor Freight Tools®. All rights reserved. No portion of this manual or any artwork contained herein may be reproduced in any shape or form without the express written consent of Harbor Freight Tools.

**For technical questions or replacement parts, please call 1-800-444-3353.**

## PRODUCT SPECIFICATIONS

Item	Description
Electrical Requirements	120V / 60 Hz / 750 Watts / 1HP Single Phase 3 Prong Power Plug 6'-5" Power Cord Length Power Switch Safety Key Feature Easy Access Carbon Brushes (Qty. 2)
Inlet/Outlet Dimensions	4" Diameter
Collector Bag Particle Filtration Capacity	35 Micron
Collector Bag Holding Capacity	12 Gallons
CFM Capacity	914 CFM
Sound Rating	107~112 dB @ 3 Feet
Overall Dimensions	13-1/4" x 12" x 12"
Unit Weight	18-1/2 Pounds

## SAVE THIS MANUAL

You will need this manual for the safety warnings and precautions, assembly, operating, inspection, maintenance and cleaning procedures, parts list and assembly diagram. Keep your invoice with this manual. Write the invoice number on the inside of the front cover. Keep this manual and invoice in a safe and dry place for future reference.

## GENERAL SAFETY RULES

 **WARNING!**

**READ AND UNDERSTAND ALL INSTRUCTIONS**  
Failure to follow all instructions listed in the following pages may result in electric shock, fire, and/or serious injury.

**SAVE THESE INSTRUCTIONS**

### WORK AREA

1. **Keep your work area clean and well lit.** Cluttered benches and dark areas invite accidents.
2. **Do not operate power tools in explosive atmospheres, such as in the**

**presence of flammable liquids, gases, or dust.** Power tools create sparks which may ignite flammables.

3. **Keep bystanders, children, and visitors away while operating a power tool.** Distractions can cause you to lose control. Protect others in the work area from debris such as chips and sparks. Provide barriers or shields as needed.

## ELECTRICAL SAFETY

4. **Grounded tools must be plugged into an outlet properly installed and grounded in accordance with all codes and ordinances. Never remove the grounding prong or modify the plug in any way. Do not use any adapter plugs. Check with a qualified electrician if you are in doubt as to whether the outlet is properly grounded.** If the tools should electrically malfunction or break down, grounding provides a low resistance path to carry electricity away from the user.
5. **Double insulated tools are equipped with a polarized plug (one blade is wider than the other). This plug will fit in a polarized outlet only one way. If the plug does not fit fully in the outlet, reverse the plug. If it still does not fit, contact a qualified electrician to install a polarized outlet. Do not change the plug in any way.** Double insulation  eliminates the need for the three wire grounded power cord and grounded power supply system.
6. **Avoid body contact with grounded surfaces such as pipes, radiators, ranges, and refrigerators.** There is an increased risk of electric shock if your body is grounded.
7. **Do not expose power tools to rain or wet conditions.** Water entering a power tool will increase the risk of electric shock.
8. **Do not abuse the Power Cord. Never use the Power Cord to carry the tools or pull the Plug from an outlet. Keep the Power Cord away from heat, oil, sharp edges, or moving parts. Replace damaged Power Cords immediately.** Damaged Power Cords increase the risk of electric shock.
9. **When operating a power tool outside, use an outdoor extension cord marked “W-A” or “W”.** These extension cords are rated for outdoor use, and reduce the risk of electric shock.

## PERSONAL SAFETY

10. **Stay alert. Watch what you are doing, and use common sense when oper-**

**ating a power tool. Do not use a power tool while tired or under the influence of drugs, alcohol, or medication.** A moment of inattention while operating power tools may result in serious personal injury.

11. **Dress properly. Do not wear loose clothing or jewelry. Contain long hair. Keep your hair, clothing, and gloves away from moving parts.** Loose clothes, jewelry, or long hair can be caught in moving parts.
12. **Avoid accidental starting. Be sure the Power Switch is off before plugging in.** Carrying power tools with your finger on the Power Switch, or plugging in power tools with the Power Switch on, invites accidents.
13. **Remove adjusting keys or wrenches before turning the power tool on.** A wrench or a key that is left attached to a rotating part of the power tool may result in personal injury.
14. **Do not overreach. Keep proper footing and balance at all times.** Proper footing and balance enables better control of the power tool in unexpected situations.
15. **Use safety equipment. Always wear eye protection.** Dust mask, nonskid safety shoes, hard hat, or hearing protection must be used for appropriate conditions.

#### TOOL USE AND CARE



16. **Use clamps (not included) or other practical ways to secure and support the workpiece to a stable platform.** Holding the work by hand or against your body is unstable and may lead to loss of control.
17. **Do not force the tool. Use the correct tool for your application.** The correct tool will do the job better and safer at the rate for which it is designed.
18. **Do not use the power tool if the Power Switch does not turn it on or off.** Any tool that cannot be controlled with the Power Switch is dangerous and must be replaced.
19. **Disconnect the Power Cord Plug from the power source before making any adjustments, changing accessories, or storing the tool.** Such preventive safety measures reduce the risk of starting the tool accidentally.
20. **Store idle tools out of reach of children and other untrained persons.** Tools are dangerous in the hands of untrained users.



21. **Maintain tools with care. Keep cutting tools sharp and clean.** Properly maintained tools with a sharp cutting edge are less likely to bind and are easier to control. Do not use a damaged tool. Tag damaged tools “Do not use” until repaired.
22. **Check for misalignment or binding of moving parts, breakage of parts, and any other condition that may affect the tool’s operation. If damaged, have the tool serviced before using.** Many accidents are caused by poorly maintained tools.
23. **Use only accessories that are recommended by the manufacturer for your model.** Accessories that may be suitable for one tool may become hazardous when used on another tool.

### SERVICE

24. **Tool service must be performed only by qualified repair personnel.** Service or maintenance performed by unqualified personnel could result in a risk of injury.
25. **When servicing a tool, use only identical replacement parts. Follow instructions in the “*Inspection, Maintenance, And Cleaning*” section of this manual.** Use of unauthorized parts or failure to follow maintenance instructions may create a risk of electric shock or injury.

## SPECIFIC SAFETY RULES

1. **Always wear ANSI-approved safety impact eye goggles, hearing protection, and a dust mask or respirator when operating this product.**
2. **The sound rating for this product is 107-112 dB. The operator should always wear ANSI-approved hearing protection when using this product.**
3.  **WARNING!** The Collector Body (27) of this product contains a high speed Impeller (20) that can amputate fingers, grab loose clothing and long hair, and propel sawdust at high velocities. **NEVER** operate this product without the Inlet Cover (25), Safety Screen (26), and all other parts in place and working properly. **(See Assy. Diagram.)**
4.  **CAUTION!** If using this product to help keep airborne sawdust within acceptable limits, you must regularly monitor airborne sawdust and maintain the Dust Collection system to avoid exceeding dust limits. Each application is unique, and your maintenance schedule must be tailored to your specific use of the Dust Collector.

5. **Industrial applications must follow OSHA requirements.**
6. **Use the right tool or attachment for the right job.** Do not attempt to force a small tool or attachment to do the work of a larger industrial tool. There are certain applications for which this product was designed. It will do the job better and more safely at the rate for which it was intended. Do not modify this product, and do not use this product for a purpose for which it was not intended.
7. **Always turn off the Dust Collector and unplug the Power Cord Plug (1) from its electrical outlet before changing accessories or performing inspection, maintenance, or cleaning procedures.**
8.  **WARNING!** People with pacemakers should consult their physician(s) before using this product. Operation of electrical equipment in close proximity to a heart pacemaker could cause interference or failure of the pacemaker.
9.  **WARNING!** Some dust created by power sanding, sawing, grinding, drilling, and other construction activities, contain chemicals known (to the State of California) to cause cancer, birth defects or other reproductive harm. Some examples of these chemicals are: lead from lead-based paints, crystalline silica from bricks and cement or other masonry products, arsenic and chromium from chemically treated lumber. Your risk from these exposures varies, depending on how often you do this type of work. To reduce your exposure to these chemicals: work in a well ventilated area, and work with approved safety equipment, such as those dust masks that are specially designed to filter out microscopic particles. *(California Health & Safety Code 25249.5, et seq.)*
10.  **WARNING!** The warnings, precautions, and instructions discussed in this manual cannot cover all possible conditions and situations that may occur. The operator must understand that common sense and caution are factors which cannot be built into this product, but must be supplied by the operator.
11. **Maintain labels and nameplates on the Dust Collector.** These carry important information. If unreadable or missing, contact Harbor Freight Tools for a replacement.

### SAVE THESE INSTRUCTIONS

#### GROUNDING

#### WARNING!

**Improperly connecting the grounding wire can result in the risk of electric shock. Check with a qualified electrician if you are in doubt as to whether the**

outlet is properly grounded. Do not modify the power cord plug provided with the tool. Never remove the grounding prong from the plug. Do not use the tool if the power cord or plug is damaged. If damaged, have it repaired by a service facility before use. If the plug will not fit the outlet, have a proper outlet installed by a qualified electrician.

### GROUNDING TOOLS: TOOLS WITH THREE PRONG PLUGS

1. Tools and equipment marked with “Grounding Required” have a three wire cord and three prong grounding plug. The plug must be connected to a properly grounded outlet. If the tool or equipment should electrically malfunction or break down, grounding provides a low resistance path to carry electricity away from the user, reducing the risk of electric shock. **(See Figure A.)**
2. The grounding prong in the plug is connected through the green wire inside the cord to the grounding system in the tool. The green wire in the cord must be the only wire connected to the tool’s grounding system and must never be attached to an electrically “live” terminal. **(See Figure A.)**
3. Your tool must be plugged into an appropriate outlet, properly installed and grounded in accordance with all codes and ordinances. The plug and outlet should look like that in the following illustration. **(See Figure A.)**

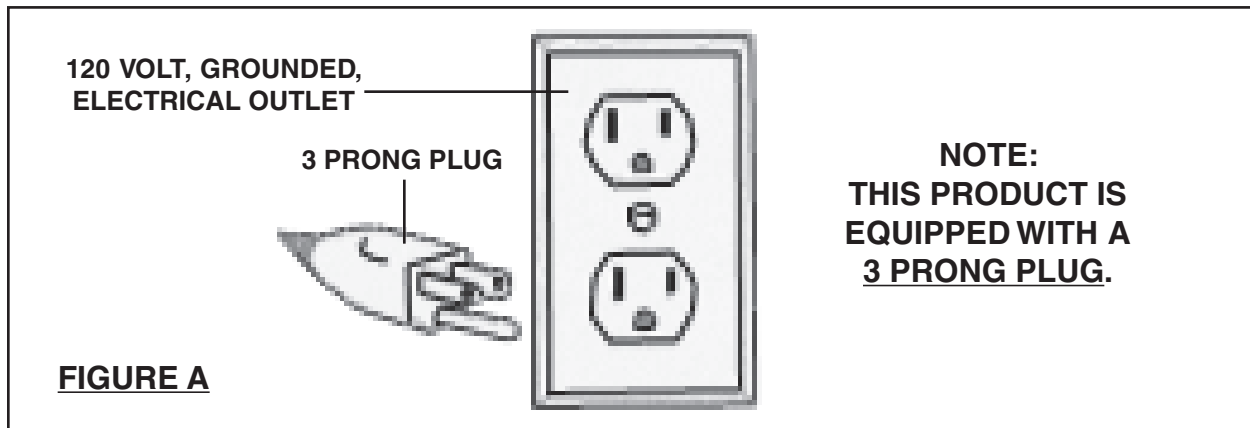

### DOUBLE INSULATED TOOLS: TOOLS WITH TWO PRONG PLUGS

1. Tools marked “Double Insulated” do not require grounding. They have a special double insulation system which satisfies OSHA requirements and complies with

the applicable standards of Underwriters Laboratories, Inc., the Canadian Standard Association, and the National Electrical Code. **(See Figure B.)**

2. Double insulated tools may be used in either of the 120 volt outlets shown in the following illustration. **(See Figure B.)**

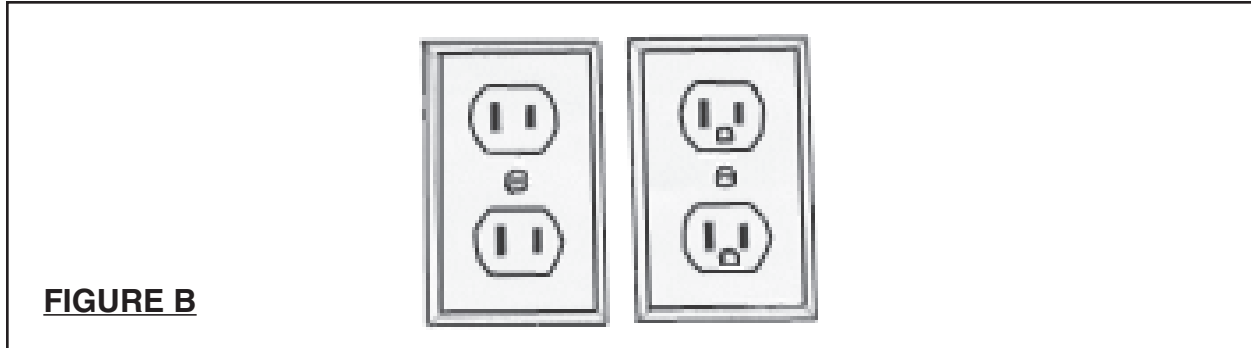

### EXTENSION CORDS

1. **Grounded** tools require a three wire extension cord. **Double Insulated** tools can use either a two or three wire extension cord.
2. As the distance from the supply outlet increases, you must use a heavier gauge extension cord. Using extension cords with inadequately sized wire causes a serious drop in voltage, resulting in loss of power and possible tool damage. **(See Figure C, next page.)**
3. The smaller the gauge number of the wire, the greater the capacity of the cord. For example, a 14 gauge cord can carry a higher current than a 16 gauge cord. **(See Figure C.)**
4. When using more than one extension cord to make up the total length, make sure each cord contains at least the minimum wire size required. **(See Figure C.)**
5. If you are using one extension cord for more than one tool, add the nameplate amperes and use the sum to determine the required minimum cord size. **(See Figure C.)**
6. If you are using an extension cord outdoors, make sure it is marked with the suffix "W-A" ("W" in Canada) to indicate it is acceptable for outdoor use.
7. Make sure your extension cord is properly wired and in good electrical condition. Always replace a damaged extension cord or have it repaired by a qualified



electrician before using it.



8. Protect your extension cords from sharp objects, excessive heat, and damp or wet areas.

<b>RECOMMENDED MINIMUM WIRE GAUGE FOR EXTENSION CORDS*</b> (120 VOLT)					
<b>NAMEPLATE AMPERES (At Full Load)</b>	<b>EXTENSION CORD LENGTH</b>				
	<b>25 FEET</b>	<b>50 FEET</b>	<b>75 FEET</b>	<b>100 FEET</b>	<b>150 FEET</b>
<b>0-2.0</b>	<b>18</b>	<b>18</b>	<b>18</b>	<b>18</b>	<b>16</b>
<b>2.1-3.4</b>	<b>18</b>	<b>18</b>	<b>18</b>	<b>16</b>	<b>14</b>
<b>3.5-5.0</b>	<b>18</b>	<b>18</b>	<b>16</b>	<b>14</b>	<b>12</b>
<b>5.1-7.0</b>	<b>18</b>	<b>16</b>	<b>14</b>	<b>12</b>	<b>12</b>
<b>7.1-12.0</b>	<b>18</b>	<b>14</b>	<b>12</b>	<b>10</b>	<b>-</b>
<b>12.1-16.0</b>	<b>14</b>	<b>12</b>	<b>10</b>	<b>-</b>	<b>-</b>
<b>16.1-20.0</b>	<b>12</b>	<b>10</b>	<b>-</b>	<b>-</b>	<b>-</b>

**\*Based on limiting the line voltage drop to five volts at 150% of the rated amperes.**

**FIGURE C**

## SYMBOLOLOGY

	<b>Double Insulated</b>
	<b>Underwriters Laboratories, Inc.</b>
	<b>Canadian Standards Association</b>
<b>V ~</b>	<b>Volts Alternating Current</b>
<b>A</b>	<b>Amperes</b>
<b>no xxxx/min.</b>	<b>No Load Revolutions Per Minute (RPM)</b>

**FIGURE D**

## UNPACKING

When unpacking, check to make sure all that all the parts listed in the **Parts List on page 13** are included. If any parts are missing or broken, please call Harbor Freight Tools at the phone number shown on the front cover of this manual as soon as possible.

## ASSEMBLY INSTRUCTIONS

### NOTE:

For additional information regarding the parts mentioned in the following pages, refer to the **Assembly Diagram on page 14**.

### **To Attach The Four Casters To The Machine Base:**

1. To attach the *four* Casters (39) to the Machine Base (41), place a Lock Washer (37) onto the threaded portion of each Caster. **(See Assy. Diagram.)**
2. Insert the threaded portion of each Caster (39) upward through the four mounting holes in the Machine Base (41). Then secure each Caster to the Machine Base, using four Lock Washers (37) and four Cap Nuts (36). **(See Assy. Diagram.)**

### **To Attach The Collector Bag To The Collector Body:**

To attach the Collector Bag (23) to the Collector Body (27), slide the opening of the Collector Bag over the opening of the Collector Body. Then secure the Collector Bag to the Collector Body, using the Clamp (24). **(See Assy. Diagram.)**

### **To Attach An Inlet Hose To The Collector Body:**

The Dust Collector is designed for use on *one* machine at a time, depending on the sawdust output of a particular machine. The Inlet Cover (25) of the Dust Collector can be connected to a machine using a *4" inside diameter* flex hose and a clamp (available at most local hardware retail outlets). The Dust Collector can also be used as a portable vacuum to clean the shop area with a *4" inside diameter* flex hose and *vacuum attachment* (neither included). **(See Figure E, next page.)**

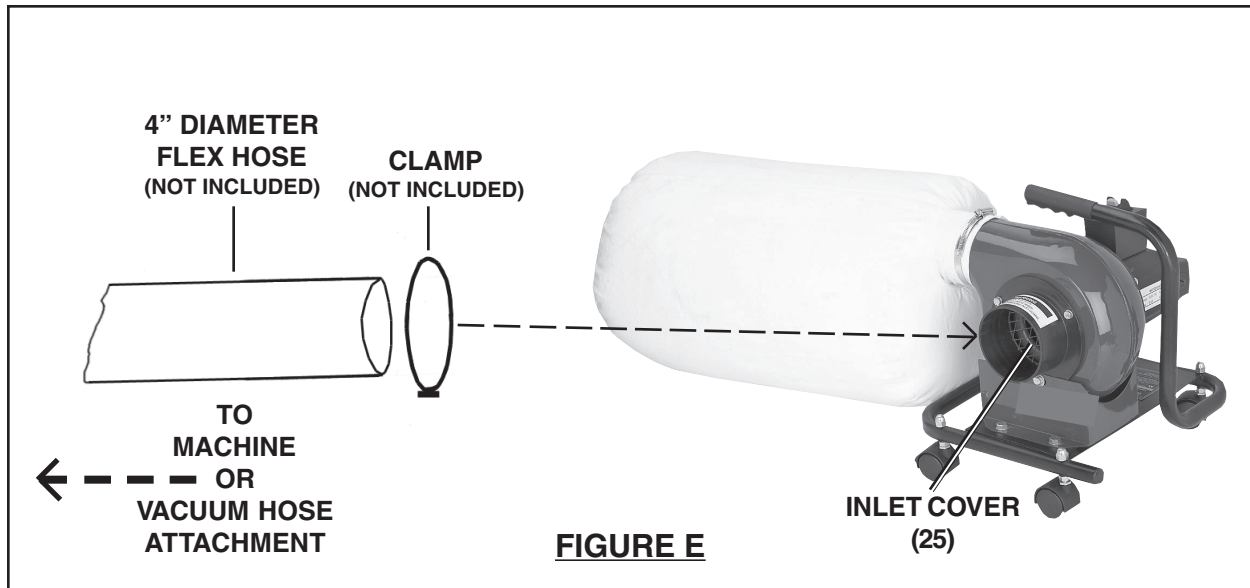

## OPERATING INSTRUCTIONS

### NOTE:

For additional information regarding the parts mentioned in the following pages, refer to the **Assembly Diagram on page 14.**

1. **NOTE:** The Power Switch is equipped with a Safety Key (7) to prohibit unauthorized starting of the Dust Collector. The Safety Key must be fully inserted into the Power Switch in order to turn the Power Switch to its “ON” position. When finished using the Dust Collector, turn the Power Switch to its “OFF” position. Remove the Safety Key, and store it in a safe location out of reach of children and unauthorized users. **(See Figure F, next page.)**
2. Insert the Safety Key (7) into the Power Switch (8), and check to make sure the Power Switch is in its “OFF” position. Then, plug the Power Cord Plug (1) into the nearest 120 volt, grounded, electrical outlet. **(See Figure F.)**
3. If the Dust Collector is connected to a machine, turn the Power Switch (8) of the Dust Collector to its “ON” position. Then, turn on the machine. If the Dust Collector is connected to a floor sweep accessory, hold the floor sweep accessory firmly to keep it from “whiplashing”. Then, turn the Power Switch of the Dust Collector to its “ON” position. **(See Figure F.)**
4. When finished using the Dust Collector, turn the Power Switch (8) to its “OFF” position, and remove the Safety Key (7) from the Power Switch. Unplug the

Power Cord Plug (1) from its electrical outlet. Then store the Dust Collector in a safe, clean, dry location out of reach of children and unauthorized users.

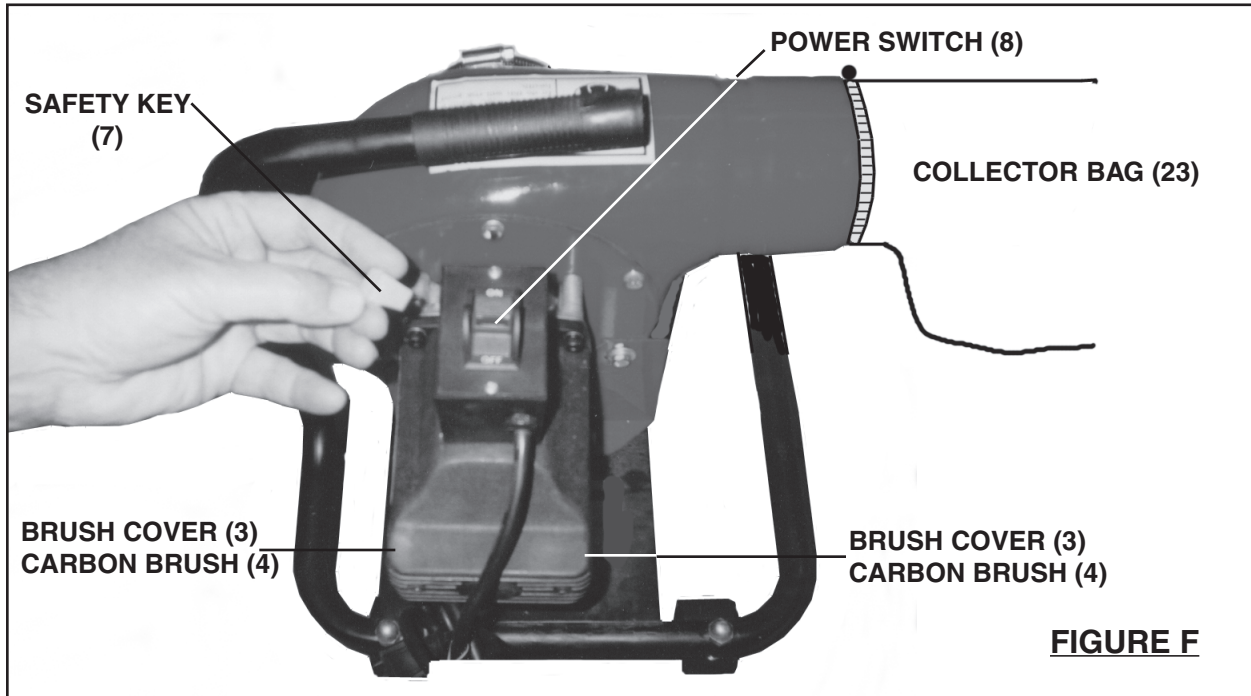

**FIGURE F**

## INSPECTION, MAINTENANCE, AND CLEANING

1.  **WARNING!** Always make sure the Power Switch (8) is in its “OFF” position, and unplug the Power Cord/Plug (1) from its 120 volt electrical outlet before performing any inspection, adjustments, maintenance, or cleaning.
2. **Before each use**, inspect the general condition of the Dust Collector. Check for loose screws, misalignment or binding of moving parts, cracked or broken parts, damaged electrical wiring, and any other condition that may affect its safe operation. If abnormal noise or vibration occurs, have the problem corrected before further use.  
**Do not use damaged equipment.**
3. **Daily:** With a soft brush, cloth, or vacuum, remove all dust and debris from the exterior of the Dust Collector. Then
4. **To replace the Carbon Brushes:** It may become necessary at sometime to replace the *two* Carbon Brushes (4) when the Motor performance decreases, or

stops working completely. **The Carbon Brushes are located on each side of the Motor Housing.** To do so, remove the two Brush Covers (3). Then, remove the two Carbon Brushes. If the Carbon Brushes are worn down more than 1/2, replace *both* Carbon Brushes. If, however, the Carbon Brushes are just dirty they may be cleaned by rubbing them with a pencil eraser. When installing the Carbon Brushes, make sure the carbon portion of the Carbon Brushes contact the Motor Armature, and that the springs face away from the Motor. Also, make sure the springs operate freely. After cleaning or replacement, replace the Brush Covers. **NOTE:** New Carbon Brushes tend to arc or spark when first used *until* they wear and conform to the Motor's Armature. (See Figure F, previous page.)

5.  **CAUTION!** All maintenance, service, or repairs not listed in this manual are only to be attempted by a qualified service technician.

**PLEASE READ THE FOLLOWING CAREFULLY**

THE MANUFACTURER AND/OR DISTRIBUTOR HAS PROVIDED THE PARTS LIST AND ASSEMBLY DIAGRAM IN THIS MANUAL AS A REFERENCE TOOL ONLY. NEITHER THE MANUFACTURER OR DISTRIBUTOR MAKES ANY REPRESENTATION OR WARRANTY OF ANY KIND TO THE BUYER THAT HE OR SHE IS QUALIFIED TO MAKE ANY REPAIRS TO THE PRODUCT, OR THAT HE OR SHE IS QUALIFIED TO REPLACE ANY PARTS OF THE PRODUCT. IN FACT, THE MANUFACTURER AND/OR DISTRIBUTOR EXPRESSLY STATES THAT ALL REPAIRS AND PARTS REPLACEMENTS SHOULD BE UNDERTAKEN BY CERTIFIED AND LICENSED TECHNICIANS, AND NOT BY THE BUYER. THE BUYER ASSUMES ALL RISK AND LIABILITY ARISING OUT OF HIS OR HER REPAIRS TO THE ORIGINAL PRODUCT OR REPLACEMENT PARTS THERETO, OR ARISING OUT OF HIS OR HER INSTALLATION OF REPLACEMENT PARTS THERETO.

**PARTS LIST**

Part #	Description	Qty.	Part #	Description	Qty.
1	Power Cord	1	23	Collector Bag	1
2	Cord Clamp	1	24	Clamp	1
3	Brush Cover	2	25	Inlet Cover	1
4	Carbon Brush	2	26	Safety Screen	1
5	Washer	1	27	Collector Body	1
6	Screw	1	28	Screw	9
7	Safety Key	1	29	Lock Washer	9
8	Power Switch	1	30	Hex Bolt	4
9	Screw	2	31	Lock Washer	4
10	Flat Washer	2	32	Machine Mounting Bracket	1
11	Switch Cover Plate	1	33	Hex Nut	4
12	Motor Mounting Bracket	1	34	Flat Washer	8
13	Shaft Key	1	35	Handle	1
14	Ground Conductor Cover	1	36	Cap Nut	4
15	Hex Screw	4	37	Lock Washer	8
16	Lock Washer	4	38	Hex Nut	4
17	Gasket	1	39	Caster	4
18	Collector Cover	1	40	End Cap	1
19	Gasket	1	41	Machine Base	1
20	Impeller	1			
21	Washer	1			
22	Hex Nut	1			

# ASSEMBLY DIAGRAM

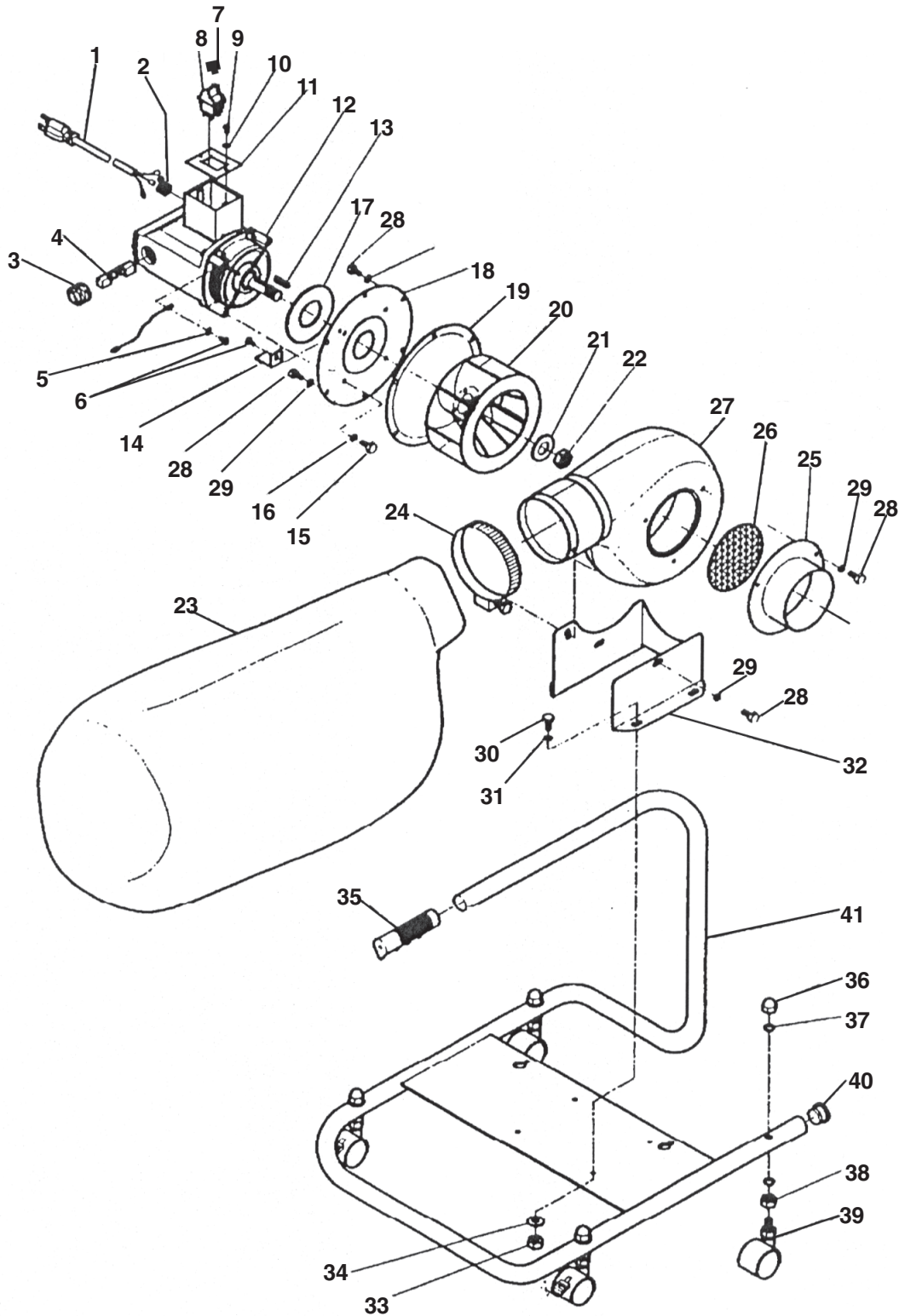

**NOTE:**

Some parts are listed and shown for illustration purposes only, and are not available individually as replacement parts.