

**8825/ 8830/ 8850/ 6030/ 6050/
510 Series / 721P/ 6204
WIDE FORMAT COPY SYSTEM**

User

Guide



Prepared by:

Xerox Corporation

Global Knowledge and Language Services

800 Phillips Road 845-17S

Webster, New York 14580

©2006 by Xerox Corporation. All rights reserved.

Copyright protection claimed includes all forms and matters of copyrightable material and information now allowed by statutory judicial law or hereinafter granted, including without limitation, material generated from the software programs which are displayed on the screen such as icons, screen displays, looks, etc.

Printed in the United States of America.

XEROX® and all Xerox product names mentioned in this publication are trademarks of XEROX CORPORATION.

One or more of the fonts listed within this document may be a registered trademark of Morisawa & Company, Ltd. or DYNALAB, Inc.

Changes are periodically made to this document. Changes, technical inaccuracies, and typographic errors will be corrected in subsequent editions.

Table of Contents

SAFETY NOTES.....	VII
WARNING – ELECTRICAL SAFETY INFORMATION.....	IX
OPERATIONAL SAFETY INFORMATION.....	X
MAINTENANCE INFORMATION.....	XI
OZONE SAFETY INFORMATION.....	XI
FOR CONSUMABLES.....	XI
RADIO FREQUENCY EMISSIONS.....	XII
<i>United States, Canada, Europe, Australia/New Zealand:</i>	<i>xii</i>
PRODUCT SAFETY CERTIFICATION.....	XII
REGULATORY INFORMATION.....	XII
ENVIRONMENTAL COMPLIANCE.....	XIII
GETTING TO KNOW THE WIDE FORMAT COPY SYSTEM.....	1
FEATURE KEYS.....	2
SCAN SYSTEM STANDARD COMPONENTS.....	3
SCAN SYSTEM COMPACT COMPONENTS.....	7
SCAN SYSTEM CONTROL PANEL.....	8
<i>Media Selection</i>	9
<i>Image Quality Area</i>	13
<i>Background Suppression</i>	16
<i>Copy</i>	17
<i>Reduce/Enlarge</i>	18
<i>Graphical Display and Navigation Keys</i>	20
<i>Numeric Keypad and Special Features/Control Keys</i>	22
<i>Special Features Keys</i>	23
<i>Scan Control Keys</i>	23
THE PRINTER AND THE FREEFLOW ACCXES CONTROLLER.....	23
POWERING ON THE WIDE FORMAT COPY SYSTEM.....	24
<i>Initial power-on</i>	24
<i>Switching on the Scan System</i>	24
<i>Switching on the Controller and the Printer (XEROX WIDE FORMAT</i> <i>COPY SYSTEM 8825/8830/8850)</i>	25
CONTROLLER POWER SWITCHES.....	26
<i>Switching on the PUN or YKE Controller and the Printer (XEROX WIDE</i> <i>FORMAT 8825/8830/8850/510 Series/721P)</i>	26
<i>Switching on the Printer and the Controller (PUN, YKE, and YKE-N</i> <i>controllers)</i>	27
POWERING THE XEROX 6204 WIDE FORMAT SOLUTION ON/OFF.....	30
<i>Powering On the System</i>	30
<i>Powering Off the System</i>	30
<i>Scan System Warm-up</i>	31
POWERING OFF THE SYSTEM.....	31
DOCUMENT QUALITY.....	33
DOCUMENT QUALITY.....	33

DYNAMIC BACKGROUND REMOVAL	33
<i>Automatic edge detection and document centering</i>	34
DETERMINING DOCUMENT QUALITY	35
<i>What is a good quality document?</i>	35
<i>What is a bad quality document?</i>	35
PREPARING DOCUMENTS	36
SCANNING STRATEGIES	37
IMAGE QUALITY	39
ORIGINAL, TYPE	39
COPY MODE	40
<i>Type, Normal, Line, Photo,</i>	40
SCAN MODE	41
<i>Type, Normal</i>	41
<i>Type Line</i>	42
<i>Type Photo</i>	43
<i>Type, Color</i>	44
BACKGROUND SUPPRESSION	47
COPY	48
MAKING COPIES	49
MAKING COPIES	49
<i>Controlling the scan</i>	49
<i>Image Quality</i>	51
MAKING A COPY WITH THE DEFAULT SETTINGS	52
MAKING A COPY THE SAME SIZE AS THE ORIGINAL DOCUMENT	53
FITTING THE IMAGE TO A FIXED COPY SIZE	54
SCANNING WHEN USING A FOLDER	55
SCANNING WHEN USING A FOLDER	55
<i>Ready to Copy Finisher Screen</i>	56
SCANNING OVERSIZED DOCUMENTS	57
SCANNING OVERSIZED DOCUMENTS	57
LONG DOCUMENTS	57
WIDE DOCUMENTS	57
SPECIAL FEATURES KEYS	59
SPECIAL FEATURES KEYS	59
PRINTER INTERRUPT KEY	60
STORE/RECALL KEY	61
<i>Last Job</i>	61
<i>Job Templates</i>	63
<i>Save Default Template</i>	67
<i>Recall Factory Defaults</i>	68
FINISHER KEY	68
<i>Finisher menu options</i>	70
SETS BUILD KEY	73
<i>Preparing to build the set</i>	73
<i>Building and printing the set</i>	73
BATCH KEY	75
TRANSFORM KEY	76
<i>Margins</i>	76
<i>Justification</i>	78
<i>Transform</i>	79
SAMPLE KEY	82

<i>Copy Mode Sample:</i>	82
<i>Scan Mode Sample:</i>	82
SCANNING TO THE NETWORK (SCAN MODE).....	85
SCANNING TO THE NETWORK (SCAN MODE).....	85
SWITCHING BETWEEN COPY MODE AND SCAN MODE	86
UNDERSTANDING THE READY TO SCAN SCREEN	87
SELECTIONS DISABLED IN SCAN MODE	88
OPERATING IN SCAN MODE.....	88
CLEARING THE SCANNED IMAGES.....	90
MANAGING THE FILE SYSTEM.....	90
MAIN MENU.....	93
MAIN MENU	93
CONFIGURATION MENU	94
<i>LOCALIZATION</i>	95
<i>CONTROL PANEL</i>	96
<i>COPY OPTIONS</i>	97
<i>IMAGE ENHANCEMENTS</i>	102
<i>TIMERS</i>	103
<i>POWER SAVER</i>	105
<i>SCANNER CONTROL</i>	105
SYSTEM INFORMATION MENU	107
<i>SYSTEM DESCRIPTION</i>	108
<i>RECENT FAULT LIST</i>	109
<i>CONFIGURATION PRINTS</i>	110
SYSTEM ADMINISTRATION MENU	112
<i>Entering the system administration password</i>	112
<i>JOB ACCOUNTING</i>	113
<i>FILE SYSTEM</i>	113
<i>CHANGE PASSWORD</i>	117
<i>SECURITY SETTINGS</i>	118
DIAGNOSTICS MENU	119
<i>USAGE METERS</i>	120
<i>CLEAR SCANNER USAGE</i>	121
<i>SCANNER DIAGNOSTICS</i>	121
<i>PASSWORD</i>	136
JOB ACCOUNTING.....	139
JOB ACCOUNTING.....	139
OVERVIEW	139
JOB ACCOUNTING MODE MENU.....	140
SUBMITTING JOBS.....	140
<i>From the Scan System Control Panel</i>	140
<i>Over the network</i>	142
<i>Terminating use under an account</i>	142
CLEANING AND MAINTENANCE - SCAN SYSTEM.....	143
CLEANING AND MAINTENANCE - SCAN SYSTEM.....	143
CLEANING THE PLATEN GLASS, DOCUMENT DRIVE ROLLS, AND BACKER ROLL	144
CLEANING THE CALIBRATION STRIP	145
PROBLEM SOLVING	147
PROBLEM SOLVING.....	147

SPECIFICATIONS	162
SPECIFICATIONS	162
APPENDICES	165
APPENDIX 1: SCANNING RESOLUTIONS AND SPEEDS.....	165
APPENDIX 2: PAPER SHEET SIZES.....	166
APPENDIX 3: PAPER ROLL SIZES	168
APPENDIX 4: FILE FORMATS	169
APPENDIX 6: LED STATUS INDICATORS	170
APPENDIX 7: MAIN MENU STRUCTURE	171
INDEX	173

Safety Notes

Read these safety notes carefully before using this product to ensure that you operate the equipment safely.

Your Xerox/Fuji Xerox product and recommended supplies have been designed and tested to meet strict safety requirements. These include safety agency approval, and compliance with established environmental standards. Please read the following instructions carefully before operating the product and refer to them as needed to ensure the continued safe operation of your product.

The safety and environment testing and performance of this product have been verified using Xerox materials only.

WARNING: Any unauthorized alteration, which may include the addition of new functions or connection of external devices, may affect the product certification. Please contact your Authorized Local Dealer for more information.

Warning Markings

All warning instructions marked on or supplied with the product should be followed.



Warning

This WARNING alerts users to areas of the product where there is the possibility of personal injury



Warning

This WARNING alerts users to areas of the product where there are heated surfaces, which should not be touched.

Electrical Supply

This product shall be operated from the type of electrical supply indicated on the product's data plate label. If you are not sure that your electrical supply meets the requirements, please consult your local power company for advice.



WARNING: *This product must be connected to a protective grounded circuit.*

This product is supplied with a plug that has a protective grounding pin. This plug will only fit into a grounded electrical outlet. This is a safety feature. To avoid risk of electric shock, contact your electrician to replace the electrical outlet if you are unable to insert the plug into it. Never use a grounding adapter plug to connect the product to an electrical outlet that lacks a grounded connection terminal.

Operator Accessible Areas

This equipment has been designed to restrict operator access to safe areas only. Operator access to hazardous areas is restricted with covers or guards, which would require a tool to remove. Never remove these covers or guards.

Maintenance

Any operator product maintenance procedures will be described in the user documentation supplied with the product. Do not carry out any maintenance on this product which is not described in the customer documentation.

Cleaning Your Product

Before cleaning this product, unplug the product from the electrical outlet. Always use materials specifically designated for this product, as the use of other materials may result in poor performance and may create a hazardous situation. Do not use aerosol cleaners, because they may be explosive and flammable under certain circumstances.

WARNING – Electrical Safety Information

- Use only the power cord supplied with this equipment.
- Plug the power cord directly into a grounded electrical outlet. Do not use an extension cord. If you do not know if an outlet is grounded, consult a qualified electrician.

If this machine needs to be moved to a different location, contact a Xerox service representative or your authorized local representative or service support organization.

- Improper connection of the equipment-grounding conductor can result in electrical shock.
- Do not place this equipment where people might step or trip on the power cord.
- Do not place objects on the power cord.
- Do not override or disable electrical or mechanical interlocks.
- Do not obstruct the ventilation openings.
- Never push objects of any kind into slots or openings on this equipment.
- If any of the following conditions occur, switch off the power to the machine immediately and disconnect the power cord from the electrical outlet. Call an authorized local service representative to correct the problem.
 - The equipment emits an unusual noise or odor.
 - The power cord is damaged or frayed.
 - A wall panel circuit breaker, fuse, or other safety device has been tripped.
 - Liquid is spilled into the copier/printer.
 - The equipment is exposed to water.
 - Any part of the equipment is damaged.

Disconnect Device

The power cable is the disconnect device for this equipment. It is attached to the back of the machine as a plug-in device. To remove all electrical power from the equipment, disconnect the power cable from the electrical outlet.

Operational Safety Information

To ensure the continued safe operation of your Xerox/Fuji Xerox equipment, follow these safety guidelines at all times.

Do These:

- Always connect equipment to a correctly grounded power outlet. If in doubt, have the outlet checked by a qualified electrician.
- This equipment must be connected to a protective grounded circuit.

This equipment is supplied with a plug that has a protective grounding pin. This plug will only fit into a grounded electrical outlet. This is a safety feature. To avoid risk of electric shock, contact your electrician to replace the electrical outlet if you are unable to insert the plug into it. Never use a plug that lacks a grounded connection terminal to connect the product to an electrical outlet.

- Always follow all warnings and instructions that are marked on or supplied with the equipment.
- Always exercise care when moving or relocating equipment. Please contact your local Xerox/Fuji Xerox Service Department or your local support organization to arrange relocation of the product to a location outside your building.
- Always locate the equipment in an area that has adequate ventilation and room for servicing. See the Install guide for minimum dimensions.
- Always use materials and supplies specifically designed for your Xerox/Fuji Xerox equipment. Use of unsuitable materials may result in poor performance.
- Always unplug this equipment from the electrical outlet before cleaning.

Do Not Do These:

- Never use a plug that lacks a grounded connection terminal to connect the product to an electrical outlet.
- Never attempt any maintenance function that is not specifically described in this documentation.
- This equipment should not be placed in a built-in installation unless proper ventilation is provided. Please contact your Authorized Local Dealer for further information.
- Never remove covers or guards that are fastened with screws. There are no operator serviceable areas within these covers.
- Never locate the equipment near a radiator or any other heat source.
- Never push objects of any kind into the ventilation openings.
- Never override or "cheat" any of the electrical or mechanical interlock devices.

- Never operate the equipment if you notice unusual noises or odors. Disconnect the power cord from the electrical outlet and contact your local Xerox/Fuji Xerox Service Representative or Service Provider immediately.

Maintenance Information

Do not attempt any maintenance procedure that is not specifically described in the documentation that is supplied with your copier/printer.

- Do not use aerosol cleaners. The use of cleaners that are not approved may cause poor performance of the equipment, and could create a dangerous condition.
- Use supplies and cleaning materials only as directed in this manual. Keep all of these materials out of the reach of children.
- Do not remove covers or guards that are fastened with screws. There are no parts behind these covers that you can maintain or service.
- Do not perform any maintenance procedures unless you have been trained to do them by an Authorized Local Dealer or unless a procedure is specifically described in the user manuals.

Ozone Safety Information

This product will produce ozone during normal operation. The ozone produced is heavier than air and is dependent on copy volume. Providing the correct environmental parameters as specified in the Xerox installation procedure will ensure that the concentration levels meet safe limits.

If you need additional information about ozone, please request the Xerox publication Ozone by calling 1-800-828-6571 in the United States and Canada. In other markets please contact your Authorized Local Dealer or Service Provider.

For Consumables

Store all consumables in accordance with the instructions given on the package or container.

- Keep all consumables away from the reach of children.
- Never throw toner, toner cartridges, or toner containers into an open flame

Radio Frequency Emissions

United States, Canada, Europe, Australia/New Zealand:

NOTE: *This equipment has been tested and found to comply with the limits for a class A digital device, pursuant to Part 15 of the FCC Rules. These limits are designed to provide reasonable protection against harmful interference when the equipment is operated in a commercial environment. This equipment generates, uses, and can radiate radio frequency energy and, if not installed and used in accordance with the instruction manual, may cause harmful interference to radio communications. Operation of this equipment in a residential area is likely to cause harmful interference, in which case the user will be required to correct the interference at his own expense.*

Changes and modifications to this equipment not specifically approved by Xerox/Fuji Xerox may void the user's authority to operate this equipment.

Shielded interface cables must be used with this equipment to maintain compliance with FCC regulations in the United States and the Radiocommunications Act 1992 in Australia/New Zealand as applicable.

Product Safety Certification

This product is certified by the following Agency using the Safety standards listed.

Agency	Standard
TUV Rhineland of North America	UL60950-1 1st (2003) (USA/Canada)
NEMKO	IEC60950-1 Edition 1 (2001)

This product was manufactured under a registered ISO9001 Quality system.

Regulatory Information

CE Mark

The CE mark applied to this product symbolizes Xerox's declaration of conformity with the following applicable Directives of the European Union as of the dates indicated:

January 1, 1995: Council Directive 72/23/EEC amended by Council directive 93/68/EEC, approximation of the laws of the member states related to low voltage equipment.

January 1, 1996: Council directive 89/336/EEC, approximation of the laws of the member states related to electromagnetic compatibility.

March 9, 1999: Council Directive 99/5/EC, on radio equipment and telecommunications terminal equipment and the mutual recognition of their conformity.

A full declaration of conformity, defining the relevant directives and referenced standards, can be obtained from your Authorized Local Dealer.

WARNING: *In order to allow this equipment to operate in proximity to Industrial Scientific and Medical (ISM) equipment, the external radiation from the ISM equipment may have to be limited or special mitigation measures taken.*

WARNING: *This is a Class A product. In a domestic environment the product may cause radio frequency interference, in which case the user may be required to take adequate measures.*

WARNING: *Shielded interface cables must be used with this product to maintain compliance with Council Directive 89/336/EEC.*

Environmental Compliance

USA

Energy Star As an ENERGY STAR partner, Xerox Corporation has determined that this product meets the ENERGY STAR guidelines for energy efficiency.

ENERGY STAR and the ENERGY STAR mark are registered U.S. marks.

The ENERGY STAR Office Equipment Program is a team effort between U.S., European Union and Japanese governments and the office equipment industry to promote energy-efficient copiers, printers, fax, multifunction machines, personal computers, and monitors. Reducing product energy consumption helps combat smog, acid rain, and long-term changes to the climate by decreasing the emissions that result from generating electricity.

Xerox ENERGY STAR equipment is preset at the factory to enter a “low power” state and/or shut off completely after a specified period of use. These energy-saving features can reduce product energy consumption in half when compared to conventional equipment.

Canada

Environmental Choice:

Terra Choice Environmental Services, Inc. of Canada has verified that this Xerox product conforms to all applicable Environmental Choice EcoLogo requirements for minimized impact to the environment.

As a participant in the Environmental Choice program, Xerox Corporation has determined that this product meets the Environmental Choice guidelines for energy efficiency.

Environment Canada established the Environmental Choice program in 1988 to help consumers identify environmentally responsible products and services. Copier, printer, digital press, and fax products must meet energy efficiency and emissions criteria, and exhibit compatibility with recycled supplies. Currently, Environmental Choice has more than 1600 approved products and 140 licensees. Xerox has been a leader in offering EcoLogo approved products.

Getting to know the WIDE FORMAT COPY SYSTEM

This manual contains operating instructions for the user and the system administrator for the XEROX WIDE FORMAT COPY SYSTEM 8825/8830/8850/510 Series, 721P, 6030/6050, and 6204 with version 12.0 FreeFlow Accxes firmware loaded into the Controller.

NOTE: For the 6030/6050 printers that want to use the FreeFlow Accxes firmware features, the printer also needs to be connected to a separate PUN or YKE controller, referred to as the FreeFlow Accxes Print Server. The Web Print Management Tool software will be loaded on the print server.

Your XEROX WIDE FORMAT COPY SYSTEM is an integrated solution for electronically scanning and then printing good quality copies of the images for engineering or architectural size documents. The WIDE FORMAT COPY SYSTEM consists of the WIDE FORMAT SCAN SYSTEM and Control Panel for capturing images, the FreeFlow Accxes Controller for processing these images, and XEROX WIDE FORMAT COPY SYSTEM Printers 8825, 8830, 8850, 510 Series, 721P, 6030/6050, or 6204.

The WIDE FORMAT COPY SYSTEM has two modes of operation - COPY and SCAN.

- In the COPY mode, documents are scanned, temporarily stored in memory or on the FreeFlow Accxes Controller hard disk, and then sent to the local Printer as soon as the Printer is available.
- In the SCAN mode:
 - Scan-to-Net**: Documents are scanned and then stored on the FreeFlow Accxes Controller hard disk for later retrieval over a network by a remote device.
 - Scan-to-FTP**: Scanned images can be transferred to 4 remote FTP destinations. The scanned images are not stored on the FreeFlow Accxes Controller's hard drive. The FTP feature is located on the Sample Mode screen.

The WIDE FORMAT COPY SYSTEM allows concurrent printing, copying, and scanning to the network, so there is no need to wait for the Printer to finish before scanning the next document.

The XEROX WIDE FORMAT COPY SYSTEM contains Dynamic Background Suppression technology. Dynamic Background Suppression examines a sample of the document intelligently and makes automatic image quality adjustments that yield a good copy even from poor original documents. The document width is automatically detected and the centering of a scanned original for most opaque documents is adjusted. Translucent documents (transparencies, clear film, etc.) in most cases will not be detected.

The Productivity feature was introduced with version 10.0 firmware and requires that a new WIDE FORMAT SCAN SYSTEM has a new Document Feed-in Tray. Sensors built into the Feed Tray measure the document width without doing a prescan, which increases the document and copy throughput, thereby increasing productivity.

NOTE: Documents must be centered when using the sensors for width detection.

For documents that require additional adjustments to obtain the best copy quality, a variety of image quality and reduction/enlargement settings are available. All of these functions are controlled from the Scan System Control Panel. This Control Panel, which is mounted on top of the Scan System, receives all power and information from the Scan System.

Feature Keys

Print and Copy feature keys are standard for all printers using FreeFlow Accxes 12.0 firmware, except for the XEROX WIDE FORMAT 6030/6050 Printer. In the 12.0 firmware, the following feature keys need to be loaded before the features can be used. See the Feature Key instructions and Coupon Exchange screens on the www.xerox.com website.

- XEROX WIDE FORMAT Scan System Features:
 - Scan-to-Net Feature Key** – to create an electronic file from a scanned image.
 - Scan-to-Print Feature Key** – to scan, create a preview, and send the scanned image to the printer when the Scan-to-Net feature is present.
 - Color Enablement Feature Key** – allows color scanning when the Scan-to-Net feature is present.
 - Speed Enhancement Turbo II Feature Key** – 4 inches per second (ips) for 36" wide media.
 - Speed Enhancement Turbo III Feature Key** – HFT, PUN, YKE, YKE-N Controllers only: 7.33 ips in Copy Mode.
- XEROX WIDE FORMAT 6030/6050 Printer:
 - Print Server Enablement Feature Key** – Enables print and copy mode for a remote printer.

- XEROX WIDE FORMAT Printers and Scan Systems:
 - Job Accounting Feature Key** – Job accounting enables the tracking of media usage data. The Account Management Tool (AMT), or some other external accounting tool, is used to assign a User ID, Account ID, and Printer ID. It then collects and tallies the stored data from the printers.
 - PostScript Feature Key** – This enables the interpretation of Adobe Post Script 3, PDF 1.6 for the YKE-N Controller, PDF 1.4 and 1.5 for the YKE controller, and PDF 1.3 for all other FreeFlow Accxes Controllers.
 - Disk Image Overwrite Feature Key** – Enables the security options for overwriting image data on the hard drive. The immediate overwriting of data to DOD specification is such that the system, at any point in its operation, can be considered secure and all data will be removed no matter what operation the customer is performing.
 - OS Enablement Feature Key** – Enables the YKE controller to print, copy, and scan.

NOTE: *The Special Features Key section of this document refers to physical buttons (keys) that are on all the XEROX WIDE FORMAT Scan Systems.*

Scan System standard components

The illustrations below show the components of the WIDE FORMAT SCAN SYSTEM. These components are standard on the XEROX WIDE FORMAT COPY SYSTEM 8825, 8830, 8850, 6030/6050, 6204, and 510 Series. The Stand is standard or optional on the 8850. With the exception of the Stand and Standard Organizer, the components are standard on the 721P. Following the illustrations are descriptions of each of the components.

WIDE FORMAT SCAN SYSTEM Front View

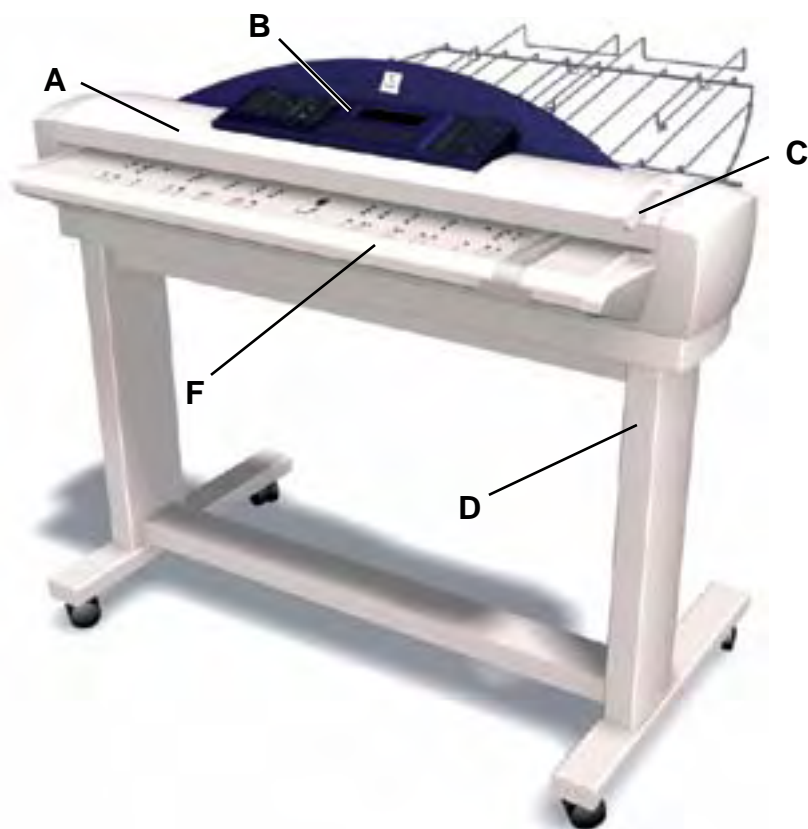

A. Document Handler

Raise the Document Handler for routine maintenance functions and to access the optical paper sensors for diagnostic routines.

B. Scan System Control Panel

The control panel allows the selection of options and features and contains a graphical display for the communication of information and instructions. Refer to Scan System Control Panel for additional information.

C. Thick Document Lever

The Thick Document Lever is used to adjust the Scan System for thick documents and to remove documents from the Scan System feed mechanism. When setting the thickness for a document, raise the lever to the next thickness. If the document slides past the Feed Rolls into the Document Handler, lower the Lever to the next position.

D. Stand

The Stand is standard with the XEROX WIDE FORMAT COPY SYSTEM 8825, 8830, 8850, 6030/6050, 6204, and 510dp series. It is optional with the 721P.

E. Standard Organizer (not shown in previous photo)

The Organizer is located on the front of the Scan System. It is useful for holding multiple documents that are to be scanned. It has two

extensions at its end that can be pulled out to accommodate longer documents (up to size E or A0).

F. Productivity Document Feed Tray

Insert documents to be scanned face down and centered into the Document Feed Tray. Provides built-in Document Width Sensors that eliminate the need to prescan document to do width measurement. This increases the document throughput resulting in higher productivity with a WIDE FORMAT COPY SYSTEM. This functionality is only available on the newer WIDE FORMAT SCAN SYSTEM.

WIDE FORMAT SCAN SYSTEM Rear View

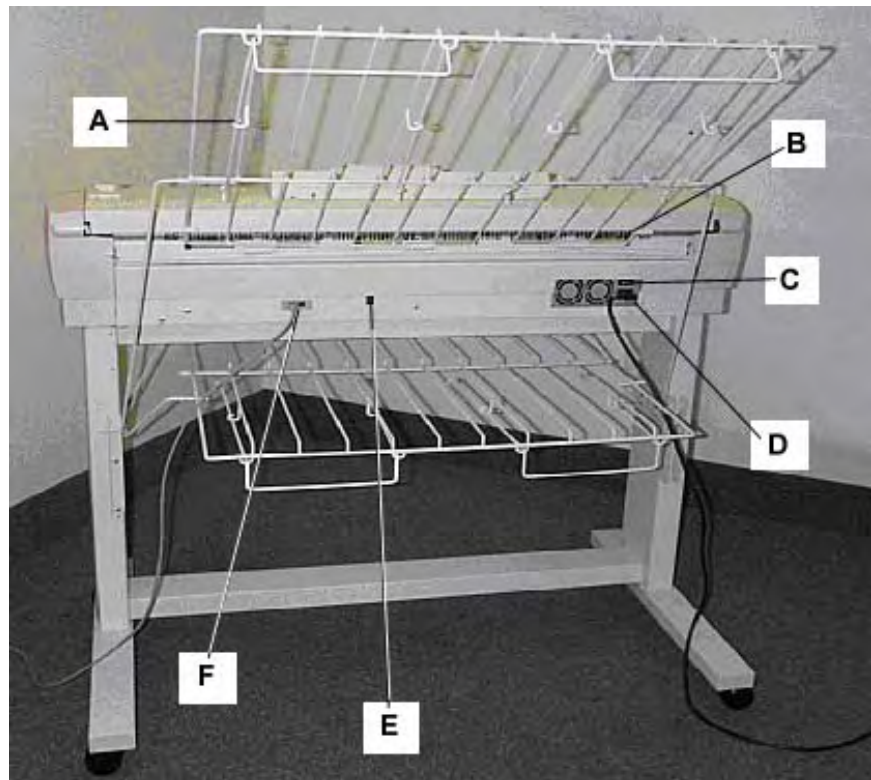

- | | |
|------------------------|----------------------------------|
| A: Standard Stacker | D: Power Cord and Connector |
| B: Document Exit Slot | E: Status Indicator LED |
| C: Power On/Off switch | F: IEEE 1394 Cable and Connector |

NOTE: Components shown above with the exception of the Standard Organizer are also available on all WIDE FORMAT SCAN SYSTEMS

A. Standard Stacker

The Stacker is located at the rear of the Scan System. When the AUTORETURN feature is set to REAR, documents exit the Scan System onto the Stacker. The Stacker can be adjusted to any one of four positions by raising or lowering it. The height of the Stacker should be adjusted to accommodate the document being scanned. It has two extensions at its end that can be pulled out to accommodate longer documents (up to size E or A0). When scanning most common weight (20 lb, 80gsm) documents, move the Stacker to the 2nd rung from the bottom.

NOTE: All thick documents, and documents over 36 inches (914 mm), exit from the rear of the Scan System (regardless of the AUTORETURN setting). When scanning thick documents, the Stacker must be set to the lowest position for optimum performance.

B. Document Exit Slot

When the DOCUMENT RETURN feature is set to REAR, documents exit the Scan System through this slot and are delivered to the rear Stacker.

C. Power On/Off Switch

This switch turns the Scan System on and off. Press this switch to the on (I) position to turn on the Scan System and to the off (O) position to turn off the Scan System.

D. The Power Cord supplies power to the Scan System. Plug one end of the cord into the Scan System and the other end into an electrical outlet.

E. Status LED

The digital status LED provides an indication of the condition of the Scan System and communications with the FreeFlow Accxes Controller. A letter "P", displayed on the LED Display on the rear of the Scan System, indicates that the Scan System is operating normally and has established communications with the controller.

F. IEEE 1394 Cable and Connector

The IEEE 1394 Cable is the communications link between the Scan System and the Controller. Plug one end of the cable into either one of the IEEE 1394 connections at the rear of the Scan System. Plug the other end into the IEEE 1394 connection on the Controller.

Scan System compact components

The illustrations show the optional compact Stacker and organizer that are available for the WIDE FORMAT SCAN SYSTEM. The compact components allow the XEROX WIDE FORMAT COPY SYSTEM to be installed in sites where space requirements are at a premium.

Front View of the Wide Format Scan System

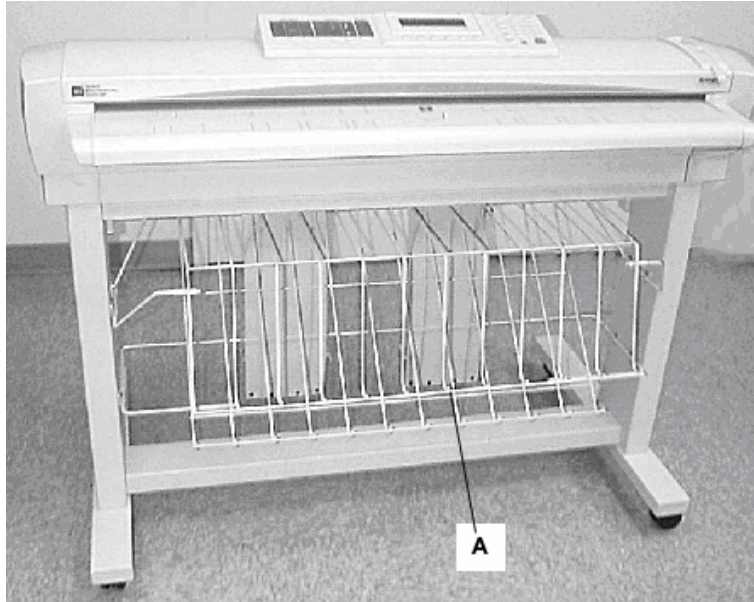

A: Compact Organizer

Back View of the Wide Format Scan System

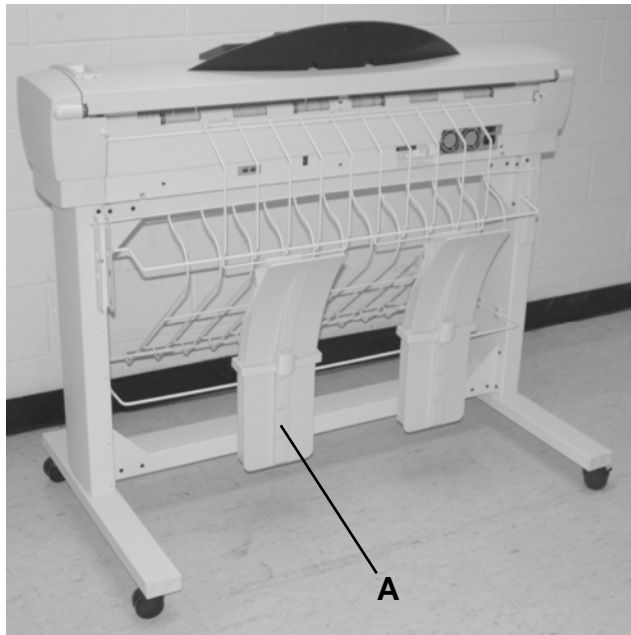

A: Compact Stacker

Scan System Control Panel

The Scan System Control Panel is divided into three sections:

- The options keys section (A), which contains the - **Media Selection**, **Image Quality**, and **Reduce/Enlarge** options selections
- The graphical display (B) and the navigation keys (F) section.
- The right-hand section, which contains the numeric keypad (D), the special features keys (E), and the scan control keys (C).

If the BEEP function is enabled (factory default), a beep sound will be heard when a key is pressed. If an incorrect key is pressed, a multiple beep sound will be heard.

Scan System Control Panel



- A:** Option Keys section
B: Graphical Display
C: Scan Control keys

- D:** Numerical Key pad
E: Special Features keys
F: Navigation keys

OPTIONS KEYS

The left side of the Scan System Control Panel contains the keys for the selection of options. It is divided into three areas - **Media Selection**, **Image Quality**, and **Reduce/Enlarge**.

To select an option, press the key(s) beneath the option. In some cases, a screen requiring a selection or input is displayed on the graphical

display. When an option is selected, the indicator lamp to the left of the option illuminates.

The illustration below depicts the options portion of the Scan System Control Panel.

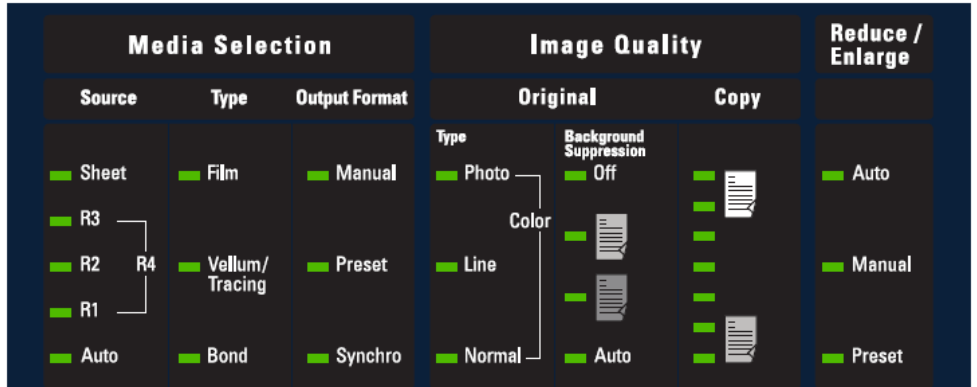

Control Panel Options Area

Media Selection

The Media Selection area of the Scan System Control Panel allows you to select the media **Source**, **Type**, and **Output Format**. The illustration below depicts the **Media Selection** portion of the control panel.

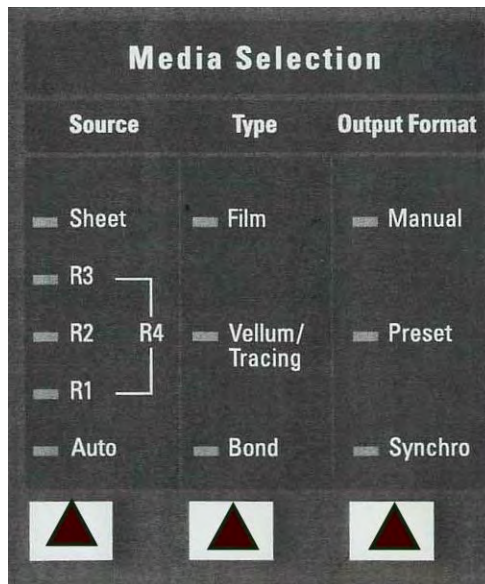

Media Selection Area

Source

The **Source** option allows you to select the source of the media on which the image will be printed. To select the media source, press the key beneath the Source settings until the desired source indicator lamp illuminates.

The **Source** settings are:

- **Sheet** – This setting tells the Printer to print from a manually inserted sheet of media.
- **R4** – This setting is applicable to the WIDE FORMAT COPY SYSTEM 721P and 6050. When R4 is selected, both the R1 and R3 indicator lamps illuminate and the Printer then selects the media stored on Roll 4.
- **R3** –When it is selected, the R3 indicator lamp illuminates and the Printer selects the media stored on Roll 3.
- **R2** – This setting tells the Printer to select the media stored on Roll 2.
- **R1** – This setting tells the Printer to select the media stored on Roll 1.
- **Auto** (factory default) – This setting automatically selects the roll containing the media that best fits the size of the captured image. For most documents, the Scan System is able to automatically detect the width of the scanned document. This permits the Auto function to automatically select the most appropriate roll of media.

NOTE: *The presence of the Sheet feature and the amount of rolls available vary by the type of WIDE FORMAT PRINTER. If these options are not installed, they cannot be selected. To print from a cut sheet, Sheet mode must be explicitly selected. The Auto mode cannot select a cut sheet.*

Type

The **Type** option allows you to select the kind of media on which to print – **Bond**, **Vellum/Tracing**, or **Film**. To select the media type, press the key beneath the Type settings until the desired type indicator lamp illuminates.

NOTE: *Only media types actually loaded into the Printer can be selected. When a roll is selected, the media type for that roll is automatically selected also. If more than one media type is loaded when the media source is set to **Auto**, the default choice priority is **Bond** (first), **Vellum** (second), and **Film** (third). Refer to the applicable Printer Operator Manual for instructions about how to load rolls and specify the width and media type.*

Output Format

The Output Format option allows you to select the size to which the roll feed media will be cut. It has three modes – Manual, Preset, and Synchro.

Manual

Manual allows you to enter the desired length and width manually.

To select the **Manual** mode:

1. Press the key beneath **Output Format** until the **Manual** indicator lamp illuminates. The CUSTOM OUTPUT FORMAT screen is displayed.

NOTE: *If the indicator lamp is already lit, press the key once to display the screen.*

CUSTOM OUTPUT FORMAT	
ENTER CUSTOM MEDIA SIZE:	
WIDTH (11.0 -36.0):	11.0 IN
LENGTH (8.3 – 1200.0):	8.5 IN

Custom Output Format Screen

2. Press the **Previous** or **Next** key to select WIDTH or LENGTH.
3. Press the **Enter** key to confirm the choice.
4. Use the numeric keypad to enter the desired value.

NOTE: *The entered value must be within the limits shown in parentheses on the screen.*

5. Press the **Enter** key to confirm the value.
6. Repeat steps 3 to 5 to enter the value for the remaining setting.
7. When the values for WIDTH and LENGTH are correct, press the **Exit** key to return to the READY screen.

Preset

Preset allows you to select a predefined length to which the roll media should be cut during printing. The associated width specification will depend on the **Media Source** selection. If the **Media Source** selection is set to **Auto**, the system will select the roll of media that best matches the width specification. If **Media Source** is set to **R1**, **R2**, **R3**, or **R4**; the system will use the selected roll regardless of the width specification.

To select the **Preset** mode:

1. Press the key beneath **Output Format** until the **Preset** indicator lamp illuminates. The PRESET OUTPUT FORMAT screen is displayed.

NOTE: If the indicator lamp is already lit, press the key once to display the screen.

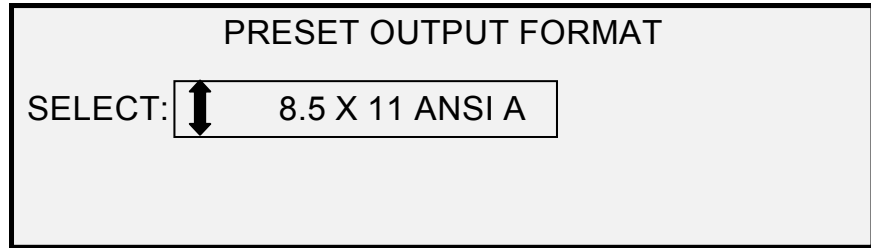

Preset Output Format screen

2. Press the **Previous** or **Next** key to select an item from the list.

NOTE: Formats can be added or removed from this list. Refer to "Custom Media Formats" in the "Main Menu" section for more information.

3. Press the **Enter** key to confirm the choice and return to the READY screen.

Synchro

When the **Synchro** mode is selected, the length of the original is measured as it passes through the Scan System and automatically cuts the media at the Printer to match the length of the original document.

Synchro is the factory default. To select the **Synchro** mode, press the key beneath **Output Formats** until the **Synchro** indicator lamp illuminates.

Image Quality Area

The **Image Quality** area of the Scan System Control Panel allows you to make corrective adjustments to the image and extract the best possible copy quality from an original document. It contains the **Type**, **Background Suppression**, and **Copy** options.

The illustrations below depict the **Image Quality** portion of the Control Panel for FreeFlow Accxes software version 12.0 and SCAN SYSTEM firmware version 3.2.6 or higher.

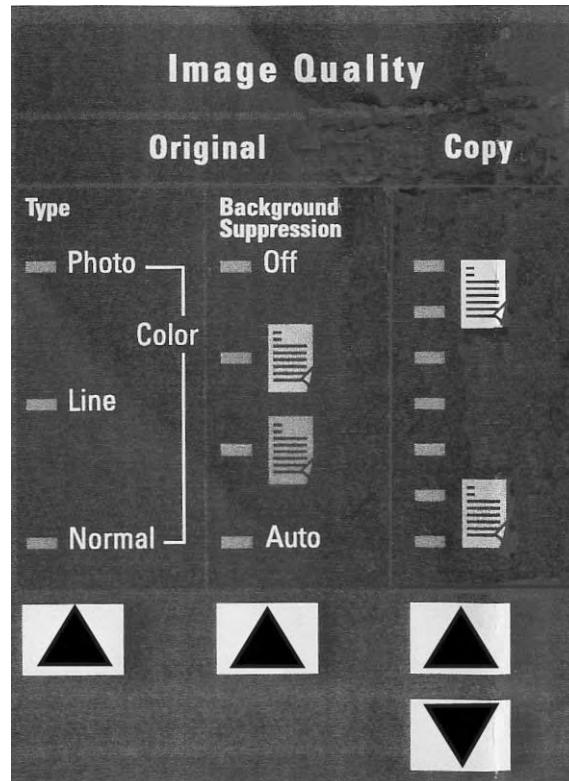
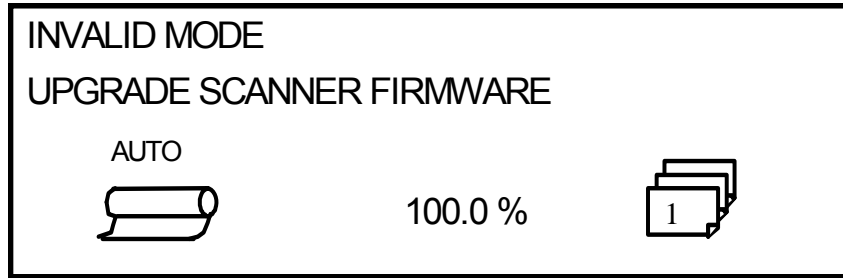

Image Quality Area

The SCAN SYSTEM firmware must be at version 3.2.6 or greater to support **Normal**, **Line**, **Photo**, or **Color** Type. If the SCAN SYSTEM is not at the required version, there will be an error message.

Depending on what **Mode** is selected (COPY or SCAN) the message will be displayed as show below.



Invalid Mode in Copy Mode

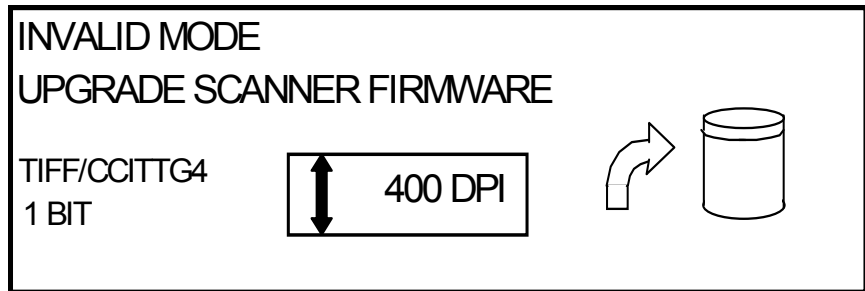

Invalid Mode screen in Scan Mode

Original, Type

*The **Type** option allows you to specify the type classification of your document. To select the document type, press the key beneath the **Type** settings until the desired **Type** indicator lamp illuminates.*

Normal

Normal — (factory default) Select **Normal** for most copying needs. This setting will provide good image quality for copying most types of drawings containing text, line art, or a mixture of these. Shaded areas will be preserved. The TIFF, CALS, and PDF file types are available for Normal images.

In the SCAN mode, the following screen is displayed when the **Normal** key is pressed.

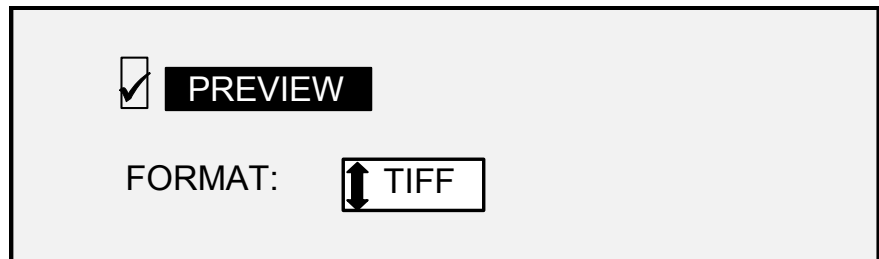

Scan Options (Normal) Screen

Line — Select **Line** for an image containing fine lines, especially pencil. This selection produces high contrast and dark black images. The TIFF, CALS, and PDF file types are available for Line images. If the **Mode** selected is SCAN, and the Scan-to-Net feature key is installed, the SCAN OPTION (LINE) screen will be displayed. If the COPY mode is selected, the READY TO COPY screen will be displayed. Refer to the "Image Quality" section of this manual for additional information.

SCAN OPTIONS (LINE)

PREVIEW

FORMAT:

Scan Options (Line) Screen

Photo — Select **Photo** when the document contains a gray scale or color image, such as a photograph. TIFF is the file type that is available for Photo images. If the Copy Mode is selected, the READY TO COPY screen will be displayed. In Scan Mode, the following screen will be displayed. Refer to the Image Quality section of this manual for additional information.

SCAN OPTIONS (PHOTO)

PREVIEW

COMPRESSION:

FORMAT:

Scan Options (Photo) Screen

NOTE: The **Background Suppression** option cannot be used with the **Photo** setting. If **Photo** is selected, **Background Suppression** is automatically set to OFF.

Color — **Color** is only selectable in the SCAN mode. Select **Color** when scanning full color documents. When **Color Type** is selected, a version of the following screens will be displayed. The content of the screen will depend on the selected FORMAT and COMPRESSION. The following screens will only be displayed in SCAN mode when the Scan-to-Net and Color Enablement feature keys are installed. The **Normal** and **Photo** LED's will be lit when **Color** is selected. The selections that appear on the screen depend on the FORMAT and COMPRESSION selections.

SCAN OPTIONS (COLOR)

PREVIEW FORMAT:

COMPRESSION:

Scan Options (Color) Screen - Packbits Compression Selection

SCAN OPTIONS (COLOR)

PREVIEW FORMAT:

COMPRESSION:

PALETTE:

Scan Options (Color) Screen - Index Compression Selection

SCAN OPTIONS (COLOR)

PREVIEW FORMAT:

COMPRESSION:

Scan Options (Color) Screen - Normal Compression Selection

Background Suppression

Background Suppression

The **Background Suppression** option enables you to make adjustments for documents that contain poor contrast between the foreground image and the background.

Four **Background Suppression** choices are provided:

Off This setting disables **Background Suppression**. All the characteristics of the original document with minimum alteration are reproduced on the copy. Choose this selection when:

- The lead edge of the document is very different from the rest of the document (e.g., the lead edge contains a black border).
- Maps with grayscale or color content may copy best in this mode.
- To retain more light color information, such as light gray or yellow.

NOTE: If **Photo** or **Color** is selected as the **Original, Type**, the **Off** setting is automatically selected. The contrast can still be adjusted by pressing the key(s) beneath **Image Quality, Copy**.

 (Light) This setting works best for documents on translucent or transparent media, such as vellum (tracing paper) or film, or with medium levels of colored background on opaque media or for documents. Such documents have a higher contrast between the foreground and background than dark documents, but less contrast than normal documents.

 (Dark) Use this setting for documents with a dark background or with medium contrast between the foreground and background. In this mode, the background is not suppressed, but the foreground image is improved to increase the contrast.

Auto (factory default) – The Scan System automatically adjusts the image quality parameters to obtain the best copy.

NOTE: All three **Background Suppression** settings can be adjusted further by changing the contrast setting in the **Image Quality and Copy** area.

Background Suppression can operate in either the dynamic or static mode.

Select the **Menu** key> CONFIGURATION>IMAGE ENHANCEMENT.

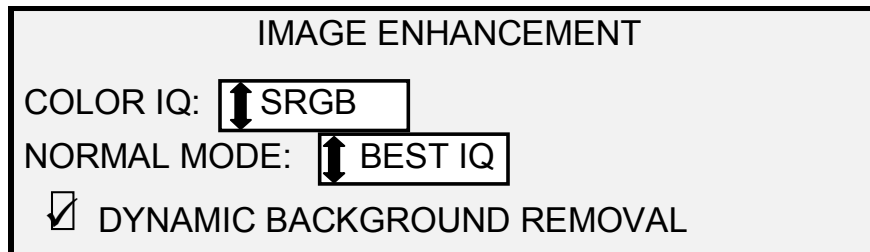

Image Enhancement Screen

When enabled, the dynamic mode will monitor the whole document and adjust the image quality settings as the document is being scanned in order to optimize the background of the copy.

When disabled, the static mode monitors the first two inches to establish a background threshold that is used throughout the document in order to optimize the background of the copy.

Static Background Suppression is not available in the **PRODUCTIVITY** mode.

Copy

The **Copy** option allows you to darken or lighten the contrast of the copy with respect to the original document. Press the down arrow key to darken the contrast. Press the up arrow key to lighten the contrast. The indicator lamp for the selected contrast setting illuminates. The middle contrast setting is the factory default setting.

You can use this feature to further adjust the effects of the **Type** and **Background Suppression** selections. The feature operates with all four **Background Suppression** modes.

NOTE: **Copy** is not selectable in **Color** mode.

Reduce/Enlarge

The **Reduce/Enlarge** area of the Scan System Control Panel allows you to select one of three reduction/enlargement modes - **Auto**, **Manual**, and **Preset**. The illustration below depicts the Reduce/Enlarge portion of the Control Panel.

NOTE: *Reduce/Enlarge can only be selected in Copy mode.*

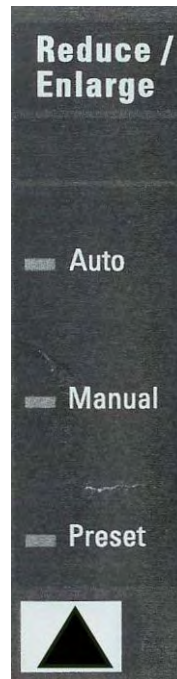

Reduce/Enlarge Area

Auto

Auto automatically adjusts the reduction/enlargement to fit the size of media selected. To select the **Auto** mode, press the key beneath **Reduce/Enlarge** until the **Auto** indicator lamp illuminates.

NOTE: *The size of the output media must be known in advance for this feature to operate. Therefore, **Auto** is not a valid selection if both the **Synchro** cut option and the **Sheet** and **Auto** media source options are selected. If you select this combination, an **INVALID AUTO COMBINATION** status is displayed.*

Manual

Manual allows you to reduce the image captured by the Scan System to as little as 25%, or as much as 400%, of the original size before the copy is printed.

To select the **Manual** mode:

1. Press the key beneath **Reduce/Enlarge** until the **Manual** indicator lamp illuminates. The **MANUAL REDUCTION/ENLARGEMENT** screen is displayed.

NOTE: If the indicator lamp is already lit, press the key once to display the screen.

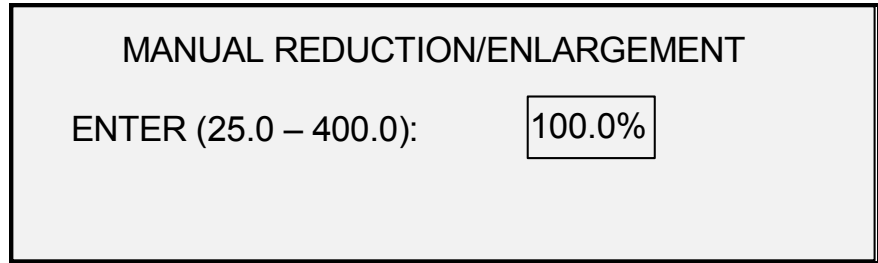

Manual Reduction/Enlargement Screen

2. Enter a reduction/enlargement between 25 and 400. You can select any value between these limits in 0.1% increments.
3. Press the **Enter** key to confirm your choice and return to the READY screen. The READY screen now displays the new reduction/enlargement percentage.

NOTE: Pressing the **Exit** key rejects the choice and retains the previous setting.

Preset

Preset (factory default) allows you to select a predefined reduction or enlargement percentage.

To select the **Preset** mode:

1. Press the key under **Reduce/Enlarge** until the **Preset** indicator lamp illuminates. The PRESET REDUCTION/ENLARGEMENT screen is displayed.

NOTE: If the indicator lamp is already lit, press the key once to display the screen.

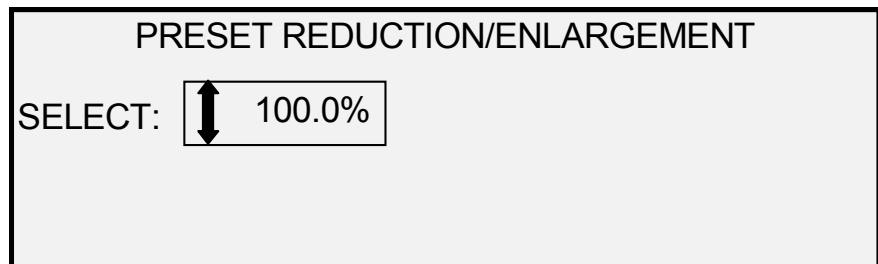

Preset Reduction/Enlargement Screen

2. Press the **Previous** or **Next** key until the desired reduction/enlargement ratio is displayed. The possible choices are any combination of the following:
 - 50%, 100% (default), and 200%
 - 65% and 129%, if the ANSI and ARCH sizes are enabled

- 71% and 141%, if the ISO A, ISO B or JIS B sizes are enabled
- Up to six additional preset values, if these values have been defined using the CUSTOM R/E presets menu functions.

NOTE: Refer to “Media Series” in the “Main Menu” section for more information about enabling media series and defining custom presets.

3. Press the **Enter** key to confirm your choice and return to the READY screen. The READY screen now displays the new reduction/enlargement percentage.

NOTE: Pressing the **Exit** key rejects the choice and retains the previous setting.

Graphical Display and Navigation Keys

The middle portion of the Scan System Control Panel contains the graphical display and the navigation keys. The illustration below depicts the middle portion of the Control Panel.

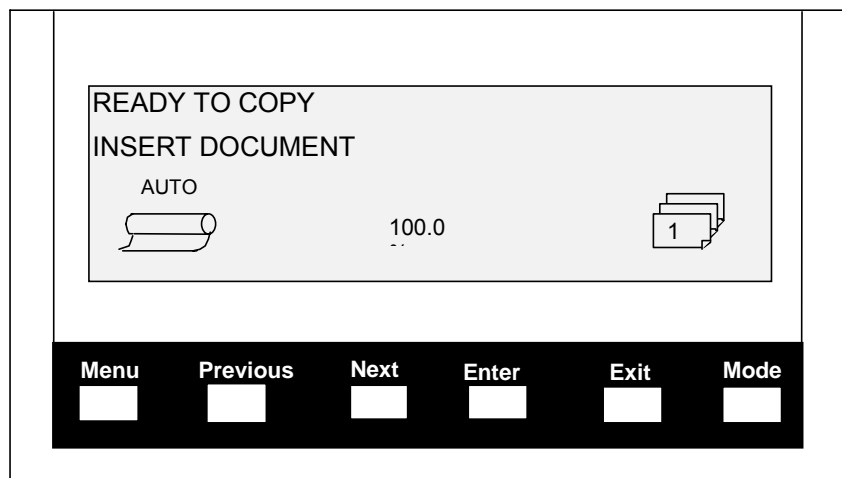

Navigational Keys and Graphical Display Area

Graphical Display

The graphical display provides you with information and instructions pertaining to the system. It consists of up to four lines of text and graphics. The display can be adjusted upward for better viewing.

Navigation Keys

The navigation keys, located beneath the display, are used to move through the menu screens, to select items on the screen, and to specify parameters when an options screen is displayed. Some keys have more than one function depending on the screen being displayed at the time. These special functions are explained in later sections.

Menu

The **Menu** key invokes the main menu. If a menu screen is already being displayed, pressing this key exits the menus and directly returns you to the previous READY State.

Previous

The **Previous** key highlights the previous item in a displayed list.

Next

The **Next** key highlights the following item in a displayed list.

Enter

The **Enter** key either confirms the selection of the currently highlighted item or confirms an entered numeric value.

Exit

The **Exit** key cancels a selection operation and returns you to a previous screen. It has other effects, depending upon the specific situation, that are explained later.

Mode

The **Mode** key is a valid selection only when READY is displayed on the screen. This key is used to switch between the READY TO COPY mode and the READY TO SCAN mode. The SCAN mode can be entered only if the Scan-to-Net feature key is loaded.

Below are examples of the READY screen in COPY and SCAN modes.

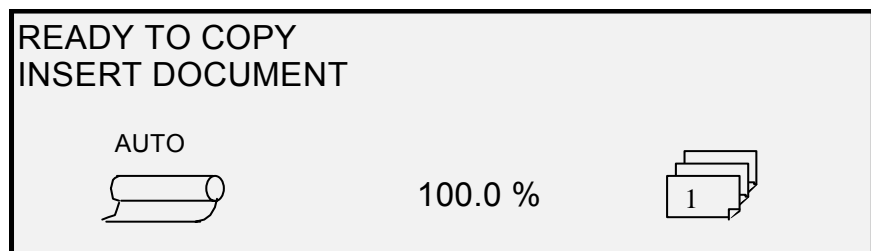

Ready to Copy Screen

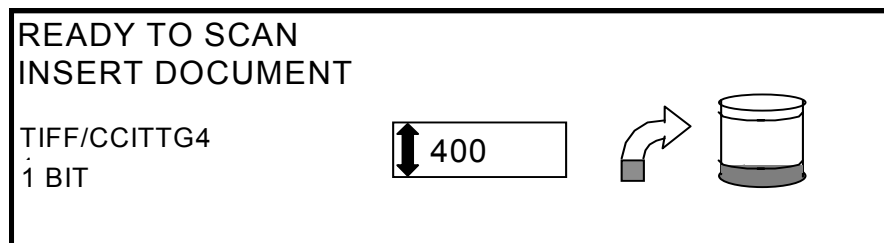

Ready to Scan Screen

In the COPY mode, the scanned image or set of images is printed on the Printer and then deleted from the hard disk.

In the SCAN mode, the scanned image or set of images is stored on the hard disk for later retrieval over a network by a client running on a remotely located device. Scanned images can also be transferred to four remote FTP destinations from the Samples Mode screen. Refer to the "Scanning to the Network" section for more information about the SCAN mode.

NOTE: The SCAN mode is an optional feature that is enabled by installing the Scan-to-Net feature key. Contact your XEROX representative for ordering information.

Numeric Keypad and Special Features/Control Keys

The right side of the Scan System Control Panel contains a numeric keypad for entering quantities, keys for selecting other features, and keys for controlling the scanning and printing of images. To the left of some of the keys are indicator lamps that illuminate when the associated feature has been selected.

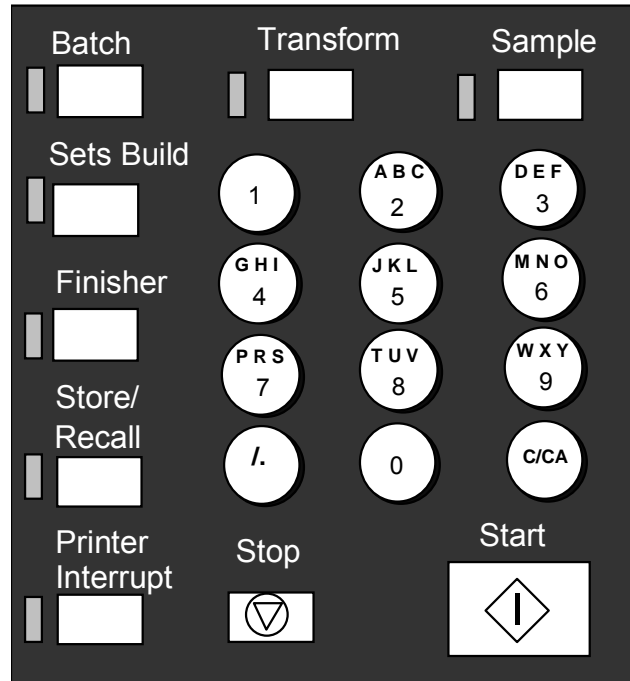

Numeric Keypad

The numeric keypad contains the **0** to **9** numeric keys, the decimal key and the **C/CA** key.

Numeric (**0-9**) keys

These keys are used for numeric entry, password entry, and copy quantity fields.

NOTE: The letters next to the numbers are for entering User and Account Ids and Scan Directory information.

/. (Decimal key)

This key is used for entering alphanumeric values and string entries for account and user identities and directory names.

NOTE: The forward slash (/) to the left of the decimal is for future use.

C/CA (Clear/Clear All) key

This key has the following functions:

- When in READY TO COPY mode, one press clears the current copy count to one. Two presses within one-second resets the copy parameters to the default settings.
- When in READY TO SCAN mode, pressing this key brings up the CLEAR SCANNED IMAGE screen.

- When in READY TO BUILD SET mode, pressing this key brings up the scanned document (Refer to **Sets Build** key section of this manual for additional information).
- When in the entry state for numeric entry fields, pressing this key acts as a backspace/delete key. When the last digit is deleted, the numeric field goes to zero.
- When in password entry and string entry fields, pressing this key acts as a backspace key. When the last character is deleted, the field is blank.
- When in quantity entry fields, pressing this key clears the field to 1.

Special Features Keys

The special features keys are used to activate, deactivate, or change parameters associated with special features. An indicator lamp adjacent to each feature key illuminates whenever the corresponding feature is activated.

The special features keys include the **Printer Interrupt**, **Store/Recall**, **Finisher**, **Sets Build**, **Batch**, **Transform**, and **Sample** keys. These keys are described in detail in the Special features keys section of this guide.

Scan Control Keys

The **Start** and **Stop** keys control the scanning and printing of images.

Start key:

The **Start** key is used to begin the copy sequence when the AUTOSCAN feature is not enabled.

If you press the **Start** key while the status is NOT READY or INVALID AUTO COMBINATION, the system will beep to indicate an invalid key press. If you press the **Start** key while the status is READY TO COPY or READY TO SCAN, the document is scanned.

NOTE: *INVALID AUTO COMBINATION indicates an incompatible combination of **AUTO** settings (i.e., **Media Selection**, **Source** set to **Sheet** or **Auto**, **Media Selection**, **Output Format** set to **Synchro**, and **Reduce/Enlarge** set to **Auto**).*

Stop key:

The **Stop** key allows you to immediately stop the scanning operation to prevent damage to the document. Any scanned information is discarded. The READY screen prompts you to remove the document.

The Printer and the FreeFlow Accxes Controller

For detailed operating instructions about the Printer and Controller components of the WIDE FORMAT COPY SYSTEM and about network connectivity, refer to the documentation listed below.

- *FreeFlow Accxes System & Web Print Management Tool Setup Guide*
- *FreeFlow Accxes Controller Service Manual for HFT/PUN*

- *Xerox FreeFlow Accxes Controller Service Manual for YKE/YKE-N*

Powering On the WIDE FORMAT COPY SYSTEM

To power on the XEROX WIDE FORMAT COPY SYSTEMS, you first must switch on the Scan System and wait for 30 seconds or check that a “P” is displayed on the status LED in the back of the Scan System. Then switch on the Printer, then the Controller.

Follow the instructions provided in this section for your system.

Initial power-on

For all controllers except the YKE controller and the YKE-N controller, when the WIDE FORMAT SCAN SYSTEM is present, the DDS parameter must be set to Enabled in order to enable the COPY/SCAN functionality of the scanner. Go to the Web Print Management Tool. Select Configuration > Printer > Printer Setup > DDS Enabled. Be sure that the DDS Enabled checkbox is selected. If the DDS Enabled checkbox is not selected, then the COPY/SCAN functionality will be disabled.

The default for this parameter is disabled. You must ensure that it is set to Enabled when powering on the XEROX WIDE FORMAT SCAN SYSTEM for the first time. After setting the DDS parameter, wait 30 seconds, and then power the system off then on. Once you enable this parameter, it will remain enabled (even following future software upgrades).

For the XEROX WIDE FORMAT COPY SYSTEM 510 Series or 8825, 8830, and 8850, you can set this parameter from either the CONTROLLER CONFIGURATION screen of the Printer Control Panel or on the Web Print Management Tool. For the XEROX WIDE FORMAT COPY SYSTEM 6030/6050, 721P, and 6204, you can only set this parameter from the Web Print Management Tool, (Configuration > Printer > Printer Setup > DDS Enabled).

Switching on the Scan System

To switch on the Scan System, press the Power On/Off Switch on the back of the Scan System to the On (I) position as shown below. Wait for 30 seconds or until a P is displayed on the status LED.

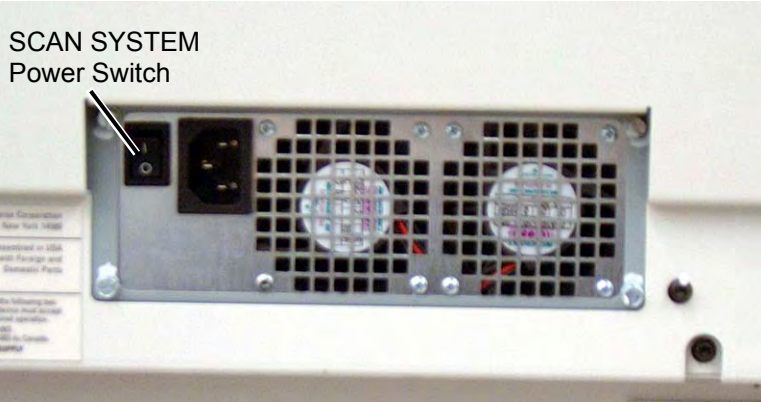

Power Switch for the Scan System

When the Scan System is switched on, the fluorescent lamp inside the Scan System illuminates immediately. If the lamp does not illuminate, refer to the "Problem solving" section of this guide.

**Switching on the
Controller and the Printer
(XEROX WIDE FORMAT
COPY SYSTEM
8825/8830/8850)**

Certain Controllers receive their power from the Printer. They do not have a separate power switch.

NOTE: *Ensure that the Scan System is switched on first and the "P" is displayed in the Status Indicator window.*

To power on these Controllers and the Printer, do the following:

1. Switch the Printer Power Switch to the Off position.
2. Switch the Circuit Breaker Switch to the On position.
3. Switch the Printer Power Switch to the On position.

Switching on the PUN
or YKE Controller and
the Printer (XEROX
WIDE FORMAT
8825/8830/8850/510
Series/721P)

Controller Power Switches

The YKE and the PUN Controller has its own power switch. First power on the Controller, and then power on the Printer.



YKE Controller Power Switch



Power Switch
location on the
PUN Controller

1.

**Switching on the
Printer and the
Controller
(PUN, YKE, and
YKE-N controllers)**

NOTE: Ensure that the Scan System is switched on first and the P is displayed in the Status Indicator window before powering on the Controller.

The PUN controller and the FreeFlow Accxes Print Servers (YKE and YKE-N controllers) each has its own power switch.



Power Switch location on the YKE-N Controller.

When powering them on:

1. Power on the Printer.
2. Power on the Scan System.
3. Wait for the “P” to be displayed in the Status Indicator window of the Scan System.
4. Power on the Controller.

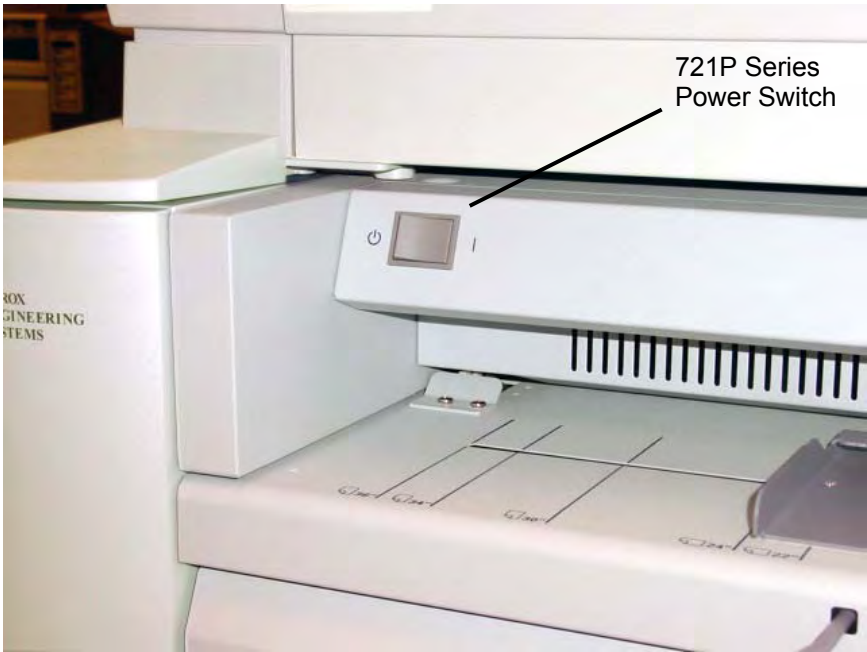
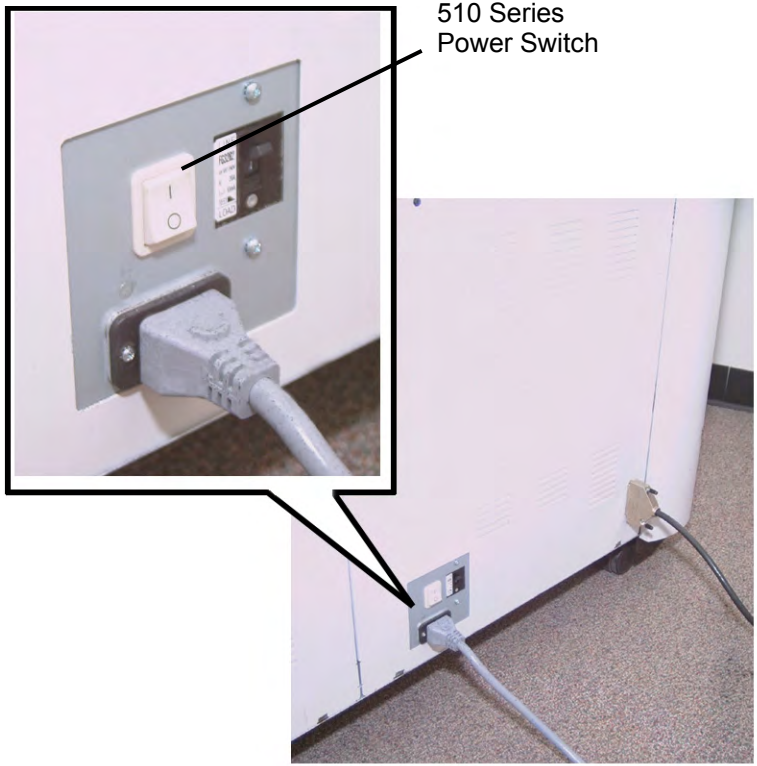



Xerox 6030/6050
Wide Format
Power Switch

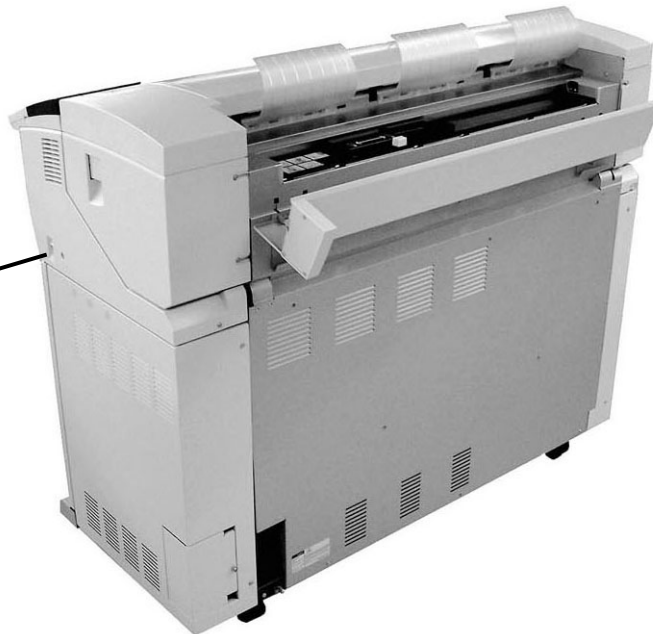

Xerox 6204 Wide Format
Power Switch

Note: *The controller manages
the power supplied to the
Printer or Copier/Printer.*

Powering the Xerox 6204 Wide Format Solution On/Off

The following describes the procedure for powering the Xerox 6204 Wide Format Solution with FreeFlow Accxes Print Server on and off.

Powering On the System

1. Move the printer circuit breaker switch up, to the On [|] position.
2. Move the printer power switch to the On [|] position.

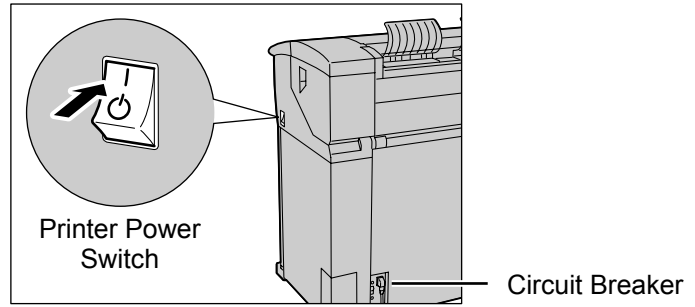

3. Press the power button on the front of the controller.

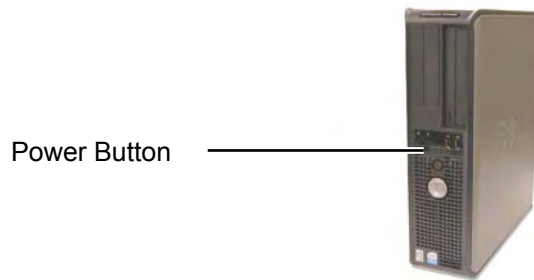

The power button lamp will illuminate. After about one-half minute, the control panel will display the message Printer Warming Up. The machine will be print-ready in about three minutes.



CAUTION *Powering down the system incorrectly may result in data corruption and a service call. The system shutdown procedure below allows the controller to power down correctly. Shutdown is best performed through the Web Print Management Tool or the control panel's System Administration menu's [Shutdown] feature. Only authorized persons should power down the system fully.*

Powering Off the System

1. Ensure that all jobs have finished processing, and that the <Transmitting> indicator on the control panel is not illuminated.
2. Select [Shutdown] from either the control panel or the Web Print Management Tool.

From the control panel

Select the <Log In/Out> button, enter the System Administration password, and then select the [Shutdown] button.

The [Power Off] screen will display briefly on the control panel, and then the control panel and the printer will shut down.

The controller will complete its shutdown within 30 seconds from the moment the control panel and printer shut down. The controller's power button lamp will go out when the controller completes its shutdown.

From the Web Print Management Tool

Select [Utilities] > Shutdown > [Shutdown].

The control panel, printer, and controller will undergo the same power down process as described above.

3. Move the printer power switch to the off position.
4. Move the printer circuit breaker switch to the off position.

The Scan System requires about 45 seconds to warm up and initialize after you power on the WIDE FORMAT COPY SYSTEM. Once the initialization is complete, the READY screen is displayed. Below is an example of the READY screen.

Scan System Warm-up

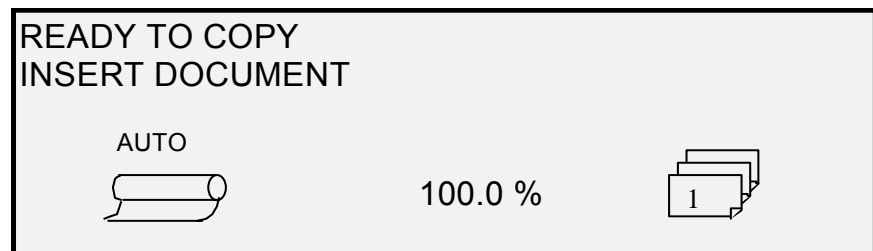

Ready to Copy Screen

You can now insert a document into the Document Feed Tray of the Scan System. The Scan System will then transport the document to the starting position. This transportation of the document is called staging.

If you cannot insert a document into the feed mechanism and achieve staging after approximately 4 minutes, refer to the "Problem solving" section of this guide.

Powering off the System

To power off the WIDE FORMAT COPY SYSTEM, do the following:

1. Power off the Controller and the Printer.
 - For the 8825/8830/8850/510 Series, switch the Circuit Breaker Switch to the Off (O) position. Then switch the Printer Switch to the Off (O) position.
 - For the 721P, first power off the Printer. Then power off the Controller.
2. Switch off the Scan System by pressing the Power On/Off Switch on the back of the Scan System to the Off (O) position as shown below.

SCAN SYSTEM
Power Switch

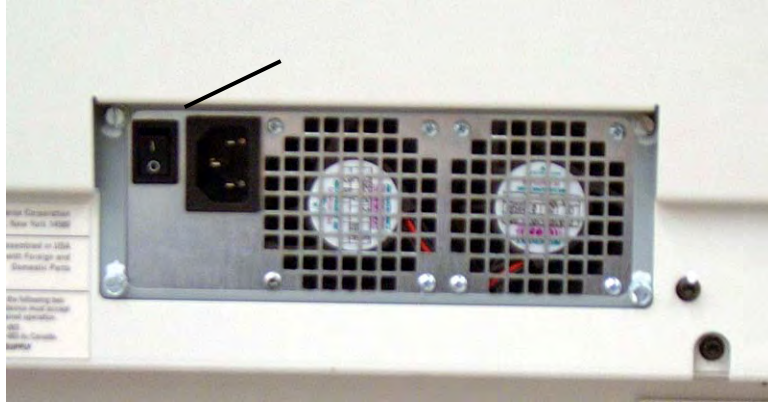

Power On/Off Switch Photo

Document quality

Document quality

Document quality is the primary factor in obtaining good copies from scanned originals. For most documents, the four **Background Suppression** key selections with DYNAMIC BACKGROUND REMOVAL enabled, which is the default setting, provides an accurate copy. Some documents, however, require manual adjustments to the settings.

This section explains the DYNAMIC BACKGROUND REMOVAL feature, describes the characteristics of good quality and bad quality documents, provides tips for preparing and organizing documents for scanning, and summarizes the procedures for scanning documents of different quality types.

Dynamic Background Removal

NOTE: *DYNAMIC BACKGROUND Removal cannot be disabled (unchecked) when using the Productivity mode.*

The DYNAMIC BACKGROUND REMOVAL eliminates the need to make additional manual adjustments for most input documents. Select the Menu key > CONFIGURATION > IMAGE ENHANCEMENT.

This feature allows the system to dynamically adjust itself for each document. There are two modes associated with this feature:

- When DYNAMIC BACKGROUND REMOVAL is enabled, the image is continually monitored as it is being scanned and the copy quality parameters adjusted to achieve the best copy quality.
- When DYNAMIC BACKGROUND REMOVAL is not enabled, the process takes a 0.70 inch (17.8 mm) snapshot over the full width of the image after the first 1.5 inches scan. It uses this fixed area to set the copy parameters for the remainder of the image being scanned. This operating mode should be used for documents with consistent background throughout.

DYNAMIC BACKGROUND REMOVAL only monitors the document in the process direction, from the lead edge to the trail edge. It cannot make adjustment from the left side to the right side of the document. For example, if the input document is dark, DYNAMIC BACKGROUND

Automatic edge detection and document centering

REMOVAL will automatically make the appropriate compensation to optimize the reproduction of the dark details. If the input document has a faded background, the feature will enable a faithful reproduction of the original. However, the faded background must be inserted with the fading running in the process direction with the darker side being inserted first.

In some cases, you may wish to optimize the settings for individual documents. For example, you may not wish to faithfully reproduce paste-up lines, or other artifacts on the original. For this reason, additional controls are available for selection of document type, document image quality, desired output darkness, and background suppression.

The DYNAMIC BACKGROUND REMOVAL feature, when enabled, uses information about the document captured during the scanning process to set image quality settings. The system automatically adjusts for the darkness of the background and the image content throughout the length of the document. When not enabled, it only uses the information in a 0.70 (17.8 mm) area over the width of the document to establish the image quality settings. Therefore, best results can be obtained if the document is fed in with an edge that has a representative sampling of both the background and the foreground image.

The Dynamic Background Removal feature provides an accurate copy for most documents including blue-line, blueprints, color line art/text, and mixed documents containing combinations of halftone and art, or photograph and art. For documents with inverted images, the INVERT function should be enabled. Refer to "Inverting an image" in the "Special features keys" section for instructions on the INVERT function.

The AUTOWIDTH /AUTOCENTER features enable the system to automatically detect the width and center of the document. In cases such as transparencies or translucent documents where automatic detection is not possible, a message will prompt you to enter the width manually. You then must center the document before inserting it into the Scan System.

You can enable/disable the AUTOWIDTH/CENTER feature at any time. Refer to "Scan System Control" in the "Main Menu" section of this manual for more information.

PRODUCTIVITY MODE: This feature became available with version 10.0 FreeFlow Accxes software, and requires a new WIDE FORMAT SCAN SYSTEM with the Productivity Document Feed Tray with the discrete width sensors. This feature measures the document width without doing a pre-scan, requiring the operator to manually align the document within the media size guidelines on the Feed-in Tray. The width sensors eliminate the need for a prescan, thereby increasing the overall throughput of the system, resulting in higher productivity.

When the PRODUCTIVITY MODE is used, the operator must select the media series, ANSI, ARCH, ISO A, CUSTOM, etc., since the number of sensors that can be provided can not monitor every media series. The PRODUCTIVITY mode can be enabled/disabled at anytime. Refer to "Scan System Control" in the "Main Menu" section of this manual for more information.

Determining document quality

Some documents require additional adjustments to obtain the best copy quality. Documents of good quality are easy to scan and usually give good copies on the first attempt. Documents of bad quality may require more than one attempt, using different settings, to obtain the best copy quality.

What is a good quality document?

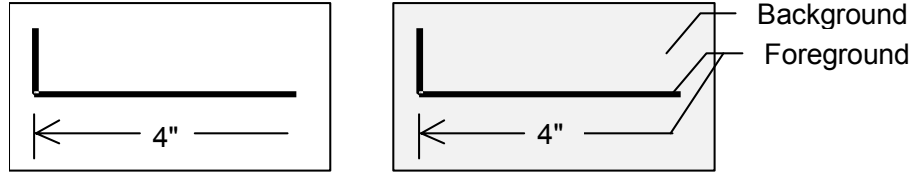

A good quality document has all of these characteristics:

- The contrast between the foreground (the image of interest) and the background is high. The foreground may be color or black.
- The foreground is a solid, high-density black or dark color (or dark blue on a blueline, or dark brown on a sepia). The foreground density is uniform. There is only one kind of foreground (e.g., there are no pencil additions on a blueline). If the document is of mixed type, the foreground is color.
- If the document is white on black or white on blue, the foreground is clear white or nearly white, and the background is a solid, high-density black or dark color.
- The background is white or light-colored and is free of speckling or other noise. The background density is uniform.
- The document has no creases, folds, stains, tears or extraneous marks that the Scan System might interpret as foreground.

What is a bad quality document?

Bad quality documents often require special attention to achieve a usable image. Fortunately, image processing technology is incorporated that can extract acceptable images from documents degraded by many kinds of problems.

A bad quality document has one or more of the following problems:

- The foreground is light (e.g., a faded or overexposed blueprint or light pencil lines).
- The foreground has variable density (i.e., some parts are dark and some parts are light).
- The foreground consists of two or more densities or colors (e.g., pencil additions on an ink drawing, or pencil or ink additions on a sepia).
- The background is medium dark or dark (e.g., underexposed blueprint).
- The background has variable density.
- The background has speckles.

- The document has creases, folds, stains, tears, or extraneous marks that the Scan System might interpret as foreground.

Preparing documents

When preparing documents for scanning, keep the following points in mind:

If documents have been stored rolled up, flatten them out. They will be much easier to handle if they have been stored flat for at least eight hours. The longer that documents have been stored flat, the easier it will be to scan them. Rolled-up documents will typically roll back up after being scanned.

If possible, sort the documents you are going to scan according to these guidelines:

- First, group the documents by media type - bond, vellum or film. Within each document type, you can further group the documents by image type (e.g., blueprint, pencil, sepia, line, photo, mixed (photo and line, blueline and pencil), and so forth).
- Line documents contain lines or text against a highly contrasted background.
- Photo documents are continuous-tone or grayscale images.
- Mixed documents contain both line elements and photo elements or halftone images.
- Scanning groups of documents of the same type or series (ANSI, ARCH, etc.) minimizes the number of changes you will need to make to the **Image Quality** settings.
- Next, divide the documents in each media type group into "good" and "bad" piles based on your evaluation of their foreground and background quality. See "What is a good quality document?" and "What is a bad quality document?" in this section for assistance in doing so.
- By grouping the documents in this way, you can scan the good quality documents first. Then you can focus on the bad quality documents, which will require more attention.
- Next, determine if any of the documents are inverted (i.e., white or light foreground against dark background). If any documents are inverted, refer to "Inverting an image" in the "Special features keys" section.
- Finally, sort the documents by size or series (ANSI, ARCH, etc.). This minimizes the number of times you will need to change the **Media Selection, Output Format** settings when using preset or custom format sizes.

Scanning strategies

When scanning documents, always try the default **Image Quality** settings first. Select the documents type: line, photo, mixed or color and use the **Original, Type, Normal, Line, Photo** or **Color** default settings for that type. **Color** is a Scan-to-Net feature and only available in SCAN mode. These settings have been designed to give the optimum image quality for most documents.

If you have a special original type, you may want to try some of the advanced image processing features available on the Scan System. Table 2 describes the scanning strategies for special original types.

Table 2. Scanning strategies for special documents

Type of original	First step to try	Second step to try	Third step to try
Color photograph	Set Original Type to Photo	Mode Scan: Set Original Type to Color .	Set Original Type to Normal and Background Suppression to Off .
Color lithograph	Mode COPY: Set Original Type to Normal . Mode SCAN: Set Original Type to Color .	Set Original Type to Normal and Background Suppression to Off .	Set Original Type to Photo .
Color map	Mode COPY: Set Original Type to Normal . Mode SCAN: Set Original Type to Color .	Set Original Type to Normal and Background Suppression to Off .	Set Original Type to Photo .
Old blueprint or sepia with dark background	Set Original Type to Line and Background Suppression to Auto . Transform, Invert to ON	Set Original Type to Line , Background Suppression to dark original , Transform, Invert to ON .	Adjust the Copy contrast as required for best image quality.
Old blueprint or sepia with dark background and side-to-side fading	Set Original Type to Line and Background Suppression to Auto .	If fade is still visible in the copy, rotate the original 90 degrees. Generally, feeding the darkest edge first provides the best results.	Adjust the Copy contrast as required for best image quality.
Faded line/text drawing	Set Original Type to Line , Background Suppression to Auto .	If fade is still visible in the copy, rotate the original 90 degrees.	Adjust the Copy contrast as required for best image quality. In reduction, use Reduction Line Preservation.
Line, photo or mixed original on film, clear film, vellum/tracing or other translucent media	Set Background Suppression to (light) and Normal . Select Photo for photo and select Line for line drawing. Use Normal for mixed documents.	Set Background Suppression to OFF .	

Image Quality

The **Image Quality** area of the Scan System Control Panel allows you to make adjustments for both the type of Original document and the output Copy to produce the best possible copy quality. It contains selections for **Original (Document): Type** and **Background Suppression**, and **Copy** options lighter or darker. There is also an IMAGE ENHANCEMENT selection in the **Menu** options that can be used in some copy jobs to improve the image quality. Press the Menu key and scroll to CONFIGURATION > IMAGE ENHANCEMENT.

The illustration below depicts the **Image Quality** portion of the Control Panel.

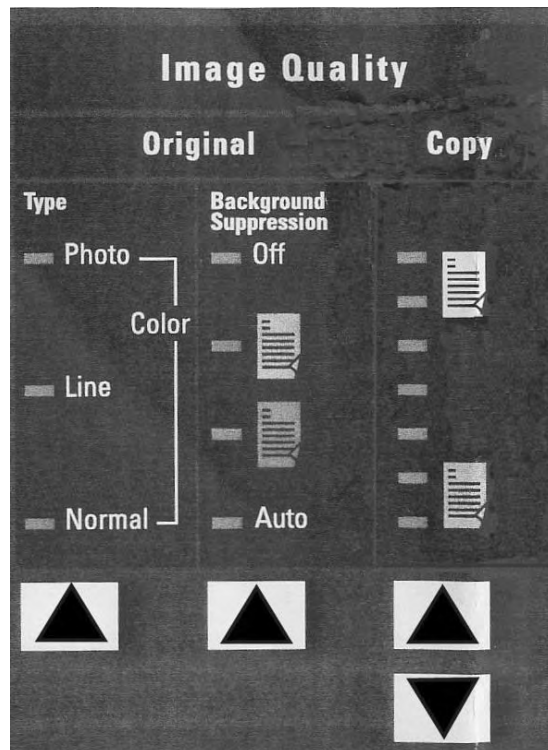

Image Quality Area

Original, Type

Type

The **Type** option allows you to specify the type classification of your document. To select the document type, press the key beneath the **Type** settings until the desired **Type** indicator lamp illuminates.

NOTE: The *SCAN OPTIONS* will not be displayed unless the *Scan-to-Net* feature is installed. To order this feature, contact your XEROX representative.

COPY MODE

**Type, Normal, Line,
Photo,**

The **Type** settings are: **Normal**, **Line**, and **Photo**. **Color** is only available in SCAN mode.

The **Line** mode scans with high contrast to provide exceptional copying of line drawings even light pencil is reproduced as a dark black line.

NOTE: *Line mode should not be used with documents containing half toned images, as this may cause them to become too dark.*

Select **Photo** mode when the document contains a gray scale or color image, such as a photograph.

Normal mode attempts to reproduce the document being scanned to provide the best image quality including halftones and shadings as well as fine lines.

1. Select the **Line**, **Photo** or **Normal** by pressing the arrow key below **Original, Type**.

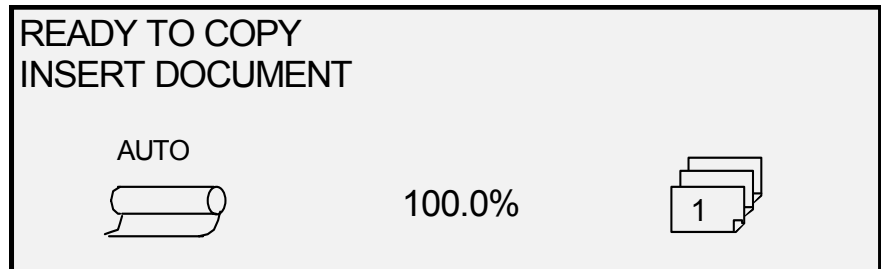

Ready to Copy Screen

Additional image quality settings associated with **Normal**, **Line**, and **Photo** mode can be obtained by using the **Menu** key. Access the IMAGING menu to use the REDUCTION LINE PRESERVATION and the IMAGE ENHANCEMENT menu to use NORMAL MODE and DYNAMIC BACKGROUND REMOVAL.

2. Press the **Menu** key to enter the menu options.
3. Press the **Previous** and **Next** keys to scroll to the CONFIGURATION menu and press the **Enter** key.
4. Use the **Previous** and **Next** keys to scroll to the IMAGE ENHANCEMENT or COPY OPTIONS>IMAGING menu, and then press the **Enter** key.
5. Use **Previous** and **Next** keys to select the option, then press the Enter key to select and enable the settings.

IMAGING	
<input type="checkbox"/>	AUTO-ROTATE
<input checked="" type="checkbox"/>	REDUCTION LINE PRESERVATION
MAXIMUM COPY LENGTH: 1200.0 IN	

Imaging screen

REDUCTION LINE PRESERVATION — Selecting the checkbox will preserve fine lines in the original document when reducing images during copying in **Normal** and **Line** mode only.

MAXIMUM COPY LENGTH – To see what your Scan System's maximum copy length is, select the **Menu key > Configuration > Copy Options > Imaging > Maximum Copy Length**. The default is 100 feet. For the 6030/6050, the scanned copy would get cut off at 3 meters.

WARNING: Copy documents that are larger than the printer's maximum capability will not print correctly, or may not print at all.

IMAGE ENHANCEMENT	
COLOR IQ:	<input type="button" value="SRGB"/>
NORMAL MODE:	<input type="button" value="BEST IQ"/>
<input checked="" type="checkbox"/>	DYNAMIC BACKGROUND REMOVAL

Image Enhancement Screen

NORMAL MODE — BEST IQ provides the best image quality, but it is a slower scanning speed.

FASTEST provides a faster scanning speed with lower image quality. It's only available if the Turbo III Speed Enhancement feature key is installed.

DYNAMIC BACKGROUND REMOVAL —The Dynamic Background Removal feature, when enabled, uses information about the document captured during the scanning process to set image quality settings. The system automatically adjusts for the darkness of the background and the image content throughout the length of the document. Refer to DYNAMIC BACKGROUND REMOVAL in the Document Quality section of this manual for additional information.

SCAN MODE

Type, Normal

NOTE: SCAN mode will not be displayed unless the Scan-to-Net feature is enabled. To order this feature, contact your XEROX representative.

Normal mode attempts to reproduce the document being scanned to provide the best image quality including halftones and shadings as well as fine lines. To select the scan options for **Color** Mode:

1. Press the **Mode** key. The Please Enter Directory screen is displayed.
2. Enter the Directory Name. The READY TO SCAN INSERT DOCUMENT screen is displayed.
3. Select the **Normal** by pressing the arrow key below **Original, Type** key until the **Normal** light comes on. The SCAN OPTIONS (NORMAL) screen is displayed.
4. Use the **Enter** key to enable/disable checkbox selection and the **Next** or **Previous** Key to select options with a colon (e.g., FORMAT: TIFF).

The options available for selections displayed on the screen will change depending on the FORMAT and COMPRESSION that are selected. Listed below are the selections and available options and their definitions:

- PREVIEW - Use this checkbox to enable or disable the generation of a preview image for your scanned document. Default is enabled (checkbox is checked)
- FORMAT - Use this selection to determine which format you would like to have the scanned image saved in, TIFF, CALS (1 BIT only) or PDF. Default is TIFF.

The screen shown below only appears in the SCAN mode. Additional image quality selections are available by pressing the **Menu** key and scrolling to CONFIGURATION>COPY OPTIONS>IMAGING or CONFIGURATION> IMAGE ENHANCEMENT. Refer to the Main Menu section of the manual for additional information on these selections.



Scan Options (Normal) Screen

Type Line

Line — Select **Line** for an image containing text, line art, or a mixture of these. If the COPY mode is selected the READY TO COPY screen will be displayed. If the **Mode** selected is SCAN, and the Scan-to-Net feature key is installed, the SCAN OPTION (LINE) screen will be displayed.

SCAN OPTIONS (LINE)

PREVIEW

FORMAT: ↑↓ TIFF

Scan Options (Line) Screen

1. Select the **Line** by pressing the arrow key below the **Original, Type** key. The **SCAN OPTIONS (LINE)** is displayed.
2. Press the **Previous** or **Next** key to highlight the scan option you wish to change.
3. Select one of the following:
 - **PREVIEW** — Default is enabled and a checkmark is present in the box. Press the **Enter** key to enable/disable the preview. When **PREVIEW** is enabled, a small JPEG (.JPG) file is created during the scanning process and stored on the hard disk. The FreeFlow Accxes Client Tools software, running on a network connected terminal, can use this file to display a preview of the scanned image.
 - **FILE FORMAT** — Default is **TIFF**. Use the **Next** and **Previous** keys to select the format for the document to be saved as. The selection is **TIFF**, **CALS** or **PDF**.
4. Press the **Enter** key to confirm the selection.

Type Photo

Select **Photo** when the document contains a gray scale or color image, such as a photograph. When **Photo** is selected in the Scan Mode, the screen below will be displayed. The screen provides additional options for the user.

SCAN OPTIONS (PHOTO)

PREVIEW

COMPRESSION: ↑↓ RAW

FORMAT: ↑↓ TIFF

Scan Options (Photo) Screen

The **SCAN OPTIONS (PHOTO)** menu allows you to perform the following functions:

- Enable or disable **PREVIEW** in **Photo** mode. When **PREVIEW** is enabled, a small JPEG (.JPG) file is created during the scanning process and stored on the hard disk. The FreeFlow Accxes Client Tools software, running on a network connected terminal, can use this file to display a preview of the scanned image.
- Specify the saved document compression format for **Photo** mode.

- View the saved document file format for **Photo** mode. The format is 8 bit TIFF.

NOTE: This option will not be displayed unless the Scan-to-Net feature is enabled. To order this feature, contact your XEROX representative.

NOTE: The **Background Suppression** option cannot be used with the **Photo** setting. If **Photo** is selected, **Background Suppression** is automatically set to **Off**.

1. Enter the SCAN mode by pressing the **Mode** key, then entering the Directory Name and pressing the **Enter** key.
2. Select **Photo** by pressing the arrow key below **Original, Type** key. The screen shown below is displayed.

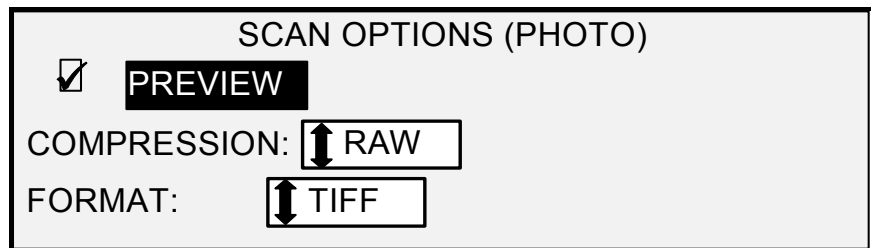

Scan Options (Photo) Screen

3. Press the **Previous** or **Next** key to highlight the scan option you wish to change.

Do one of the following:

- For PREVIEW, press the **Enter** key to enable or disable the option. A checkmark appears in the box to the left of the option when the option is enabled. The factory default setting is enabled.
 - For COMPRESSION, press the **Previous** or **Next** key to highlight the desired setting. Then press the **Enter** key to select the highlighted format. The choices are RAW and PACKBITS. The factory default setting is RAW.
4. For FILE FORMAT, the only selection is TIFF. Repeat steps 3 and 4 to change the remaining setting, if desired.
 5. Press the **Enter** key to confirm the selection.
 6. Press the **Exit** key to return to the Ready screen.

Type, Color

Color — Select **Color** when scanning full color documents. When **Color Type** is selected, a version of the following screens will be displayed. The content of the screen will depend on the selected FORMAT and COMPRESSION.

This screen will only be displayed in SCAN mode when the Scan-to-Net and Color Enablement feature keys are installed. The **Normal** and **Photo** LEDs will be lit when **Color** is selected.

To select the scan options for **Color** Mode:

1. Press the **Mode** key. The Please Enter Directory screen is displayed.

2. Enter the Directory Name. The READY TO SCAN INSERT DOCUMENT screen is displayed.
3. Select the Color by pressing the arrow key below the **Original, Type** key until the Normal and Photo lights come on. The SCAN OPTIONS (COLOR) screen is displayed.
4. Use the **Enter** key to enable/disable checkbox selection and the **Next** or **Previous** Key to select options with a colon (e.g., FORMAT: TIFF).

The options available for selections displayed on the screen will change depending on the FORMAT and COMPRESSION that are selected. Listed below are the selections and available options and their definition:

PREVIEW - Use this checkbox to enable or disable the generation of a preview image for your scanned document. Default is enabled (checkbox is checked)

FORMAT - Use this selection to determine which format you would like to have the scanned image saved in, TIFF or JPEG. Default is TIFF.

COMPRESSION (TIFF selected) - Use this selection to determine the compression method to apply to the saved TIFF document. Select one of the following:

PACKBITS - Saves the document as 24-bit RGB compressed.

INDEX - Saves the document as 8-bit indexed RGB (using thresholding) compressed with PACKBITS.

INDEX ED - Saves the document as 8-bit indexed RGB (using error diffusion) compression with PACKBITS

SCAN OPTIONS (COLOR)

PREVIEW FORMAT:

COMPRESSION:

Scan Options (Color) Screens

SCAN OPTIONS (COLOR)

PREVIEW FORMAT:

COMPRESSION:

PALETTE:

Scan Options (Color) Screen – TIFF file format

PALETTE - Is shown only when the selected FORMAT is TIFF and the COMPRESSION is INDEX or INDEXED. Use this selection to determine which palette to use during RGB-to-index color conversion. Select one of the following:

- DEFAULT - Is the standard Windows system palette.

- CAD_GIS - Is an AutoCAD-based palette suitable for scanning CAD documents and GIS maps.
- WEB - Is a Windows WEB palette of 216 colors suitable for publishing documents on the WEB.
- PERCEPTUAL - Perceptual palette or Visual palette gives more weight to visually sensitive colors.

SCAN OPTIONS (COLOR)

PREVIEW FORMAT:

COMPRESSION:

Scan Options (Color) Screen – JPEG file format

COMPRESSION (JPEG file format selected) - Use this selection to determine the compression method to apply to the saved JPEG document. Select one of the following:

- BEST IQ - Saves a document at a lower compression ratio but has higher image quality.
- NORMAL - Saves a document at an average compression ratio and has average image quality.
- BEST COMPRESSION - Saves a document at a higher compression ratio but has a lower image quality

Background Suppression

The **Background Suppression** enables you to make adjustments for documents that contain poor contrast between the foreground image and the background. **Background Suppression** monitors the pre-scan image, to ensure the best image quality possible. In the PRODUCTIVITY mode, there is no prescan, therefore **Background Suppression** is done while the document is being scanned.

NOTE: *The scan system uses the first few inches of a document to determine the background suppression. If the first few inches of the document being scanned are not representative of the entire document, either too much or too little of the background will be removed. If this occurs, try physically turning the document 90 degrees and scan it again. Continue with this until an edge is found that produces a good scan.*

Four choices are provided:

NOTE: *Off is the only choice for **Photo** and **Color** Scanning. Scanning low contrast documents with background suppression OFF will produce washed out images. When scanning these documents, background suppression should be set to AUTO or DARK.*

Off This setting disables Background Suppression. It produces a document that reproduces all the characteristics of the original document with minimum alteration. Choose this selection when:

- The lead edge of the document is very different from the rest of the document (e.g., the lead edge contains a black border).
- Maps with grayscale or color content may copy best in this mode.
- To retain more light color information such as light gray or yellow.



(Light) This setting works best for documents on translucent or transparent media, such as vellum (tracing paper) or film, or with medium levels of colored background on opaque media or for documents. Such documents have a higher contrast between the foreground and background than dark documents, but less contrast than normal documents.



(Dark) Use this setting for documents with a dark background or with medium contrast between the foreground and background. In this mode, the background is not suppressed, but the foreground image is improved to increase the contrast.

Auto (factory default) - The Scan System automatically adjusts the image quality parameters to obtain the best copy.

NOTE: *All three Background **Suppression** settings can be adjusted further by changing the contrast setting in the **Image Quality, Copy** area.*

Copy

The **Copy** option allows you to darken or lighten the contrast of the copy with respect to the original document. Press the down arrow key to darken the contrast. Press the up arrow key to lighten the contrast. The indicator lamp for the selected contrast setting illuminates. The middle contrast setting is the factory default setting.

You can use this feature to further adjust the effects of the Type and Background Suppression selections. The feature operates with all four Background Suppression modes.

Making copies

Making copies

When the Graphical Display indicates READY TO COPY, the WIDE FORMAT COPY SYSTEM is ready to make copies.

Controlling the scan

Several settings are available for controlling how the Scan System starts and finishes a scan. These settings are accessible from the SCANNER CONTROL option of the CONFIGURATION menu.

SCANNER CONTROL

AUTOSCAN

DOCUMENT RETURN:

MODE:

Scanner Control Screen

When making a copy, you need to be aware of these settings. If any of these settings have been changed from the default settings, the Scan System may not operate according to your expectations.

Below is a brief summary of the scan control settings. For complete information about these settings, refer to “Scan System Control” in the “Main Menu” section of this manual.

AUTOSCAN

AUTOSCAN enabled is the default setting. Normally, the AUTOSCAN mode is enabled. When it is enabled, the Scan System automatically begins the scanning of a document when the document is inserted. If AUTOSCAN is disabled, the Scan System transports the document to the starting position and then waits for you to press the **Start** key before beginning the scan.

DOCUMENT RETURN

FRONT is the default setting. When the DOCUMENT RETURN feature is set to FRONT, the Scan System returns the document to the front or READY position at the completion of the scan. When the DOCUMENT RETURN feature is set to REAR, the Scan System delivers the document to the rear Stacker at the completion of the scan.

Some documents will always exit to the rear at the completion of the scan regardless of the DOCUMENT RETURN setting. These documents include:

- Thick documents
- Documents longer than 5 feet (1.52 meters)
- Documents over 36 inches (914 mm) in width

MODE:

MANUAL - The user must enter the width of the document manually, and very carefully center the document when inserting it into the Scan System. The document is prescanned in this mode.

AUTOWIDTH - This is the default setting. When AUTOWIDTH is selected, the Scan System automatically detects the width of the document.

AUTOWIDTH/AUTOCENTER - The document is prescanned in this mode. When AUTOWIDTH/AUTOCENTER is enabled, the Scan System automatically centers the image and automatically detects the document width.

PRODUCTIVITY – ANSI - PRODUCTIVITY is only available on Scan Systems with FreeFlow Accxes firmware 10.0 or higher, Scan System firmware 3.2.6 or higher, and the Productivity Document Feed Tray that includes discrete width sensors. PRODUCTIVITY – ANSI is the default. Other media type selections include ARCH, ISO A, ISO B, JIS B and CUSTOM. These selections must be made so that the sensors detect the correct width. This feature eliminates the prescan width measurement, which increases document throughput speed resulting in greater productivity. CUSTOM requires standard media sizes to be entered in CUSTOM MEDIA FORMATS.

AUTOWIDTH and AUTOWITH/AUTOCENTER are not available in this mode.

Select the **Menu** key > CONFIGURATION>SCAN SYSTEM CONTROL, MODE: for additional information.

Image Quality

The **Image Quality** area of the Scan System Control Panel allows you to make adjustments for both the type of original document and the output copy to produce the best possible image quality. It contains selections for **Original (Document): Type** and **Background Suppression**, and **Copy** options lighter or darker.

The illustration below depicts the **Image Quality** portion of the Control Panel. Refer to the Image Quality section of this manual for additional information.

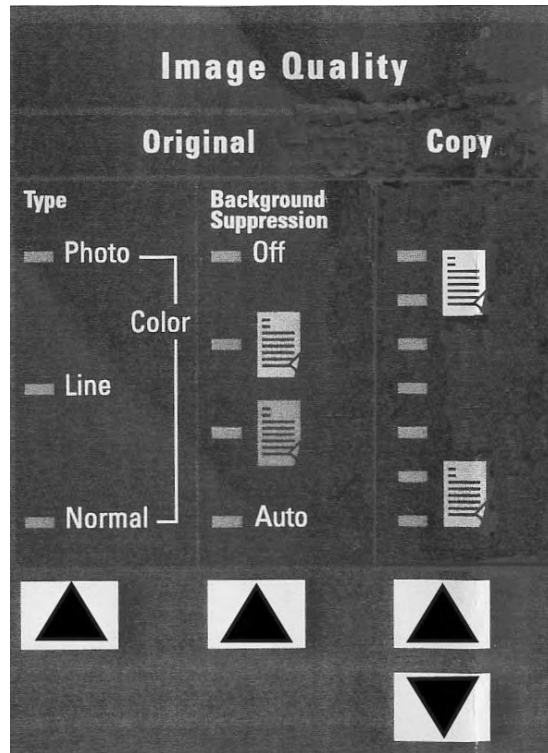

Image Quality Illustration

There are many settings, other than **Media Selection**, **Image Quality** and **Reduce/Enlarge** areas, which are available on the Control Panel. The Transform special features key allows you adjust the margins around the image, specify the position of the image on the media, and transform the image into a mirror and/or inverted. Refer to the applicable sections of this guide for detailed information about the many document settings available to you.

Making a copy with the default settings

When the default document settings are used, the display indicates that the roll of media that best fits the size of the original document will be automatically selected. The reduction/ enlargement setting is 100%, so the copy will be the same size as the original document. The copy quantity is set to 1.

The illustration below shows the READY screen in its default state.

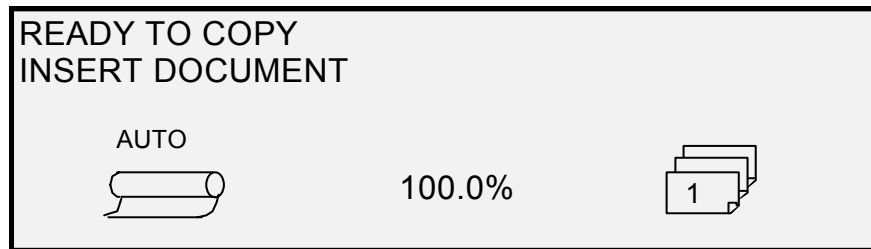

Ready to Copy Screen

NOTE: Many document settings other than the default settings are possible. For example, the options keys on the Scan System Control Panel allow you to control the media selection, image quality and reduction/enlargement percentage. The **Transform** special features key allows you to adjust the margins around the image, specify the position of the image on the media, and transform the image into a mirror and/or inverted image. Refer to the applicable sections of this guide for detailed information about the many document settings available to you.

NOTE: When scanning to print, the copy is made using the current Printer processing defaults including margins. If the image being scanned is the same size as the media being used, set the margins to 0 (zero) to prevent the image from being clipped or select a larger media size.

To make a copy using the default document settings:

1. Insert the original document face down and centered on the Document Feed-in Tray of the Scan System.

NOTE: If the document is not exactly centered and the AUTOCENTER feature is enabled, the Scan System will automatically correct the problem electronically. The resulting image will still be correctly positioned on the output media. If AUTOWIDTH/AUTOCENTER is disabled, you will need to carefully center the document when inserting it. Refer to "Controlling the scan" on the previous page. AUTOWIDTH/AUTOCENTER is not available in the PRODUCTIVITY mode, requiring the user to manually align the document within the appropriate document size guidelines on the Feed-in Tray.

2. Gently move the document forward until the lead edge engages the feed rolls. The Scan System transports the document to the

starting position. It then scans the document. The resulting image is electronically sent to the Printer and your copy is printed.

NOTE: If **AUTOSCAN** is disabled, you will need to press the **Start** key to begin the scan. Refer to “Controlling the scan” on the previous page.

NOTE: If the **PRODUCTIVITY** mode is enabled the document will start scanning immediately. If the **PRODUCTIVITY** mode is not enabled, the document will pre-scan a small distance then reverse itself before starting the complete scan.

3. When the document is returned to the **READY** position, do one of the following:
 - Pull the document to remove it. Lift the Thick Document Lever to remove fragile or thick documents.
 - Press the **Start** key on the Scan System Control Panel to scan the document again.

NOTE: If **DOCUMENT RETURN** is set to **REAR**, the document is delivered to the rear Stacker. Some documents exit to the rear Stacker regardless of the **DOCUMENT RETURN** setting. Refer to “Controlling the scan” on the previous page.

Making a copy the same size as the original document

1. Set the **Media Selection Source** to **Auto**. The **Auto** indicator lamp illuminates. This setting allows the **WIDE FORMAT COPY SYSTEM** to automatically select the available media roll that best fits the image width.

NOTE: If the correct media size is not loaded, the next larger size will be used.

2. Select the **Media Selection, Type**. The default setting is **Bond**.
3. Set the **Media Selection, Output Format** to **Synchro**. This setting cuts the media to the same length as the original document.
4. Set **Reduce/Enlarge** to **Preset**. If the size is not already set to 100%, use the **Previous** and **Next** keys to select a reduction and press the **Enter** key.
5. Insert the document face down into the Scan System. If the scan does not start automatically, press the **Start** key.

NOTE: To set the scan to begin automatically, refer to “Scan System Control” in the “Main Menu” section.

NOTE: If the image needs to be rotated to fit on the selected media size, additional processing time is required. If possible, feed the original

image so that no image rotation is required. This will achieve the fastest processing time. For example, if an A-size copy is required on a 12-inch (30.48 cm) roll, feed the original with the short edge first, not the long edge first. If a B-size copy is required on a 17-inch roll, feed the document with the long edge first, not the short edge first.

The Scan System scans the document and the Printer (if not already busy) prints the copy immediately. If the Printer is busy when the scan is made, the copy will be printed when the Printer becomes available.

When the Scan System detects the trail edge of the document, the Printer automatically cuts the media so that the copy is the same length as the original document.

Fitting the image to a fixed copy size

The scanned image can be automatically fit onto a predefined size of media.

1. Set the **Media Selection, Source** to **Auto**. The **Auto** indicator lamp illuminates. This setting automatically selects the available media roll that best fits the image width.
2. Select the **Media Selection, Type** of media. The default setting is Bond.
3. Set the **Media Selection, Output Format** to **Preset** and select the desired page size. This setting cuts the media to a previously defined length that the operator chooses.

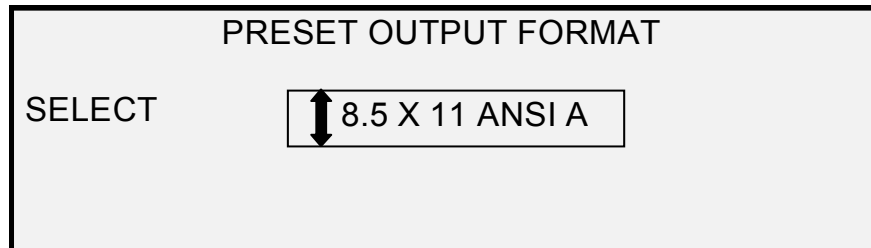

Preset Output Format Screen

4. Press the **Previous** or **Next** key until the desired output size is highlighted.
5. Press the **Enter** key to confirm your choice.
6. Set the **Reduce/Enlarge** to **Auto**.
7. Insert the document face down into the Scan System. If the scan does not start automatically, press the **Start** key.

NOTE: To set the scan to begin automatically, refer to "Scan System Control" in the "Main Menu" section of this manual.

The Scan System scans the document, and the Printer (if not already busy) prints the copy immediately. If the Printer is busy when the scan is made, the copy will be printed when the Printer becomes available.

Scanning when using a Folder

Scanning when using a Folder

When using a Folder, the document must be inserted in the correct orientation in order to have the title block visible after the copy is folded. Refer to the Finisher key information in the Special feature keys section of this manual for additional information to set up the desired fold and other Finisher options. Documents larger than 80 inches (2.1M) can only be partially folded.

When using the **Reduce/Enlarge** feature and a Folder, you must orient and insert the document title block in the same orientation as the resulting enlargement or reduction copy size. In addition, the recommended media should be used.

For example: the job requires that an A (A4) document be enlarged to a C (A2) document. To have the title block visible after folding, the A (A4) document must be inserted as if it were a C (A2) document.

You may want to refer to CUSTOM R/E PRESETS in the Main Menu, COPY OPTIONS section, and set up the REDUCTION/ENLARGEMENT default to show the standard reduction and enlargement. Set the reduction /enlargement to display A to C (A4 to A2) above the keys.

To ensure that the selected fold is made correctly, it is critical that the document be centered on the Scan System Document Feed Tray when scanning.

For additional folding and title block positioning information, refer to the Folder Operator Manual or the Folding Supplement CD.

Ready to Copy Finisher Screen

When the **Finisher** key is pressed and the finishing options are selected, a new page icon is added to the READY TO COPY screen. The page icon is displayed with a dotted box at one of the page corners. The dotted box indicates the title block location selection made using the Finisher menu. The title block location can be changed on this screen using the **Next** and **Previous** keys. Refer to the **Finisher** Key section for additional finishing information. The title block location icon will show a dotted line in all corners when a fold program other than BYPASS is selected.

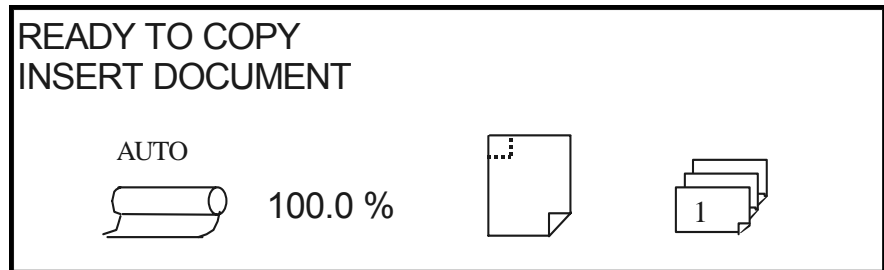

Ready to Copy Screen

NOTE: Any of the finishing options can be changed during a Sets Build job. The option(s) must be changed before the document to be copied is inserted.

Scanning oversized documents

Scanning oversized documents

An oversized document is defined as any document that is larger in width or length than a standard E-size (A0) document.

LONG DOCUMENTS

Operator assistance will be required to guide and control the position of a long document to prevent it from skewing or moving from side-to-side as it feeds through the Scan System. Documents longer than 36 inches (914 mm) will always exit to the rear of the Scan System.

See the Maximum Copy Length section in this document.

WIDE DOCUMENTS

Documents wider than 36 inches (914 mm), but less than 42 inches (1057 mm), can be scanned. However, the scanned image area, of a document centered on the Feed-in Tray, is 36 inches (914 mm). Any image beyond the 36 inch (914 mm) width will be clipped off on the output copy.

When a document wider than 36 inches (914 mm) is inserted into the Document Handler, a message will be displayed to enter the scan width. To scan the document, enter 36 in. (914 mm) then press the Enter key to start the scan. A number larger than 36 (914) will not be accepted.

Special features keys

Special features keys

There are many enhanced features for making copies that meet special needs. The keys that control these features are on the right side of the Scan System Control Panel.

To enable a feature, press the applicable key. If the feature has an associated screen, that screen is displayed when the key is pressed. If any settings are changed from the default state, the corresponding indicator lamp next to the key illuminates. Pressing the C/CA key on the numeric keypad twice returns all settings for the feature to the default state and the corresponding indicator lamp is extinguished.

When the settings for a feature are appropriately set, pressing the same feature key causes the changes to be accepted and the system returns to the READY state. Pressing a different feature key while editing a setting is invalid and causes a beep. Pressing a different feature key while not editing a setting causes the requested feature screen to be displayed.

If a feature has no associated screen, pressing that feature key switches the feature on (enabled) or off (disabled). When such a feature is enabled, the corresponding indicator lamp is illuminated.

If the BEEP function (factory default) is enabled, a beep sound will be heard when a key is pressed. If an improper key is pressed, a multiple beep sound will be heard.

The illustration on the following page depicts the special features portion of the Scan System Control Panel.

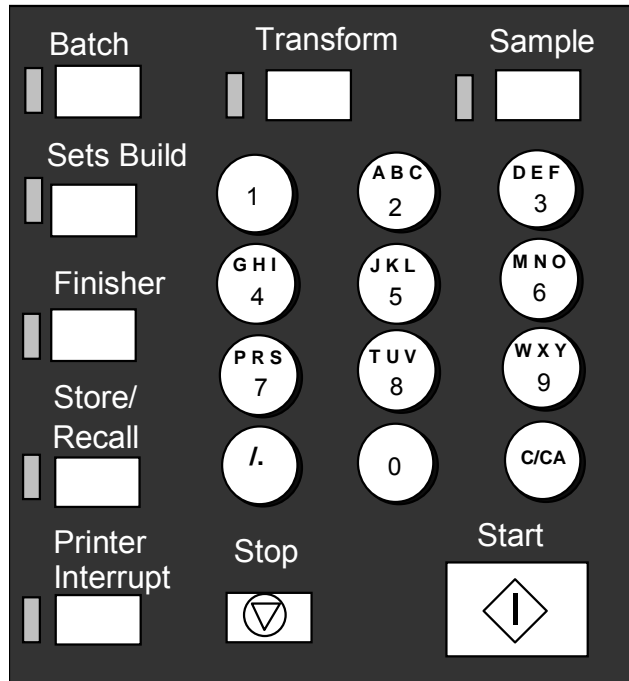

Numeric Keys Area

Printer Interrupt key

Jobs on the WIDE FORMAT COPY SYSTEM have the following priority:

1. Any job currently printing
2. A copy job that is ready to print
3. A remote print job.

If a remote print job is in progress, a copy job (one or more images captured by the Scan System), cannot normally use the Printer until the remote print job has finished. The **Printer Interrupt** key enables you to switch the copy priority from normal to high.

To process a copy job immediately, press the **Printer Interrupt** key. The **Printer Interrupt** indicator lamp illuminates. The current pages of the most current remote print job are completed. Usually a maximum of two pages are printed. The print job is then suspended and you can run copy jobs. When the copy jobs are finished, you can press the **Printer Interrupt** key again. The **Printer Interrupt** indicator lamp is extinguished. The interrupted remote print job resumes.

If you send no more copy jobs, press no keys, and scan no documents, the Printer Interrupt feature is automatically disabled after a time set by the PRINTER INTERRUPT timer. Refer to "Timers" in the "Main Menu, CONFIGURATION" section for instructions about how to set this value. The default value is 1 minute. It can be set to a value between 1 and 99 minutes.

Store/Recall key

The **Store/Recall** feature contains the following menu choices:

- **LAST JOB** - Enables you to recall and reuse the information from the last copy job.
- **JOB TEMPLATES** - Enables you to save the settings from previous jobs in memory as templates.
- **SAVE DEFAULT TEMPLATE** - Enables you to save the settings from the current job as the default template.
- **RECALL FACTORY DEFAULTS** - Enables you to recall the factory default settings as the active default settings.

To access the STORE/RECALL menu:

1. Press the **Store/Recall** key. The STORE/RECALL menu screen is displayed. The black arrows indicate that the menu contains more options than are visible. The selected option is highlighted.



Store/Recall Screen

2. Press the **Previous** or **Next** key to scroll through the list of options.
3. When the desired option is highlighted, press the **Enter** key to select the option. The menu or screen for the selected option is displayed.

Last Job

The **LAST JOB** option of the STORE/RECALL menu provides a sub-menu of the following choices:

- **RECALL LAST JOB** – Enables you to recall and reuse the parameters, images, and features associated with the last copy job. You can either reprint the last job or print a new job using all of the recalled settings. If you desired, the recalled settings could be changed without scanning the job again.

NOTE: When *Immediate Image Overwrite* is enabled on the *Web Print Management Tool*, and is running, all the scanned images and image sets will be deleted from *FreeFlow Accxes* as soon as they are processed. The *FreeFlow Accxes* controller will reboot, causing a “**DISK IMAGE OVERWRITE IN PROGRESS**” message on the printer and scan system during the reboot. *Scan System* users will not be able to recall the last job.

- DELETE LAST JOB – Enables you to delete the information from the last job.

NOTE: In the SCAN mode, the Last Job option is not available.

To access the LAST JOB menu:

1. Press the **Store/Recall** key. The STORE/RECALL menu screen is displayed.
2. Press the **Enter** key to select LAST JOB. The LAST JOB menu screen is displayed. The selected option is highlighted.



Last Job Screen

3. Press the **Previous** or **Next** key to highlight the desired option.
4. Press the **Enter** key to select the highlighted option. The screen for the selected option is displayed.

Recalling the Last Job

Use the RECALL LAST JOB option to recall the information from the last job.

NOTE: If the Invert feature (changes dark to light and vice versa) is selected before printing the recalled document, the document will not be inverted. It will need to be rescanned to get the inverted image.

To recall the last job information:

1. Press the **Store/Recall** key. The Store/Recall menu screen is displayed.
2. Press the **Enter** key to select LAST JOB. The LAST JOB menu screen is displayed.
3. Press the **Enter** key to select RECALL LAST JOB. The screen shown below is displayed.

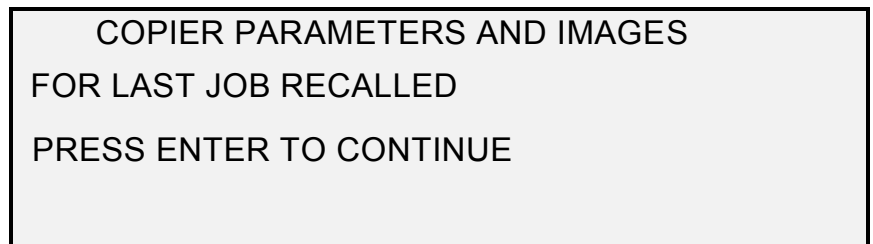

Copier Parameters and Images Screen

4. Press the **Enter** key to return to the READY screen.

You can now use the settings as they have been recalled, or you can change one or more of them.

Reprinting with Changed Features

If the last job was a set, the settings that can be changed are displayed in a neutral state (the LEDs are off). Changing one of these settings will apply to all of the pages in the set. Some of the settings that can be changed are: scale, page size, media type, margins, and justification.

NOTE: The recalled job must be printed or cleared before the next document can be scanned. If there is no last job to be restored, as is the case at power up or after the last job has been deleted, a warning message will advise you.

Deleting the Last Job

If, for security reasons, the parameters and images of the last job should not be left stored, use the DELETE LAST JOB option.

To delete the information from the last job:

1. Press the **Store/Recall** key. The STORE/RECALL menu screen is displayed.
2. Press the **Enter** key to select LAST JOB. The LAST JOB menu screen is displayed.
3. Press the **Next** key to highlight DELETE LAST JOB.
4. Press the **Enter** key to select DELETE LAST JOB. A delete confirmation screen is displayed. The default response is NO.

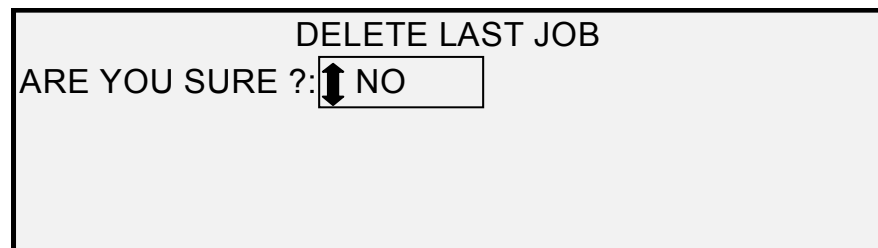

Delete Last Job Screen

5. Press the **Previous** or **Next** key to change the response to YES.
6. Press the **Enter** key to confirm the deletion. The screen shown below is displayed. The last job images and parameters are deleted.

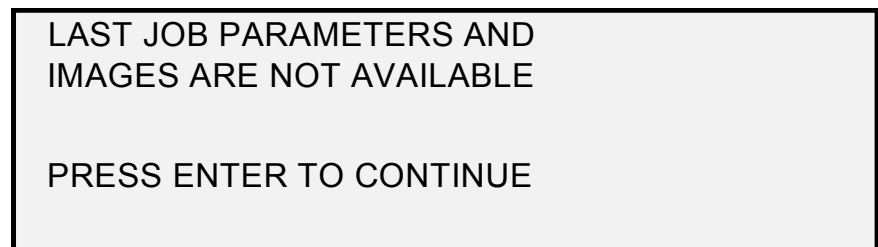

Job Parameters and Images Screen

7. Press the **Enter** key to return to the READY screen.

Job Templates

The JOB TEMPLATES option of the STORE/RECALL menu provides a sub-menu of the following choices:

- RECALL TEMPLATE - Enables you to recall saved settings.
- SAVE TEMPLATE - Enables you to save job settings in memory.
- DELETE TEMPLATE - Enables you to delete saved settings.

To access the JOB TEMPLATES menu:

1. Press the **Store/Recall** key. The STORE/RECALL menu screen is displayed.
2. Press the **Next** key to highlight JOB TEMPLATES.
3. Press the **Enter** key to select JOB TEMPLATES. The JOB TEMPLATES menu screen is displayed. The selected option is highlighted.

JOB TEMPLATES
RECALL TEMPLATE
SAVE TEMPLATE
DELETE TEMPLATE

Job Templates Screen

4. Press the **Previous** or **Next** key to highlight the desired option.
5. Press the **Enter** key to select the highlighted option. The screen for the selected option is displayed.

Saving Job Templates

The SAVE TEMPLATE option allows you to save groups of settings associated with a job in memory as templates. Up to nine such templates can be saved.

To save a job template:

1. Press the **Store/Recall** key. The STORE/RECALL menu screen is displayed.
2. Press the **Next** key to highlight JOB TEMPLATES.
3. Press the **Enter** key to select JOB TEMPLATES. The JOB TEMPLATES menu screen is displayed.
4. Press the **Next** key to highlight SAVE TEMPLATE.
5. Press the **Enter** key to select SAVE TEMPLATE. The SAVE TEMPLATE screen is displayed. It shows the unused template locations. Locations that contain a template already are not shown.

SAVE TEMPLATE
UNUSED TEMPLATES: 6 7 8 9
ENTER TEMPLATE NUMBER: <input type="text" value="0"/>

Save Template Screen

6. Choose an unused location and use the numeric keypad to enter its location.

7. Press the **Enter** key to confirm your location choice. The settings from the current copy job are saved at the location entered and a save confirmation screen is displayed.

JOB PARAMETERS SAVED

PRESS ENTER TO CONTINUE

Job Parameters Saved Screen

NOTE: You can replace the contents of a used location with the current job settings information. If you choose a location that already contains information, the *TEMPLATE IS IN USE* screen is displayed as shown below. Press the **Enter** key to overwrite the contents. Press the **Exit** key to cancel the operation.

TEMPLATE IS IN USE

PRESS ENTER TO OVERWRITE

EXIT TO ABORT

Template is in Use Screen

8. Press the **Enter** key to return to the READY screen.

Recalling Job Templates

The RECALL TEMPLATE option allows you to recall job parameters that were previously saved as templates and use them for the current job.

To recall a template:

1. Press the **Store/ Recall** key. The STORE/RECALL menu screen is displayed.
2. Press the **Next** key to highlight JOB TEMPLATES.
3. Press the **Enter** key to select JOB TEMPLATES. The JOB TEMPLATES menu screen is displayed.
4. Press the **Enter** key to select RECALL TEMPLATE. The RECALL TEMPLATE screen is displayed. The storage locations that actually contain templates are shown. Locations that do not contain a template are not shown.

RECALL TEMPLATE					
TEMPLATES IN USE:	1	2	3	4	5
ENTER TEMPLATE NUMBER		0			

Recall Template Screen

5. Use the numeric keypad to enter the location of the template to be recalled.
6. Press the **Enter** key to confirm your choice. A recall confirmation screen is displayed. The associated template is recalled and the Scan System Control Panel settings are configured accordingly.

JOB PARAMETERS RECALLED
PRESS ENTER TO CONTINUE

Job Parameters Recalled Screen

You can now use the parameter settings as they have been recalled, or you may change some of them.

NOTE: *If you change any of the Image Quality settings (i.e., document type, background suppression, or copy contrast) or if you want to invert the image, an error message will advise you to rescan the image. You must rescan the image to change any image quality settings for a job that has been recalled.*

7. Press the **Enter** key to return to the READY screen.

Deleting Job Templates

Use the DELETE TEMPLATE option to delete previously saved templates. Doing so leaves the template location blank and available to use again. Once a template has been deleted, it cannot be recalled.

To delete a saved template:

1. Press the **Store/Recall** key. The STORE/RECALL menu screen is displayed.
2. Press the **Next** key to highlight JOB TEMPLATES.
3. Press the **Enter** key to select JOB TEMPLATES. The JOB TEMPLATES menu screen is displayed.
4. Press the **Next** key until DELETE TEMPLATE is highlighted.
5. Press the **Enter** key to select DELETE TEMPLATE. The DELETE TEMPLATE screen is displayed. This screen indicates

the locations for the templates currently in use. Locations that do not contain a template are not shown.

Below is an example of the DELETE TEMPLATE screen.

DELETE TEMPLATE
TEMPLATES IN USE: 1 2 3 4 5
ENTER TEMPLATE NUMBER:

Delete Template Screen

6. Use the numeric keypad to enter the location of the template to be deleted, then press the **Enter** key. The deleted location is removed from the list in the DELETE TEMPLATE screen and the contents of that location are deleted.

You can now select other locations to be deleted in the same way.

7. If no more locations are to be deleted, press the **Exit** key to return to the READY screen.

Save Default Template

The SAVE DEFAULT TEMPLATE option of the STORE/RECALL menu enables you to save the settings for the current job as the default settings. Each additional job will then have these settings established as the default selections.

To save the current job settings as the default template:

1. Ensure that all the options under **Media Selection**, **Image Quality**, and **Reduce/Enlarge** are set as desired. Make any necessary changes.
2. Press the **Store/Recall** key. The STORE/RECALL menu screen is displayed.
3. Press the **Next** key until SAVE DEFAULT TEMPLATE is highlighted.
4. Press the **Enter** key to select SAVE DEFAULT TEMPLATE. A confirmation screen is displayed indicating that the job parameters have been saved.

JOB PARAMETERS SAVED

PRESS ENTER TO CONTINUE

Job Parameters Saved Option

5. Press the **Enter** key to return to the READY screen.

Recall Factory Defaults

The factory default job settings are permanently stored in memory. The RECALL FACTORY DEFAULTS option of the STORE/RECALL menu enables you to recall the factory default settings as the active default settings.

To recall the factory default settings:

1. Press the **Store/Recall** key. The STORE/RECALL menu screen is displayed.
2. Press the **Next** key until RECALL FACTORY DEFAULTS is highlighted.
3. Press the **Enter** key to select RECALL FACTORY DEFAULTS. The factory default settings are immediately recalled. A confirmation screen is displayed.

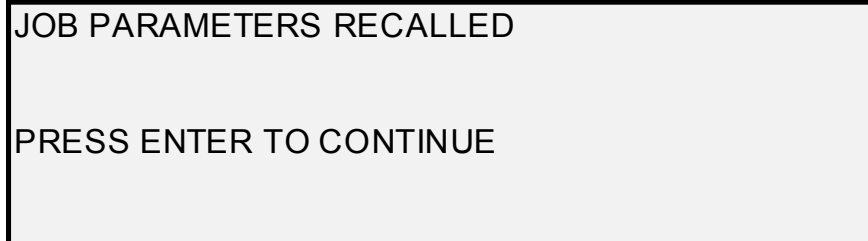

Job Parameters Recalled Screen

4. Press the **Enter** key to return to the READY screen.

Finisher key

A finishing device, such as a folder, can be connected to the WIDE FORMAT COPY SYSTEM. If such a device is connected, the Finisher key enables or disables that device.

To enable/disable a finishing device:

- Press the **Finisher** key. The Finisher indicator lamp illuminates and the FINISHER menu screen is displayed. The black arrows indicate that the menu contains more options than are visible. The selected option is highlighted.

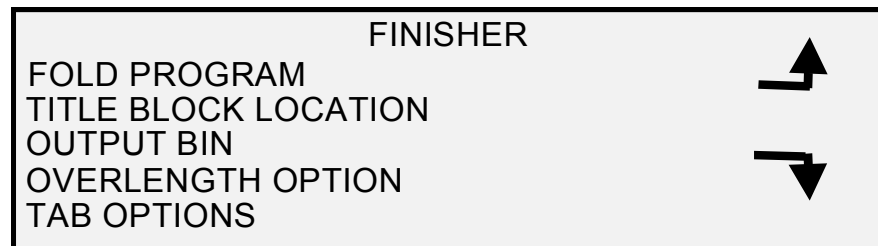

Finisher Screen

Other Finisher options that are accessed from this screen, using the **Next** key, are: Punch Options, Margin Options, Crossfold Options, and Intelligent Title Block Option.

NOTE: If no finishing device is connected, pressing the Finisher key produces the error message shown below.



Finisher Not Available Error Message Screen

When a set is being built, the finisher options cannot be changed and pressing the **Finisher** key is invalid. The error screen shown below is displayed. Enable the finisher and select the finisher options either before selecting the **Sets Build** option or after the set has been built.

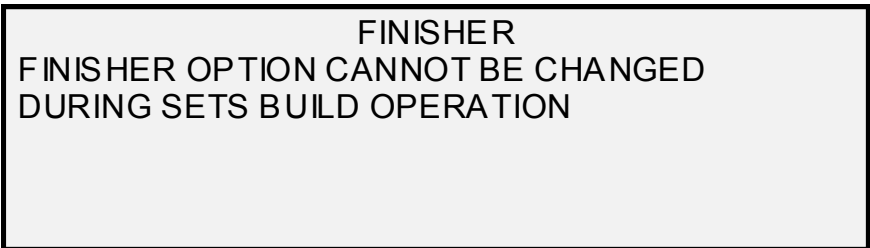

1. Press the **Exit** key to return to the READY screen. The Finisher indicator lamp is extinguished.
2. Press the **Previous** or **Next** key to scroll through the list of options.
3. When the desired option is highlighted, press the **Enter** key to select the option. The screen for the selected option is displayed. See Finisher menu options below and on the next page for an illustration and description of each option. Also refer to the Folder User Documentation for additional information on the available folding options.
4. Press the **Previous** or **Next** key to scroll through the choices for the selected option.
5. When the desired choice is highlighted, press the **Enter** key to confirm your selection.
6. Repeat steps 4 and 5 if you want to change a setting for any other options.
7. Press the **Exit** key to return to the READY screen.

A page icon is displayed with a dotted box at one of the page corners if a FOLD PROGRAM other than BYPASS is selected. The dotted box indicates the title block location selection made using the Finisher menu. The title block location can be changed on this screen using the Next and Previous keys.

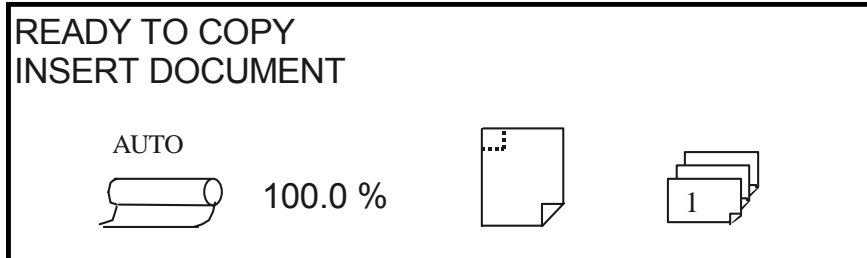

Ready to Copy Screen

1. To disable the finisher, press the Finisher key again and select BYPASS on the FOLD PROGRAM screen. The Finisher indicator lamp is extinguished.

Finisher menu options

Below are descriptions of each of the Finisher menu options. Refer to the Finisher user documentation for additional information on these options.

FOLD PROGRAMS

The FOLD PROGRAM feature enables you to select one of up to 20 user-defined programs. The program names are programmed into the finisher and passed to the Controller when the finisher goes through its power-up sequence.

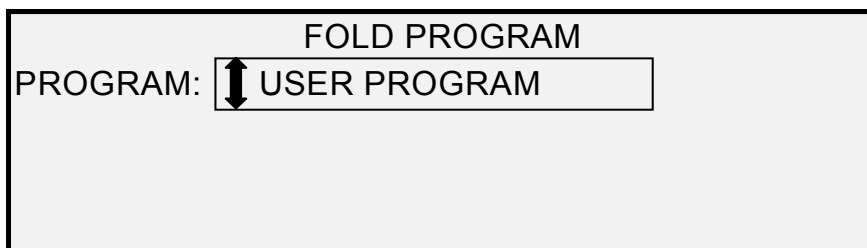

Fold Program Screen

OVERLENGTH OPTIONS

The OVERLENGTH OPTIONS feature enables you to specify how long documents (documents over 80 inches long) are handled by the folder. The choices are NO FOLD and Z-FOLD. If NO FOLD is selected, the long document will not be folded. If Z-FOLD is selected, the long document will be Z-FOLDED, but not cross-folded. NO FOLD is the factory default setting. **This is not available for all finishers.**

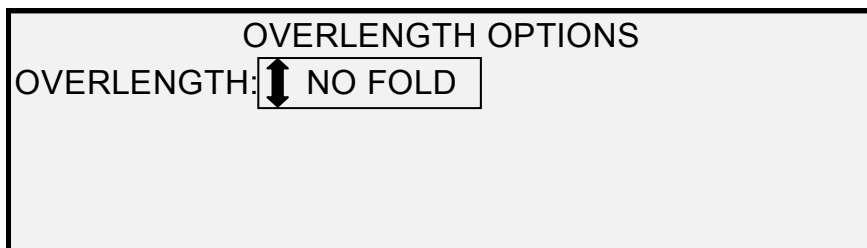

Overlength Options Screen

TAB OPTIONS

The TAB OPTIONS feature enables you to override the pre-programmed tab settings for the selected finishing program. The choices are ALWAYS ON, ALWAYS OFF, and USE PROGRAM SETTING. USE PROGRAM SETTING is the factory default setting.

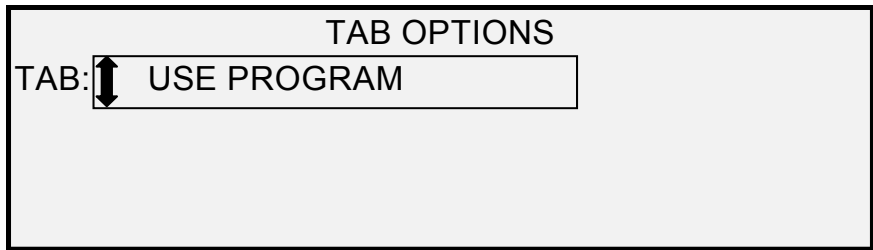

Tab Options Screen

PUNCH OPTIONS

The PUNCH OPTIONS feature enables you to override the pre-programmed hole punch settings for the selected finishing program. The choices are ALWAYS ON, ALWAYS OFF, and USE PROGRAM SETTING. USE PROGRAM SETTING is the factory default setting.

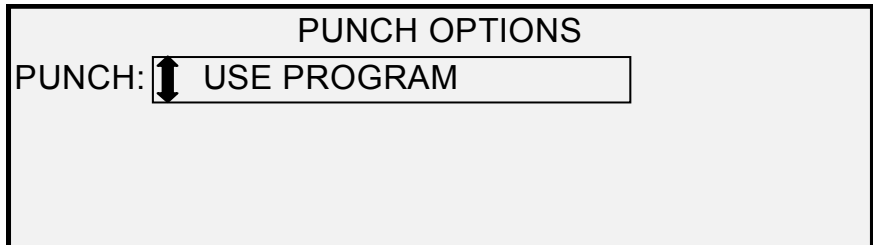

Punch Options Screen

MARGIN OPTIONS

The MARGIN OPTIONS feature enables you to override the pre-programmed margin settings for the selected finishing program. The choices are ALWAYS OFF and USE PROGRAM SETTING. Note that ALWAYS ON is not an available setting. USE PROGRAM SETTING is the factory default setting.

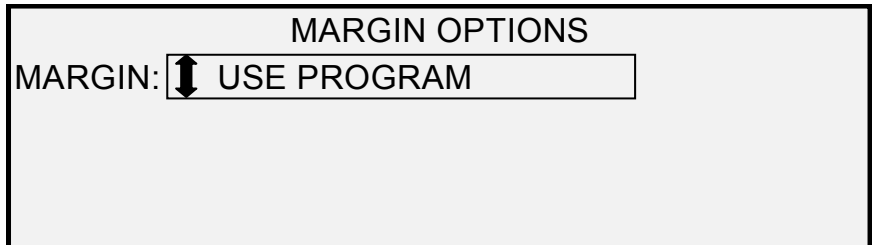

Margin Options Screen

NOTE: When using the Scan System's width detection sensors, if the document is a little bit off-center, this could cause problems for folding, especially for A, B, and C size documents. When using the sensors to detect the width of your document, you must center the document as you feed it into the Scan System.

CROSSFOLD OPTIONS

The CROSSFOLD OPTIONS feature enables you to override the pre-programmed crossfold settings for the selected finishing program. The choices are ALWAYS ON, ALWAYS OFF, and USE PROGRAM SETTING. USE PROGRAM SETTING is the factory default setting.

TITLE BLOCK LOCATION

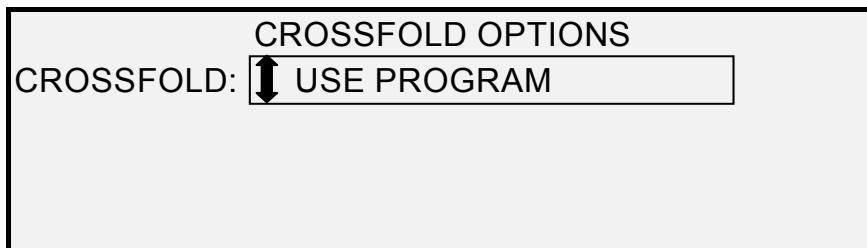

Crossfold Options Screen

The TITLE BLOCK LOCATION feature enables you to specify the location of the title block for the copy jobs that are about to be run. On the Scan System, select the **Finisher Key > Intelligent Title Block** to get to the following screen. The title block location choices are BOTTOM RIGHT, BOTTOM LEFT, TOP RIGHT, TOP LEFT. BOTTOM RIGHT is the factory default setting.

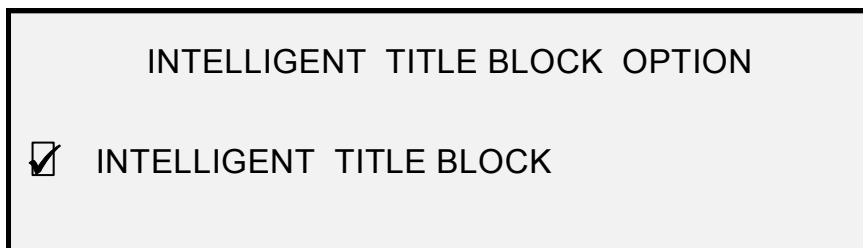

Intelligent Title Block Screen

INTELLIGENT TITLE BLOCK should be used if the title block is not located in the desired location on the folded copy. This selection will use information, document size, selected fold program and title block position input to place the title block in a position based on the information. Intelligent Title Block is DISABLED by default. It may not be the user's desired location. Before making this selection, check the following:

- Auto rotate is selected.
- Document being scanned is oriented correctly for scanning.
- Ensure that the title block position specified is correct.
- For additional help, refer to the Folding Supplement manual.

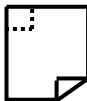

NOTE: The title block location may also be selected on the READY TO COPY screen, using the title block location icon. The title block location is indicated by the dotted lines.

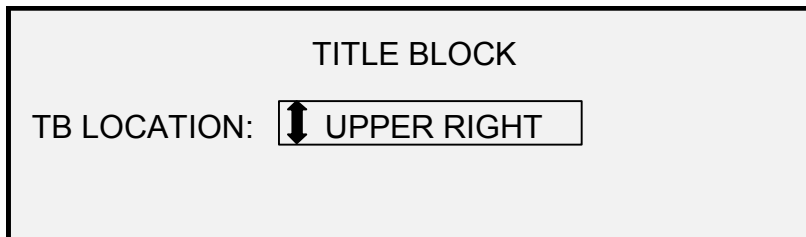

Title Block Location Screen

OUTPUT BIN

The OUTPUT BIN feature enables you to specify which finisher output bin to use for the finished output. The choices are DON'T CARE, BIN X (where X equals 1 to the actual number of finisher bins), FANFOLD.

DON'T CARE is the factory default setting. The settings are dependent on the finisher.

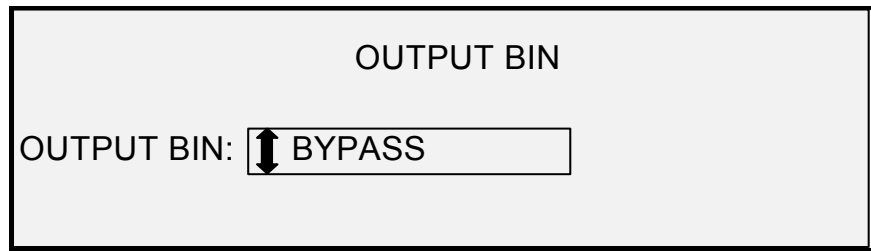

Output Bin Screen

Sets Build key

The **Sets Build** mode allows you to scan a series of images and build an electronically collated set. Once the set is built, one or more collated copies can be printed.

NOTE: The **Sets Build** mode is not available unless the **WIDE FORMAT COPY SYSTEM** is in the **COPY** mode.

NOTE: Any of the finishing options can be changed during a **Sets Build** job. The option(s) must be changed before the document to be copied is inserted.

Preparing to build the set

In **Sets Build** mode, documents of C (A2) size, and larger, are normally delivered to the rear of the Scan System after the scan. If the **DOCUMENT RETURN** parameter is set to **REAR**, then all documents are delivered to the rear after scanning. The **WIDE FORMAT SCAN SYSTEM** is equipped with a document catching device, called the **Stacker**, to receive these documents. Refer to "Scan System Control" in the "Main Menu" section of this manual for further information about the **DOCUMENT RETURN** parameter.

Building and printing the set

To build a collated set:

1. Press the **Sets Build** key. The **Sets Build** indicator lamp illuminates and the **SETS BUILD** screen is displayed. This screen enables you to select the desired collation method, to select whether or not to print checkplots, and to begin the accumulation of the documents to create the set.

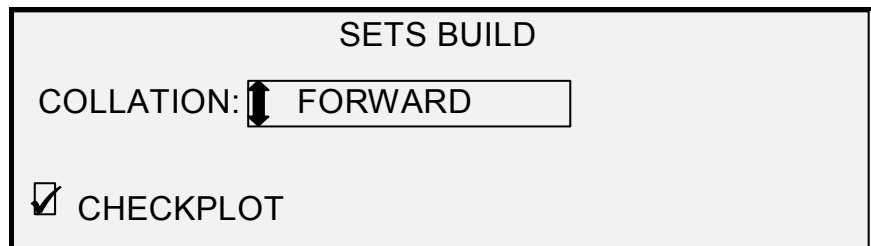

Sets Build Screen

2. Press the **Previous** or the **Next** key to select **FORWARD** or **REVERSE** collation.

- FORWARD prints the collated set in the order that the sheets were scanned. Page 1 will be on the top.



- REVERSE prints the set in the reverse order that they were scanned. Page 1 will be on the bottom.



3. Regardless of the collation order chosen, if you want a printed copy (checkplot) after you scan each document, before they are printed as a set, then select the CHECKPLOT box.
4. Press the **Enter** key to confirm your choice. The READY TO BUILD SET screen is displayed.

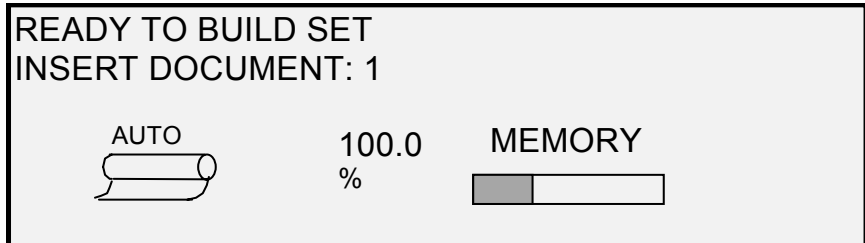

Ready to Build Set Screen

5. Insert each document of the set, one at a time, into the Scan System as prompted by the display. As the documents are scanned, the amount of memory used is shown in the rectangular graphical display.

NOTE: You can select reduction/enlargement and copy quality settings for each sheet prior to scanning that sheet.

6. When the set is completely scanned, press the **Sets Build** key again. The **Sets Build** indicator lamp is extinguished when the **Start** key is pressed then the READY TO PRINT SET screen is displayed.

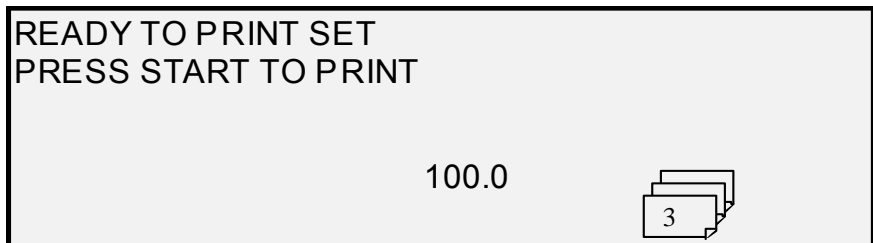

Ready to Print Set Screen

7. If desired, you can now make further changes to the **Media Selection**, **Source** selection and the Reduction/Enlargement

value. Any such change will be applied to that printing of the entire set.

8. Enter the number of copies desired and press the **Start** key. The Printer prints the number of sets requested.

After the printing of the set, the set can be recalled, the values changed again, and the set reprinted using the new values. To recall the set, refer to “Store/Recall key” in the “Special features key” section of this manual for further information.

NOTE: Settings for the last document scanned are not restored when recalling a set. After a set is recalled, all LED's will be turned off. If a setting is changed after a set is recalled, it will be applied to all documents in the set.

Batch key

The **Batch** feature allows you to improve copy speed by enabling **Batch** Mode processing of several documents on the Scan System. When **Batch** Mode processing is enabled, the Scan System collects prescan information for just the first document inserted into the Scan System. Prescan information on subsequent documents in the set is not collected. The subsequent documents will be scanned using the information collected on the first document. Eliminating the collection of this information increases overall copy speed.

To enable Batch Mode processing:

1. Press the **Batch** key. The **Batch** indicator lamp will begin flashing.
2. Insert the first original into the Scan System. The Scan System scans the original and the screen shown below is displayed.

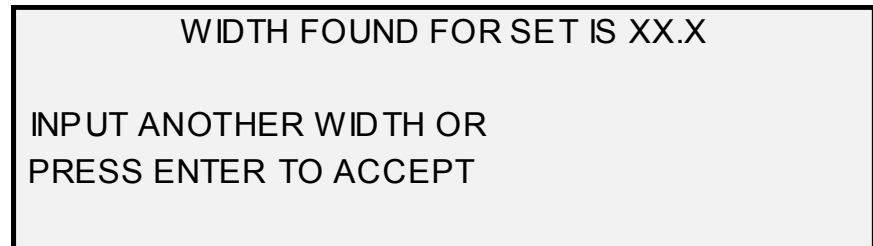

Width Found for Set is XX.X Screen

3. Do one of the following:
 - Use the numeric keypad to enter the width of the set and press the **Enter** key to accept the value.
 - Press the **Enter** key to accept the width detected by the WIDE FORMAT COPY SYSTEM.
 - The Batch indicator lamp becomes steady and remains so until batch mode is disabled.
4. When the last document in the set has been scanned, press the **Batch** key to disable batch mode. The Batch indicator lamp is extinguished.

NOTE: When Batch mode is ENABLED, the AUTOCENTER feature is temporarily disabled. Be careful to manually center each document that is inserted into the Scan System

Transform key

The **Transform** feature contains the following menu choices:

- **MARGINS** - Allows you to adjust the dimensions of the margins around the image. By entering positive margins, blank space is inserted around the image. By entering negative values, unwanted parts of the image can be cropped.
- **JUSTIFICATION** - Allows you to adjust the position of the image on the media.
- **TRANSFORM** - Allows you to request transformation of the scanned image into a mirror image, a negative photographic inversion, or both.

NOTE: The image can also be rotated. Refer to "Imaging" in the "Copy Options" section for further information about image rotation.

To access the TRANSFORM MENU:

1. Press the **Transform** key. The TRANSFORM MENU screen is displayed. The selected option is highlighted.



Transform Menu Screen

2. Press the **Previous** or **Next** key to highlight the desired option.
3. Press the **Enter** key to select the highlighted option. The screen for the selected option is displayed.

Margins

The **MARGINS** option of the TRANSFORM MENU allows you to select the dimensions for the margins that surround an image. These margins are referred to as the lead, left, right and trail edges.

NOTE: Margins can only be adjusted when the WIDE FORMAT COPY SYSTEM is in the COPY mode.

The example below illustrates an image entering the Scan System and the orientation of the image margins.

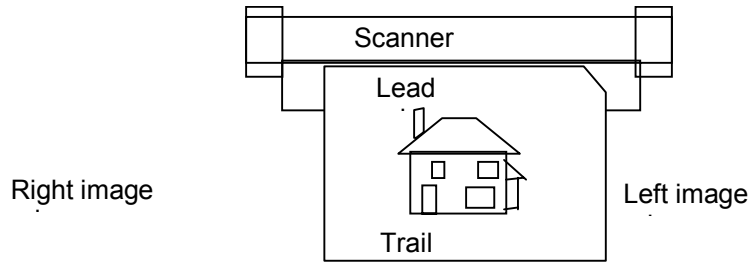

Image Entering the Scan System Diagram

Margins are added to the image in one of two ways:

- If **Synchro** has been selected from the **Output Format** area of the Scan System Control Panel, the lead margin is added before the image is printed. The trail margin is added after the media cut signal is received from the Scan System. Thus, the length of the media from the Printer will be the scanned document length plus the lead and trail margins.
- If a fixed media length (**Preset** or **Manual**) has been selected as the **Output Format**, the white space of the specified margin surrounds the image, but the actual physical dimensions of the media remain as specified. The margins reduce the allowable area on the media in which the image may be placed.

To adjust the margins for an image:

1. Press the **Transform** key. The TRANSFORM MENU screen is displayed.
2. Press the **Enter** key to select MARGINS. A screen displaying the settings for each margin is displayed. Below is an example of the screen.

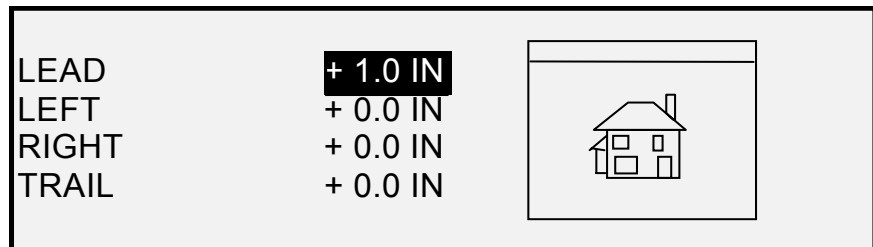

Margins Selection Screen in Transform Menu

If the unit of measure has been set to inches, "IN" appears next to each value. If the unit of measure has been set to millimeters, "MM" appears next to each value. Refer to "Localization" in the "Main CONFIGURATION" section for information about setting the display units.

The graphical display to the right of the margin settings illustrates the approximate placement of the image as a result of the settings.

3. Press the **Previous** or **Next** key to highlight the setting you wish to change.

NOTE: Each margin has two components. They are a "+/-" indicator and a numeric value. As you press the Previous or Next key, the components highlight individually.

4. Press the **Enter** key to select the setting.
5. Change the setting as follows:
 - To change the “+” or “-” setting, press the Previous or Next key. An edge of the image can be clipped by entering a negative margin value for that edge. In that case, the affected edge is shown as a dotted line and the image icon is shown as partially outside the bounds of the media.

The illustration below shows a negative left margin with TOP LEFT justification.



Margins Selection Screen in Transform Menu

- To change the value setting, use the numeric keypad to enter the value. The values can be set in increments of 0.1 in (1.0 mm) and over a range of +8 to -8 in (+203 to -203 mm). Values outside the allowed range are rejected. If you enter an invalid value, press the **Exit** key to clear it. The default margins are 0.
6. Press the **Enter** key to confirm the setting. The graphical display updates accordingly.

NOTE: To cancel the setting, press the **Exit** key.

7. When you have set all the margins as desired, press the **Exit** key to return to the TRANSFORM MENU screen.

Justification

The JUSTIFICATION option of the TRANSFORM MENU allows you to adjust the position of the image on the media.

NOTE: “Image” means the entire scanned page including the white space.

To specify the image position:

1. Press the **Transform** key. The TRANSFORM MENU screen is displayed.
2. Press the **Next** key to highlight JUSTIFICATION.
3. Press the **Enter** key to select JUSTIFICATION. The JUSTIFICATION screen is displayed. This screen shows the current settings for the X and Y coordinates. It also includes a graphical display of the approximate position of the image as a result of the settings.

Below is an example of the JUSTIFICATION screen.

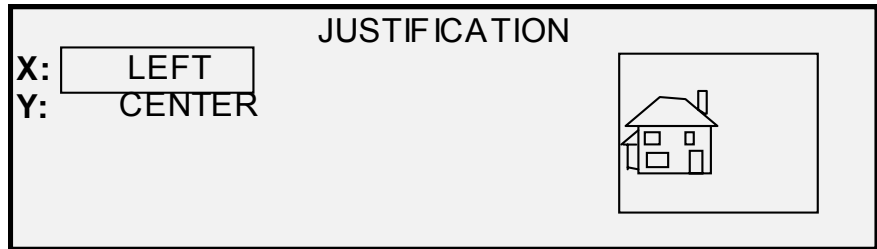

Justification Screen

4. Press the **Previous** or the **Next** key to select the X (horizontal) or Y (vertical) coordinate.
5. Press the **Enter** key to confirm your choice.
6. Press the **Previous** or **Next** key to select a choice for justification.

For the X direction, the choices are LEFT, CENTER, and RIGHT. For the Y direction, the choices are TOP, CENTER, and BOTTOM.

7. Press the **Enter** key to confirm your choice. The graphical display updates accordingly.

NOTE: To cancel your choice, press the **Exit** key.

8. Repeat steps 4 through 7 if you wish to change position of the other coordinate.
9. Press the **Exit** key to return to the TRANSFORM MENU screen.

Transform

The TRANSFORM option of the TRANSFORM MENU allows you to create a mirror image of a scanned image and to convert a scanned image to a negative image.

Creating a Mirror Image

The MIRROR option allows you to create a mirror image of a scanned image.

To create a mirror image:

1. Press the **Transform** key. The TRANSFORM MENU screen is displayed.
2. Press the **Next** key until TRANSFORM is highlighted.
3. Press the **Enter** key to select TRANSFORM. The TRANSFORM screen is displayed.

Below is an example of the TRANSFORM screen with both the MIRROR and INVERT options turned off.

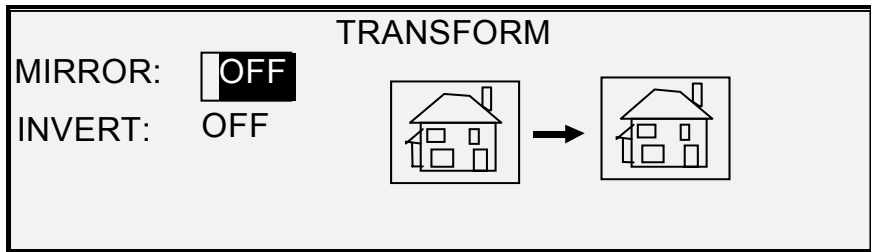

Transform Screen

4. Press the **Enter** key to select MIRROR.
5. Press the **Previous** or **Next** key to select the desired transformation. Four choices are available: X, Y, XY, and OFF. Table 4 below graphically depicts the choices.

Table 4. Mirror transformations

Axis	Transform
X	
Y	
XY	
OFF	

6. Press the **Enter** key to confirm your choice. The graphical display updates accordingly. The illustration below shows the TRANSFORM screen with "X" as the mirror image selection.

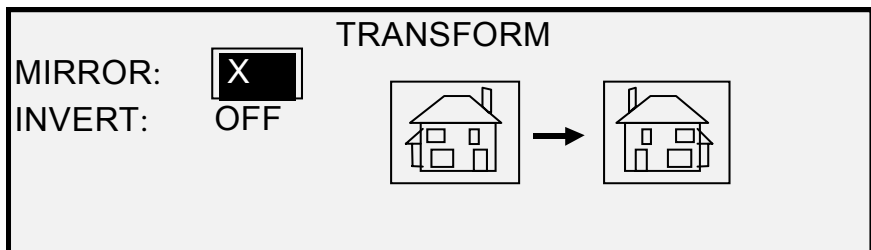

Transform Screen

NOTE: To cancel your choice, press the **Exit** key

7. Press the **Exit** key to return to the READY screen.

Inverting an Image

The INVERT option allows you to convert a scanned image to a negative image. For black and white images, the white pixels will be printed black and the black pixels will be printed white. For grayscale images, the image will be converted into its photographic negative. INVERT is not selectable when **Color** is selected as an **Original, Type**.

To invert an image:

1. Press the **Transform** key. The TRANSFORM MENU screen is displayed.
2. Press the **Next** key until TRANSFORM is highlighted.
3. Press the **Enter** key to select TRANSFORM. The TRANSFORM screen is displayed.

Below is an example of the TRANSFORM screen with both the MIRROR and INVERT options turned off.

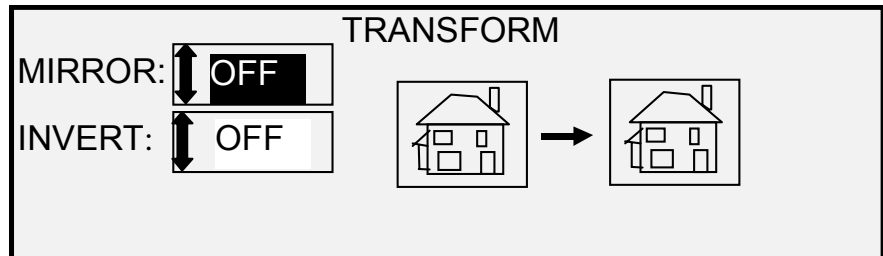

Transform Screen

4. Press the **Next** key to highlight INVERT.
5. Press the **Enter** key to select INVERT.
6. Press the **Previous** or **Next** key to turn the option ON or OFF.
7. Press the **Enter** key to confirm your choice. The graphical display updates accordingly.

When INVERT is ON, the icon on the right side of the TRANSFORM screen is inverted. The example below shows the TRANSFORM screen with INVERT turned ON.

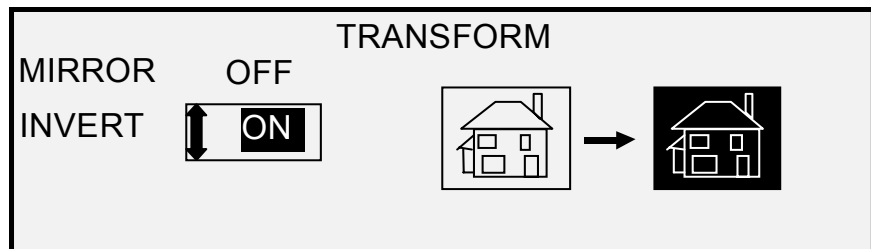

Transform Screen

NOTE: To cancel your choice, press the **Exit** key.

8. Press the **Exit** key to return to the READY screen.

Sample key

The **Sample** key allows you to access the Sample Mode screen, from where you can send a scanned image to an FTP destination.

The Sample key also allows you to print a sample of a scanned image in both the COPY mode and the SCAN mode. You can then check the sample for quality or observe the results of features or copy quality adjustments before the document is copied or scan to a file.

The dimensions of the sample, in the Copy mode, are the width of the page by 210 mm. The sample is taken from a point equidistant from the lead and trail edge of the image. Refer to Copy Mode below for instruction to print a sample.

In the SCAN mode the sample size is the whole document. To enable the **Sample** key in the SCAN Mode, the Scan-to-net feature must be installed. To enable a print sample the Scan-to-Print feature key must be installed. Refer to the Scan Mode Sample below for instructions to print a sample.

Copy Mode Sample:

To print a sample of a scanned image:

1. Press the **Sample** key. The **Sample** indicator lamp illuminates. The Scan System Control Panel is placed in **Printer Interrupt** mode and the **Printer Interrupt** indicator lamp illuminates. The Printer immediately prints a sample of the next image inserted into the Scan System. The SAMPLE MODE screen is displayed.

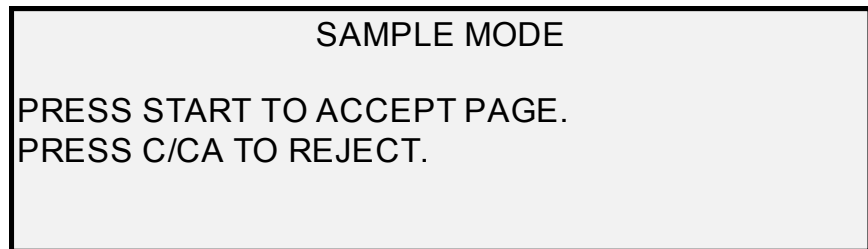

Sample Mode Screen 1

2. Do one of the following:
 - Press the **Start** key to print the complete image as a full-size copy.
 - Press the **C/CA** key to delete the scanned image.
3. Press the **Sample** key again to disable the Sample feature. The Printer is returned to the default priority setting and the **Sample** and **Printer Interrupt** indicator lamps are extinguished.

Scan Mode Sample:

The best sample prints will be produced if the image enhancement features have been enabled. Refer to the Image Quality section of this document for more information.

In order to have the selections indicated below in the SAMPLE MODE screen, the Scan-to-Net feature key must be installed to get SCAN IMAGE TO FILE, and the Scan-to-Print feature key must be installed to get SCAN IMAGE TO PRINTER. It is convenient on the WIDE FORMAT COPY SYSTEMS to be able to make a sample before scanning an image to file.

To print a sample copy, perform the following:

1. If the Scan System is set to COPY mode, switch to SCAN mode. For more information, refer to the section of this document entitled "Switching between COPY mode and SCAN mode".
2. Enter the Directory name.
3. Press the Sample special function key. The SAMPLE MODE screen is displayed.

SAMPLE MODE

FILE: LOCAL FILE

SCAN IMAGE TO PRINTER

Sample Mode Screen 2

NOTE: When there is no Scan-to-Print license present, the FILE field will not be shown. Instead, it will be replaced by the phrase "NO SCAN-TO-NET LICENSE".

The FILE field has the following options to choose from:

LOCAL FILE - Creates a local file on the hard drive.

DESTINATION 1 - FTP file to remote destination 1 configured via Web Print Management Tool "Scan Destinations" page.

DESTINATION 2 - FTP file to remote destination 2 configured via Web Print Management Tool "Scan Destinations" page.

DESTINATION 3 - FTP file to remote destination 1 configured via Web Print Management Tool "Scan Destinations" page.

DESTINATION 4 - FTP file to remote destination 1 configured via Web Print Management Tool "Scan Destinations" page.

NO FILE - Will not leave a file on the hard drive. (Scan-to-Print MUST be enabled when this is selected.)

NOTE: At least one destination must be specified for a file. If you select NO FILE and disable the SCAN IMAGE TO PRINTER checkbox, then you will not be able to exit the screen until either the Scan-to-Print checkbox is selected, or a destination other than NO FILE is selected.

4. Press the **Next** key to highlight SCAN IMAGE TO PRINTER.

NOTE: When there is no Scan-to-Print license present, the SCAN IMAGE TO PRINTER selection field will not be shown. Instead, it will be replaced by the phrase "NO SCAN-TO-PRINT LICENSE".

5. Press the **Enter** key to enable SCAN IMAGE TO PRINTER. Press the **Exit** key to exit the menu.

The processing time for Scan-to-Printer images will be longer, depending on the image size.

Scanning to the Network (SCAN mode)

Scanning to the Network (SCAN mode)

The WIDE FORMAT COPY SYSTEM has two scanning modes of operation: COPY mode and SCAN mode.

NOTE: *The SCAN mode is optional on the XEROX WIDE FORMAT COPY SYSTEM 8825. Color Scan-to-Net is an available option for all XEROX WIDE FORMAT COPY SYSTEMS equipped with the WIDE FORMAT SCAN SYSTEM. The Color Scan-to-Net feature requires a separately purchased, Color Enablement feature key.*

NOTE: *The COPY mode will be disabled and the READY TO COPY screen will not be accessible when the SCAN OPTION (COLOR) is enabled and a color printer is connected to the Controller.*

- In COPY mode, documents are scanned and temporarily stored in memory or on the controller internal hard disk, and then sent to the local Printer as soon as the Printer is available. When the next job is scanned, the file from the previous job is automatically deleted from the hard disk, making room for new files. Operation of the system works as described in the previous sections.
- In SCAN mode, there are two choices:
 - Scan-to-FTP:** This is a security feature to allow scanned images to be sent to 4 remote FTP destinations. Before an image is scanned, the FTP Destination is selected on the Scan System's Sample Mode screen. The scanned image data will not be left on the FreeFlow Accxes disk, as they are with Scan-to-Net images. The FTP Destinations were defined on the Web Print Management Tool page located at Printer Defaults > Utilities > Scan Destinations. See the Sample Mode section of this document for details.

If an internal error occurs while FTP transferring a scanned image to a remote file system, the scanned image will be deleted and the following error will be displayed. Setting up an FTP destination on the Web Print Management Tool with an invalid user name and/or password, can also cause this error.

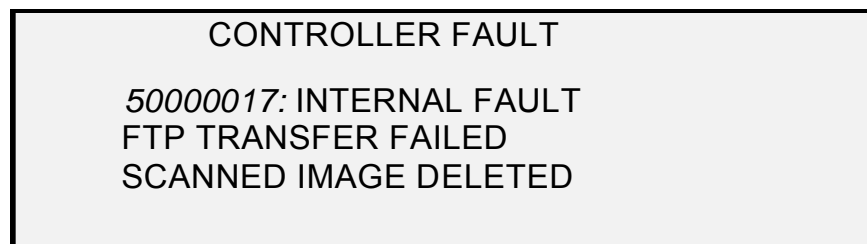

FTP Transfer Failed Screen

Scan-to-Net: The image file created by scanning is stored directly on the controller hard disk for later retrieval over a connected network by a remote system. The image is stored in Tagged Image File Format (TIFF) 6.0 using CCITT Group 4, CALS, Packbits, or PDF. High resolution JPG files are also available with the Color Scan-to-Net option. Files stored in SCAN mode can be retrieved over the network. After the FreeFlow Accxes Client Tools program, which is running on a network-connected computer, retrieves the file, the image residing on the local hard disk is deleted automatically.

After a file has been on the local hard disk for longer than the time specified for the FILE DELETION Timer, the system automatically deletes the file. Refer to the Main Menu, CONFIGURATION menu, TIMERS section of this manual for information about setting the FILE DELETION timer.

Switching between COPY mode and SCAN mode

NOTE: *The COPY mode will be disabled and the READY TO COPY screen will not be accessible when a color printer is connected to the Controller.*

To switch between the COPY mode and the SCAN mode, perform the following steps:

1. Ensure that the READY TO COPY screen is displayed. If a menu is displayed, press the **Menu** key to return to the READY screen. If PLEASE ENTER ACCOUNT is displayed, enter a valid User ID code, then enter a valid account number to obtain the READY screen.
2. Press the **Mode** key. The system switches to the SCAN mode and the screen now displays. Pressing the **Mode** key again returns the system to the COPY mode.

PLEASE ENTER
DIRECTORY

Images

Please Enter Directory Screen

3. Enter a Directory name, up to 16 alphanumeric characters, to which you will scan the images. The name cannot begin with a period/decimal point.

Understanding the READY TO SCAN screen

Below is an example of the READY TO SCAN screen. Following the example are descriptions of the special information displayed on the screen.

READY TO SCAN
INSERT DOCUMENT

TIFF/CCITTG4
1 BIT

400

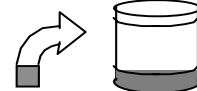

Ready to Scan Screen

TIFF/CCITTG
41 BIT

This area indicates the selected file format. Refer to SCAN OPTIONS (LINE) or SCAN OPTIONS (PHOTO) or SCAN OPTIONS (COLOR) to set these options. The available options will differ depending upon your Scan Option selection.

400 DPI

This area shows the selected scanning resolution. Press the Previous or Next key to select a value of 100, 200, 300, or 400 DPI (Dots Per Inch). A new value can be selected before each scan.



This icon shows how much Random Access Memory (RAM) is in use by the scanned file. As space is used, the dark area increases. After the scan is complete, the file is processed and then moved to the internal hard disk. The RAM space then becomes available again.



This icon shows how much hard disk space is in use by stored files. As space is used, the dark area increases. When files are moved off the disk over the network to remote devices, the space becomes available again. Files

are also deleted when the age of the file exceeds the value set in the timer. Refer to “Timers” in the “Main Menu” section to set this value. The factory default is 24 hours.

Selections disabled in SCAN mode

Certain selections available in COPY mode are not available in SCAN mode. The unavailable selections are:

- **Sets Build** - In Scan-to-Net mode each document has a separate image stored on the disk. Scan-to-FTP images are not stored on the disk. Each image is separately retrieved at the remote device. Images cannot be grouped in sets.
- Specifying the media **Source** and **Type** – Since the output is now an electronic file, specifying the media is not applicable.
- Specifying the output format – The image file always has the format of the length of the document by the scan width. The scan width can be manually specified if the entire width of the document is not desired. Refer to “Scan System Control” in the “Main Menu” section to enable or disable manual specification of the scan width.
- Selection of Margins or Justification – You can crop equal amounts from each side edge of the document by manually specifying a scan width that is narrower than the actual document. Refer to “Scan System Control” in the “Main Menu” section to enable or disable manual specification of the scan width.
- Specification of Finishing Options – Since there is no physical output, the finishing operations are not applicable.
- Selection of **Reduce/Enlarge** - The electronic file is saved without alteration, so all scanned information is preserved.
- Selection of Image **Type**. Only **Line**, **Photo**, **Normal**, and **Color** image types are valid for SCAN mode. Refer to the “Image Quality”, “Scan Mode” section in this manual for additional information
- **Background Suppression** - This selection is automatically switched to OFF if a color printer is connected.

Operating in SCAN mode

To scan documents for later retrieval over the network:

1. If job accounting is enabled, enter in your User ID and Account ID when prompted and press **Enter**. If job accounting is not enabled, you will not have to enter your IDs.
2. If you want to see a preview of the scanned images when they are retrieved from the Controller to your workstation, verify that the Scan System’s default “PREVIEW” box is checked when selecting the **Original**, **Type**. Use the **Previous**, **Next**, and **Enter** keys to enable PREVIEW. Use the **Enter** key to confirm your choice(s).

3. With READY TO COPY is displayed on the Scan System Control Panel, press the **Mode** key to display READY TO SCAN.
4. Use the keypad on the Scan System Control Panel to enter in your 16 alphanumeric character Scan Directory name.
5. To view a sample of the file before it is scanned to a file, press the **Sample** key on the Control Panel. Use the **Next** or **Previous** key to highlight SCAN-TO-PRINTER and press the **Enter** key. Press the **Exit** key to return to the READY screen, then press **Start**. A copy will be sent to the printer.
6. When the Scan System Control Panel displays READY TO SCAN, select your desired scanning resolution using the **Next** and **Previous** keys.

NOTE: When making a color scan, be sure to select **Color** with the arrow key under **Image Quality** on the Scan System Control Panel. The Normal and **Photo** lights will be on.

7. Select the **Image Quality, Original, Type** by pressing the arrow button located under **Type**. When the **Type (Normal, Line, Photo, or Color)** is selected, the appropriate SCAN OPTION (NORMAL, LINE, PHOTO, or COLOR) is displayed. Use the **Next, Previous, and Enter** keys to navigate to and through the available options on the screen. Press the **Enter** key to confirm your choice(s). For additional information refer to the "Image Quality, Scan Mode" section of this manual.
8. Insert your original document face down and centered on the feed tray of the Scan System.
9. Gently move your document forward until the Scan System's feed rolls engage the document's leading edge.
10. If prompted to do so, enter the desired scanning width and press **Enter**.
11. As your document is automatically fed into the Scan System, the resulting image is stored as a file in the Scan Directory on the system Controller's hard drive. The image can be retrieved at your workstation using the Document Retrieve Tool of the FreeFlow Accxes Client Tools.

NOTE: You may have to press the **Start** button if the configuration (for Auto Scan) has been changed from the factory default.

Clearing the scanned images

The **C/CA** key enables you to remove scanned images from the WIDE FORMAT COPY SYSTEM hard disk.

To clear scanned images:

1. Press the **C/CA** key. The CLEAR SCANNED IMAGE screen is displayed.

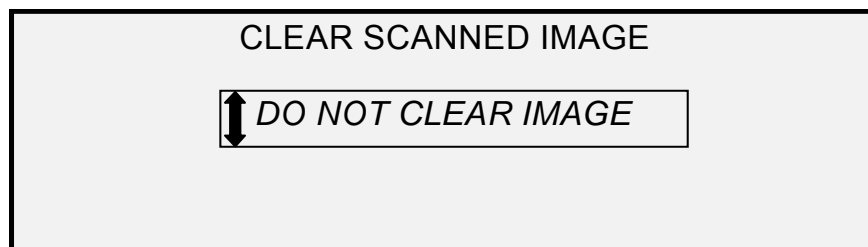

Clear Scanned Image Screen

2. Press the **Previous** or **Next** key to highlight the desired selection.
3. Press the **Enter** key to select the highlighted selection. The choices are:

DO NOT CLEAR IMAGE – The image is not deleted.

CLEAR LAST IMAGE - The last image scanned by the currently active account is deleted. Press the **C/CA** key again, followed by the **Enter** key, to delete the next-to-last scanned image. This process can be repeated until all desired images are removed from the hard disk. It may take a few minutes longer to clear a scanned photo or an image with color.

NOTE: *It is not possible to skip images. For example, it is not possible to leave the last image scanned, but delete the next-to-last image scanned. **Photo** and **Color** mode scans may take a few minutes to clear.*

CLEAR ALL IMAGES – All images stored under the currently active account are deleted.

Managing the file system

The file system stores images in directories on the internal hard disk drive. The images are stored in the Directory specified by the user when entering the SCAN mode. The default directory is “images”. Managing the file system requires the System Administrator password.

The FILE SYSTEM option of the SYSTEM ADMINISTRATION menu enables the System Administrator to perform a number of file system management functions. They are:

- Listing the number of images stored under each directory and the percentage of total hard disk space consumed by each account
- Deleting all of the images scanned under any directory.

- Deleting all of the images currently stored on the hard disk.

Refer to “File System” in the “Main Menu” section of this manual for complete information about the above functions.

Main Menu

Main Menu

The Main Menu provides options for configuring the system, obtaining system information, performing system administration functions, and running system diagnostics.

When you access the Main Menu, a menu containing the following sub-menus is displayed:

- **CONFIGURATION** - Enables you to configure the settings for a variety of system options. These include localization, the Scan System Control Panel, copy options, scan options for Normal, Line and Photo modes (and Color, if enabled), timers, the power saver timeout, and Scan System control for Copy and Scan modes.
- **SYSTEM INFORMATION** - Enables you to obtain information about the system components, display the Scan System fault list, print configuration pages, and view user account information.
- **SYSTEM ADMINISTRATION** - Enables the system administrator to perform job accounting, file system management, security, and change password functions. Access to this menu requires an administrator's password.
- **DIAGNOSTICS** - Enables the Customer Service Engineer and/or the operator to run a number of system diagnostic routines.

To access the Main **Menu**:

1. Press the **Menu** key.

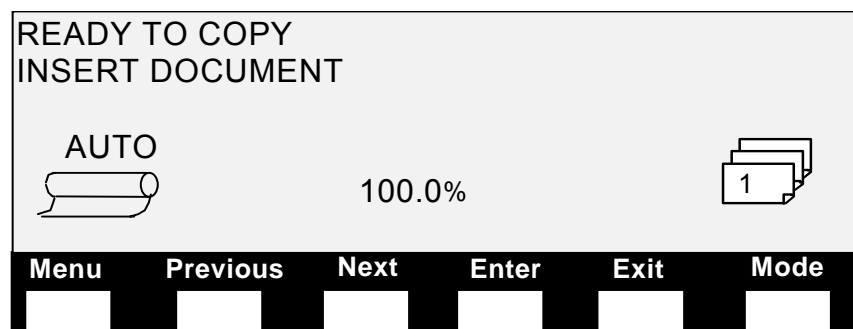

Ready to Copy Screen

The MAIN MENU screen is displayed. The black arrows indicate that the menu list contains more items than are visible. The selected option is highlighted.

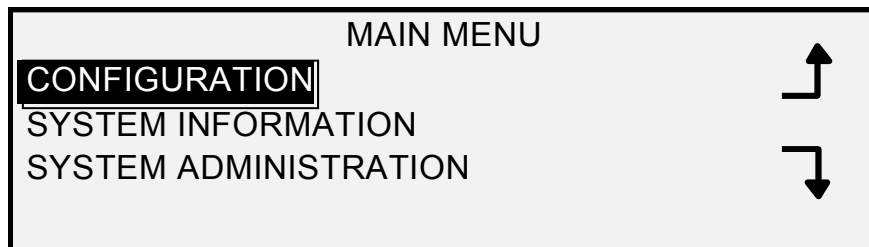

Main Menu Screen

2. Press the **Previous** or **Next** key to scroll through the list options.
3. When the desired option is highlighted, press the **Enter** key to select the option.

Configuration menu

The CONFIGURATION option of the Main Menu provides a sub-menu of the following choices:

- LOCALIZATION - Sets the display language and units of measurements.
- CONTROL PANEL - Controls whether the beeper is used for the key click and invalid entry beeps. Also allows selection of the font display style and the default operating mode.
- COPY OPTIONS - Sets the choices for standard media series, custom media formats, custom reduction/enlargement values, and imaging parameters.
- IMAGE ENHANCEMENTS - Enhances the appearance of a color scanned images in particular color halftones, Scanning speed BEST IQ and FASTEST, and Dynamic Background Removal. The FASTEST selections requires the Turbo III.
- TIMERS - Sets the values for the Feature, Printer Interrupt, and File Deletion timers.
- POWER SAVER - Sets the number of hours of inactivity after which the system goes into Power Saver mode.
- SCANNER CONTROL - Sets the choices for the operation of the Scan System for both copying and scan-to-file. Auto Scan, Document Return, and Mode (Manual Width, Auto Width).

To access the CONFIGURATION menu:

1. Press the **Menu** key. The MAIN MENU screen is displayed.
2. Press the **Enter** key to select CONFIGURATION. The CONFIGURATION menu screen is displayed. The black arrows indicate the menu contains more options than are visible. The selected option is highlighted.

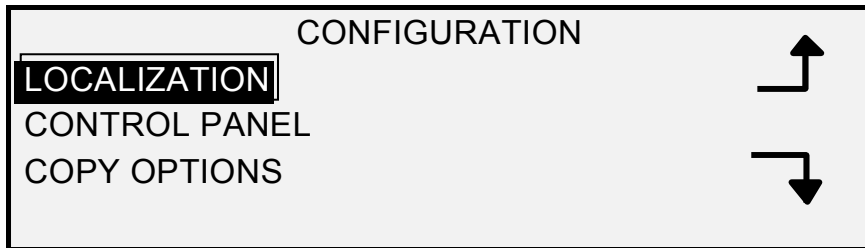

Configuration Screen

3. Press the **Previous** or **Next** key to scroll through the list of options.
4. When the desired option is highlighted, press the **Enter** key to select the options. The menu or screen for the selected option is displayed.

LOCALIZATION

The LOCALIZATION option of the CONFIGURATION menu sets the language in which messages are displayed. It also controls whether measurements are displayed in English or metric units.

To set the display language or display units:

1. Press the **Menu** key. The MAIN MENU screen is displayed.
2. Press the **Enter** key to select CONFIGURATION. The CONFIGURATION menu screen is displayed.
3. Press the **Enter** key to select LOCALIZATION. The LOCALIZATION screen is displayed. Below is an example of the LOCALIZATION screen.

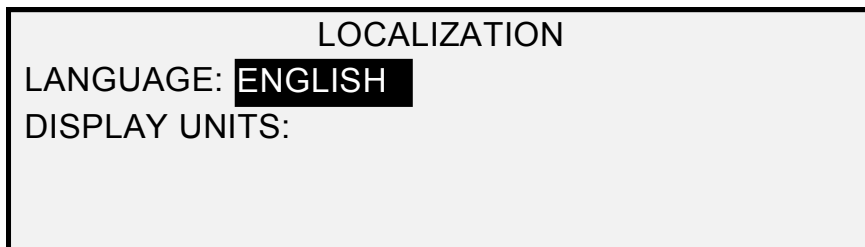

Localization Screen

4. Press the **Previous** or **Next** key to highlight LANGUAGE or DISPLAY UNITS.
5. Press the **Enter** key to select the highlighted option.
6. Press the **Previous** or **Next** key to highlight the desired setting for the option.

The choices for LANGUAGE are ENGLISH, SPANISH, FRENCH, ITALIAN, GERMAN, RUSSIAN, or PORTUGUESE. ENGLISH is the default setting.

The choices for DISPLAY UNITS are INCHES or MM (MILLIMETERS). INCHES is the default setting.

7. Press the **Enter** key to select the highlighted setting.
8. Repeat steps 4 through 6 to change the remaining setting, if desired.
9. Press the **Exit** key to return to the CONFIGURATION menu screen.

CONTROL PANEL

The CONTROL PANEL option of the CONFIGURATION menu controls whether the beeper is used for the key click and invalid entry beeps. It also allows selection of the font display style and the default mode of operation for the WIDE FORMAT COPY SYSTEM.

To set the beeper, text style or default operating mode:

1. Press the **Menu** key. The MAIN MENU screen is displayed.
2. Press the **Enter** key to select CONFIGURATION. The CONFIGURATION menu screen is displayed.
3. Press the **Next** key to select CONTROL PANEL.
4. Press the **Enter** key to select CONTROL PANEL. The CONTROL PANEL screen is displayed. Below is an example of the CONTROL PANEL screen.

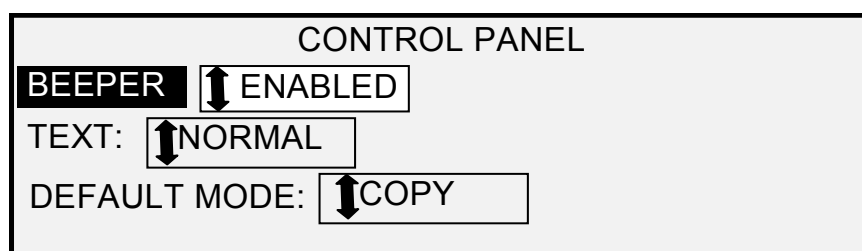

Control Panel Screen

5. Press the **Previous** or **Next** key to highlight BEEPER, TEXT MODE or DEFAULT MODE.
6. Press the **Enter** key to select the highlighted option.
7. Press the **Previous** or **Next** key to highlight the desired setting for the option.

The choices for BEEPER are ENABLED or DISABLED. ENABLED is the default setting. The Initialization Beep and the Fault Beep are not affected by this setting and cannot be turned off.

The choices for TEXT are NORMAL or BOLD. NORMAL is the default setting.

The choices for DEFAULT MODE are COPY or SCAN. COPY is the default setting.

NOTE: The DEFAULT MODE setting will not be displayed unless the Scan-to-Net feature is enabled. SCAN mode is an option on the 8825 and 8850 Scan Systems. To order this feature, contact XEROX Representative.

8. Press the **Enter** key to select the highlighted setting.
9. Repeat steps 5 through 8 if you wish to change another setting.
10. Press the **Exit** key to return to the CONFIGURATION menu screen.

COPY OPTIONS

The COPY OPTIONS feature of the CONFIGURATION menu provides a sub-menu of the following choices:

- MEDIA SERIES – Sets the standard media sizes for preset output formats. Table 5 shows the standard media series and the sizes associated with them.
- CUSTOM MEDIA FORMATS – Sets the custom media sizes for preset output formats.
- CUSTOM R/E PRESETS – Sets the reduction/enlargement ratios
- IMAGING – Sets the imaging options.

To access the COPY OPTIONS menu:

1. Press the **Menu** key. The MAIN MENU screen is displayed.
2. Press the **Enter** key to select CONFIGURATION. The CONFIGURATION menu screen is displayed.
3. Press the **Next** key until COPY OPTIONS is displayed. The COPY OPTIONS menu screen is displayed. The black arrows indicate that the menu contains more options than are visible. The selected option is highlighted.

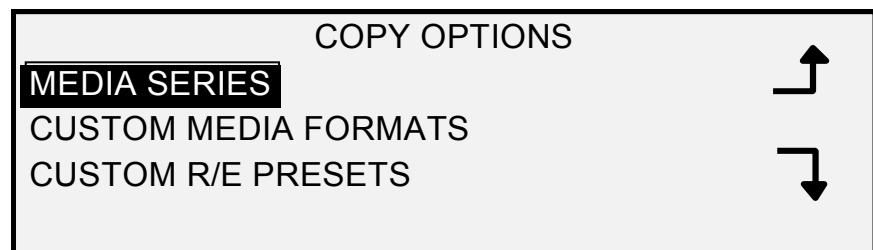

Copy Options Screen

4. Press the **Previous** or **Next** key to scroll through the list of options.
5. Press the **Enter** key to select the highlighted option. The screen for the selected option is displayed.

Table 5. Media sizes

Choose Series	To Display Sizes	Dimensions (width x length)
ANSI	A	8.5 x 11 inches (215.9 x 279.4 mm)
	B	11 x 17 inches (279.4 x 431.8 mm)
	C	17 x 22 inches (431.8 x 558.8 mm)
	D	22 x 34 inches (558.8 x 863.6 mm)
	E	34 x 44 inches (836.6 x 1117.6 mm)
ARCH	A	9 x 12 inches (228.6 x 304.8 mm)
	B	12 x 18 inches (304.8 x 457.2 mm)
	C	18 x 24 inches (457.2 x 609.6 mm)
	D	24 x 36 inches (609.6 x 914.4 mm)
	E	36 x 48 inches (914.4 x 1219.2 mm)
	30	30 x 42 Inches (76.2 x 106.7 mm)
ISO A	A4	210 x 297 mm
	A3	297 x 420 mm
	A2	420 x 594 mm
	A1	594 x 841 mm
	A0	841 x 1189 mm
ISO B	B4	250 x 353 mm
	B3	353 x 500 mm
	B2	500 x 707 mm
	B1	707 x 1000 mm
JIS B	B4	257 x 364 mm
	B3	364 x 515 mm
	B2	515 x 728 mm
	B1	728 x 1030 mm

MEDIA SERIES

The MEDIA SERIES option controls which standard media series are displayed when Preset is selected from the Output Format portion of the Scan System Control Panel.

You can select one or more media series to be displayed. Refer to Table 5 for a listing of the sizes associated with each media series.

To enable/disable a media series:

1. Press the **Menu** key. The MAIN MENU screen is displayed.
2. Press the **Enter** key to select CONFIGURATION. The CONFIGURATION menu screen is displayed.

3. Press the **Next** key until COPY OPTIONS is highlighted.
4. Press the **Enter** key to select COPY OPTIONS. The COPY OPTIONS menu screen is displayed.
5. Press the **Enter** key to select MEDIA SERIES. The MEDIA SERIES screen is displayed. Below is an example of the MEDIA SERIES screen.

MEDIA SERIES	
<input checked="" type="checkbox"/> ANSI	<input type="checkbox"/> ISO A
<input type="checkbox"/> ARCH	<input type="checkbox"/> ISO B
	<input type="checkbox"/> JIS B

Media Series Screen

6. Press the **Previous** or **Next** key to highlight a media series.
7. Press the **Enter** key to ENABLE or DISABLE the highlighted media series. A checkmark appears in the box to the left of the series when the series is enabled.

The factory default setting is ENABLED for the ANSI media series and DISABLED for all others.

8. Repeat steps 6 and 7 for each media series you wish to enable or disable.
9. Press the **Exit** key to return to the COPY OPTIONS menu screen.

CUSTOM MEDIA FORMATS

The CUSTOM MEDIA FORMATS option controls which custom media formats are displayed when Preset is selected from the Output Format portion of the Scan System Control Panel. You can specify up to six custom media formats. To use the SCANNER CONTROL, MODE: PRODUCTIVITY: CUSTOM mode, the custom sizes must be entered in the CUSTOM MEDIA FORMATS.

To specify a custom media format:

1. Press the **Menu** key. The MAIN MENU screen is displayed.
2. Press the **Enter** key to select CONFIGURATION. The CONFIGURATION menu screen is displayed.
3. Press the **Next** key until COPY OPTIONS is highlighted.
4. Press the **Enter** key to select COPY OPTIONS. The COPY OPTIONS menu screen is displayed.
5. Press the **Next** key to highlight CUSTOM MEDIA FORMATS.
6. Press the **Enter** key to select CUSTOM MEDIA FORMATS. The CUSTOM MEDIA FORMATS screen is displayed.

The first "0.0" in each "0.0 x 0.0" format represents the width. The second "0.0" represents the length.

NOTE: The formats are expressed in the units of measurement selected for the machine. Refer to "Localization" in the "Main Menu" section for further information.

Below is an example of the MEDIA SERIES screen. In the example, the display units have been set to inches.

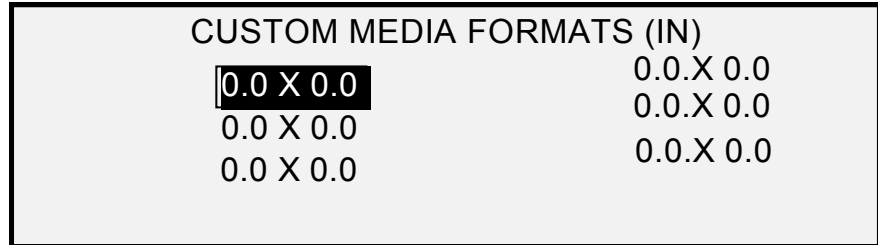

Custom Media Formats Screen

7. Press the **Previous** or **Next** key to highlight the desired field.
8. Use the numeric keypad to enter the value for the highlighted field.
9. Widths in excess of 36 inches (914 mm) or less than 11 inches (297 mm) are not valid.
10. Press the **Enter** key to confirm the value.
11. Repeat steps 7 through 9 until all desired formats are defined.

NOTE: Any custom formats that are not defined are automatically set to zero and are not displayed elsewhere.

12. Press the **Exit** key to return to the COPY OPTIONS menu screen.

CUSTOM R/E PRESETS

The CUSTOM R/E PRESETS option controls which reduction/enlargement ratios are displayed when Preset is selected from the Reduction/Enlargement portion of the Scan System Control Panel. You can specify up to six reduction/enlargement presets.

To specify a reduction/enlargement preset:

1. Press the **Menu** key. The MAIN MENU screen is displayed.
2. Press the **Enter** key to select CONFIGURATION. The CONFIGURATION menu screen is displayed.
3. Press the **Next** key until COPY OPTIONS is highlighted.
4. Press the **Enter** key to select COPY OPTIONS. The COPY OPTIONS menu screen is displayed.
5. Press the **Next** key until CUSTOM R/E PRESETS is highlighted.
6. Press the **Enter** key to select CUSTOM R/E PRESETS. The CUSTOM R/E PRESETS screen is displayed. Below is an example of the CUSTOM R/E PRESETS screen.

CUSTOM R/E PRESETS	
100.0%	100.0%
100.0%	100.0%
100.0%	100.0%

Custom R/E Presets Screen

7. Press the **Previous** or **Next** key to highlight the value that you wish to change.
8. Use the numeric keypad to enter the desired value. The valid value range is from 25% to 400%.

NOTE: Duplicate values are not displayed in the Preset Reduction/Enlargement list. You can remove a preset value from the list by setting the value to 100.0%.

9. Press the **Enter** key to confirm the value.
10. Repeat steps 7 through 9 for each value you wish to change.
11. Press the **Exit** key to return to the COPY OPTIONS menu screen.

IMAGING

The IMAGING option allows you to perform the following functions:

- **AUTO ROTATE** - Enable or disable automatic image rotation. If AUTO ROTATE is enabled, the scanned image will be electronically rotated 90 degrees only to match one of the page dimensions, prevent clipping on the selected roll, or to correct the orientation for use with the folder.
- **REDUCTION LINE PRESERVATION** - Use this feature to enable/disable line preservation when reducing normal and line-mode documents.

MAXIMUM COPY LENGTH – To see what your Scan System’s maximum copy length is, select the **Menu key > Configuration > Copy Options > Imaging > Maximum Copy Length**. The default is 100 feet. For the 6030/6050, the scanned copy would get cut off at 3 meters.

WARNING: Copy documents that are larger than the printer’s maximum capability will not print correctly, or may not print at all.

To enable/disable the imaging options:

1. Press the **Menu** key. The MAIN MENU screen is displayed.
2. Press the **Enter** key to select CONFIGURATION. The CONFIGURATION menu screen is displayed.

3. Press the **Next** key until COPY OPTIONS is highlighted.
4. Press the **Enter** key to select COPY OPTIONS. The COPY OPTIONS menu screen is displayed.
5. Press the **Next** key until IMAGING is highlighted.
6. Press the **Enter** key to select IMAGING. The IMAGING screen is displayed. Below is an example of the IMAGING screen.

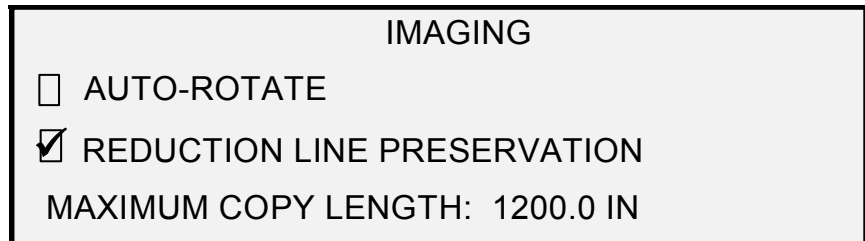

Imaging Screen

7. Press the **Previous** or **Next** key to highlight the desired option.
8. Press the **Enter** key to enable or disable the highlighted option. A checkmark appears in the box to the left of the option when the option is enabled.

The factory default setting is disabled for AUTO-ROTATE.

9. Repeat steps 7 and 8 to enable or disable REDUCTION LINE PRESERVATION, if desired.
10. Press the **Exit** key to return to the COPY OPTIONS menu screen.

IMAGE ENHANCEMENTS

The IMAGE ENHANCEMENT feature settings are used to enhance the appearance of color scanned images, particularly halftone color originals (for example, maps).

This feature will greatly enhance the printing of a color sample using the Color Scan-to-Print feature key.

To enable the IMAGE ENHANCEMENT features, perform the following:

1. Select the **Menu** key.
2. Press the **Enter** key to select CONFIGURATION. The CONFIGURATION menu screen is displayed.
3. Press the **Next** key until IMAGE ENHANCEMENT is highlighted.
4. Press the **Enter** key to select IMAGE ENHANCEMENT. The IMAGE ENHANCEMENT menu screen is displayed.
5. Press the **Next** key to highlight COLOR IQ.
6. Press the **Enter** key to select COLOR IQ. The COLOR IQ screen is displayed.

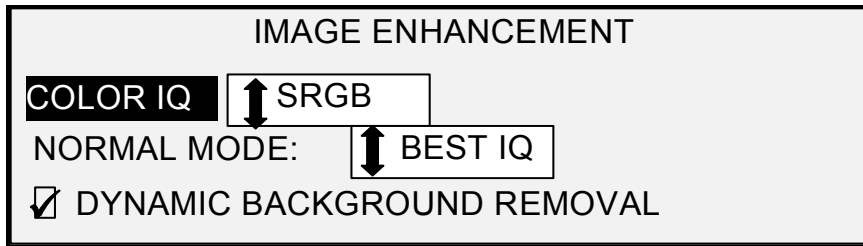

Image Enhancement Screen

7. Press the **Next** key to select the enhancement option you want:
 - NONE: scanned color has no color correction applied.
 - SRGB: scanned colors will be converted to the SRGB (Standard Red Green Blue) color space
 - ADAPTIVE CONTRAST: scanned colors are first converted to the SRGB color space, and then enhanced using an adaptive contrast algorithm. The adjustment changes the images white point, black point,

NOTE: Further color halftone image enhancement can be achieved when printing by enabling the Error Diffusion Raster Halftone Method in the controller Web Print Management Tool. The setting is found on the Processing Defaults page. Select Error Diffusion from the Raster Halftone Method pull-down menu.

8. Press the **Enter** key to select the enhancement setting.
9. Press the **Next** key to select NORMAL MODE then press the **Enter** key to select Normal Mode.
10. Press **Previous** or **Next** to scroll through the settings BEST IQ and FASTEST, then press the **Enter** key to select the setting. BEST IQ is the default.
11. Press the **Next** key to select DYNAMIC BACKGROUND SUPPRESSION. Then press the **Enter** key to enable/disable DYNAMIC BACKGROUND REMOVAL. Disabling the DYNAMIC BACKGROUND REMOVAL enables the STATIC BACKGROUND REMOVAL. DYNAMIC BACKGROUND REMOVAL is the default and should be used for most document types.
12. Press the **Enter** key to confirm the selection.
13. Press the **Exit** key to return to the CONFIGURATION menu.

TIMERS

The TIMERS option of the CONFIGURATION menu allows you to set the values for the time-out functions. Pressing any key or scanning a document resets the timers.

The timers are as follows:

- FEATURE – Controls how long the current feature parameters remain in effect after the last key press, scan completion, or insertion of a document into the Scan System. The FEATURE timer can be set between 0 and 99 minutes. The factory default

is 5 minutes. A value of 0 means that the feature will never time out.

NOTE: To prevent images from being lost, feature time-outs will not occur during the sets build process.

- **PRINTER INTERRUPT** - Controls how long the Printer remains in the interrupted state with no interruption at the Scan System Control Panel. This timer pertains to print jobs that have been interrupted to allow a copy job to process. The allowed range is 1 to 99 minutes. The factory default is 1 minute.
- **FILE DELETION** - Specifies the maximum amount of time a scanned image file remains on the file system before being deleted. This timer pertains only to files scanned when the WIDE FORMAT COPY SYSTEM is in the READY TO SCAN mode. This timer can be set between 1 and 24 hours in increments of 1 hour. When a file is scanned in, it is given a time stamp. When the age of the file on the hard disk exceeds the value of the FILE DELETION timer, the file is automatically deleted to allow space for new files. The default value is 24 hours. After the files have been deleted, the directory will also be deleted if no other files are scanned to it.

To adjust a timer:

1. Press the **Menu** key. The MAIN MENU screen is displayed.
2. Press the **Enter** key to select CONFIGURATION. The CONFIGURATION menu screen is displayed.
3. Press the **Next** key until TIMERS is highlighted.
4. Press the **Enter** key to select TIMERS. The TIMERS screen is displayed.

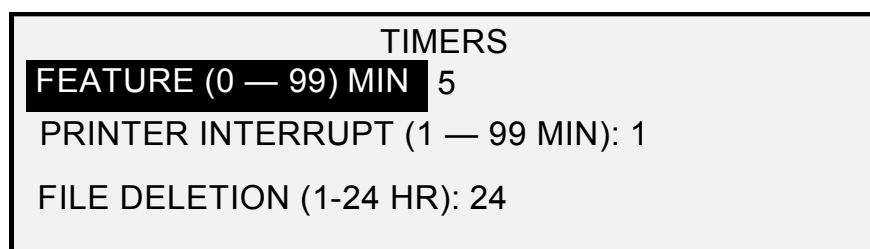

Timers Screen

5. Press the **Previous** or **Next** key to highlight the desired timer.
6. Press the **Enter** key to select the highlighted timer.
7. Use the numeric keypad to enter the timer value.
8. Press the **Enter** key to confirm the value.
9. Repeat steps 5 through 8 if you want to set the value for additional timers.
10. Press the **Exit** key to return to the CONFIGURATION menu screen.

POWER SAVER

The POWER SAVER option of the CONFIGURATION menu allows you to set the number of hours of inactivity after which the system goes into Power Saver mode.

To adjust the power saver:

1. Press the **Menu** key. The MAIN MENU screen is displayed.
2. Press the **Enter** key to select CONFIGURATION. The CONFIGURATION menu screen is displayed.
3. Press the **Next** key until POWER SAVER is highlighted.
4. Press the **Enter** key to select POWER SAVER. The POWER SAVER screen is displayed.



POWER SAVER
POWER SAVER DELAY (0 – 4 HR):

Power Saver Screen

5. Use the numeric keypad to enter the power saver value. The valid value range is 0 to 4 hours. The factory default is 3 hours.
6. Press the **Enter** key to confirm the value.
7. Press the **Exit** key to return to the CONFIGURATION menu screen.

SCANNER CONTROL

The SCANNER CONTROL option of the CONFIGURATION menu allows you to set the options for how the Scan System starts and finishes a scan. It contains the following features:

- AUTOSCAN - Tells the Scan System either to start the scan automatically when the document is inserted (ENABLED), or to wait until the **Start** key is pressed (DISABLED). ENABLED is the factory default setting.
- DOCUMENT RETURN - Tells the Scan System, after the scan, either to return the document to the front of the Scan System (FRONT), or to drop the document from the rear of the Scan System into the catch tray (REAR). REAR is the factory default setting.

NOTE: Refer to *Controlling the Scan* for additional information.

MODE: (PRODUCTIVITY is the default.)

- MANUAL WIDTH - The user must enter the document width and very carefully center the document. In this mode the document will be prescanned.
- AUTOWIDTH - Enables the automatic detection of the width of the document. In this mode the document will be prescanned.

- AUTOWIDTH/AUTOCENTER - Enables the automatic centering of the image and automatic width detection. This selection is the default. In this mode the document will be prescanned.
- PRODUCTIVITY - This feature does not use AUTOCENTER, requiring the operator to manually align the document within the media guidelines on the Feed-in Tray. The width sensors eliminate the need for a prescan, thereby increasing the overall throughput of the system resulting in higher productivity. When this feature is used, the operator must select the media series, ANSI, ARCH, ISO A, ISO B, JIS B and CUSTOM etc. since the number of sensors provided cannot monitor every media type. To use the MODE: PRODUCTIVITY: CUSTOM the custom sizes must be entered in the CUSTOM MEDIA FORMATS (Select the **Menu key** > CONFIGURATION>COPY OPTIONS).

To set the Scanner Control features:

1. Press the **Menu** key. The MAIN MENU screen is displayed.
2. Press the **Enter** key to select CONFIGURATION. The CONFIGURATION menu screen is displayed.
3. Press the **Next** key until SCANNER CONTROL is highlighted.
4. Press the **Enter** key to select SCANNER CONTROL. The SCANNER CONTROL screen is displayed.

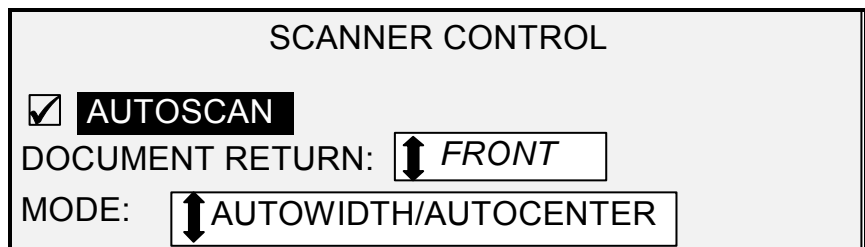

ScannerControl Screen

5. Press the **Previous** or **Next** key to select the desired feature.
6. Press the **Enter** key to confirm the choice.
7. Press the **Previous** or **Next** key to select the desired setting.
 - For AUTOSCAN, you can enable or disable the feature. A checkmark in the box to the left of the feature indicates that the feature is enabled. Enabled is the factory default setting for these features.
 - For DOCUMENT RETURN, the selections are FRONT and REAR. FRONT is the factory default setting.
 - For MODE: use the **Previous** or **Next** keys to select the desired option then press the **Enter** key to confirm the choice. The options are MANUAL, AUTOWIDTH, AUTOWIDTH/AUTOCENTER, or PRODUCTIVITY. If PRODUCTIVITY is selected, then use the **Previous** or **Next** key to select the ANSI, ARCH, ISO A, ISO B, JISB, or CUSTOM setting.

- Use the **CUSTOM** setting when documents of mixed series will be scanned in the same job. The **CUSTOM** selection uses the custom sizes that are entered in the **CUSTOM MEDIA SIZES** (Menu key > **CONFIGURATION**>**COPY OPTIONS**).

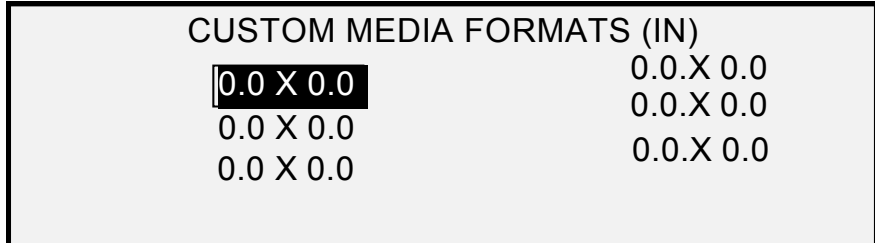

Custom Media Formats Screen

8. Press the **Exit** key to return to the **CONFIGURATION** menu screen.

System Information menu

The **SYSTEM INFORMATION** option of the **MAIN MENU** contains the following menu choices:

- **SYSTEM DESCRIPTION** - Provides information about each component connected to the **WIDE FORMAT COPY SYSTEM**.
- **RECENT FAULT LIST** - Displays the most recent faults related to the **Scan System**.
- **CONFIGURATION PRINTS** - Prints Copier and Printer configuration pages.

To access the **SYSTEM INFORMATION** menu:

1. Press the **Menu** key. The **MAIN MENU** screen is displayed.
2. Press the **Next** key to highlight **SYSTEM INFORMATION**.
3. Press the **Enter** key to select **SYSTEM INFORMATION**. The **SYSTEM INFORMATION** menu screen is displayed. The black arrows indicate that the menu contains more options than are visible. The selected option is highlighted.

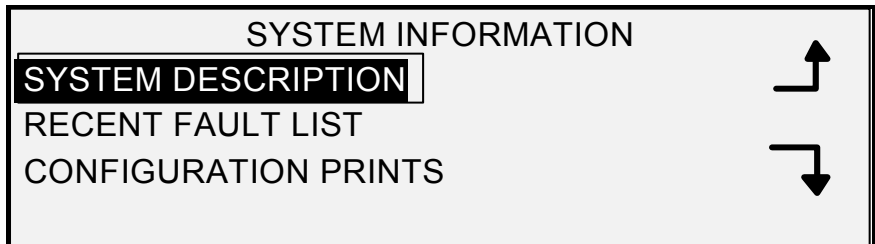

System Information Screen

4. Press the **Previous** or **Next** key to scroll through the list of options.
5. When the desired option is highlighted, press the **Enter** key to select the option. The menu or screen for the selected option is displayed.

SYSTEM DESCRIPTION

The SYSTEM DESCRIPTION option of the SYSTEM INFORMATION menu provides information on the model identity and firmware version for each component connected to the WIDE FORMAT COPY SYSTEM.

To display component information:

1. Press the **Menu** key. The MAIN MENU screen is displayed.
2. Press the **Next** key to highlight the SYSTEM INFORMATION option.
3. Press the **Enter** key to select SYSTEM INFORMATION. The SYSTEM INFORMATION menu screen is displayed.
4. Press the **Enter** key to select SYSTEM DESCRIPTION. The SYSTEM DESCRIPTION screen is displayed.

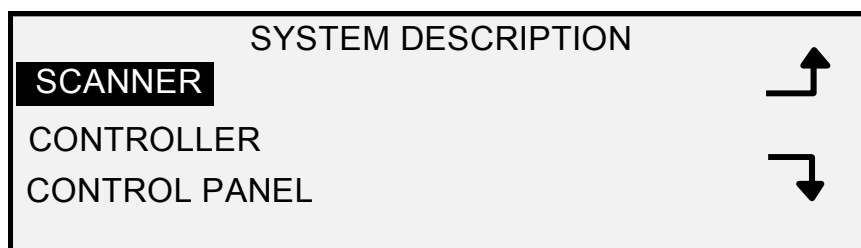

System Description Screen

5. Press the **Previous** or **Next** key to highlight the component about which you want to view information.
6. Press the **Enter** key to select the highlighted component. The screen for the selected component is displayed. Following are examples of the screens for each of the components.

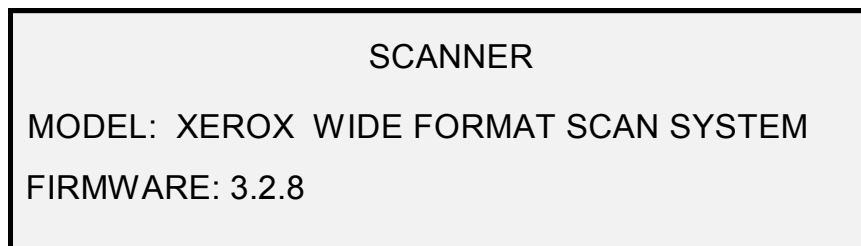

Scanner Screen



Controller Screen

NOTE: The *CONTROLLER* screen also provides the amount of Random Access Memory (RAM).

CONTROL PANEL
MODEL: 1
FIRMWARE: 1.1.0

Control Panel Screen

PRINTER
MODEL: XEROX XXXX WIDE FORMAT
FIRMWARE: XXX

Printer Screen

NOTE: The XXXX represents the Printer name.

FINISHER
MODEL:
NONE

Finisher Screen

NOTE: This screen identifies the Finisher, if any. If there is no finisher, the MODEL is displayed as NONE. If a Folder is connected, the FINISHER screen displays the configuration of the connected Folder.

7. Press the **Exit** key to return to the SYSTEM DESCRIPTION screen.

RECENT FAULT LIST

The RECENT FAULT LIST option of the SYSTEM INFORMATION menu displays the most recent faults related to the Scan System. Fault messages are stored in the Controller. Each fault message contains a fault code and a digital time stamp. When you call for service, the service center may ask you for this information.

To display the recent fault list:

1. Press the **Menu** key. The MAIN MENU screen is displayed.
2. Press the **Next** key to highlight SYSTEM INFORMATION.
3. Press the **Enter** key to select SYSTEM INFORMATION. The SYSTEM INFORMATION menu screen is displayed.

4. Press the **Next** key to highlight RECENT FAULT LIST. Press the **Enter** key to select RECENT FAULT LIST. The RECENT FAULT LIST screen is displayed. Below is an example of the RECENT FAULT LIST screen. The first column is the time given in seconds since January 1, 1970. That's what is used to determine the actual system date and time.
5. Go to the Problem Solving section of this document to look up the second column's fault code.

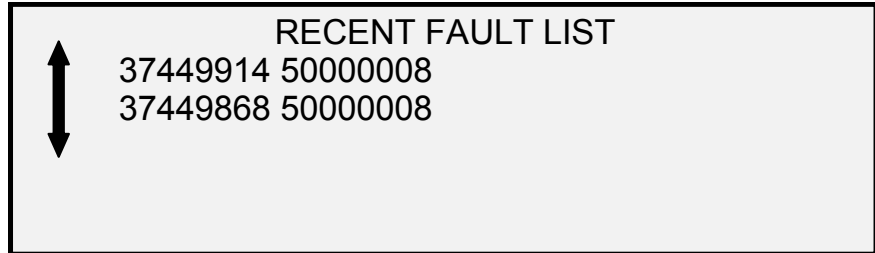

Recent Fault List Screen

6. Press the **Previous** or **Next** key to scroll through the list.
7. Press the **Exit** key to return to the SYSTEM INFORMATION menu screen.

CONFIGURATION PRINTS

The CONFIGURATION PRINTS option of the SYSTEM INFORMATION menu allows you to print one of the following selections:

- Copier Configuration
- Printer Configuration
- Printer Settings
- All of the above.

To print a configuration print:

1. Press the **Menu** key. The MAIN MENU screen is displayed.
2. Press the **Next** key to highlight SYSTEM INFORMATION.
3. Press the **Enter** key to select SYSTEM INFORMATION. The SYSTEM INFORMATION menu screen is displayed.
4. Press the **Previous** or **Next** key until CONFIGURATION PRINTS is highlighted.
5. Press the **Enter** key to select CONFIGURATION PRINTS. The CONFIGURATION PRINTS screen is displayed.

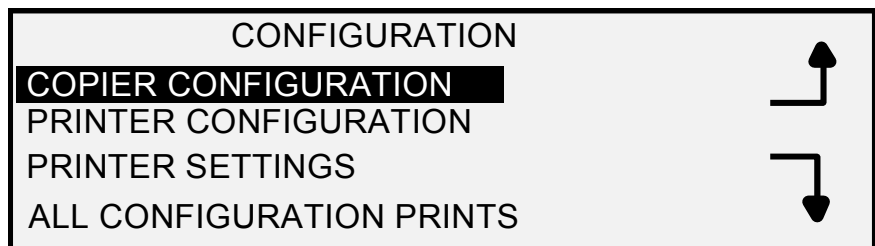

Configuration Screen

6. Press the **Previous** or **Next** key to highlight the configuration page you want to print.
7. Press the **Enter** key to select the highlighted configuration. The screen for the selected configuration is displayed. The default response is YES.

Below is an illustration of the COPIER CONFIGURATION screen.

COPIER CONFIGURATION

QUEUE TO PRINTER:

Copier Configuration Screen

8. Press the **Enter** key to confirm the response. A status message is displayed indicating that the configuration has been queued to the Printer.

Below are illustrations of the other CONFIGURATION PRINT screens with the status message.

PRINTER CONFIGURATION

QUEUE TO PRINTER:

Printer Configuration Screen

PRINTER SETTINGS

QUEUE TO PRINTER:

Printer Settings Screen

ALL CONFIGURATION PRINTS

QUEUE TO PRINTER:

All Configuration Prints Screen

9. Press the **Exit** key to return to the CONFIGURATION PRINTS screen.

System Administration menu

The SYSTEM ADMINISTRATION option of the MAIN MENU is reserved for the system administrator. It can be accessed only after entering the system administration password.

When this option is selected, the system administrator is immediately prompted for a password. See "Entering the system administration password" in this section for complete information about the password entry.

Once the system administration password has been entered correctly, the SYSTEM ADMINISTRATION menu screen is displayed. It contains the following options:

- **JOB ACCOUNTING MODE** - Allows the system administrator to enable the Job Accounting Mode. The options are DISABLED, ENABLED, and OPTIONAL. The default is DISABLED.
- **FILE SYSTEM** - Allows the system administrator to view and delete account information.
- **CHANGE PASSWORD** - Allows the system administrator to change the system administration password.

SECURITY SETTINGS - Allows the system administrator to set the image recall feature. The immediate overwriting of data to DOD specification is such that the system, at any point in its operation, can be considered secure and all data will be removed no matter what operation the customer is performing.

Entering the system administration password

Access to the SYSTEM ADMINISTRATION menu requires the entry of the system administration password.

To enter the system administration password:

1. Press the **Menu** key. The MAIN MENU screen is displayed.
2. Press the **Previous** or **Next** key until SYSTEM ADMINISTRATION is highlighted.
3. Press the **Enter** key to select SYSTEM ADMINISTRATION. The SYSTEM ADMINISTRATION password screen is displayed.

SYSTEM ADMINISTRATION

ENTER PASSWORD:

System Administration Screen

4. Use the numeric keypad to enter the password. The password will display as asterisks.
5. Press the **Enter** key to confirm the password entry. The SYSTEM ADMINISTRATION menu screen is displayed. The black arrows indicate that the menu contains more options than are visible. The selected option is highlighted.

SYSTEM
<div style="background-color: black; color: white; padding: 2px;">JOB ACCOUNTING MODE</div> FILE SYSTEM CHANGE PASSWORD SECURITY SETTINGS

System Screen

NOTE: If an incorrect password is entered, an error message will be displayed as shown below. Enter the password again.

SYSTEM ADMINISTRATION
PASSWORD: <input style="width: 50px;" type="password" value="*****"/>
INVALID PASSWORD, RE-ENTER

System Administration Screen

6. Press the **Previous** or **Next** key to scroll through the list of system administration options.
7. Press the **Enter** key to select the desired option.

JOB ACCOUNTING

The JOB ACCOUNTING option of the System Administration menu allows the system administrator with access to enable Job Accounting. The options are DISABLED, ENABLED, and OPTIONAL. The default is DISABLED.

FILE SYSTEM

The FILE SYSTEM option of the SYSTEM ADMINISTRATION menu provides a sub-menu of the following menu choices:

- LIST BY DIRECTORY- Allows the system administrator to list the number of images stored under each directory and the percentage of total hard disk space consumed by the directory.
- DELETE IMAGES - Allows the system administrator to delete all of the images scanned for a particular directory.
- DELETE ALL IMAGES - Allows the system administrator to delete all of the images currently stored on the hard disk.

To access the FILE SYSTEM menu:

1. Access the SYSTEM ADMINISTRATION menu. See "Entering the system administration password" in this section.

2. Press the **Next** key to highlight FILE SYSTEM.
3. Press the **Enter** key to select FILE SYSTEM. The FILE SYSTEM menu screen is displayed.

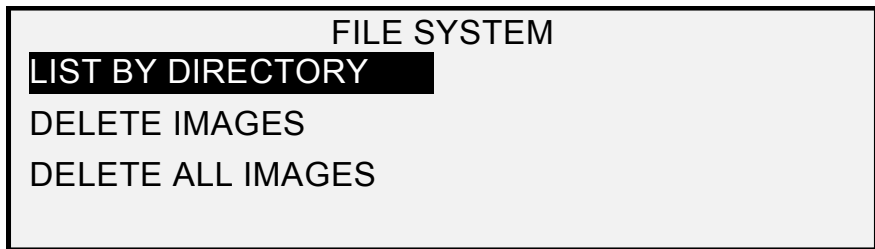

File System Screen

4. Press the **Previous** or **Next** key to highlight the desired option.
5. Press the **Enter** key to select the highlighted option.

**LISTING STORED
IMAGE INFORMATION
BY DIRECTORY**

The LIST BY DIRECTORY option allows the system administrator to display a list of the number of images stored under each directory and the percentage of total hard disk space consumed by each account.

To list scanned image information by account:

1. Access the SYSTEM ADMINISTRATION menu. See "Entering the system administration password" in this section.
2. Press the **Next** key to highlight FILE SYSTEM.
3. Press the **Enter** key to select FILE SYSTEM. The FILE SYSTEM menu screen is displayed.
4. Press the **Enter** key to select LIST BY DIRECTORY. The LIST BY DIRECTORY screen is displayed. The following illustration is a DIRECTORY example of the LIST BY screen.

NOTE: Directories that do not contain files will not be displayed. Directories not containing files are deleted.

LIST BY DIRECTORY		
DIRECTORY	COUNT	SIZE (%)
images	2*	<1
images	35	2

List by Directory Screen

For each directory, the account name (DIRECTORY), the number of images stored under the directory (COUNT), and the percentage of total disk space consumed by the account (SIZE (%)) are shown. The length of the directory name may cause the information associated with the directory to wrap to the next line. Also, if the directory name exceeds the character limit of the first line, the name will be truncated at the width of the screen.

Use the **Previous** or **Next** key to scroll through the list.

An asterisk in the COUNT field indicates that some images in memory have not yet been processed. A "<1" in the SIZE field indicates the account uses less than 1% of the total disk space on the file system.

5. Press the **Exit** key to return to the FILE SYSTEM menu screen.

DELETING STORED IMAGES BY DIRECTORY

The DELETE IMAGE option allows the system administrator to delete all the images stored for a particular account.

To delete stored images by account:

1. Access the SYSTEM ADMINISTRATION menu. See "Entering the system administration password" in this section.
2. Press the **Next** key to highlight FILE SYSTEM.
3. Press the **Enter** key to select FILE SYSTEM. The FILE SYSTEM menu screen is displayed.
4. Press the **Next** key to highlight DELETE IMAGES.
5. Press the **Enter** key to select DELETE IMAGES. The DELETE IMAGES screen is displayed.

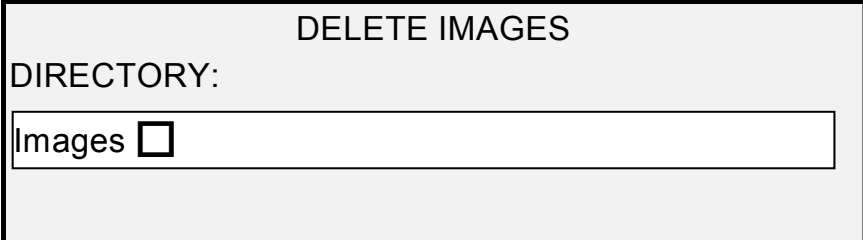

DELETE IMAGES

DIRECTORY:

Images

Delete Images Screen

6. Use the numeric keypad to enter the name of the directory from which you would like delete the stored images.
7. Press the **Enter** key to confirm the account number. A delete confirmation screen is displayed. The default response is NO.

The following illustration is an example of the DELETE IMAGES screen.

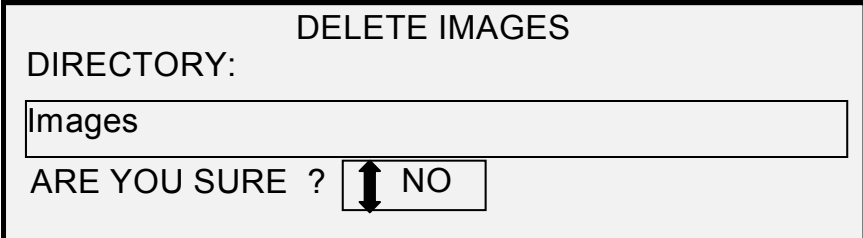

DELETE IMAGES

DIRECTORY:

Images

ARE YOU SURE ? NO

Delete Images- Are You Sure Screen

8. Press the **Previous** or **Next** key to change the response to YES.
9. Press the Enter key to confirm the deletion. While the deletion is in process, a "DELETING. . ." message is displayed. When the deletion is complete, the status changes to IMAGES DELETED. Below is an example of the deletion screen.

**DELETING ALL
STORED IMAGES**

DELETE IMAGES

DIRECTORY:

Images

IMAGES DELETED

Delete Images – Images Deleted Screen

10. Press the **Exit** key to return to the FILE SYSTEM menu screen.

The DELETE ALL IMAGES option allows the system administrator to delete all the images stored on the file system.

To delete all stored images:

1. Access the SYSTEM ADMINISTRATION menu. See "Entering the system administration password" in this section.
2. Press the **Next** key to highlight FILE SYSTEM.
3. Press the **Enter** key to select FILE SYSTEM. The FILE SYSTEM menu screen is displayed.
4. Press the **Next** key until DELETE ALL IMAGES is highlighted.
5. Press the **Enter** key to select DELETE ALL IMAGES. The DELETE ALL IMAGES screen is displayed. The default response is NO.

DELETE ALL IMAGES

ARE YOU SURE?:

Delete All Images Screen

6. Press the **Previous** or **Next** key to change the response to YES.
7. Press the **Enter** key to confirm the deletion. While the deletion is in process, a "DELETING. . ." message is displayed. When the deletion is complete, the status changes to IMAGES DELETED.

DELETE IMAGES

ARE YOU SURE?:

IMAGES DELETED

Delete Images – Are You Sure Screen

8. Press the **Exit** key to return to the FILE SYSTEM menu screen.

CHANGE PASSWORD

The CHANGE PASSWORD option of the SYSTEM ADMINISTRATION menu allows the system administrator to change the system administration password.

The default system administration password on all newly delivered machines is 0 (zero). The system administrator is required to change the password after the initial log in. Immediately following the log in, the CHANGE PASSWORD screen is displayed. The password must be changed at that time.

If the existing password has been lost, call for service. The customer service engineer will reset the password to the default value of 0. The system administrator should then change the password to a different value.

NOTE: Changing the system administrator password on the Scan System Control Panel also changes the system administrator password for the Printer. These two passwords always have the same value.

To change the system administration password:

1. Select the **Menu** key.
2. Access the **SYSTEM ADMINISTRATION** menu. See "Entering the system administration password" in this section.
3. Press the **Next** key until CHANGE PASSWORD is highlighted.
4. Press the **Enter** key to select CHANGE PASSWORD. The CHANGE PASSWORD screen is displayed.

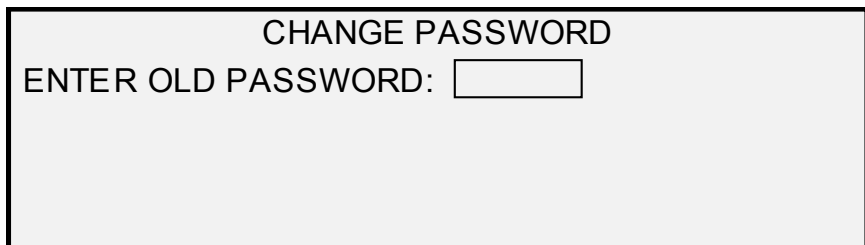

CHANGE PASSWORD
ENTER OLD PASSWORD:

Change Password Screen

5. Use the numeric keypad to enter the old password.
6. Press the **Enter** key to confirm the old password. The CHANGE PASSWORD screen will instruct you to enter the new password.

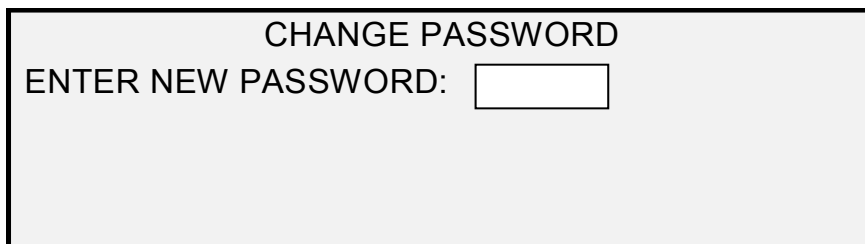

CHANGE PASSWORD
ENTER NEW PASSWORD:

Change Password Screen

7. Use the numeric keypad to enter the new password. The password will display as asterisks.

NOTE: The valid range for passwords is 0 - 65535. If the existing password or an invalid password is entered, an error message will be displayed. The new password must be entered again.

8. Press the **Enter** key to confirm the new password. The CHANGE PASSWORD screen will instruct you to re-enter the new password.

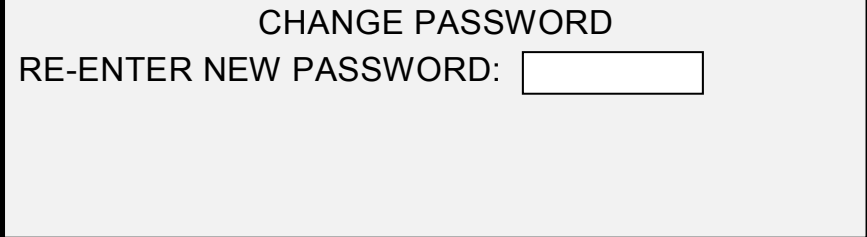

CHANGE PASSWORD
RE-ENTER NEW PASSWORD:

Change Password – Re-Enter Password Screen

9. Use the numeric keypad to re-enter the new password. The password will display as asterisks.
10. Press the **Enter** key to confirm the re-entry. You will be returned to the SYSTEM ADMINISTRATION menu screen. The new password is now effective. The old password is no longer valid.

SECURITY SETTINGS

Scan-to-FTP: Scanned images can be transferred to 4 remote FTP destinations. The scanned images are not stored on the Controller's hard drive. The FTP feature is located on the Sample Mode screen.

Scan-to-Net: At most installations, users have the ability to recall the last image scanned (that was not sent to an FTP destination) and all the settings associated with that image. The recalled image can then be printed without the need to scan from the original document.

Security concerns at certain installations, however, might require that the image recall feature be disabled. The SECURITY SETTINGS option of the System Administration menu allows the system administrator to enable or disable the image recall feature. The default setting is ENABLED.

To enable/disable the image recall feature:

1. Select the **Menu** key.
2. Access the **SYSTEM ADMINISTRATION** menu.
3. Press the **Next** key until SECURITY SETTINGS is highlighted.
4. Press the **Enter** key to select SECURITY SETTINGS. The SECURITY SETTINGS screen is displayed.

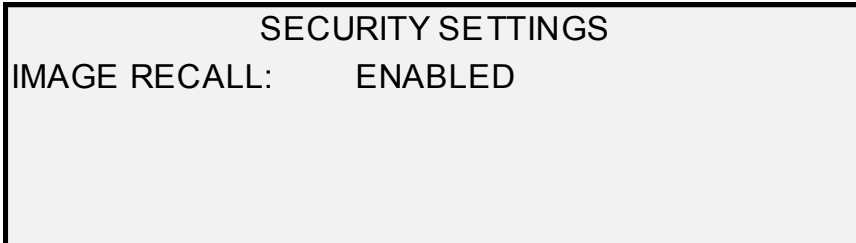

Security Settings Screen

5. Press the **Previous** or **Next** key to highlight the desired response, ENABLED or DISABLED.
6. Press the **Enter** key to confirm your selection.
7. Press the **Exit** key to return to the SYSTEM ADMINISTRATION menu screen.

Diagnostics menu

The DIAGNOSTICS option of the Main Menu contains the following menu choices:

NOTE: *Some of the scanner diagnostics listed below require a password to access and are performed only by a Customer Service Engineer.*

- USAGE METERS - Enables you to view usage information for documents scanned and media printed.
- CLEAR USAGE - Enables the Customer Service Engineer to reset to zero the usage value for documents scanned. The diagnostic password is required for this function.
- SCANNER DIAGNOSTICS - Provides a sub-menu of Scan System diagnostic routines. Some of these routines are accessible by both the operator and the Customer Service Engineer, but should only be accessed by an operator when directed to do so by Service. Access to these tests has been given to enable some preliminary diagnostics to be done by phone before a Customer Service Engineer is dispatched. Others are accessible by the Service Engineer only and require the entry of the diagnostic password.
- INSTALLATION TEST PRINT - Enables the Customer Service Engineer to make a copy of the test print to assist in diagnosing the Scan System.
- PASSWORD - Enables the Customer Service Engineer to enter the password for access to password-protected diagnostic functions.

To access the DIAGNOSTICS menu:

1. Press the **Menu** key. The MAIN MENU screen is displayed.

2. Press the **Next** key until DIAGNOSTICS is highlighted.
3. Press the **Enter** key to select DIAGNOSTICS. The DIAGNOSTICS menu screen is displayed. The black arrows indicate the menu contains more options than are visible. The selected option is highlighted.



Diagnostics Menu

4. Press the **Previous** or **Next** key to scroll through the list of options.
5. When the desired option is highlighted, press the **Enter** key to select the option. The menu or screen for the selected option is displayed.

USAGE METERS

Select the USAGE METERS option of the DIAGNOSTICS menu to view the total system usage for documents scanned and media printed.

To view area and media usage:

1. Press the **Menu** key. The MAIN MENU screen is displayed.
2. Press the **Next** key until DIAGNOSTICS is highlighted.
3. Press the **Enter** key to select DIAGNOSTICS. The DIAGNOSTICS menu screen is displayed.
4. Press the **Enter** key to select USAGE METERS. The USAGE METERS screen is displayed.

The USAGE METERS screen provides Scan System area usage and media usage. Scan System area usage is measured in square units. Media usage is measured in both linear and square units. Units are displayed as either feet or meters depending on the display units selected for the Scan System. Refer to "Localization" in the "Main Menu" section for complete information about setting the display units.

Below is an example of the USAGE METERS screen. In the example, the units are displayed as meters.

USAGE METERS	
SCANNER (F ²):	11
MEDIA LINEAR	307
MEDIA AREA	670

Usage Meters Screen

5. When finished viewing the usage information, press the **Exit** key to return to the DIAGNOSTICS menu screen.

CLEAR SCANNER USAGE

The CLEAR SCANNER USAGE option of the DIAGNOSTICS menu is for use by the Customer Service Engineer only. It requires the entry of the diagnostic password. It allows the Customer Service Engineer to reset to zero the usage value for documents scanned.

If you select this option, the CLEAR SCANNER USAGE screen is displayed. You cannot perform any functions in this screen. Press the Exit key to return to the DIAGNOSTICS menu screen.

Below is an example of the Clear Scanner Usage screen. In the example, the units are displayed as square feet.

CLEAR SCANNER USAGE	
SCANNER (F ²) :	1234
ARE YOU SURE?:	<input type="button" value="↕ NO"/>

Clear Scanner Usage Screen

SCANNER DIAGNOSTICS

The SCANNER DIAGNOSTICS option of the DIAGNOSTICS menu provides a sub-menu of the following choices:

- IMAGE PATH - Enables you to validate the operation of the image processing (IP) card and the image bar.
- SCAN BAR - Enables you to calibrate the response of the scan bar.
- FULL SYSTEM TEST - Enables you to run all applicable tests on the Scan System to determine if it is working properly.
- WRITE NVR - Enables the Customer Service Engineer to modify the contents of the non-volatile memory of the Scan System. The diagnostic password is required for this function.
- RESET NVR DEFAULTS - Enables the Customer Service Engineer to reset the NVR values to the factory default values. The diagnostic password is required for this function.
- SCANNER RELIABILITY METER - Enables you to gather data about the usage of the scanning mechanism.
- SCANNER FAULTS (ORDERED) - Enables you to view the entries in the internal Scanner Fault Log.
- FAULTS (COUNTS) - Enables you to view the last cleared faults.
- CLEAR SCANNER FAULT LOG - Enables the Customer Service Engineer to erase the contents of the Scanner Fault Log. The diagnostic password is required for this function.

- CLEAN CALIBRATION ZONE - Enables you to quickly move the calibration surface to the cleaning position.
- COMPONENT TESTS - Provides a sub-menu of Scanner component diagnostic routines. Some of these routines are accessible by both the operator and the Customer Service Engineer. Others are accessible by the Customer Service Engineer only and require the entry of the diagnostic password.
- READ NVR - Enables you to examine the contents of the non-volatile RAM (NVR).

To access the SCANNER DIAGNOSTICS menu:

1. Press the **Menu** key. The MAIN MENU screen is displayed.
2. Press the **Next** key until DIAGNOSTICS is highlighted.
3. Press the **Enter** key to select DIAGNOSTICS. The DIAGNOSTICS menu screen is displayed.
4. Press the **Next** key until SCANNER DIAGNOSTICS is highlighted.
5. Press the **Enter** key to highlight SCANNER DIAGNOSTICS. The SCANNER DIAGNOSTICS menu screen is displayed. The black arrows indicate that the menu contains more options than are visible. The selected option is highlighted.



Scanner Diagnostics Screen

6. Press the **Previous** or **Next** key to scroll through the list of options.
7. When the desired option is highlighted, press the **Enter** key to select the option. The menu or screen for the selected option is displayed.

IMAGE PATH

Select the IMAGE PATH option to validate the operation of the image processing (IP) card and the image bar.

To run the IMAGE PATH diagnostic:

1. Press the **Menu** key. The MAIN MENU screen is displayed.
2. Press the **Next** key until DIAGNOSTICS is highlighted.
3. Press the **Enter** key to select DIAGNOSTICS. The DIAGNOSTICS menu screen is displayed.
4. Press the **Next** key until SCANNER DIAGNOSTICS is displayed.
5. Press the **Enter** key to select SCANNER DIAGNOSTICS. The SCANNER DIAGNOSTICS menu screen is displayed.

6. Press the **Enter** key to select IMAGE PATH. The IMAGE PATH screen is displayed.

IMAGE PATH	
BOARD ID: 2	STATUS: 0
BAR1: 0	BAR2: 0
BAR3: 0	ALL: 0

Image Path Screen

When you enter the IMAGE PATH screen, the status field for all tests contains a "0." After a few seconds, the results of the tests are displayed. A test result with no failure displays as PASS. A test result with a failure displays a failure code. If a failure code is displayed, call for service.

7. Press the **Exit** key to return to the SCANNER DIAGNOSTICS menu screen.

SCAN BAR

Select the SCAN BAR option to calibrate the response of the scan bar.

To run the SCAN BAR diagnostic:

1. Press the **Menu** key. The MAIN MENU screen is displayed.
2. Press the **Next** key until DIAGNOSTICS is highlighted.
3. Press the **Enter** key to select DIAGNOSTICS. The DIAGNOSTICS menu screen is displayed.
4. Press the **Next** key until SCANNER DIAGNOSTICS is displayed.
5. Press the **Enter** key to select SCANNER DIAGNOSTICS. The SCANNER DIAGNOSTICS menu screen is displayed.
6. Press the **Next** key to highlight SCAN BAR.
7. Press the **Enter** key to select SCAN BAR. The SCAN BAR screen is displayed.

SCAN BAR CALIBRATION TEST
PRESS START TO BEGIN

Scan Bar Screen

8. Press the **Start** key to begin the test. While the test is executing, the bottom display line changes to "RUNNING."

At the completion of the test, the test result is displayed. A test result with no failure displays as PASSED. A test result with a failure displays as FAILED followed by ERROR CODE: and a hexadecimal value between 0 and FF. If a failure code is displayed, call for service.

9. Press the **Exit** key to return to the SCANNER DIAGNOSTICS menu screen.

FULL SYSTEM TEST

Select the FULL SYSTEM TEST option to run all applicable tests on the Scan System to determine if it is working properly.

To run the FULL SYSTEM TEST diagnostic:

1. Press the **Menu** key. The MAIN MENU screen is displayed.
2. Press the **Next** key until DIAGNOSTICS is highlighted.
3. Press the **Enter** key to select DIAGNOSTICS. The DIAGNOSTICS menu screen is displayed.
4. Press the **Next** key until SCANNER DIAGNOSTICS is displayed.
5. Press the **Enter** key to select SCANNER DIAGNOSTICS. The SCANNER DIAGNOSTICS menu screen is displayed.
6. Press the **Next** key until FULL SYSTEM TEST is highlighted.
7. Press the **Enter** key to select FULL SYSTEM TEST. The FULL SYSTEM TEST screen is displayed.

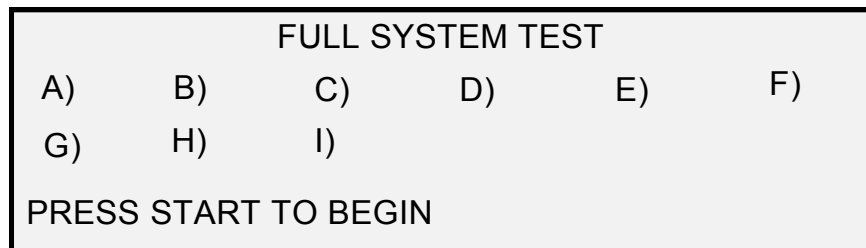

Full System Test Screen

Nine sub-tests are included in the system test. Each letter on the screen corresponds to a sub-test as follows:

- a) Post Test 5 – NVM (Non Volatile Memory) Verification
 - b) Post Test 6 – Motor Communications
 - c) Post Test 7 – SCVM Code Checksum
 - d) Post Test 8 – SCVM (Scan System Virtual Memory) Load and Functional Test
 - e) Post Test 9 – Pixel Magic Interface
 - f) Post Test A – Pixel Magic Internal
 - g) Post Test B – Video Path
 - h) Post Test C – 24 VDC (Volts Direct Current) Power Supply Test
 - i) Post Test D – Lamp
8. Press the **Start** key to begin the system test. While the tests are executing, the bottom display line changes to “RUNNING.”

At the completion of the tests, the test results are displayed. If a sub-test is successful, a “P” is displayed. If a sub-test fails, an “F” is displayed. If an “F” is displayed, the test has failed and service is required.

9. Press the **Exit** key to return to the SCANNER DIAGNOSTICS menu screen.

WRITE NVR

The WRITE NVR option is for use by the Customer Service Engineer only and requires the entry of the diagnostic password. It allows the Customer Service Engineer to modify the contents of the non-volatile memory of the Scan System.

If you select this option, the WRITE NVR screen is displayed. You cannot perform any functions in this screen. Press the **Exit** key to return to the SCANNER DIAGNOSTICS menu screen.

Below is an example of the WRITE NVR screen.

WRITE NVR			
SIZE:	4	ADDRESS:	D0
DATA:	ABCD4321	EXECUTE:	NO
USE . KEY FOR HEX DIGITS			

Write NVR Screen

RESET NVR DEFAULTS

The RESET NVR DEFAULTS option is for use by the Customer Service Engineer only and requires the entry of the diagnostic password. It allows the Customer Service Engineer to reset the NVR values to the factory default values.

If you select this option, the RESET NVR DEFAULTS screen is displayed. You cannot perform any functions in this screen. Press the **Exit** key to return to the SCANNER DIAGNOSTICS menu screen.

Below is an illustration of the RESET NVR DEFAULTS screen.

RESET NVR DEFAULTS	
WARNING: THIS FUNCTION DESTROYS NVR CONTENTS	
EXECUTE:	<input type="checkbox"/> YES <input checked="" type="checkbox"/> NO

Reset NVR Defaults Screen

SCANNER RELIABILITY METER

Select the SCANNER RELIABILITY METER option to view the current value of the usage meter maintained by the Scan System. The meter counts and displays the number of linear feet since the Scan System Fault Log was last cleared. The number of linear feet between fault occurrences is an indication of the reliability of the Scan System.

To run the SCANNER RELIABILITY METER diagnostic:

1. Press the **Menu** key. The MAIN MENU screen is displayed.
2. Press the **Next** key until DIAGNOSTICS is highlighted.

3. Press the **Enter** key to select DIAGNOSTICS. The DIAGNOSTICS menu screen is displayed.
4. Press the **Next** key until SCANNER DIAGNOSTICS is displayed.
5. Press the **Enter** key to select SCANNER DIAGNOSTICS. The SCANNER DIAGNOSTICS menu screen is displayed.
6. Press the **Next** key until SCANNER RELIABILITY METER is highlighted.
7. Press the **Enter** key to select SCANNER RELIABILITY METER. The SCANNER RELIABILITY METER screen is displayed.

The Scanner usage meter is intended for gathering data about the reliability of the scanning mechanism. This meter measures linear usage only. Units are displayed as either feet or meters depending on the display units selected for the machine. Refer to "Localization" in the "Main Menu" section for complete information about setting the display units.

Below is an example of the SCANNER RELIABILITY METER screen. In the example, the units are displayed as feet.

SCANNER RELIABILITY	
LINEAR SCAN (FT):	5678
COLOR (FT):	0

Scanner Reliability Screen

8. Press the **Exit** key to return to the SCANNER DIAGNOSTICS menu screen.

SCANNER FAULTS (ORDERED)

Select the SCANNER FAULTS (ORDERED) option to view the entries in the internal Scanner Fault Log.

To run the SCANNER FAULTS (ORDERED) diagnostic:

1. Press the **Menu** key. The MAIN MENU screen is displayed.
2. Press the **Next** key until DIAGNOSTICS is highlighted.
3. Press the **Enter** key to select DIAGNOSTICS. The DIAGNOSTICS menu screen is displayed.
4. Press the **Next** key until SCANNER DIAGNOSTICS is displayed.
5. Press the **Enter** key to select SCANNER DIAGNOSTICS. The SCANNER DIAGNOSTICS menu screen is displayed.
6. Press the **Next** key until SCANNER FAULTS (ORDERED) is highlighted.
7. Press the **Enter** key to select SCANNER FAULTS (ORDERED). The SCANNER FAULTS (ORDERED) screen is displayed.

The first line of the display contains the value of the internal Scanner Reliability Meter reading when the log was last cleared. If the log has never been cleared, the value is set to zero. This line scrolls with the log data.

The second and third lines contain the log entry information in columnar format. The first column indicates the log entry number. The second column indicates the fault code recorded in the log. The third column is the value of the internal Scanner Usage Meter at the time the fault was detected.

Below is an example of the SCANNER FAULTS (ORDERED) screen.

SCANNER FAULTS (ORDERED)		
↑	LAST CLEARED:	2001
↓	01	01-02 2476
	02	01-03 2402

Scanner Faults (Ordered) Screen

- Use the **Previous** or **Next** key to scroll through the listing.

The entries are presented three to a screen. You can view all valid entries in the Scanner Fault Log from this screen. Empty log entries are not displayed.

- When finished viewing the fault data, press the **Exit** key to return to the SCANNER DIAGNOSTICS menu screen.

SCANNER FAULTS (COUNT)

Select the SCANNER FAULTS (COUNT) option to view the last cleared faults.

To run the SCANNER FAULTS (COUNTS) diagnostic:

- Press the **Menu** key. The MAIN MENU screen is displayed.
- Press the **Next** key until DIAGNOSTICS is highlighted.
- Press the **Enter** key to select DIAGNOSTICS. The DIAGNOSTICS menu screen is displayed.
- Press the **Next** key until SCANNER DIAGNOSTICS is displayed.
- Press the **Enter** key to select SCANNER DIAGNOSTICS. The SCANNER DIAGNOSTICS menu screen is displayed.
- Press the **Next** key until SCANNER FAULTS (COUNTS) is highlighted.
- Press the **Enter** key to select SCANNER FAULTS (COUNTS). The SCANNER FAULTS (COUNTS) screen is displayed.

The first line of the display contains the value of the internal Scanner Reliability Meter reading when the log was last cleared. If the log has never been cleared, the value is set to zero. This line scrolls with the log data.

The second and third lines contain the log entry information in columnar format. The first column indicates the log entry number. The second column indicates the fault code recorded in the log. The third column is the value of the internal Scanner Usage Meter at the time the fault was detected.

Below is an example of the SCANNER FAULTS (COUNTS) screen.

SCANNER FAULTS (COUNTS)		
↑	LAST CLEARED:	2001
01	01-02	2476
02	01-03	2402
↓		

Scanner Faults (Counts) Screen

- Use the **Previous** or **Next** key to scroll through the listing.

The entries are presented three to a screen. You can view all valid entries in the Scanner Fault Log from this screen. Empty log entries are not displayed.

- When finished viewing the fault data, press the **Exit** key to return to the SCANNER DIAGNOSTICS menu screen.

CLEAR SCANNER FAULT LOG

The CLEAR SCANNER FAULT LOG option is for use by the Customer Service Engineer only and requires the entry of the diagnostic password. It allows the Customer Service Engineer to erase the contents of the Scanner Fault Log.

If you select this option, the CLEAR SCANNER FAULT LOG screen is displayed. You cannot perform any functions in this screen. Press the Exit key to return to the SCANNER DIAGNOSTICS menu screen.

Below is an illustration of the CLEAR SCANNER FAULT LOG screen.

CLEAR SCANNER FAULT LOG	
WARNING: THIS FUNCTION	
DESTROYS ALL LOG MESSAGES	
EXECUTE:	↑ NO

Clear Fault Log Screen

CLEAN CAL ZONE

The CLEAN CAL ZONE (Clean Calibration Zone) provides the user with a quick way to move the Calibration Motor to the cleaning position. There are two selections CLEANING POSITION AND HOME POSITION.

CLEAN CAL ZONE	
POSITION:	↑ CLEANING POSITION

Clean Cal Zone Screen

COMPONENT TESTS

The COMPONENT TESTS option of the SCANNER DIAGNOSTICS menu provides a sub-menu of the following menu choices:

- MOTOR SPEED - Enables the Customer Service Engineer to adjust the Scan System motor speed and correct magnification errors in the process direction. The diagnostic password is required for this function.
- LEAD EDGE/TRAIL EDGE - Enables you to execute the lead edge/trail edge diagnostic.
- SENSORS - Enables you to display the current state of the Scan System optical paper sensors and the thick document sensor.
- MOTOR COMMUNICATIONS - Enables a document motor communications loopback test to assist in diagnosing a Scan System problem.
- DOCUMENT MOTOR - Enables you to stop and start the document handler motor.
- LAMP - Enables you to turn the lamp on and off and receive a feedback from the illumination sensor.
- CALIBRATION MOTOR - Enables you to test the calibration zone motor.

To access the COMPONENT TESTS menu:

1. Press the **Menu** key. The MAIN MENU screen is displayed.
2. Press the **Next** key until DIAGNOSTICS is highlighted.
3. Press the **Enter** key to select DIAGNOSTICS. The DIAGNOSTICS menu screen is displayed.
4. Press the **Next** key until SCANNER DIAGNOSTICS is highlighted.
5. Press the **Enter** key to highlight SCANNER DIAGNOSTICS. The SCANNER DIAGNOSTICS menu screen is displayed.
6. Press the **Next** key until COMPONENT TESTS is highlighted.
7. Press the **Enter** key to select COMPONENT TESTS. The COMPONENT TESTS menu screen is displayed. The black arrows indicate that the menu contains more options than are visible. The selected option is highlighted.

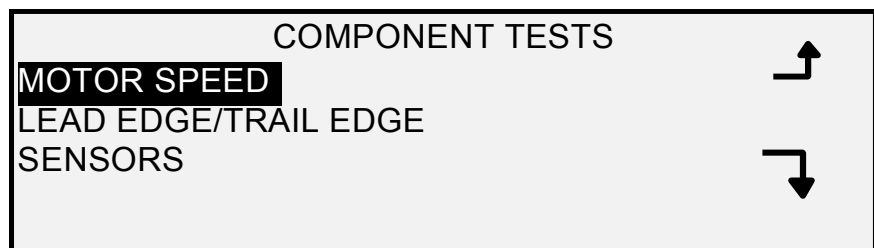

Component Tests Screen

8. Press the **Previous** or **Next** key to scroll through the list of options.
9. When the desired option is highlighted, press the **Enter** key to select the option. The screen for the selected option is displayed.

MOTOR SPEED

The MOTOR SPEED option is for use by the Customer Service Engineer only and requires the entry of the diagnostic password. It allows the Customer Service Engineer to adjust the Scan System motor speed and correct magnification error in the process direction.

If you select this option, the MOTOR SPEED screen is displayed. You cannot perform any functions in this screen. Press the **Exit** key to return to the COMPONENTS TESTS menu screen.

Below is an example of the MOTOR SPEED screen.

MOTOR SPEED	
EXPECTED LENGTH	610
MEASURED LENGTH:	0
PRESS START TO ADJUST SPEED	

Motor Speed Screen

LEAD EDGE/TRAIL EDGE

Select the LEAD EDGE/TRAIL EDGE option to execute the lead edge/trail edge adjustment diagnostic.

To run the LEAD EDGE/TRAIL EDGE diagnostic:

1. Press the **Menu** key. The MAIN MENU screen is displayed.
2. Press the **Next** key until DIAGNOSTICS is highlighted.
3. Press the **Enter** key to select DIAGNOSTICS. The DIAGNOSTICS menu screen is displayed.
4. Press the **Next** key until SCANNER DIAGNOSTICS is displayed.
5. Press the **Enter** key to select SCANNER DIAGNOSTICS. The SCANNER DIAGNOSTICS menu screen is displayed.
6. Press the **Next** key until COMPONENT TESTS is highlighted.
7. Press the **Enter** key to select COMPONENT TESTS. The COMPONENTS TESTS menu screen is displayed.
8. Press the **Enter** key to select LEAD EDGE/TRAIL EDGE. The LEAD EDGE/TRAIL EDGE ADJUSTMENT screen is displayed.

LEAD EDGE/TRAIL EDGE ADJUSTMENT
PRESS START TO BEGIN

Lead Edge/Trail Edge Adjustment Screen

9. Insert a black sheet (8.5 X 11) of paper into the Scan System.
10. Press the **Start** key to begin the diagnostic. When the diagnostic completes, the last line of the display is replaced with a status

line indicating PASS or FAIL. The last line may also display as NO RESPONSE FROM SCANNER if the Scan System does not process the request within the timeout period.

11. Press the **Enter** key to return to the COMPONENT TESTS menu screen.

SENSORS

Select the SENSORS option to display the current state of the Scan System optical paper sensors, calibration home sensor, and the thick document sensor.

To display the status of the sensors:

1. Press the **Menu** key. The MAIN MENU screen is displayed.
2. Press the **Next** key until DIAGNOSTICS is highlighted.
3. Press the **Enter** key to select DIAGNOSTICS. The DIAGNOSTICS menu screen is displayed.
4. Press the **Next** key until SCANNER DIAGNOSTICS is displayed.
5. Press the **Enter** key to select SCANNER DIAGNOSTICS. The SCANNER DIAGNOSTICS menu screen is displayed.
6. Press the **Next** key until COMPONENT TESTS is highlighted.
7. Press the **Enter** key to select COMPONENT TESTS. The COMPONENTS TESTS menu screen is displayed.
8. Press the **Enter** key to select SENSORS. Depending on the Document Feed-in Tray configuration, a SENSORS screen is displayed. The screen below is with the Productivity Tray. When a sensor is activated the icon **●** is filled in.

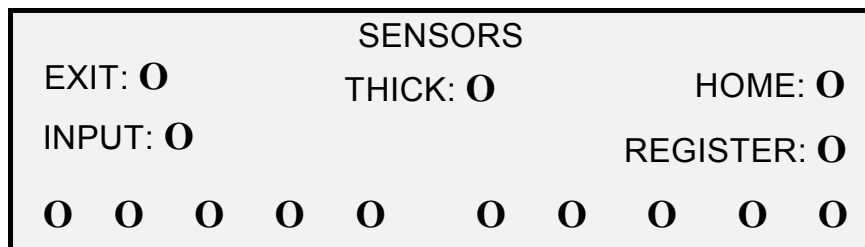

Sensors Screen

9. To check the status of the optical paper sensors:
 - a) Raise the Thickness Lever to enable an 8.5 X 11 sheet of paper to be inserted into the Scan System.
 - b) Insert the sheet of paper centered on the Scan System and slowly push the paper into the Scan System to check the INPUT, REGISTER, and EXIT sensors.

The sensors are located underneath the top cover. The photo below shows the location of each of the sensors on the Document Feed Tray.

Sensor Locations on the Synergix Scan System

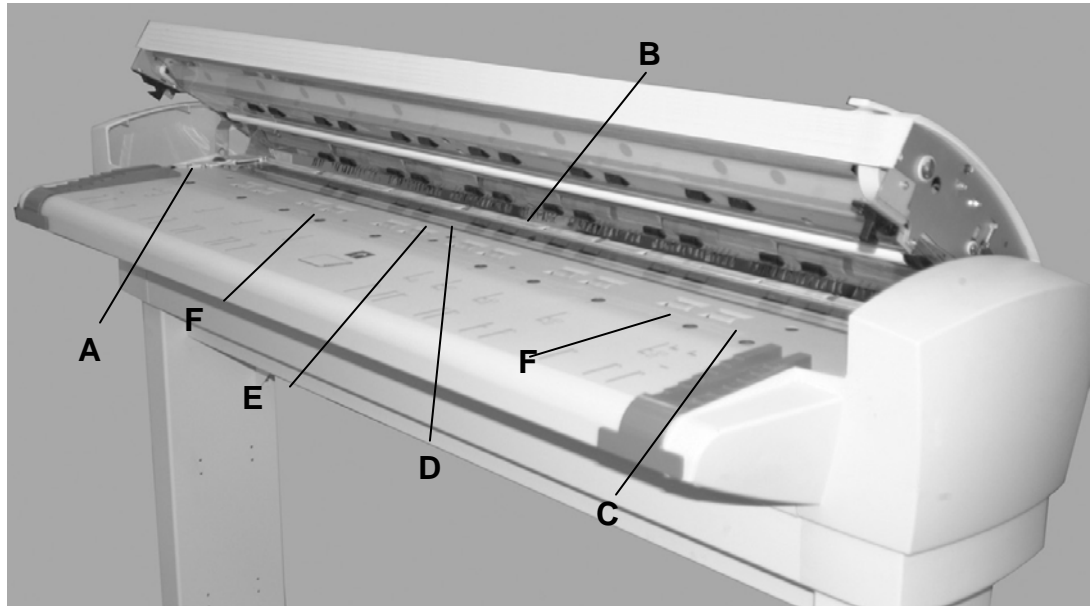

A: Left Oversize Document Sensor



B: Exit

C: Right Oversize Document Sensor

D: Register

E: Input

F: Discrete Width Sensors (Four on left and four on right)

- c) Observe the Display. When the sensor is activated the icon  is filled in.
 - d) Move the sheet of paper fully to the left and right to check the LEFT and RIGHT sensors.
10. To check the status of the thick document sensor:
- a) Raise the Thick Document Lever. When the sensor is activated the icon  is filled in.
 - b) When finished viewing the status of the thick document sensor, lower the Thick Document Lever.
11. To check the status of HOME sensor.
- a) Raise the Document Handler just enough to access the Calibration Roll drive gear and still be able to see the Display.
 - b) Rotate the Calibration Roll one full revolution. The status will change from NO to YES if the sensor is okay.

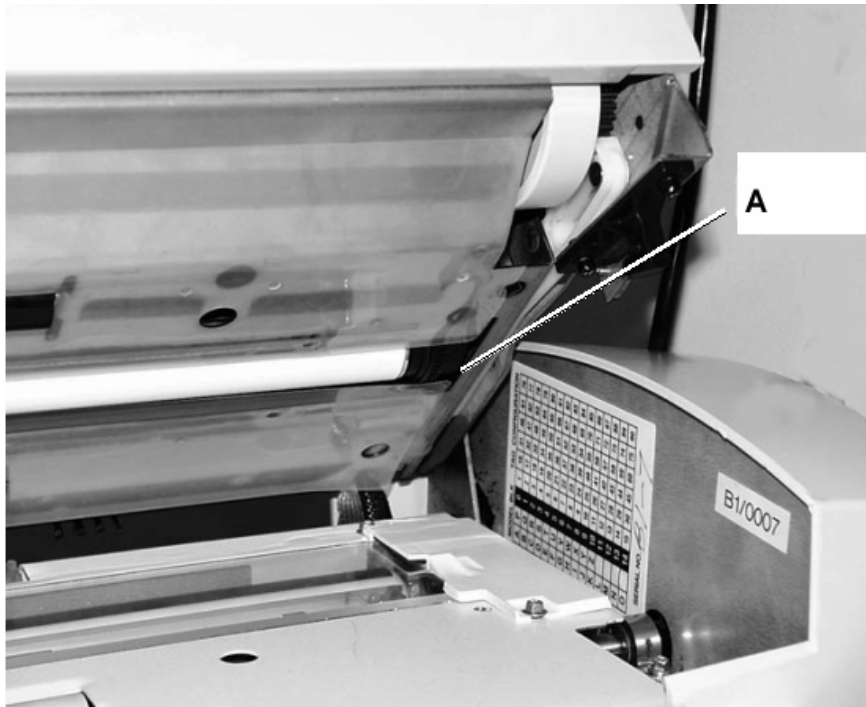

A: Calibration Roll Drive Gear

12. Press the **Exit** key to return to the COMPONENT TESTS menu screen.

MOTOR COMMUNICATIONS

The MOTOR COMMUNICATIONS test is for use by the Customer Service Engineer only. However, user access is permitted in the event that Service instructs the user to perform this test. This test allows the Customer Service Engineer or user, if directed by the Service Engineer, to run a motor communications loopback test to assist in diagnosing a Scan System problem.

When the Start key is pressed, the message changes to STATUS. After the test completes, either a PASS or FAIL status is displayed. If the status is FAIL, some test values will be displayed, and Service will be required.

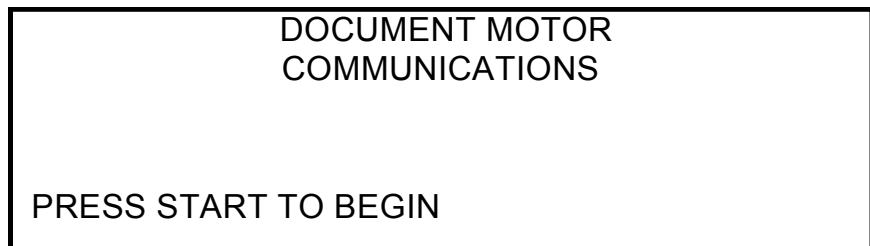

Document Motor Communications Screen

DOCUMENT MOTOR

This option allows you to stop and start the document handler motor. When you select this option, the DOCUMENT MOTOR screen is displayed.

To run the DOCUMENT MOTOR diagnostic:

1. Press the **Menu** key. The MAIN MENU screen is displayed.

2. Press the **Next** key until DIAGNOSTICS is highlighted.
3. Press the **Enter** key to select DIAGNOSTICS. The DIAGNOSTICS menu screen is displayed.
4. Press the **Next** key until SCANNER DIAGNOSTICS is displayed.
5. Press the **Enter** key to select SCANNER DIAGNOSTICS. The SCANNER DIAGNOSTICS menu screen is displayed.
6. Press the **Next** key until COMPONENT TESTS is highlighted.
7. Press the **Enter** key to select COMPONENT TESTS. The COMPONENTS TESTS menu screen is displayed.
8. Press the **Next** key until DOCUMENT MOTOR is highlighted.
9. Press the **Enter** key to select DOCUMENT MOTOR. The DOCUMENT MOTOR screen is displayed.

DOCUMENT MOTOR	
MOTOR: OFF	SPEED: .125
DIRECTION:	↑
	FORWARD

Document Motor Screen

10. Turn the motor on.
 - a) Press the **Previous** or **Next** key to highlight MOTOR.
 - b) Press the **Enter** key to confirm your selection.
 - c) Press the **Previous** or **Next** key to select ON. The choices are ON and OFF.
 - d) Press the **Enter** key to confirm your selection.
11. Select the motor speed.
 - a) Press the **Previous** or **Next** key to highlight SPEED.
 - b) Press the **Enter** key to confirm your selection.
 - c) Press the **Previous** or **Next** key to select the desired motor speed. The choices are .125, .250, .500, .750, 1, 1.5, 2, 3 and 4.
 - d) Press the **Enter** key to confirm your selection.
12. Select the motor direction.
 - a) Press the **Previous** or **Next** key to highlight DIRECTION.
 - b) Press the **Enter** key to confirm your selection.
 - c) Press the **Previous** or **Next** key to select the desired motor direction. The choices are FORWARD and REVERSE.
 - d) Press the **Enter** key to confirm your selection.
13. Press the **Start** key to activate the motor.
14. Press the **Exit** key to return to the COMPONENT TESTS menu screen.

CALIBRATION MOTOR

Select the CALIBRATION MOTOR option to set the calibration zone motor.

To run the CALIBRATION MOTOR diagnostic:

1. Press the **Menu** key. The MAIN MENU screen is displayed.
2. Press the **Next** key until DIAGNOSTICS is highlighted.
3. Press the **Enter** key to select DIAGNOSTICS. The DIAGNOSTICS menu screen is displayed.
4. Press the **Next** key until SCANNER DIAGNOSTICS is displayed.
5. Press the **Enter** key to select SCANNER DIAGNOSTICS. The SCANNER DIAGNOSTICS menu screen is displayed.
6. Press the **Next** key until COMPONENT TESTS is highlighted.
7. Press the **Enter** key to select COMPONENT TESTS. The COMPONENTS TESTS menu screen is displayed.
8. Press the **Next** key until CALIBRATION MOTOR is highlighted.
9. Press the **Enter** key to select CALIBRATION MOTOR. The CALIBRATION MOTOR screen is displayed.

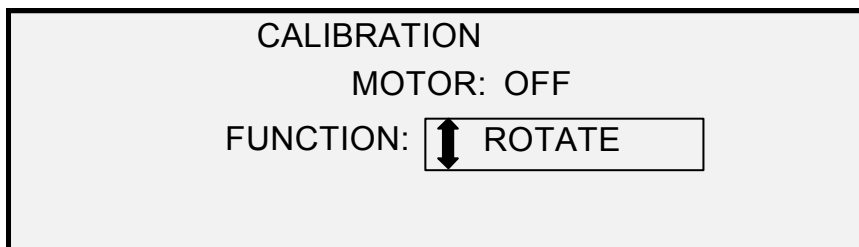

Calibration Screen

10. Press the **Previous** or **Next** key to select FUNCTION.
11. Press the **Enter** key to select FUNCTION.
12. Press the **Previous** or **Next** key to highlight the desired function. The choices are GO TO WIDTH, GO TO CALIBRATE, GO TO HOME, FIND HOME, and ROTATE.
13. Press the **Enter** key to confirm your selection.
14. Press the **Previous** or **Next** key to highlight MOTOR.
15. Press the **Enter** key to confirm your selection.
16. Press the **Previous** or **Next** key to highlight ON. The choices are ON and OFF. The requested operation will execute.

If a GO TO or FIND function has been selected, the MOTOR field will be automatically set to OFF when the MOTOR field is once again selected. If the ROTATE function has been selected, the motor will run continuously until you set the MOTOR field to OFF.

NOTE: If the Scan System encounters a failure accessing the calibration motor function, the fourth line of the display will read "FAILURE CODE:" followed by a two-digit hexadecimal number. The fourth line may also

display NO RESPONSE FROM SCANNER if the Scan System does not respond to the test request.

17. Press the **Exit** key to return to the Component Tests menu screen.

READ NVR

The READ NVR option allows the examination of the contents of the non-volatile RAM (NVR). The service center may ask you to provide this information when calling for service.

To run the READ NVR diagnostic:

1. Press the **Menu** key. The MAIN MENU screen is displayed.
2. Press the **Next** key until DIAGNOSTICS is highlighted.
3. Press the **Enter** key to select DIAGNOSTICS. The DIAGNOSTICS menu screen is displayed.
4. Press the **Next** key until SCANNER DIAGNOSTICS is displayed.
5. Press the **Enter** key to select SCANNER DIAGNOSTICS. The SCANNER DIAGNOSTICS menu screen is displayed.
6. Press the **Next** key until READ NVR is highlighted.
7. Press the **Enter** key to select READ NVR. The READ NVR screen is displayed. An "xx" displays for all the NVR values.

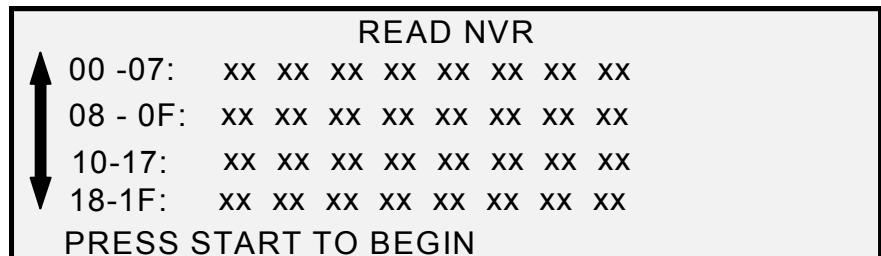

Read NVR Screen

8. Press the **Start** key to display the actual values.
9. Press the **Previous** or **Next** key to scroll through the values. There are 16 rows of values in all.
10. Press the **Exit** key to return to the SCANNER DIAGNOSTICS screen.

PASSWORD

The PASSWORD option of the DIAGNOSTICS menu is for use by the Customer Service Engineer only. It allows the Customer Service Engineer to enter the password for access to password-protected diagnostic functions.

If you select this option, the PASSWORD screen is displayed. You cannot perform any functions in this screen. Press the Exit key to return to the COMPONENT TESTS menu screen.

PASSWORD
ENTER PASSWORD:

Password Screen

Job Accounting

Job Accounting

NOTE: The JOB ACCOUNTING feature is an optional feature on the WIDE FORMAT COPY SYSTEM, requiring a Feature Key to activate it. If you obtain this feature, the System Administrator can enable it at any time on the WIDE FORMAT COPY SYSTEM by sending a special feature key file to the Printer. Once the feature is enabled, it remains enabled (even following upgrades to the system software). Contact your XEROX sales representative for ordering information.

Overview

JOB ACCOUNTING is a SYSTEM ADMINISTRATION menu option. Access to it is restricted to the system administrator and requires the entry of the system administration password.

The JOB ACCOUNTING option allows Scan System and Printer usage to be recorded in user defined account numbers. Usage is expressed as the area (not the length) of the media scanned or used.

Job Accounting for the Scan System is controlled through the Scan System Control Panel. For the WIDE FORMAT COPY SYSTEM 8825, 8830, 8850, 510 Series, 6204, and 721P, Job Accounting for the Printer can be set from either the Printer Control Panel or the Web-based Print Management Tool. For the WIDE FORMAT COPY SYSTEM 6030/6050, Job Accounting for the Printer can be set from the Web Print Management Tool only.

The Web Print Management Tool consists of special Web pages located in the Controller. They are accessible through either the Microsoft Internet Explorer or the Netscape browsers. Version 4.0 or higher is required for proper results. Other Web browsers are not supported and may or may not work correctly.

Job Accounting can be set on the Scan System or Printer to one of three modes. The modes are ENABLED, OPTIONAL, and DISABLED.

The Scan System and Printer share a common job based accounting database referred to as the FreeFlow Accxes Account Management Tool. This Account Management Tool is composed of two

components, an external accounting software package, installed on an Administrative workstation, and the job log file that is created on the Controller. The Account Management Tool creates all accounts, assigns the user IDs, gathers all the account data, manages all the accounts, and provides account reports.

NOTE: For full information on the new job accounting refer to the Account Management Tool help files.

Job Accounting Mode menu

The JOB ACCOUNTING MODE menu allows the system administrator to access the function for enabling or disabling the Job Accounting Mode at the Scan System. Access is restricted to the System Administrator and requires the entry of the system administration password. It provides a sub-menu of the following choices:

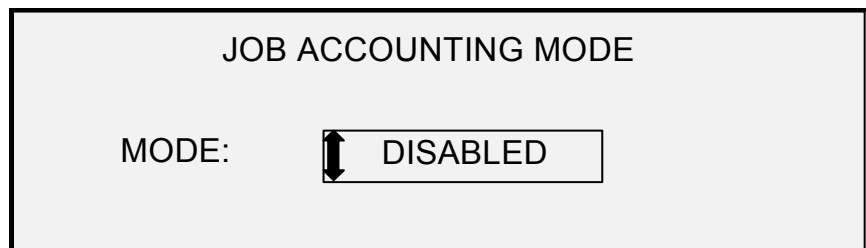

Job Accounting Mode Screen

The job accounting modes are as follows:

- **ENABLED** - all jobs require a System Administrator assigned valid account number,
- **OPTIONAL** - a System Administrator assigned valid account number is optional for any job
- **DISABLED** - jobs do not require an account number.

To access the Job Accounting menu:

1. Select the **Menu** key.
2. Select **System Administration > Job Accounting Mode**
3. Press the **Previous** or **Next** key to scroll through the list of options.
4. When the desired option is highlighted, press the **Enter** key to select the option. The menu or screen for the selected option is displayed.

Submitting jobs

Job Accounting is enabled or disabled on the Scan System and the Printer independently. Job submission from either device depends on the Job Accounting mode set for the device.

**From the Scan
System Control Panel**

If Job Accounting is ENABLED, the following screen is displayed:

PLEASE ENTER USER: <input type="text"/>

Job Accounting Please Enter User Id Screen

NOTE: If Job Accounting Mode is enabled as *OPTIONAL*, the phrase "OR PRESS ENTER" will display at the bottom of the screen. No *USER ID* is required. Press **Enter** to continue.

You must enter the User ID code assigned to you by the System Administrator. The Account ID can be alphanumeric. To enter a numeric account, press a numeric key once. To enter an alpha character, press the numeric key associated with the desired letter. Press the numeric key twice to get the first letter, three times for the second letter, etc. Pressing a key six to eight times will provide the lower case version of the respective letter. Pressing the **Next** key moves the cursor to the right, which will add a blank space or allow entry of a character. Pressing the **Previous** or **C/CA** keys move the cursor to the left deleting the character.

Then press ENTER to display the ACCOUNT screen and enter the account number assigned to you using the numeric keys. Once you do so, the READY screen is displayed. You can now scan and print copies.

PLEASE ENTER ACCOUNT: <input type="text"/>
--

Job Accounting Please Enter Account Id Screen

If Job Accounting Mode is *OPTIONAL*, the above screen will not be displayed. In either case, the READY screen is displayed after you press the Enter key. You can now scan and print copies.

If you entered a valid account number, all usage is charged to that account and is also accumulated under Generic User ID and Account ID code. If you did not enter an account number, usage is accumulated only in the System Account under Generic User ID and Account code.

For both the *ENABLED* and *OPTIONAL* modes, if you enter an invalid account, an error message indicated below is displayed. You cannot access the READY screen if an invalid number is entered

ERROR:
INVALID USER OR ACCOUNT

Job Accounting Error Screen

Over the network

When Job Accounting Mode is enabled the system examines the incoming job for a valid account number. If none is found, the job is rejected, and an error page is printed.

NOTE: *The print drivers and the FreeFlow Accxes Client Tools (ACT) software all have a feature that allows insertion of a job accounting number. Refer to the help files for these software products for details.*

If Job Accounting is optionally ENABLED, remote print jobs will be printed whether or not they have a valid account number. If a valid account number is present, the job will be charged to the user account and also accumulated to a system Generic User Id and Account Code. If no account number is present, the job is charged to a system Generic User Id and Account Code. This is the same as when Job Accounting is DISABLED.

Terminating use under an account

Once a valid job account number has been entered from the Scan System Control Panel, all use of the WIDE FORMAT COPY SYSTEM Scan System is charged to that account. All usage continues to accumulate to that account until one of the following occurs:

- You press the **Exit** key while either the READY screen or a fault screen is displayed.
- The FEATURE timer times out due to no activity. The default value is 5 minutes, but this value can be changed. Refer to "TIMERS" in the "Main Menu" section for information about changing the value.

When an account is no longer in use, the PLEASE ENTER ACCOUNT screen is displayed.

NOTE: *To avoid incorrect accounting, always ensure that the PLEASE ENTER USER screen is displayed before leaving the WIDE FORMAT COPY SYSTEM for the next operator. Press the Exit key to obtain this screen.*

Cleaning and maintenance - Scan System

Cleaning and maintenance - Scan System

For the Scan System to do its best job, the Platen Glass, Document Drive Rolls, Backer Roll, Calibration Strip, and Document Feed Tray must be kept clean. This requires some daily and monthly cleaning and maintenance activities.

Daily activities:

- Clean the Platen Glass, Document Drive Rolls, and Backer Roll. See the "Cleaning the Platen Glass and Document Drive Rolls" section on the next page.
- Inspect the Document Feed Tray and clean as required.

Monthly activities:

- Clean the Calibration Strip. See the "Cleaning the Calibration Strip" section.
- Inspect the Platen Glass for chips and scratches. If the Platen Glass is chipped or scratched, and these defects are visible in the scanned images, call XEROX service.

The following illustration depicts the Scan System components that require cleaning.

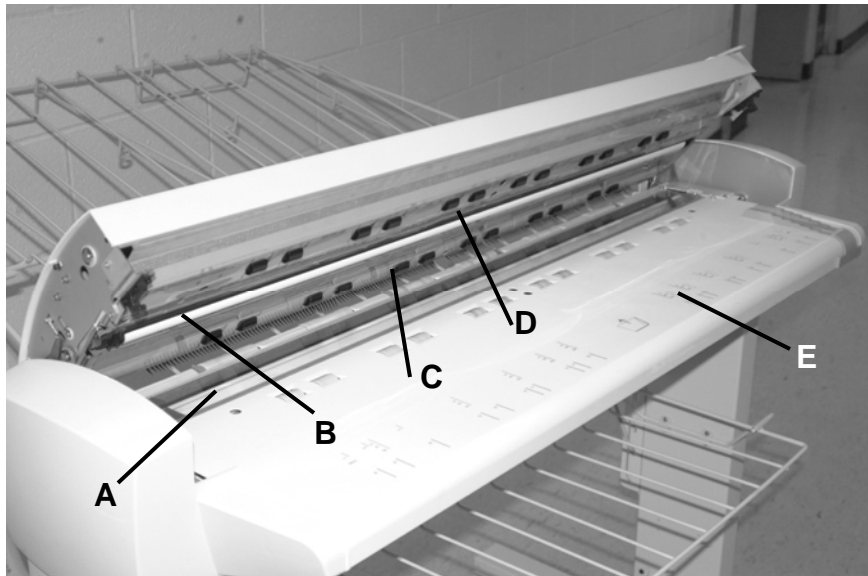

A: Platen Glass

B: Backer Roll

C: Document Drive Rolls (rear)

D: Document Drive Rolls (front)

E: Document Feed Tray

Cleaning the Platen Glass, Document Drive Rolls, and Backer Roll

Perform the following steps daily:

1. Open the Top Cover.
2. Dampen a clean, lint-free towel (600S4372) with platen glass cleaning fluid (Xerox 43P81).
3. Wipe the Platen Glass with the towel.
4. Visually inspect the Platen Glass to ensure that all dirt, glue, and other residue have been removed.
5. Place a small amount of the cleaning fluid on the towel and clean the front and rear Document Drive Rolls. Rotate the Rolls as you clean them to ensure that the entire roll surface is clean.
6. Place a small amount of the cleaning fluid on the towel and wipe the white Backer Roll.

NOTE: The Backer Roll is located on the underside of the Top Cover. The Backer Roll may rotate as you clean it. This is normal behavior.

7. Close the Top Cover.

Cleaning the Calibration Strip

Perform the following steps monthly:

1. Press the **Menu** key, then scroll to the Diagnostic and press the **Enter** key.
 - Scroll to CLEAN CAL ZONE and press the **Enter** key.
 - Press the **Enter** key to select CLEANING POSITION.

NOTE: *The Top Cover must be closed while running this test.*

2. Raise the Top Cover.
3. Inspect the Calibration Strip.
4. Place a small amount of platen glass cleaning fluid (Xerox 43P81) on a clean, lint-free towel (600S4372) and clean the Calibration Strip.
5. Lower the Top Cover.
6. Press the **Enter** key to select HOME POSITION.
7. Press the **Exit** key to exit the CLEAN CAL ZONE.
8. Press the **Menu** key to return to the READY screen. The Calibration Strip automatically returns to its home position.

Problem solving

Problem solving

This section contains a problem-solving table and an error message table for help in resolving problems with the WIDE FORMAT SCAN SYSTEM.

Identify the problem you are experiencing and follow the step(s) indicated in the table for fixing the problem. If the procedures do not restore normal Scan System operation, call for service. For help in solving problems with the Printer or the Printer media, refer to the applicable Printer Operator Manual.

Table 7. Problem Solving Table

Problem	First solution to try	Second solution to try	Third solution to try
Power on			
The Exposure Lamp does not illuminate when the Scan System is switched on.	Ensure that the Power Cord is connected to the Scan System and to the correct power source.	Check that the Power On/Off Switch is in the on (I) position.	Call for Service.
The Scan System Control Panel continuously displays a clock face and the System does not initialize.	Ensure that the IEEE 1394 cable is connected to both the Scan System and the Controller. Check that the cable was not forced in the connector incorrectly.	For all controllers, except the YKE and YKE-N, ensure that the DDS option is set to Enabled. NOTE: For the 8825/8830, and 6030/6050 Printers, you can change this setting from either the CONTROLLER CONFIGURATION screen of the Printer Control Panel, or in the Web Print Management Tool, select Configuration > Printer > Printer Setup > DDS Enabled. Wait 30 seconds. Then power the system off then on (rebooted). For the 721P Printer, this change can be made from the Web Print Management Tool only.	

Problem	First solution to try	Second solution to try	Third solution to try
Constant Scanner NOT READY message	Lift the Document Handler Switch off the Scan System Switch off the Printer/Controller Switch on the Scan System and wait for the display to indicate "P" Switch on the Controller, then the Printer.	Call for Service.	
Corrupted or unclear messages after powering the Scan System off, then on.	Ensure the System was powered off, then on correctly: Switch off the Scan System. Switch off the Printer/Controller. Switch on the Scan System and wait for the display to indicate P . Switch on the Controller then Printer.	Call for Service.	
Scan System control			
The Scan System does not scan when a document is inserted.	Press the Start key or enable AUTOSCAN. See "Scan System control" in the "Main Menu" section for more information.		
The Scan System measures the width of the original incorrectly. The copy is either wider than the original, or the copy is clipped.	Clean the Platen Glass. Open the Upper Document Transport. Look for a row of 10 holes across the Feed-in Shelf next to the Platen Glass. If the holes are present, press the Menu key and scroll to CONFIGURATION>SCAN SYSTEM CONTROL> MODE and check if mode is set to PRODUCTIVITY. If it is, ensure that the media series setting for the PRODUCTIVITY matches the media series being used in the Printer. If the media series matches, set the MODE to AUTOWIDTH/AUTOCENTER and call for service.	Turn AUTOWIDTH off. See "Scan System Control" in the "Main Menu" section for more information.	Run the diagnostic test to validate which width detection sensors are working correctly. Select Main button > Diagnostics > Scanner Diagnostics > Component Tests > Sensors.
When the Scan System is set to exit to the front, the document is difficult to remove from the Scan System.	Raise the Thick Document Lever to release the document. Be sure to lower the Thick Document Lever before making the next copy/scan.	Set the Scan System to exit to the rear. See "Scan System Control" in the "Main Menu section" for more information.	
Document feed			

Problem	First solution to try	Second solution to try	Third solution to try
The Scan System will not accept a thin document (less than .03 in (1 mm) thick).	Ensure that both the Scan System and the Printer are powered up and initialized. Ensure that the Thickness Lever is adjusted correctly for the document being scanned.	If the thin document has a torn or dog-eared lead edge, try feeding a different edge first.	Insert the document in a document carrier.
The Scan System will not accept a thick document.	Ensure that both the Scan System and the Printer are powered up and initialized.	Set the Thick Document Lever to its next higher setting. Thick documents may require operator assistance.	
The Scan System measures the width of the original incorrectly. The copy is either wider than the original or the copy is clipped.	Refer to this document's section "Cleaning the Platen Glass, Document Drive Rolls and Backer Roll". Wipe the Document Feed Tray with anti-static fluid. See the second item above in Scan System Control.	Turn the AUTOWIDTH off. See "Scan System Control" in the "Main Menu" section for more information.	
When the Scan System is set to exit to the front, the document is difficult to remove from the Scan System.	Raise the Thick Document Lever to release the document. Be sure to lower the Thick Document Lever before making the next copy/scan.	Set the Scan System to exit to the rear. See "Scan System Control" in the "Main Menu" section of this document for more information.	
Width detection failed when scanning transparent documents. Width sensors in most cases will not detect transparent documents.	Enter the document width.	Turn AUTOWIDTH off and refer to "Scan System Control" in the Main Menu.	
Not Ready Media Jam	Refer to "Cleaning the Platen Glass, Document Drive Rolls, and Backer Roll". Wipe the Document Feed Tray with anti-static fluid.	If the document is folded, worn or damaged, use a document carrier or try feeding a different edge.	For thick documents, set the Thick Document Lever to its next higher setting. Thick documents may require operator assistance.
The Scan System does not position the document correctly before scanning.	Ensure that you are inserting the document correctly. Center the document between the marks on the Document Feed Tray. Smoothly insert the document into the feed mechanism so that the lead edge of the document is against the rollers before the Scan System begins to stage the document.	Check the operation of the optical paper sensors. See "Sensors" in the "Main Menu" section for more information.	
Image quality			
Vertical lines and streaks are visible in the copy.	Clean the Platen Glass.		

Problem	First solution to try	Second solution to try	Third solution to try
Visible document edges on the copy.	Try a lighter Contrast setting.		
Dark spots or smudges appear on the copy.	Clean the Platen Glass.	Inspect the original and clean it if necessary.	Adjust the Copy setting for best image quality.
The copy image is too light.	Adjust the Copy setting for best image quality.	Rotate the original 90 degrees.	
The image density on the copy varies from light to dark.	Rotate the original 90 degrees.	Adjust the Copy setting for best image quality.	
Copies made in Photo mode have geometric patterns.	Set the Original, Type to Normal and the Background Suppression to Off.	Set Original, Type to Line and Background Suppression off.	Try a lighter Contrast setting.
Fine lines on the original do not appear on the copy when the image size is reduced.	Enable the LINE MODE LINE PRESERVATION option. See "Imaging" in the "Main Menu" section for more information.	Adjust the Copy setting for best image quality.	
Gray areas appear in the copy at the location of creases or folds in the original document.	Refold the document in the reverse direction to flatten the creases or folds.		
Error messages			
An error message is displayed on the Scan System Control Panel.	Locate the message in Table 8, "Error Code Messages," in this section and perform the corrective action indicated.		

Table 8. Error Code Messages Table

Error message	Probable cause	Corrective action
40000001: ERROR ACCOUNTING DISK FULL	The Job Log File size has reached the maximum space allocated for it.	Contact your System Administrator.
40000002: ERROR	The number of Job Records in the Job Log File has reached the maximum as defined by the FreeFlow Accxes Account Management Tool.	Contact your System Administrator.
CONTROLLER FAULT - 50000001	The Controller has developed a "memory is full" internal fault. Large documents using Auto Reduction/Enlargement or Auto-Rotate may cause this fault. Also, Photo and Mixed/Custom modes require significantly more memory than Line mode.	Remove the document. Press Start to print the job.
CONTROLLER FAULT - 50000002	The Controller has developed a "memory is full" internal fault. Large documents using Auto Reduction/Enlargement or Auto Rotate may cause this fault. Also, Photo and Mixed/Custom modes require significantly more memory than Line mode.	Remove the document. Wait for previous scans to finish printing. End the current set or print it if a set is in progress. Rescan the document.

CONTROLLER FAULT - 50000003 CONTROLLER FAULT - 50000004 CONTROLLER FAULT - 50000005	A task controlling the Scan System received an unrecognized request from the task controlling the Scan System control panel.	Power off the System. Check that all cables are connected correctly. Power on the System. See the "Powering off the System" and "Powering on the System" sections for more information.
CONTROLLER FAULT - 50000007	A software problem was encountered in controlling the Scan System.	Power off and power on the System. See the "Powering off the System" and "Powering on the System" sections for more information.
CONTROLLER FAULT - 50000008 - DOCUMENT JAM	A document jam has occurred in the Scan System.	Remove the jammed document. Scan the document again.
CONTROLLER FAULT - 50000011 - SCANNED IMAGE LOST	FreeFlow Accxes firmware supports a maximum of 128 active jobs in the printer queue. Scans made after the maximum were refused and a scan error was declared.	Allow the jobs in the queue to print, and then rescan the document. FreeFlow Accxes firmware reserves 8 jobs for Scan-to-Net and copy jobs. This provides sufficient capability for scans and copy jobs even when there is a high volume of print jobs on the network.
SCAN SYSTEM FAULT - 5000000B - CHECK SCAN SYSTEM VERIFY SCAN SYSTEM IS POWERED AND PROPERLY CONNECTED	A fault has occurred in communicating with the Scan System.	Check that the IEEE 1394 cable is properly connected at both ends. Check that the Scan System is still connected to the AC power and is still switched on. Power off and power on the System. See the "Powering off the System" and "Powering on the System" sections for more information.
CONTROLLER FAULT - 50000012 - MEMORY FULL CONTROLLER FAULT - 50000013 - MEMORY FULL	The file system or memory is full.	Retrieve or delete some documents to create more space. Then rescan the document.
CONTROLLER FAULT - 50000014 - MEMORY FULL	Documents were scanned too fast. Memory is full.	Wait for previously scanned documents to be processed and stored on the hard disk. Then scan the current document again.
CONTROLLER FAULT - 50000015	An error occurred saving the scanned image to a disk.	Do not scan until the interrupted job is finished. Check that the SCSI cable or IEEE 1394 cable is connected correctly.
CONTROLLER FAULT - 50000017	FTP file transfer failed.	On the Web Print Management Tool, check the FTP destination settings by selecting Printer Defaults > Utilities > Scan Destinations.
SCAN SYSTEM MESSAGE: "DISK IMAGE OVERWRITE IN PROGRESS"	When a user selects the On-Demand Image Overwrite on the Web Print Management Tool, the FreeFlow Accxes controller will reboot, causing the message on the printer and scan system during the reboot.	The message will be gone after the reboot sequence updates the scan system in the normal fashion.

Error message	Probable cause	Corrective action
40000001: ERROR ACCOUNTING DISK FULL	The Job Log File size has reached the maximum space allocated for it.	Contact your System Administrator.
40000002: ERROR	The number of Job Records in the Job Log File has reached the maximum as defined by the FreeFlow Accxes Account Management Tool.	Contact your System Administrator.
CONTROLLER FAULT - 50000001	The Controller has developed a "memory is full" internal fault. Large documents using Auto Reduction/Enlargement or Auto-Rotate may cause this fault. Also, Photo and Mixed/Custom modes require significantly more memory than Line mode.	Remove the document. Press Start to print the job.
CONTROLLER FAULT - 50000002	The Controller has developed a "memory is full" internal fault. Large documents using Auto Reduction/Enlargement or Auto Rotate may cause this fault. Also, Photo and Mixed/Custom modes require significantly more memory than Line mode.	Remove the document. Wait for previous scans to finish printing. End the current set or print it if a set is in progress. Rescan the document.
CONTROLLER FAULT - 50000003 CONTROLLER FAULT - 50000004 CONTROLLER FAULT - 50000005	A task controlling the Scan System received an unrecognized request from the task controlling the Scan System control panel.	Power off the System. Check that all cables are connected correctly. Power on the System. See the "Powering off the System" and "Powering on the System" sections for more information.
CONTROLLER FAULT - 50000007	A software problem was encountered in controlling the Scan System.	Power off and power on the System. See the "Powering off the System" and "Powering on the System" sections for more information.
CONTROLLER FAULT - 50000008 - DOCUMENT JAM	A document jam has occurred in the Scan System.	Remove the jammed document. Scan the document again.
CONTROLLER FAULT - 50000011 - SCANNED IMAGE LOST	FreeFlow Accxes firmware supports a maximum of 128 active jobs in the printer queue. Scans made after the maximum were refused and a scan error was declared.	Allow the jobs in the queue to print, and then rescan the document. FreeFlow Accxes firmware reserves 8 jobs for Scan-to-Net and copy jobs. This provides sufficient capability for scans and copy jobs even when there is a high volume of print jobs on the network.
SCAN SYSTEM FAULT - 5000000B - CHECK SCAN SYSTEM VERIFY SCAN SYSTEM IS POWERED AND PROPERLY CONNECTED	A fault has occurred in communicating with the Scan System.	Check that the IEEE 1394 cable is properly connected at both ends. Check that the Scan System is still connected to the AC power and is still switched on. Power off and power on the System. See the "Powering off the System" and "Powering on the System" sections for more information.
SCAN SYSTEM FIRMWARE VERSION FAULT -50000020	Scan System firmware is not at current version to support Controller firmware version 11.0. Scan System firmware must be at version 3.2.6 or	Update the Scan System firmware.
152 • Problem solving		XEROX WIDE FORMAT COPY SYSTEM

Error message	Probable cause	Corrective action
40000001: ERROR ACCOUNTING DISK FULL	The Job Log File size has reached the maximum space allocated for it.	Contact your System Administrator.
40000002: ERROR	The number of Job Records in the Job Log File has reached the maximum as defined by the FreeFlow Accxes Account Management Tool.	Contact your System Administrator.
CONTROLLER FAULT - 50000001	The Controller has developed a "memory is full" internal fault. Large documents using Auto Reduction/Enlargement or Auto-Rotate may cause this fault. Also, Photo and Mixed/Custom modes require significantly more memory than Line mode.	Remove the document. Press Start to print the job.
CONTROLLER FAULT - 50000002	The Controller has developed a "memory is full" internal fault. Large documents using Auto Reduction/Enlargement or Auto Rotate may cause this fault. Also, Photo and Mixed/Custom modes require significantly more memory than Line mode.	Remove the document. Wait for previous scans to finish printing. End the current set or print it if a set is in progress. Rescan the document.
CONTROLLER FAULT - 50000003 CONTROLLER FAULT - 50000004 CONTROLLER FAULT - 50000005	A task controlling the Scan System received an unrecognized request from the task controlling the Scan System control panel.	Power off the System. Check that all cables are connected correctly. Power on the System. See the "Powering off the System" and "Powering on the System" sections for more information.
CONTROLLER FAULT - 50000007	A software problem was encountered in controlling the Scan System.	Power off and power on the System. See the "Powering off the System" and "Powering on the System" sections for more information.
CONTROLLER FAULT - 50000008 - DOCUMENT JAM	A document jam has occurred in the Scan System.	Remove the jammed document. Scan the document again.
CONTROLLER FAULT - 50000011 - SCANNED IMAGE LOST	FreeFlow Accxes firmware supports a maximum of 128 active jobs in the printer queue. Scans made after the maximum were refused and a scan error was declared.	Allow the jobs in the queue to print, and then rescan the document. FreeFlow Accxes firmware reserves 8 jobs for Scan-to-Net and copy jobs. This provides sufficient capability for scans and copy jobs even when there is a high volume of print jobs on the network.
SCAN SYSTEM FAULT - 5000000B - CHECK SCAN SYSTEM VERIFY SCAN SYSTEM IS POWERED AND PROPERLY CONNECTED	A fault has occurred in communicating with the Scan System.	Check that the IEEE 1394 cable is properly connected at both ends. Check that the Scan System is still connected to the AC power and is still switched on. Power off and power on the System. See the "Powering off the System" and "Powering on the System" sections for more information.
SCAN SYSTEM FAULT -	An error occurred during processing	Rescan the document.

Error message	Probable cause	Corrective action
40000001: ERROR ACCOUNTING DISK FULL	The Job Log File size has reached the maximum space allocated for it.	Contact your System Administrator.
40000002: ERROR	The number of Job Records in the Job Log File has reached the maximum as defined by the FreeFlow Accxes Account Management Tool.	Contact your System Administrator.
CONTROLLER FAULT - 50000001	The Controller has developed a "memory is full" internal fault. Large documents using Auto Reduction/Enlargement or Auto-Rotate may cause this fault. Also, Photo and Mixed/Custom modes require significantly more memory than Line mode.	Remove the document. Press Start to print the job.
CONTROLLER FAULT - 50000002	The Controller has developed a "memory is full" internal fault. Large documents using Auto Reduction/Enlargement or Auto Rotate may cause this fault. Also, Photo and Mixed/Custom modes require significantly more memory than Line mode.	Remove the document. Wait for previous scans to finish printing. End the current set or print it if a set is in progress. Rescan the document.
CONTROLLER FAULT - 50000003 CONTROLLER FAULT - 50000004 CONTROLLER FAULT - 50000005	A task controlling the Scan System received an unrecognized request from the task controlling the Scan System control panel.	Power off the System. Check that all cables are connected correctly. Power on the System. See the "Powering off the System" and "Powering on the System" sections for more information.
CONTROLLER FAULT - 50000007	A software problem was encountered in controlling the Scan System.	Power off and power on the System. See the "Powering off the System" and "Powering on the System" sections for more information.
CONTROLLER FAULT - 50000008 - DOCUMENT JAM	A document jam has occurred in the Scan System.	Remove the jammed document. Scan the document again.
CONTROLLER FAULT - 50000011 - SCANNED IMAGE LOST	FreeFlow Accxes firmware supports a maximum of 128 active jobs in the printer queue. Scans made after the maximum were refused and a scan error was declared.	Allow the jobs in the queue to print, and then rescan the document. FreeFlow Accxes firmware reserves 8 jobs for Scan-to-Net and copy jobs. This provides sufficient capability for scans and copy jobs even when there is a high volume of print jobs on the network.
SCAN SYSTEM FAULT - 5000000B - CHECK SCAN SYSTEM VERIFY SCAN SYSTEM IS POWERED AND PROPERLY CONNECTED	A fault has occurred in communicating with the Scan System.	Check that the IEEE 1394 cable is properly connected at both ends. Check that the Scan System is still connected to the AC power and is still switched on. Power off and power on the System. See the "Powering off the System" and "Powering on the System" sections for more information.
COMPLEX DOCUMENT	due to the complexity of the image	

Error message	Probable cause	Corrective action
40000001: ERROR ACCOUNTING DISK FULL	The Job Log File size has reached the maximum space allocated for it.	Contact your System Administrator.
40000002: ERROR	The number of Job Records in the Job Log File has reached the maximum as defined by the FreeFlow Accxes Account Management Tool.	Contact your System Administrator.
CONTROLLER FAULT - 50000001	The Controller has developed a "memory is full" internal fault. Large documents using Auto Reduction/Enlargement or Auto-Rotate may cause this fault. Also, Photo and Mixed/Custom modes require significantly more memory than Line mode.	Remove the document. Press Start to print the job.
CONTROLLER FAULT - 50000002	The Controller has developed a "memory is full" internal fault. Large documents using Auto Reduction/Enlargement or Auto Rotate may cause this fault. Also, Photo and Mixed/Custom modes require significantly more memory than Line mode.	Remove the document. Wait for previous scans to finish printing. End the current set or print it if a set is in progress. Rescan the document.
CONTROLLER FAULT - 50000003 CONTROLLER FAULT - 50000004 CONTROLLER FAULT - 50000005	A task controlling the Scan System received an unrecognized request from the task controlling the Scan System control panel.	Power off the System. Check that all cables are connected correctly. Power on the System. See the "Powering off the System" and "Powering on the System" sections for more information.
CONTROLLER FAULT - 50000007	A software problem was encountered in controlling the Scan System.	Power off and power on the System. See the "Powering off the System" and "Powering on the System" sections for more information.
CONTROLLER FAULT - 50000008 - DOCUMENT JAM	A document jam has occurred in the Scan System.	Remove the jammed document. Scan the document again.
CONTROLLER FAULT - 50000011 - SCANNED IMAGE LOST	FreeFlow Accxes firmware supports a maximum of 128 active jobs in the printer queue. Scans made after the maximum were refused and a scan error was declared.	Allow the jobs in the queue to print, and then rescan the document. FreeFlow Accxes firmware reserves 8 jobs for Scan-to-Net and copy jobs. This provides sufficient capability for scans and copy jobs even when there is a high volume of print jobs on the network.
SCAN SYSTEM FAULT - 5000000B - CHECK SCAN SYSTEM VERIFY SCAN SYSTEM IS POWERED AND PROPERLY CONNECTED	A fault has occurred in communicating with the Scan System.	Check that the IEEE 1394 cable is properly connected at both ends. Check that the Scan System is still connected to the AC power and is still switched on. Power off and power on the System. See the "Powering off the System" and "Powering on the System" sections for more information.
	that the document contains.	

Error message	Probable cause	Corrective action
40000001: ERROR ACCOUNTING DISK FULL	The Job Log File size has reached the maximum space allocated for it.	Contact your System Administrator.
40000002: ERROR	The number of Job Records in the Job Log File has reached the maximum as defined by the FreeFlow Accxes Account Management Tool.	Contact your System Administrator.
CONTROLLER FAULT - 50000001	The Controller has developed a "memory is full" internal fault. Large documents using Auto Reduction/Enlargement or Auto-Rotate may cause this fault. Also, Photo and Mixed/Custom modes require significantly more memory than Line mode.	Remove the document. Press Start to print the job.
CONTROLLER FAULT - 50000002	The Controller has developed a "memory is full" internal fault. Large documents using Auto Reduction/Enlargement or Auto Rotate may cause this fault. Also, Photo and Mixed/Custom modes require significantly more memory than Line mode.	Remove the document. Wait for previous scans to finish printing. End the current set or print it if a set is in progress. Rescan the document.
CONTROLLER FAULT - 50000003 CONTROLLER FAULT - 50000004 CONTROLLER FAULT - 50000005	A task controlling the Scan System received an unrecognized request from the task controlling the Scan System control panel.	Power off the System. Check that all cables are connected correctly. Power on the System. See the "Powering off the System" and "Powering on the System" sections for more information.
CONTROLLER FAULT - 50000007	A software problem was encountered in controlling the Scan System.	Power off and power on the System. See the "Powering off the System" and "Powering on the System" sections for more information.
CONTROLLER FAULT - 50000008 - DOCUMENT JAM	A document jam has occurred in the Scan System.	Remove the jammed document. Scan the document again.
CONTROLLER FAULT - 50000011 - SCANNED IMAGE LOST	FreeFlow Accxes firmware supports a maximum of 128 active jobs in the printer queue. Scans made after the maximum were refused and a scan error was declared.	Allow the jobs in the queue to print, and then rescan the document. FreeFlow Accxes firmware reserves 8 jobs for Scan-to-Net and copy jobs. This provides sufficient capability for scans and copy jobs even when there is a high volume of print jobs on the network.
SCAN SYSTEM FAULT - 5000000B - CHECK SCAN SYSTEM VERIFY SCAN SYSTEM IS POWERED AND PROPERLY CONNECTED	A fault has occurred in communicating with the Scan System.	Check that the IEEE 1394 cable is properly connected at both ends. Check that the Scan System is still connected to the AC power and is still switched on. Power off and power on the System. See the "Powering off the System" and "Powering on the System" sections for more information.
WARNING: xxxx	The image submitted for printing is	Recreate the image and try again.

Error message	Probable cause	Corrective action
40000001: ERROR ACCOUNTING DISK FULL	The Job Log File size has reached the maximum space allocated for it.	Contact your System Administrator.
40000002: ERROR	The number of Job Records in the Job Log File has reached the maximum as defined by the FreeFlow Accxes Account Management Tool.	Contact your System Administrator.
CONTROLLER FAULT - 50000001	The Controller has developed a "memory is full" internal fault. Large documents using Auto Reduction/Enlargement or Auto-Rotate may cause this fault. Also, Photo and Mixed/Custom modes require significantly more memory than Line mode.	Remove the document. Press Start to print the job.
CONTROLLER FAULT - 50000002	The Controller has developed a "memory is full" internal fault. Large documents using Auto Reduction/Enlargement or Auto Rotate may cause this fault. Also, Photo and Mixed/Custom modes require significantly more memory than Line mode.	Remove the document. Wait for previous scans to finish printing. End the current set or print it if a set is in progress. Rescan the document.
CONTROLLER FAULT - 50000003 CONTROLLER FAULT - 50000004 CONTROLLER FAULT - 50000005	A task controlling the Scan System received an unrecognized request from the task controlling the Scan System control panel.	Power off the System. Check that all cables are connected correctly. Power on the System. See the "Powering off the System" and "Powering on the System" sections for more information.
CONTROLLER FAULT - 50000007	A software problem was encountered in controlling the Scan System.	Power off and power on the System. See the "Powering off the System" and "Powering on the System" sections for more information.
CONTROLLER FAULT - 50000008 - DOCUMENT JAM	A document jam has occurred in the Scan System.	Remove the jammed document. Scan the document again.
CONTROLLER FAULT - 50000011 - SCANNED IMAGE LOST	FreeFlow Accxes firmware supports a maximum of 128 active jobs in the printer queue. Scans made after the maximum were refused and a scan error was declared.	Allow the jobs in the queue to print, and then rescan the document. FreeFlow Accxes firmware reserves 8 jobs for Scan-to-Net and copy jobs. This provides sufficient capability for scans and copy jobs even when there is a high volume of print jobs on the network.
SCAN SYSTEM FAULT - 5000000B - CHECK SCAN SYSTEM VERIFY SCAN SYSTEM IS POWERED AND PROPERLY CONNECTED	A fault has occurred in communicating with the Scan System.	Check that the IEEE 1394 cable is properly connected at both ends. Check that the Scan System is still connected to the AC power and is still switched on. Power off and power on the System. See the "Powering off the System" and "Powering on the System" sections for more information.
	corrupted or does not conform to the	

Error message	Probable cause	Corrective action
40000001: ERROR ACCOUNTING DISK FULL	The Job Log File size has reached the maximum space allocated for it.	Contact your System Administrator.
40000002: ERROR	The number of Job Records in the Job Log File has reached the maximum as defined by the FreeFlow Accxes Account Management Tool.	Contact your System Administrator.
CONTROLLER FAULT - 50000001	The Controller has developed a "memory is full" internal fault. Large documents using Auto Reduction/Enlargement or Auto-Rotate may cause this fault. Also, Photo and Mixed/Custom modes require significantly more memory than Line mode.	Remove the document. Press Start to print the job.
CONTROLLER FAULT - 50000002	The Controller has developed a "memory is full" internal fault. Large documents using Auto Reduction/Enlargement or Auto Rotate may cause this fault. Also, Photo and Mixed/Custom modes require significantly more memory than Line mode.	Remove the document. Wait for previous scans to finish printing. End the current set or print it if a set is in progress. Rescan the document.
CONTROLLER FAULT - 50000003 CONTROLLER FAULT - 50000004 CONTROLLER FAULT - 50000005	A task controlling the Scan System received an unrecognized request from the task controlling the Scan System control panel.	Power off the System. Check that all cables are connected correctly. Power on the System. See the "Powering off the System" and "Powering on the System" sections for more information.
CONTROLLER FAULT - 50000007	A software problem was encountered in controlling the Scan System.	Power off and power on the System. See the "Powering off the System" and "Powering on the System" sections for more information.
CONTROLLER FAULT - 50000008 - DOCUMENT JAM	A document jam has occurred in the Scan System.	Remove the jammed document. Scan the document again.
CONTROLLER FAULT - 50000011 - SCANNED IMAGE LOST	FreeFlow Accxes firmware supports a maximum of 128 active jobs in the printer queue. Scans made after the maximum were refused and a scan error was declared.	Allow the jobs in the queue to print, and then rescan the document. FreeFlow Accxes firmware reserves 8 jobs for Scan-to-Net and copy jobs. This provides sufficient capability for scans and copy jobs even when there is a high volume of print jobs on the network.
SCAN SYSTEM FAULT - 5000000B - CHECK SCAN SYSTEM VERIFY SCAN SYSTEM IS POWERED AND PROPERLY CONNECTED	A fault has occurred in communicating with the Scan System.	Check that the IEEE 1394 cable is properly connected at both ends. Check that the Scan System is still connected to the AC power and is still switched on. Power off and power on the System. See the "Powering off the System" and "Powering on the System" sections for more information.
	standards for the format.	

Error message	Probable cause	Corrective action
40000001: ERROR ACCOUNTING DISK FULL	The Job Log File size has reached the maximum space allocated for it.	Contact your System Administrator.
40000002: ERROR	The number of Job Records in the Job Log File has reached the maximum as defined by the FreeFlow Accxes Account Management Tool.	Contact your System Administrator.
CONTROLLER FAULT - 50000001	The Controller has developed a "memory is full" internal fault. Large documents using Auto Reduction/Enlargement or Auto-Rotate may cause this fault. Also, Photo and Mixed/Custom modes require significantly more memory than Line mode.	Remove the document. Press Start to print the job.
CONTROLLER FAULT - 50000002	The Controller has developed a "memory is full" internal fault. Large documents using Auto Reduction/Enlargement or Auto Rotate may cause this fault. Also, Photo and Mixed/Custom modes require significantly more memory than Line mode.	Remove the document. Wait for previous scans to finish printing. End the current set or print it if a set is in progress. Rescan the document.
CONTROLLER FAULT - 50000003 CONTROLLER FAULT - 50000004 CONTROLLER FAULT - 50000005	A task controlling the Scan System received an unrecognized request from the task controlling the Scan System control panel.	Power off the System. Check that all cables are connected correctly. Power on the System. See the "Powering off the System" and "Powering on the System" sections for more information.
CONTROLLER FAULT - 50000007	A software problem was encountered in controlling the Scan System.	Power off and power on the System. See the "Powering off the System" and "Powering on the System" sections for more information.
CONTROLLER FAULT - 50000008 - DOCUMENT JAM	A document jam has occurred in the Scan System.	Remove the jammed document. Scan the document again.
CONTROLLER FAULT - 50000011 - SCANNED IMAGE LOST	FreeFlow Accxes firmware supports a maximum of 128 active jobs in the printer queue. Scans made after the maximum were refused and a scan error was declared.	Allow the jobs in the queue to print, and then rescan the document. FreeFlow Accxes firmware reserves 8 jobs for Scan-to-Net and copy jobs. This provides sufficient capability for scans and copy jobs even when there is a high volume of print jobs on the network.
SCAN SYSTEM FAULT - 5000000B - CHECK SCAN SYSTEM VERIFY SCAN SYSTEM IS POWERED AND PROPERLY CONNECTED	A fault has occurred in communicating with the Scan System.	Check that the IEEE 1394 cable is properly connected at both ends. Check that the Scan System is still connected to the AC power and is still switched on. Power off and power on the System. See the "Powering off the System" and "Powering on the System" sections for more information.
LL codes appear	Intermittent Scan System and/or	Power the system off then on. If the

Error message	Probable cause	Corrective action
40000001: ERROR ACCOUNTING DISK FULL	The Job Log File size has reached the maximum space allocated for it.	Contact your System Administrator.
40000002: ERROR	The number of Job Records in the Job Log File has reached the maximum as defined by the FreeFlow Accxes Account Management Tool.	Contact your System Administrator.
CONTROLLER FAULT - 50000001	The Controller has developed a "memory is full" internal fault. Large documents using Auto Reduction/Enlargement or Auto-Rotate may cause this fault. Also, Photo and Mixed/Custom modes require significantly more memory than Line mode.	Remove the document. Press Start to print the job.
CONTROLLER FAULT - 50000002	The Controller has developed a "memory is full" internal fault. Large documents using Auto Reduction/Enlargement or Auto Rotate may cause this fault. Also, Photo and Mixed/Custom modes require significantly more memory than Line mode.	Remove the document. Wait for previous scans to finish printing. End the current set or print it if a set is in progress. Rescan the document.
CONTROLLER FAULT - 50000003 CONTROLLER FAULT - 50000004 CONTROLLER FAULT - 50000005	A task controlling the Scan System received an unrecognized request from the task controlling the Scan System control panel.	Power off the System. Check that all cables are connected correctly. Power on the System. See the "Powering off the System" and "Powering on the System" sections for more information.
CONTROLLER FAULT - 50000007	A software problem was encountered in controlling the Scan System.	Power off and power on the System. See the "Powering off the System" and "Powering on the System" sections for more information.
CONTROLLER FAULT - 50000008 - DOCUMENT JAM	A document jam has occurred in the Scan System.	Remove the jammed document. Scan the document again.
CONTROLLER FAULT - 50000011 - SCANNED IMAGE LOST	FreeFlow Accxes firmware supports a maximum of 128 active jobs in the printer queue. Scans made after the maximum were refused and a scan error was declared.	Allow the jobs in the queue to print, and then rescan the document. FreeFlow Accxes firmware reserves 8 jobs for Scan-to-Net and copy jobs. This provides sufficient capability for scans and copy jobs even when there is a high volume of print jobs on the network.
SCAN SYSTEM FAULT - 5000000B - CHECK SCAN SYSTEM VERIFY SCAN SYSTEM IS POWERED AND PROPERLY CONNECTED	A fault has occurred in communicating with the Scan System.	Check that the IEEE 1394 cable is properly connected at both ends. Check that the Scan System is still connected to the AC power and is still switched on. Power off and power on the System. See the "Powering off the System" and "Powering on the System" sections for more information.
intermittently while	software problems.	problem persists, call for service.

Error message	Probable cause	Corrective action
40000001: ERROR ACCOUNTING DISK FULL	The Job Log File size has reached the maximum space allocated for it.	Contact your System Administrator.
40000002: ERROR	The number of Job Records in the Job Log File has reached the maximum as defined by the FreeFlow Accxes Account Management Tool.	Contact your System Administrator.
CONTROLLER FAULT - 50000001	The Controller has developed a "memory is full" internal fault. Large documents using Auto Reduction/Enlargement or Auto-Rotate may cause this fault. Also, Photo and Mixed/Custom modes require significantly more memory than Line mode.	Remove the document. Press Start to print the job.
CONTROLLER FAULT - 50000002	The Controller has developed a "memory is full" internal fault. Large documents using Auto Reduction/Enlargement or Auto Rotate may cause this fault. Also, Photo and Mixed/Custom modes require significantly more memory than Line mode.	Remove the document. Wait for previous scans to finish printing. End the current set or print it if a set is in progress. Rescan the document.
CONTROLLER FAULT - 50000003 CONTROLLER FAULT - 50000004 CONTROLLER FAULT - 50000005	A task controlling the Scan System received an unrecognized request from the task controlling the Scan System control panel.	Power off the System. Check that all cables are connected correctly. Power on the System. See the "Powering off the System" and "Powering on the System" sections for more information.
CONTROLLER FAULT - 50000007	A software problem was encountered in controlling the Scan System.	Power off and power on the System. See the "Powering off the System" and "Powering on the System" sections for more information.
CONTROLLER FAULT - 50000008 - DOCUMENT JAM	A document jam has occurred in the Scan System.	Remove the jammed document. Scan the document again.
CONTROLLER FAULT - 50000011 - SCANNED IMAGE LOST	FreeFlow Accxes firmware supports a maximum of 128 active jobs in the printer queue. Scans made after the maximum were refused and a scan error was declared.	Allow the jobs in the queue to print, and then rescan the document. FreeFlow Accxes firmware reserves 8 jobs for Scan-to-Net and copy jobs. This provides sufficient capability for scans and copy jobs even when there is a high volume of print jobs on the network.
SCAN SYSTEM FAULT - 5000000B - CHECK SCAN SYSTEM VERIFY SCAN SYSTEM IS POWERED AND PROPERLY CONNECTED	A fault has occurred in communicating with the Scan System.	Check that the IEEE 1394 cable is properly connected at both ends. Check that the Scan System is still connected to the AC power and is still switched on. Power off and power on the System. See the "Powering off the System" and "Powering on the System" sections for more information.
documents are scanned		

Specifications

Specifications

Speed	8825	8830	8850	510 Series	721P	6030/6050	6204
2 inches per second	standard						
4 inches per second	optional	standard	standard	standard	standard	standard	standard
1 inch per second color	optional	optional	optional	optional	optional	optional	optional
7.33 inches per second*					standard		

* Requires Turbo III Speed Enhancement feature key, HFT, PUN, YKE, or YKE-N Controller running version 9.0 or higher software, WIDE FORMAT SCAN SYSTEM firmware version 3.0.7A or higher.

Input Document

Maximum document:	42" x 100 feet (1.07m x 30.5 m)
Maximum Scan Width:	36" (914 mm)
Minimum document:	A size 8.5 x 11 (216mm x 279mm) A4 size (210mm x 297mm)
Document Thickness:	0.0023 to 0.50 " (0,06mm to 13mm)
Thick Document Weight:	6 lbs (2.72 kg) max.

Scan System Resolution

Copying:	200, 300, 400 dots per inch
Scan-to-Net	75, 100, 200, 300, 400 dots per inch

Magnification:	25% to 400% in $\pm 0.1\%$ increments
-----------------------	---------------------------------------

Temperature

Minimum:	55 F (10 C)
Maximum:	90 F(32 C)

Humidity: 20% - 80%

Maximum Elevation: 0 - 6560 feet

0 - 1.995 km

Heat Emission

Running: 690 BTU/hr

Power Consumption

Standby: 130 W

Running: 200 W

Electrical Requirements

Voltage (AC): 100 - 120 VAC

200 - 240 VAC

Current: 4 amps

3 amps

Frequency: 50/60 Hz

Audible Noise

Standby: 33.7 dBA

Running: 52.1 dBA

Impulse: 56.4 dBA

Appendices

Appendix 1: Scanning Resolutions and Speeds

Table 9 below shows the minimum and maximum scanning speeds for a 36 inch (914 mm) wide document in Line, Mixed, and Photo modes at various resolutions.

NOTE: Speeds are given in inches per second (IPS) and centimeters per second (cm/s).

NOTE: Thick documents are scanned at a maximum speed of 4.00 IPS/10.16cm/s in all Modes.

Table 9. Scanning resolutions and speeds

Mode	DPI	Pixel Depth	Turbo II		Turbo III		2 IPS	
			Min IPS/ cm/s	Max IPS/ cm/s	Min IPS/ cm/s	Max IPS/ cm/s	Min IPS/ cm/s	Max IPS/ cm/s
Line (copy or scan mode)	400	1 bit	4.00/10.16	4.00/10.16	7.00/17.78	7.00/17.78	2.00/5.08	4.00/10.16
Line (scan mode)	300	1 bit	4.00/10.16	4.00/10.16	4.00/10.16	4.00/10.16	2.00/5.08	4.00/10.16
Line (scan mode)	200	1 bit	8.00/20.32	8.00/20.32	8.00/20.32	8.00/20.32	4.00/10.16	4.00/10.16
Line (scan mode)	100	1 bit	8.00/20.32	8.00/20.32	8.00/20.32	8.00/20.32	4.00/10.16	4.00/10.16
Normal and Photo only (scan mode)	75	4 bit	2.00/5.08	4.00/10.16			2.00/5.08	4.00/10.16
Photo (scan mode)	400	8 bit	0.5/1.27	4.00/10.16	4.00/10.16	4.00/10.16	0.5/1.27	4.00/10.16
Photo (scan mode)	300	8 bit	1.00/2.54	4.00/10.16	4.00/10.16	4.00/10.16	1.00/2.54	4.00/10.16
Photo (copy or scan mode)	200	8 bit	2.00/5.08	8.00/20.32	8.00/20.32	8.00/20.32	2.00/5.08	4.00/10.16
Photo (scan mode)	100	8 bit	8.00/20.32	8.00/20.32	8.00/20.32	8.00/20.32	4.00/10.16	4.00/10.16

Appendix 2: Paper Sheet Sizes

Paper sizes supported by the 8825, 8830, 8850, 510 Series, 721P, 6030/6050, and 6204 Printers and the Controller with Firmware 9.1 or higher are shown in Table 10.

The Media types supported by your printer and the FreeFlow Accxes firmware can be checked on the Web Print Management Tool by selecting Defaults > Media > Media Defaults > Media Type. Available roll sizes for each supported media type can be quickly and easily checked from the supplies page of the XEROX website at www.xerox.com.

Table 10. Printer paper sizes

Paper size	Dimension	8825/8830/8850 /510dp Series	721P	6030/6050	6204
ISO A0	841 x 1189 mm	X	X	X	X
ISO A1	594 x 841 mm	X	X	X	X
ISO A2	420 x 594 mm	X	X	X	X
ISO A3	297 x 420 mm	X	X	X	X
ISO A4	210 x 297 mm	X	X	X	X
ISO B1	707 x 1000 mm	X	X	X	X
ISO B2	500 x 707 mm	X	X	X	X
ISO B3	353 x 500 mm	X	X	X	X
ISO B4	250 x 353 mm	X	X	X	X
ANSI A	8.5 x 11 (215.9 x 279.4 mm)	X	X	X	X
ANSI B	11 x 17 in. (279.4 x 431.8 mm)	X	X	X	X
ANSI C	17 x 22 in. (431.8 x 558.8 mm)	X	X	X	X
ANSI D	22 x 34 in. (558.8 x 863.6 mm)	X	X	X	X
ANSI E	34 x 44 in. (863.6 x 1117.6 mm)	X	X	X	X
Architectural A	9 x 12 in. (228.6 x 304.8 mm)	X	X	X	X
Architectural B	12 x 18 in. (304.8 x 457.2 mm)	X	X	X	X
Architectural C	18 x 24 in. (457.2 x 609.6 mm)	X	X	X	X
Architectural D	24 x 36 in. (609.6 x 914.4 mm)	X	X	X	X
Architectural E	36 x 48 in. (914.4 x 1219.2 mm)	X	X	X	X
Architectural 30"	30 x 42 in. (76.2 x 1066.8 mm)	X	X	X	X
JIS B4	257mm		X	X	X

JIS B3	364mm		X	X	X
JIS B2	515mm		X	X	X
JIS B1	728mm		X	X	X

Appendix 3: Paper Roll Sizes

Table 11 below shows roll sizes supported by the 8825, 8830, 8850, 510 Series, 721P, 6030/6050, and 6204 Printers.

Table 11. Printer roll sizes

Roll size	Width	8825/8830/8850 /510dp Series	721P	6030/6050	6204
ISO Roll A0	841 mm	X	X	X	X
ISO Roll A1	594 mm	X	X	X	X
ISO Roll A2	420 mm	X	X	X	X
ISO Roll A3	297 mm	X	X	X	X
Roll 891	891 mm	-	X	-	-
Roll 900	900 mm	X	X	X	-
ANSI Roll 11	11 in.	X	X	X	X
ANSI Roll 17	17 in.	X	X	X	X
ANSI Roll 22	22 in.	X	X	X	X
ANSI Roll 34	34 in.	X	X	X	X
ARCH Roll 12	12 in.	X	X	X	X
ARCH Roll 18	18 in.	X	X	X	X
ARCH Roll 24	24 in.	X	X	X	X
ARCH Roll 30	30 in.	X	X	X	X
ISO B3	353 mm	X	X	X	X
ISO B2	500 mm	X	X	X	X
ISO B1	707 mm	X	X	X	X
JIS B3	364 mm		X		X
JIS B2	515 mm		X		X
JIS B1	728 mm		X		X
Sp. A2	440 mm				X
Sp. A1	620 mm	X	-	X	X
	750 mm	X	-	X	
	860 mm	X	-	X	X
Sp. A0	880 mm	X	X	X	X

Appendix 4: File Formats

File formats supported by the Controller with Firmware 12.0 are shown in the list below.

Standard:

- C4
- CalComp
- CALS (Type-1 and Type-2)
- CGM (Version 2)
- DDS
- Filenet
- HP-GL (in conformity with HP75XX series)
- HP-GL/2/RTL (in conformity with HP Design Jet 750C)
- JPEG (JFIF Version 1.02)
- NIRS
- TIFF (Version 6.0)
- VCGL
- VDS (VRF, Block Raster, Compressed Raster, VOF)
- Versatec Raster/Green Sheet

Optional (require enablement by Feature Key)

- Post Script 3, PDF 1.6 for YKE-N controller, PDF 1.4 and 1.5 for YKE controller; PDF 1.3 for all other controllers.
- AutoCAD/AEC – DWF

Appendix 6: LED Status Indicators

The PUN Controller has four LED status indicators as shown in Table 12 below.

Table 12. Controller LED status indicators

LED Number	Color	Indicated Condition
LED 1	Green	"Ready." Indicates that the Controller is powered up and ready to process incoming jobs.
LED 2	Green	"Busy." Indicates that the Controller is busy processing a job.
LED 3	Yellow	"Mismatch." Indicates that a media mismatch, which may be blocking the print queue, has occurred. This also displays when the Controller's Accounting disk is full, or when the Controller has reached its Accounting record limit. Check the Web Print Management Tool's Main Page to determine the problem.
LED 4	Red	"Attention." Indicates that a Printer or Finisher fault has occurred. May indicate a paper jam, out of toner condition, out of media condition, or a communications problem with one of the devices.

During power-on self test (POST), the firmware will light LEDs 2, 3, and 4. After POST has successfully completed, LEDs 2, 3, and 4 will be switched OFF, and LED 1 will be switched ON. If POST did not successfully complete, all 4 LEDs will be switched OFF (i.e., they will be unlit).

Appendix 7: Main Menu Structure

Appendix 7 shows the Main Menu structure. The menu tree below shows the top level of the Main Menu. The pages that follow contain menu trees for each of the four top-level options.

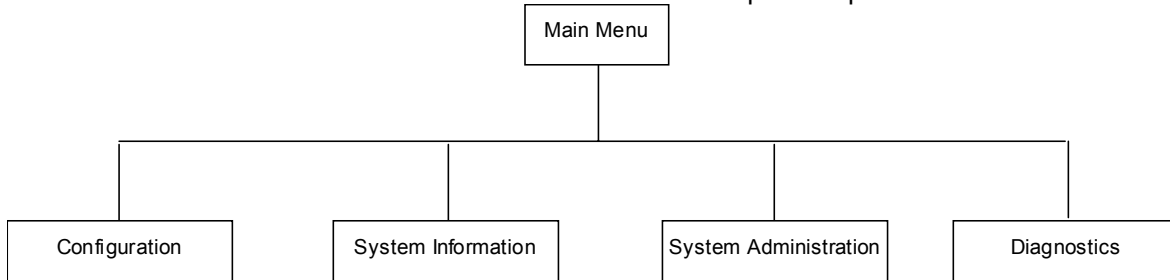

The menu tree below shows the Configuration option structure of the Main Menu.

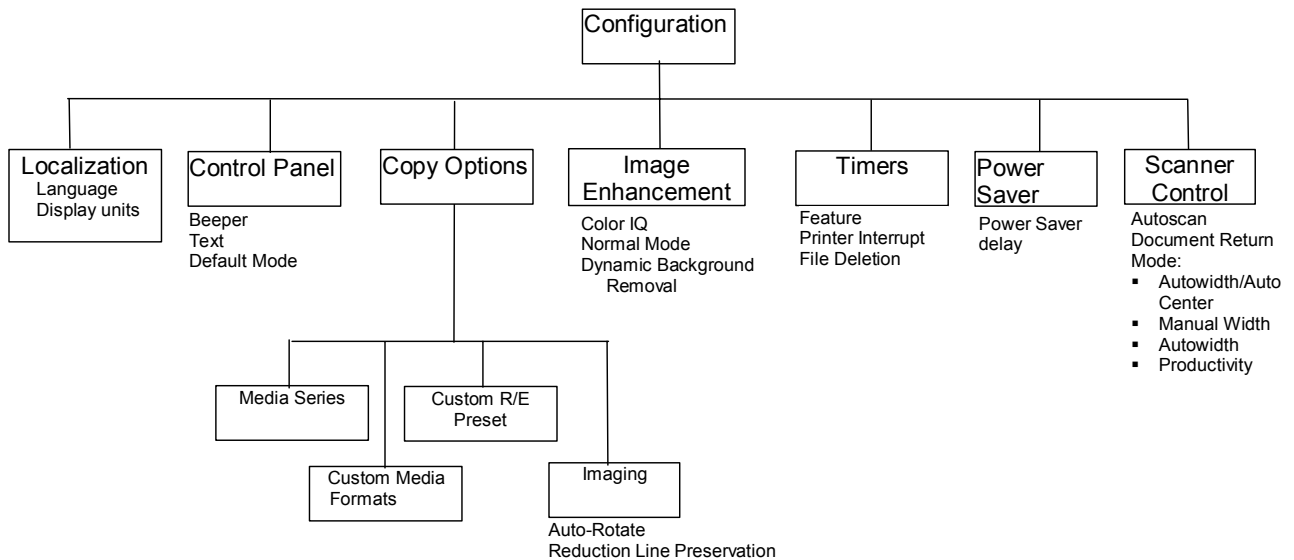

The menu tree below shows the System Information option structure of the Main Menu.

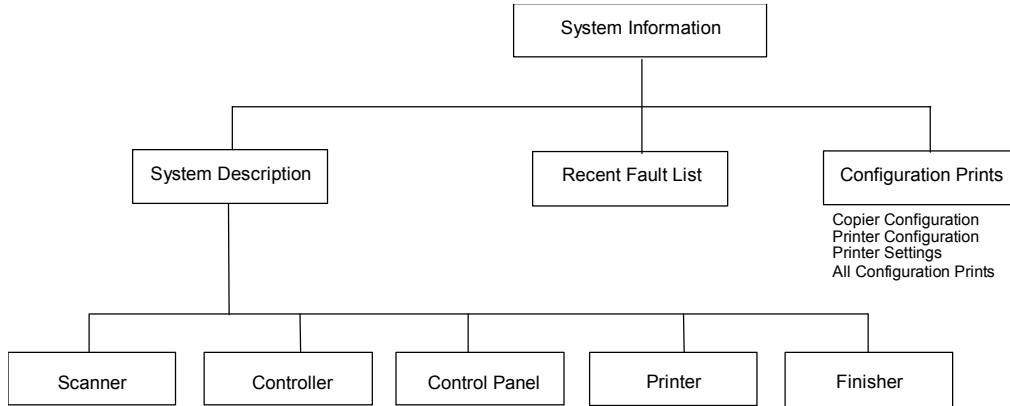

The menu tree below shows the structure of the System Administration option of the Main Menu.

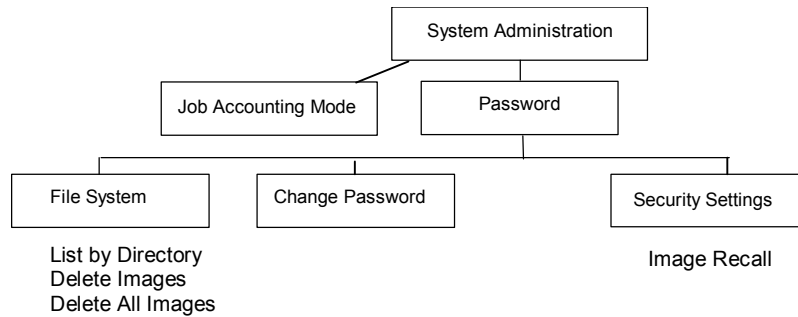

The menu tree below shows the Diagnostics option structure of the Main Menu.

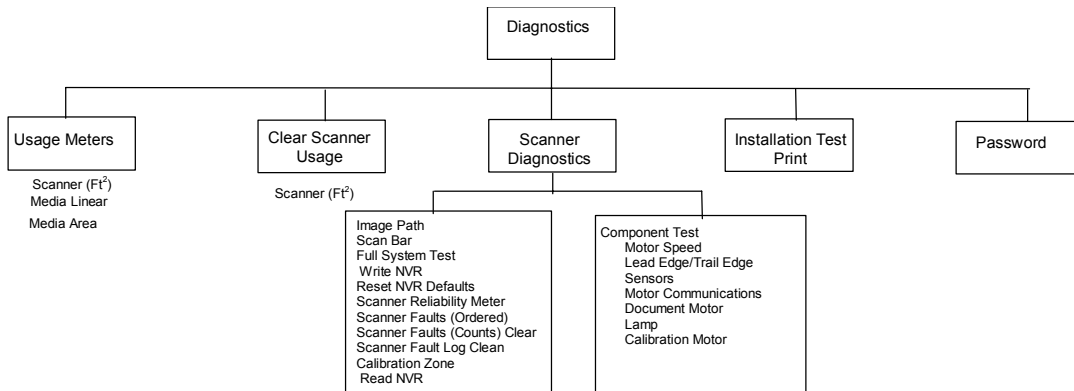

Index

- ADAPTIVE CONTRAST, 103
- Auto**, 17
- Auto Media Source, 18
- AUTO ROTATE, 101
- Automatic edge detection and document centering, 34
- AUTOSCAN, 49, 105, 106
- AUTOWIDTH, 50, 105
- AUTOWIDTH /AUTCENTER, 34
- AUTOWIDTH/AUTCENTER, 50, 106
- Background Suppression**, 47, 88
- Background Suppression option, 16
- Batch key, 75
- beeper, 96
- BEST COMPRESSION, 46
- BEST IQ, 46
- blueprint, 37
- C/CA** (Clear/Clear All) key, 22
- C/CA** key, 90
- CAD_GIS, 46
- CALIBRATION MOTOR, 129
- CALIBRATION MOTOR option, 135
- Calibration Roll Drive Gear, 133
- Calibration Screen, 135
- CHANGE PASSWORD, 112
- CHANGE PASSWORD option, 117
- Change Password Screen, 117
- checkplot, 73
- CLEAN CAL ZONE, 128
- Clean Cal Zone Screen, 128
- CLEAN CALIBRATION ZONE, 122
- Cleaning and maintenance - Scanner, 143
- Cleaning the Calibration Strip, 145
- Cleaning the Platen Glass and Document Drive Rolls, 144
- CLEAR LAST IMAGE, 90
- Clear Scanned Image Screen, 90
- CLEAR SCANNER FAULT LOG, 121
- CLEAR SCANNER FAULT LOG option, 128
- Clear Scanner Fault Log Screen, 128
- CLEAR SCANNER USAGE, 119
- Clear Scanner Usage Screen, 121
- Clearing the scanned images, 90
- Color**, 15, 44
- Color Enablement Feature Key**, 2
- Color lithograph, 37
- Color map, 37
- Color photograph, 37
- Compact Organizer, 7
- Compact Stacker, 7
- COMPONENT TESTS, 122
- COMPONENT TESTS option, 128
- Component Tests Screen, 129
- COMPRESSION (JPEG selected), 46
- COMPRESSION (TIFF selected), 45
- CONFIGURATION, 93
- Configuration menu, 94
- Configuration menu options, 171
- CONFIGURATION menu:, 94

CONFIGURATION PRINTS, 107
 CONFIGURATION PRINTS option, 110
 Configuration Screen, 95, 110
 CONTROL PANEL, 94
 CONTROL PANEL option, 96
 Control Panel Screen, 96
 CONTROLLER FAULT, 150
 Controller Power Switches, 26
 Controller Screen, 108
 Copier Configuration Screen, 111
 Copier Parameters and Images Screen, 62
 copies, making, 49
 COPY LENGTH, 41, 101
 COPY mode, 85
 COPY MODE, 40
 Copy Mode Sample, 82
Copy option, 17, 48
 COPY OPTIONS, 94, 97
 COPY OPTIONS menu, 97
 Copy Options Screen, 97
 copy the same size as the original document, 53
 CROSSFOLD OPTIONS, 71
 CUSTOM MEDIA FORMATS, 99
 Custom Media Formats Screen, 100, 107
 Custom Output Format Screen, 11
 CUSTOM R/E PRESETS option, 100
 Custom R/E Presets Screen, 101
 Decimal key, 22
 DEFAULT, 45
 Default media settings, 52
 DELETE ALL IMAGES, 113
 DELETE ALL IMAGES option, 116
 Delete All Images Screen, 116
 DELETE IMAGE option, 115
 DELETE IMAGES, 113
 Delete Images Screen, 115
 Delete Last Job Screen, 63
 DELETE TEMPLATE option, 66
 Delete Template Screen, 67
 Deleting the Last Job, 63
 DIAGNOSTICS, 93
 Diagnostics menu, 119
 Diagnostics Menu, 120
 Diagnostics Menu options, 172
 DIAGNOSTICS option, 119
 display units, 95
 Document Exit Slot, 6
 Document Feed Tray, 5
 Document Handler, 4
 DOCUMENT MOTOR, 129
 Document Motor
 Communications Screen, 133
 Document Motor Screen, 134
 Document quality, 33
 DOCUMENT RETURN, 49, 105
 DYNAMIC BACKGROUND REMOVAL, 41
 DYNAMIC BACKGROUND REMOVAL, 33
 Enlargement, 100
Enter key, 21
Error Code Table, 150
 Error Screen - Job Accounting, 142
Exit key, 21
 Faded line/text drawing, 37
 FASTEST, 41
 Feature Keys, 2
 FILE DELETION, 104
 FILE FORMAT, 43
 File formats supported, 169
 file system, 90
 FILE SYSTEM, 112
 FILE SYSTEM option, 90, 113
 File System Screen, 114
 film, vellum/tracing, 37
Finisher key, 56, 68
 Finisher Not Available Error Message Screen, 69
 Finisher Screen, 68, 109
 fixed copy size, 54
 FOLD PROGRAM, 70
 Fold Program Screen, 70
 Folder, 55
 FORMAT, 42, 45
 FORWARD prints, 74
 FTP, 1, 21, 83, 85, 118
 FTP Transfer Failed Screen, 86
 FULL SYSTEM TEST, 121
 FULL SYSTEM TEST option, 124
 Full System Test Screen, 124
 Graphical Display, 8
 HFT Controller, 26
 IEEE 1394 Cable and Connector, 6
 IMAGE ENHANCEMENT feature, 102
 Image Enhancement Screen, 17, 41, 103

IMAGE ENHANCEMENTS, 94
 Image Entering the Scanner
 Diagram, 77
 IMAGE PATH, 121
 Image Path Screen, 123
Image Quality, 13, 39, 51
 Image Quality Area, 13
 Image Quality Illustration, 51
 IMAGING option, 101
 Imaging screen, 41
 Imaging Screen, 102
 Immediate Image Overwrite, 61
 INDEX, 45
 INDEX ED, 45
 INSTALLATION TEST PRINT,
 119
 INTELLIGENT TITLE BLOCK,
 72
 Invalid Mode screen, 14
 INVERT option, 80
 Job Accounting, 139
 JOB ACCOUNTING MODE,
 112, 140
 Job Accounting Mode Screen,
 140
 JOB ACCOUNTING option, 113
 Job Parameters and Images
 Screen, 63
 Job Parameters Recalled
 Screen, 66, 68
 Job Parameters Saved Option,
 67
 Job Parameters Saved Screen,
 65
 JOB TEMPLATES, 61
 JOB TEMPLATES option, 63
 Job Templates Screen, 64
 JUSTIFICATION, 76
 JUSTIFICATION option, 78
 Justification Screen, 79
 LAMP, 129
 language, 95
 LAST JOB, 61
 LAST JOB option, 61
 Last Job Screen, 62
 LEAD EDGE/TRAIL EDGE, 129
 Lead Edge/Trail Edge
 Adjustment Screen, 130
 LEAD EDGE/TRAIL EDGE
 option, 130
LED status indicators, 170
 LED Status Indicators, 170
Line, 15, 42
Line mode, 40
 Line, photo or mixed original on
 film, 37
 LIST BY DIRECTORY, 113
 List by Directory Screen, 114
 LOCALIZATION, 94
 LOCALIZATION option, 95
 Localization Screen, 95
 long document, 57
 Main Menu, 93
 Main menu options, 171
 Main Menu Screen, 94
 MANUAL, 50
Manual mode, 11
Manual mode, 18
 Manual Reduction/Enlargement
 Screen, 19
 MANUAL WIDTH, 105
 MARGIN OPTIONS, 71
 Margin Options Screen, 71
 MARGINS, 76
 margins for an image, 77
 MARGINS option, 76
 Margins Selection Screen in
 Transform Menu, 77, 78
 MAXIMUMCOPY LENGTH, 41,
 101
 MEDIA FORMATS, 99
 Media Selection, 9
Media Selection Area, 9
 MEDIA SERIES option, 98
 Media Series Screen, 99
Media sizes, 98
Menu key, 20
 MIRROR option, 79
Mirror transformations, 80
Mode key, 21
 MOTOR COMMUNICATIONS,
 129
 MOTOR COMMUNICATIONS
 test, 133
 MOTOR SPEED, 129
 MOTOR SPEED option, 130
 Motor Speed Screen, 130
 Navigation keys, 8
 Navigational Keys and
 Graphical Display Area, 20
Next key, 21
Normal, 14
 NORMAL, 46
Normal mode, 40, 42
 NORMAL MODE, 41
 Numeric Keypad, 22
 Numerical Key pad, 8
 Operating in SCAN mode, 88
 Option Keys section, 8
Original, Type, 14, 39
 OUTPUT BIN option, 72
 Output Bin Screen, 73

Output Format option, 11
 OVERLENGTH OPTIONS, 70
 Overlength Options Screen, 70
 oversized documents, 57
 PACKBITS, 44, 45
 PALETTE, 45
paper sizes, 166
 password, 112
 PASSWORD, 119
 PASSWORD option, 136
 Password Screen, 137
 PERCEPTUAL, 46
Photo, 15, 43
Photo mode, 40
 Please Enter Account Id
 Screen, 141
 Please Enter Directory Screen,
 87
 Please Enter User Id Screen,
 141
 Power Cord, 6
 Power off the Controller and the
 Printer, 31
 power on the XEROX WIDE
 FORMAT COPY
 SYSTEMS, 24
 Power On/Off Switch, 6, 24
 Power On/Off Switch Photo, 32
 POWER SAVER, 94
 POWER SAVER option, 105
 Power Saver Screen, 105
 Power Switch Photo, 25
 Preparing documents, 36
Preset, 11
Preset (factory default), 19
 Preset Output Format screen,
 12
 Preset Output Format Screen,
 54
 Preset Reduction/Enlargement
 Screen, 19
 PREVIEW, 43
 PREVIEW, 42, 45
 Printer Configuration Screen,
 111
 PRINTER INTERRUPT, 104
 Printer Interrupt key, 60
 Printer Screen, 109
 Printer Settings Screen, 111
 Problem solving, 147
 PRODUCTIVITY, 106
 PRODUCTIVITY – ANSI, 50
 PRODUCTIVITY MODE, 34
 PUNCH OPTIONS, 71
 Punch Options Screen, 71
 READ NVR, 122
 READ NVR option, 136
 Read NVR Screen, 136
 Ready to Build Set Screen, 74
 Ready to Copy Screen, 21, 31,
 40, 52, 56, 70, 93
 Ready to Print Set Screen, 74
 Ready to Scan Screen, 21, 87
 READY TO SCAN screen, 87
 RECALL FACTORY
 DEFAULTS, 61, 68
 RECALL LAST JOB, 61, 62
 RECALL TEMPLATE option, 65
 Recall Template Screen, 66
 RECENT FAULT LIST, 107
 RECENT FAULT LIST option,
 109
 Recent Fault List Screen, 110
Reduce/Enlarge, 18, 88
 Reduce/Enlarge Area, 18
 Reduction, 100
 REDUCTION LINE
 PRESERVATION, 41
 REDUCTION LINE
 PRESERVATION, 101
 RESET NVR DEFAULTS, 121
 RESET NVR DEFAULTS
 option, 125
 Reset NVR Defaults Screen,
 125
 REVERSE prints, 74
roll sizes, 168
 Safety Notes, vii
 Sample key, 82
 Sample Mode Screen, 82
 SAVE DEFAULT TEMPLATE,
 61
 SAVE DEFAULT TEMPLATE
 option, 67
 SAVE TEMPLATE option, 64
 Save Template Screen, 64
 SCAN BAR, 121
 SCAN BAR option, 123
 Scan Bar Screen, 123
 Scan Control keys, 8
 Scan Control Keys, 23
 SCAN mode, 85
 SCAN MODE, 41
 Scan Mode Sample, 82
 Scan Options (Color) Screen,
 46
 Scan Options (Color) screens,
 16
 Scan Options (Color) Screens,
 45
 Scan Options (Line) Screen, 15,
 43

Scan Options (Normal) Screen, 14, 42
 Scan Options (Photo) Screen, 15, 43, 44
 Scanner compact components, 7
 SCANNER CONTROL, 94
 SCANNER CONTROL option, 105
 Scanner Control Panel, 4, 8
 Scanner Control Panel Photo, 8
 Scanner Control Screen, 49, 106
 SCANNER DIAGNOSTICS, 119
 SCANNER DIAGNOSTICS option, 121
 Scanner Diagnostics Screen, 122
 SCANNER FAULTS (COUNT) option, 127
 SCANNER FAULTS (COUNTS), 121
 Scanner Faults (Counts) Screen, 128
 SCANNER FAULTS (ORDERED), 121
 SCANNER FAULTS (ORDERED) option, 126
 Scanner Faults (Ordered) Screen, 127
 SCANNER RELIABILITY METER, 121
 SCANNER RELIABILITY METER option, 125
 Scanner Reliability Screen, 126
 Scanner Screen, 108
 Scanner standard components, 3
 Scanning Resolutions, 165
Scanning resolutions and speeds, 165
 Scanning strategies, 37
Scanning strategies for special documents, 37
 Scanning to the Network, 85
Scan-to-FTP, 85
 Scan-to-Net, 86
Scan-to-Net Feature Key, 2
Scan-to-Print Feature Key, 2
 security feature, 85
 SECURITY SETTINGS, 118
 SECURITY SETTINGS, 112
 SECURITY SETTINGS option, 118
 Security Settings Screen, 119
 Selections disabled in SCAN mode, 88
 SENSORS, 129
 SENSORS option, 131
 Sensors Screen, 131
 sepia, 37
Sets Build, 88
 Sets Build key, 73
 Sets Build Screen, 73
Source option, 10
 Special features keys, 59
 Special Features keys, 8
 Special Features Keys, 23
 Specifications, 162
Speed Enhancement T, 2
 Speeds, 165
 SRGB, 103
 Stand, 4
 Standard Organizer, 4
 Standard Stacker, 6
Start key, 23
 Status LED, 6
Stop key, 23
 Store/Recall key, 61
 Store/Recall Screen, 61
Synchro mode, 12
 SYSTEM ADMINISTRATION, 93
 SYSTEM ADMINISTRATION menu, 112
 System Administration menu options, 172
 SYSTEM ADMINISTRATION option, 112
 System Administration Screen, 113
 SYSTEM DESCRIPTION, 107
 SYSTEM DESCRIPTION option, 108
 System Description Screen, 108
 SYSTEM INFORMATION, 93
 System Information menu, 107
 System Information menu options, 172
 SYSTEM INFORMATION option, 107
 System Information Screen, 107
 System Screen, 113
 TAB OPTIONS, 70
 Tab Options Screen, 71
 Template is in Use Screen, 65
 Thick Document Lever, 4
 TIMERS, 94
 TIMERS option, 103
 Timers Screen, 104
 TITLE BLOCK LOCATION, 72

Title Block Location Screen, 72
TRANSFORM, 76
Transform key, 76
TRANSFORM MENU, 76
Transform Menu Screen, 76
TRANSFORM option, 79
Transform Screen, 80, 81
translucent media, 37
Type Line, 42
Type option, 10, 14, 40
Type Photo, 43
Type, Color, 44
Type, Normal, 41
Understanding the READY TO
SCAN screen, 87

USAGE METERS, 119, 120
Usage Meters Screen, 120
WEB, 46
WIDE DOCUMENTS, 57
WIDE FORMAT SCAN
SYSTEM Front View, 4
WIDE FORMAT SCAN
SYSTEM Rear View, 5
Width Found for Set is XX.X
Screen, 75
WRITE NVR, 121
WRITE NVR option, 125
Write NVR Screen, 125

This page intentionally left blank.

