

JVC



MICRO COMPONENT SYSTEM

微型组合音响

UX-M6V

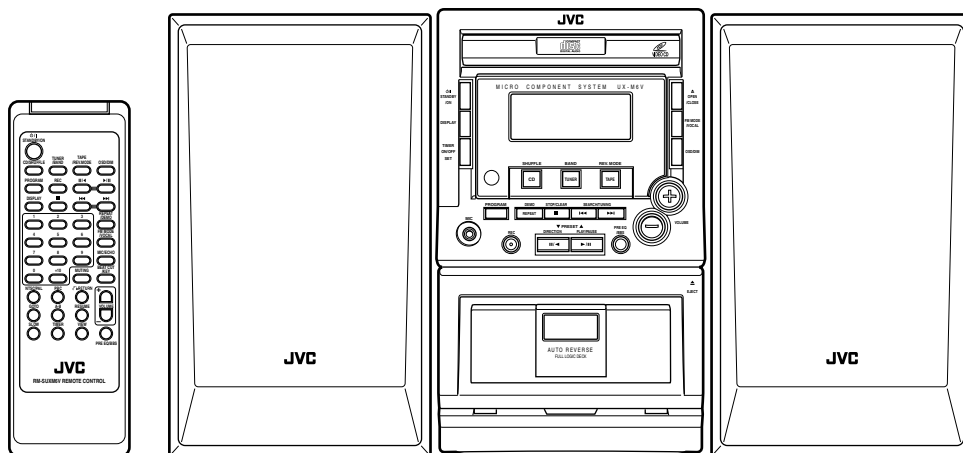

INSTRUCTIONS

使用说明书

For Customer Use:

Enter below the Model No. and Serial No. which are located either on the rear, bottom or side of the cabinet. Retain this information for future reference.

Model No. _____

Serial No. _____

LVT0809-001A
[US, UB]

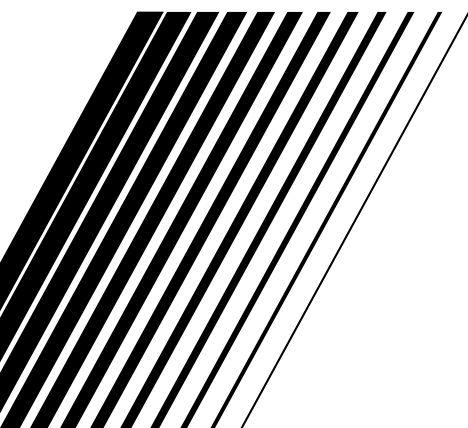

Warnings, Cautions and Others

警告，注意及其他须知事项

Caution — STANDBY/ON button!

Disconnect the mains plug to shut the power off completely. The STANDBY/ON  button in any position does not disconnect the mains line. The power can be remote controlled.

注意— 开关！

无论  开关在任何位置，电源线的电源还是没有被切断，若要将电源完全关闭，应把电源插头拔离插座。电源开关可用遥控器控制。

CAUTION

To reduce the risk of electrical shocks, fire, etc.:

1. Do not remove screws, covers or cabinet.
2. Do not expose this appliance to rain or moisture.

警告

为了减低触电，火灾等危险：

1. 请勿擅自卸下螺丝钉，盖子或机壳。
2. 切勿让本机受雨淋或置潮湿环境中。

CAUTION

- Do not block the ventilation openings or holes. (If the ventilation openings or holes are blocked by a newspaper or cloth, etc., the heat may not be able to get out.)
- Do not place any naked flame sources, such as lighted candles, on the apparatus.
- When discarding batteries, environmental problems must be considered and local rules or laws governing the disposal of these batteries must be followed strictly.
- Do not use this apparatus in a bathroom or places with water. Also do not place any containers filled with water or liquids (such as cosmetics or medicines, flower vases, potted plants, cups, etc.) on top of this apparatus.

注意

- 请勿堵塞通风口或通风孔。
(如果通风口或通风孔被报纸或布等堵塞，热量将无法散出。)
- 请勿在本设备上放置任何裸露的火源，如点燃的蜡烛。
- 处理废弃电池时，必须考虑环境问题，并严格遵守当地关于处理废弃电池的有关法律或规定。
- 请勿在浴室里或有水汽的地方使用本设备。亦请勿在本设备的上方放置任何装有水或液体的容器（如化妆品，药品，花瓶，花盆，杯子等）。

IMPORTANT FOR LASER PRODUCTS

雷射产品的重要说明

REPRODUCTION OF LABELS / 标签内容说明

① CLASSIFICATION LABEL, PLACED ON REAR ENCLOSURE

① 分类标签，贴在机壳背后



② WARNING LABEL, PLACED INSIDE THE UNIT

② 警告标签，贴于机内

DANGER-Invisible laser radiation when open and interlock defeated. AVOID DIRECT EXPOSURE TO BEAM.	VARO! Avattaessa ja suojalukitus ohitettaessa olet alltiina nädkmätön läsersateilylle. Älä katso säteeseen.
VORSICHT-Unsichtbare Laserstrahlung, wenn Abdeckung geöffnet und Sicherheitsverriegelung überbrückt. Nicht dem Strahl aussetzen.	VARNING! Osymilg laserstrålning när denna del är ösppad och spärren är urkopplad. Beträka ej strålen.
ADVARSEL-USYNLIG LÅSERSTRALING VED ÅBNING. NÅR SIKKERHEDSAFBRYDERE ER UDE AF FUNKTION. UNDGÅ UDSÆTTELSE FOR STRÅLING.	ADVERSEL! Usynlig laserstrålning når deksel åpnes og slikkshedsås brytes. Unngå eksponering for sirålen. A pleine puissance. l'ecoute prolongee du baladeur peut endommager l'oreille de l'utilisateur.

1. CLASS 1 LASER PRODUCT
2. **DANGER:** Invisible laser radiation when open and interlock failed or defeated. Avoid direct exposure to beam.
3. **CAUTION:** Do not open the top cover. There are no user serviceable parts inside the Unit; leave all servicing to qualified service personnel.

1. 一级雷射产品
2. **危险：**当内部锁定装置失效或者损坏后，打开盖板可能会产生不可见的雷射辐射。应避免受到光束直接照射。
3. **注意：**请勿打开顶盖板。本机内部没有用户可自行维修的部件；所有维修工作应由有资格的人员完成。

Caution: Proper Ventilation

To avoid risk of electric shock and fire, and to prevent damage, locate the apparatus as follows:

1 Front:

No obstructions and open spacing.

2 Sides/ Top/ Back:

No obstructions should be placed in the areas shown by the dimensions below.

3 Bottom:

Place on the level surface. Maintain an adequate air path for ventilation by placing on a stand with a height of 10 cm or more.

注意：正确通风

为免发生触电和火警的危险，及防止本机受损，请将本机如下放置：

1. 前面： 没有障碍物及地方开阔。
2. 侧面/顶面/背面： 在图中所示范围中，不应放置任何障碍物。
3. 底部： 放置在水平面上。放置在一个高 10 厘米或以上的台上，以保持足够的通风道。

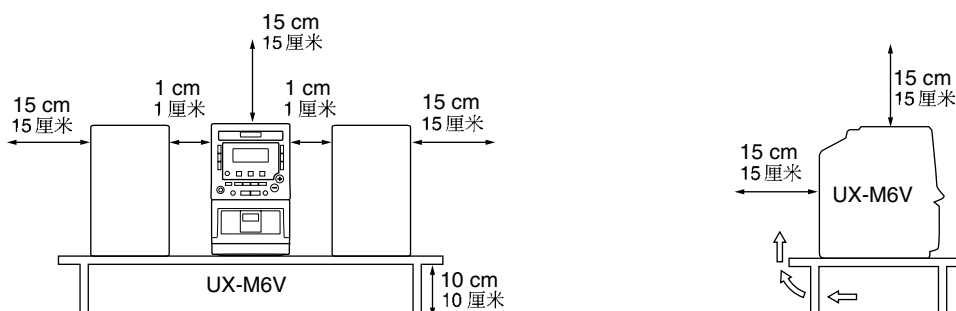

Introduction

We would like to thank you for purchasing one of our JVC products. Before operating this unit, read this manual carefully and thoroughly to obtain the best possible performance from your unit, and retain this manual for future reference.

About This Manual

This manual is organized as follows:

- The manual mainly explains operations using the buttons and controls on the unit. You can also use the buttons on the remote control if they have the same or similar names (or marks) as those on the unit. If operation using the remote control is different from that using the unit, it is then explained.
- Basic and common information that is the same for many functions is grouped in one place, and is not repeated in each procedure. For instance, we do not repeat the information about turning on/off the unit, setting the volume, changing the sound effects, and others, which are explained in the section “Common Operations” on pages 8 and 9.
- The following marks are used in this manual:



Gives you warnings and cautions to prevent a damage or risk of fire/electric shock. Also gives you information on operation which is not good for obtaining the best possible performance from the unit.



Gives you information and hints you had better know.

Precautions

Installation

- Install in a place which is level, dry and neither too hot nor too cold — between 5°C and 35°C.
- Install the unit in a location with adequate ventilation to prevent internal heat built-up in the unit.
- Leave sufficient distance between the unit and the TV.
- Keep the speakers away from the TV to avoid interference with TV.



DO NOT install the unit in a location near heat sources, or in a place subject to direct sunlight, excessive dust or vibration.

Power sources

- When unplugging from the wall outlet, always pull the plug, not the AC power cord.



DO NOT handle the AC power cord with wet hands.

Moisture condensation

Moisture may condense on the lens inside the unit in the following cases:

- After starting heating in the room
 - In a damp room
 - If the unit is brought directly from a cold to a warm place
- Should this occur, the unit may malfunction. In this case, leave the unit turned on for a few hours until the moisture evaporates, unplug the AC power cord, and then plug it in again.

Others

- Should any metallic object or liquid fall into the unit, unplug the unit and consult your dealer before operating any further.
- If you are not going to operate the unit for an extended period of time, unplug the AC power cord from the wall outlet.



DO NOT disassemble the unit since there are no user serviceable parts inside.

If anything goes wrong, unplug the AC power cord and consult your dealer.

Location of the Buttons and Controls	3
Front Panel	4
Remote Control	5
Getting Started	6
Unpacking	6
Putting the Batteries into the Remote Control	6
Connections	6
Common Operations	8
Turning On or Off the Unit	8
Setting the Clock	8
Adjusting the Volume	8
Demonstration Mode	9
Dim Mode	9
Digital Sound Control	9
Listening to FM and AM Broadcasts	10
Tuning In a Station	10
Presetting Stations	10
Tuning In a Preset Station	11
Playing Back CDs/VCDs/MP3-CDs	12
Loading a Disc	12
Adjusting the TV system	12
Playing Back a Disc	13
Program Play of a CD/VCD	13
Program Play of a MP3-CD	14
Shuffle Play	14
Repeat Play	14
On Screen Display (OSD) for a CD/VCD	15
Playing a VCD with PBC	15
Various VCD Operations	15
Playing Back Tapes	17
Loading a Tape	17
Tape Playback	17
Auto Reverse	17
Rewind/Fast Forward	17
Recording	18
Recording Tapes	18
Karaoke	19
Microphone Mixing	19
Audio Channel Selection	19
MIC Volume and Echo	19
Key	19
Using the Timers	20
Using Daily Timer	20
Timer Recording	20
Using Sleep Timer	21
Maintenance	22
Troubleshooting	23
Specifications	23

Location of the Buttons and Controls



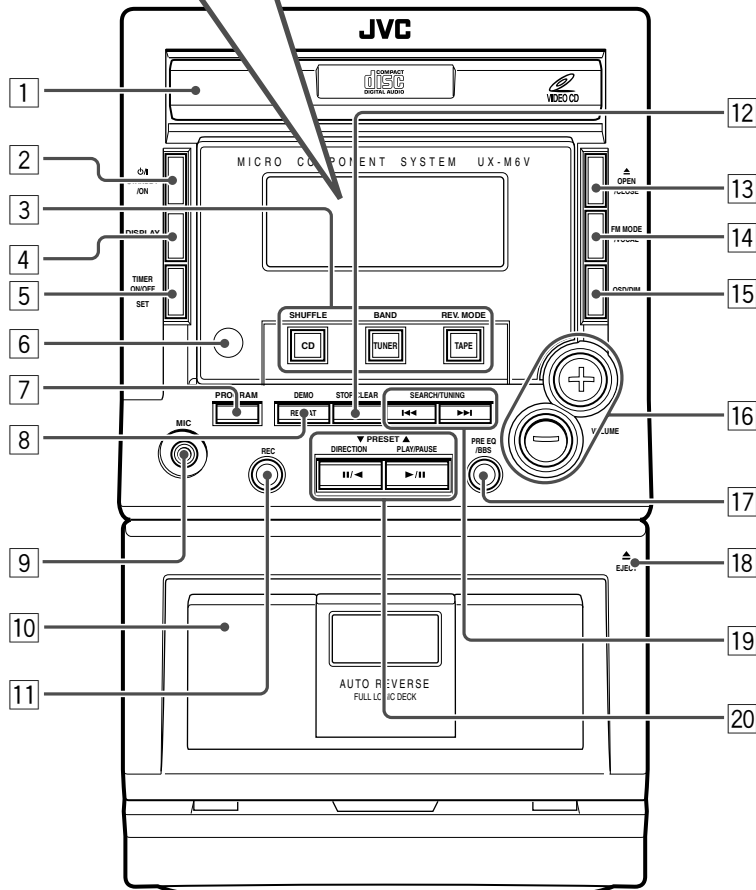
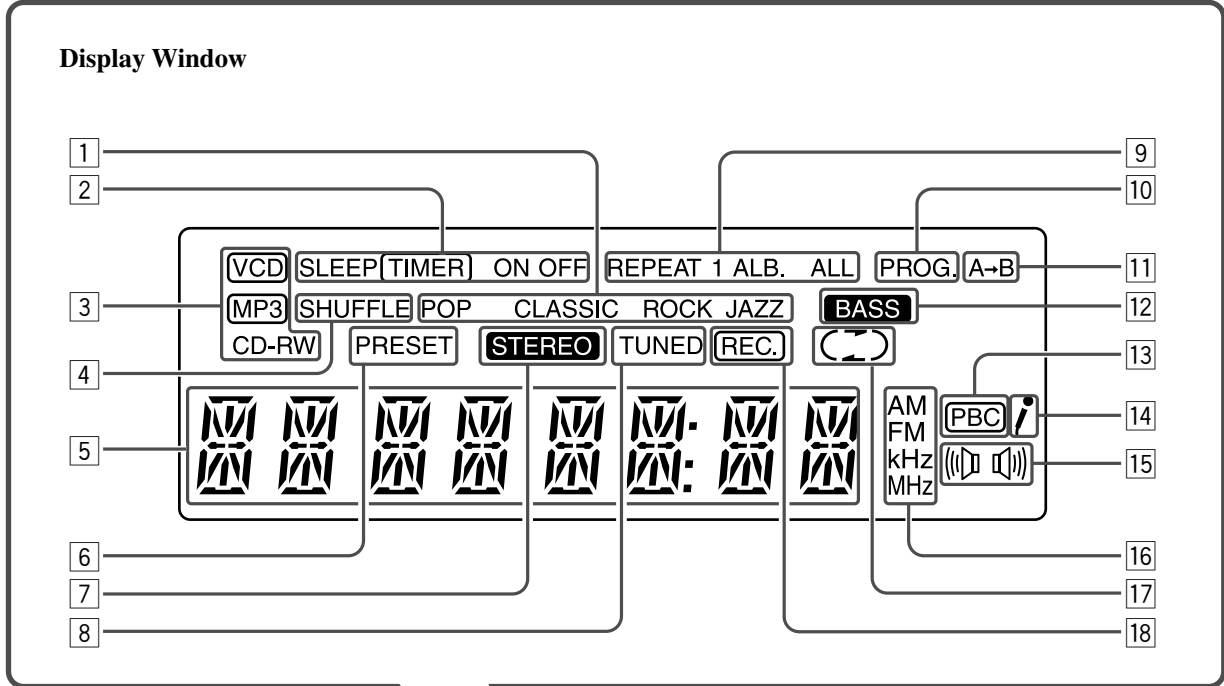

Become familiar with the buttons and controls on your unit.









Front Panel



Front Panel

See pages in the parentheses for details.

- 1 Disc compartment (12)
- 2  STANDBY/ON button (8)
Turns the unit on or off (standby mode).
- 3 CD/SHUFFLE button (12, 14)
*Selects CD/VCD mode.
Starts or stops shuffle play in CD/VCD mode.*
TUNER/BAND button (10)
*Selects tuner mode.
Selects FM or AM in tuner mode.*
TAPE/REV.MODE button (17)
*Selects tape mode.
Selects auto reverse mode.*
- 4 DISPLAY button (8, 21)
*Displays the clock.
Selects the time length until the unit is turned off.*
- 5 TIMER ON/OFF SET button (20)
Activates/deactivates the timer or sets the timer.
- 6 Remote sensor (5)
Infrared sensor for remote control
- 7 PROGRAM button (8, 10, 13, 20)
*CD/VCD/MP3-CD: programs the track playback order.
Tuner: presets radio stations.
Clock/Timer: sets or resets the clock/timer.*
- 8 REPEAT/DEMO button (9, 14)
*CD/VCD/MP3-CD: repeats a track, an album or the whole disc.
Activates/deactivates the demonstration.*
- 9 MIC (Microphone) jack (19)
Connect the microphone to this jack.
- 10 Tape deck (17)
- 11 REC  (Recording) button (18)
Switches to record ready state.
- 12 STOP/CLEAR  button (13, 17, 18)
*CD/VCD/MP3-CD: stops playback or clears the program.
Tape: stops playback or recording.*
- 13  OPEN/CLOSE button (12)
Opens/closes the disc compartment.
- 14 FM MODE/VOCAL button (10, 19)
*CD/VCD: sets vocal mode.
Tuner: switches between stereo and monaural mode (on FM band only).*
- 15 OSD/DIM button (9, 15)
*Switches on or off the on-screen display on the TV screen.
Selects DIM HIGH, DIM LOW or LED OFF.*
- 16 VOLUME +/- buttons (8)
Adjust the volume, echo or key tone level.
- 17 PRE EQ/BBS button (9)
*Selects the desired sound mode.
Switches on or off the BBS system.*
- 18  EJECT (17)
Opens the tape deck door.

- 19 SEARCH/TUNING  buttons (8, 10, 13, 17, 20)
*MP3-CD: select previous/next album or track.
CD/VCD: search backward/forward or skip to the beginning of the current/previous/next track.
Tuner: tune to a lower or higher radio frequency or search radio stations.
Tape: rewind or fast forward.
Clock: set the hour and minute.
Timer: set the timer function.*
- 20 PRESET  /  buttons (10)
Tuner: select a preset radio station.
DIRECTION  /  and  /  buttons (17, 18)
Tape: start playback or recording in the selected direction.
PLAY/PAUSE  button (13, 17)
*CD/VCD/MP3-CD: starts or interrupts playback.
Tape: pauses playback.*

Display window

- 1 Sound mode indicators (9)
POP, CLASSIC, ROCK, JAZZ
- 2 Timer indicators (20, 21)
SLEEP, TIMER, ON, OFF
- 3 Disc indicators (12)
VCD, MP3, CD-RW
- 4 SHUFFLE indicator (14)
- 5 Main display
- 6 PRESET indicator (10)
- 7 STEREO indicator (10)
- 8 TUNED indicator (10)
- 9 Repeat indicators (14)
REPEAT 1, ALB., ALL
- 10 PROG. (Program) indicator (13, 14)
- 11 A→B repeat indicator (16)
- 12 BASS indicator (9)
- 13 PBC indicator (15)
- 14 Microphone indicator (19)
- 15 STEREO/VOCAL indicator (19)
- 16 Band/station indicators (10)
- 17 Tape direction indicator (17, 18)
- 18 REC. (Recording) indicator (18)

Remote Control

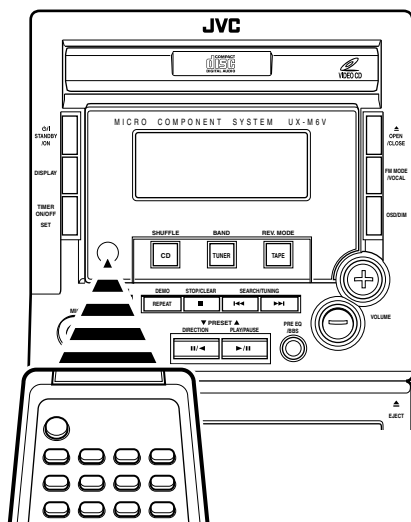
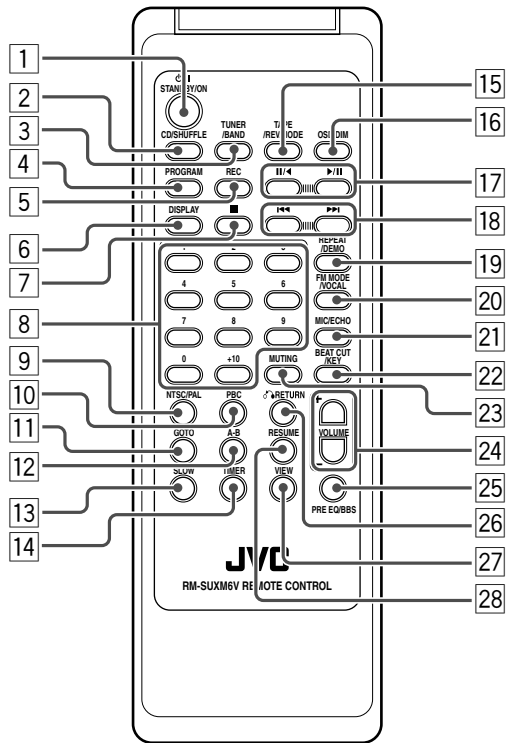

When using the remote control, point it at the remote sensor on the front panel.

Remote Control

- 1 STANDBY/ON button
- 2 CD/SHUFFLE button
- 3 TUNER/BAND button
- 4 PROGRAM button
- 5 REC (Recording) button
- 6 DISPLAY button
- 7 ■ button
- 8 Number buttons
CD/VCD/MP3-CD: select a track number.
Tuner: select a preset radio station.
- 9 NTSC/PAL button
Selects the video output for NTSC or PAL.
- 10 PBC (Playback Control) button
Switches on/off PBC (for VCD version 2.0 only).
- 11 GO TO button
CD/VCD: starts playback at the desired time point on the disc.
- 12 A-B button
Plays back a certain scene or passage of a CD/VCD repeatedly.
- 13 SLOW button
Displays a VCD at a slower speed.
- 14 TIMER button
- 15 TAPE/REV.MODE button
- 16 OSD/DIM button
- 17 and buttons
- 18 and buttons
- 19 REPEAT/DEMO button
- 20 FM MODE/VOCAL button
- 21 MIC/ECHO button
Displays and sets the MIC volume level and echo level for Karaoke.
- 22 BEAT CUT/KEY button
Displays and sets the key tone level.
- 23 MUTING button
Interrupts and resumes sound reproduction.
- 24 VOLUME +/- buttons
- 25 PRE EQ/BBS button
- 26 RETURN button
Returns to the previous MENU level during playback of a VCD with PBC.
- 27 VIEW button
Scans through a VCD when PBC is off.
- 28 RESUME button
Resumes playback of a CD/VCD when PBC is off.

Unpacking

After unpacking, check to be sure that you have all the following items.

The number in the parentheses following each item name indicates the supplied quantity.

- Remote control (1)
- Batteries (R03 (UM-4)/AAA (24F)) for remote control (2)
- AM loop antenna (1)
- FM wire antenna (1)
- AC plug adaptor (1)

If any is missing, consult your dealer immediately.

Putting the Batteries into the Remote Control

Insert 2 batteries — R03 (UM-4)/AAA (24F) — into the battery compartment of the remote control, complying with the + and – polarity markings inside the battery compartment. When the remote control can no longer operate the unit, replace both batteries at the same time.

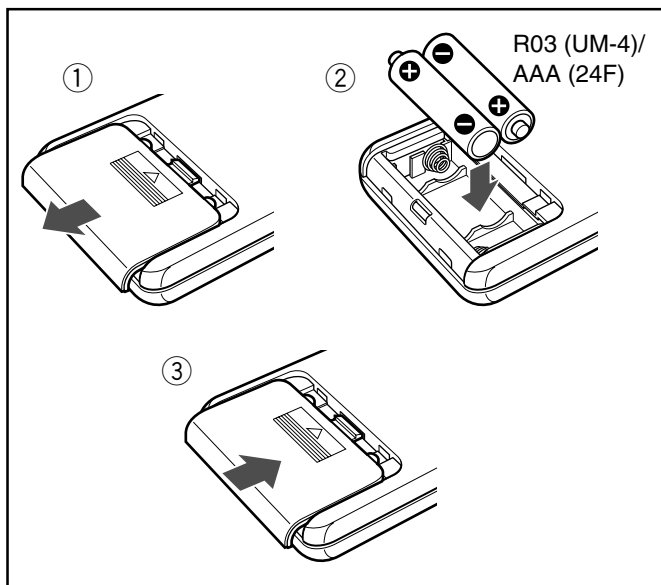

- DO NOT use an old battery together with a new one.
- DO NOT use different types of batteries together.
- DO NOT expose batteries to heat or flame.
- DO NOT leave the batteries in the battery compartment when you are not going to use the remote control for an extended period of time; otherwise, the remote control may be damaged by battery leakage.

Connections



- DO NOT connect any equipment to the unit while the unit is powered.
- DO NOT plug in any equipment until all connections are completed.

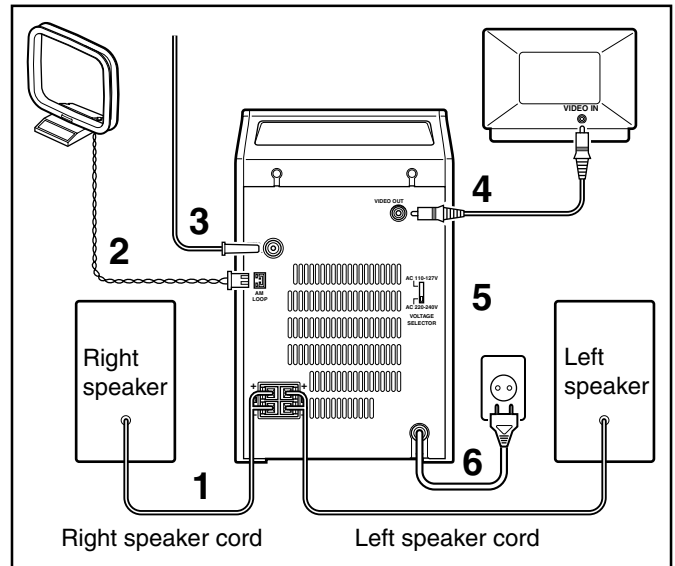

1 Connect the speakers.

Connect the right speaker to the “R” terminals, with the red wire to + and the black wire to –.

Connect the left speaker to the “L” terminals in the same way.

Clip the stripped portion of each speaker wire as shown in the illustration.

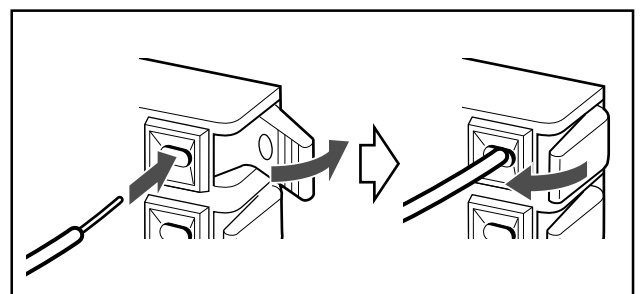

2 Connect the supplied AM loop antenna to the AM LOOP terminal.

Place the antenna away from the unit and adjust its position for the best reception.

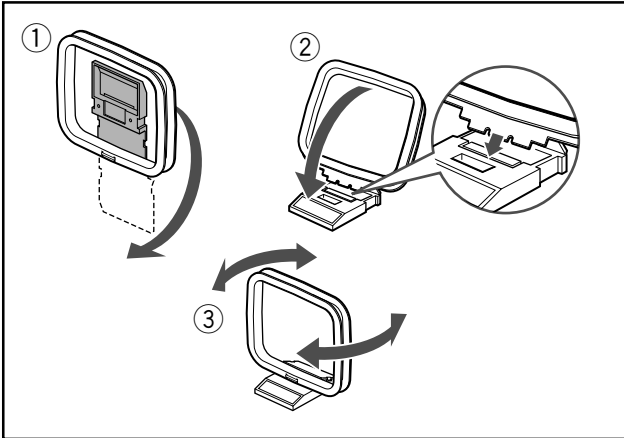

3 Connect the supplied FM wire antenna to the FM 75 Ω COAXIAL jack.

Adjust the position of the FM antenna for the best reception.

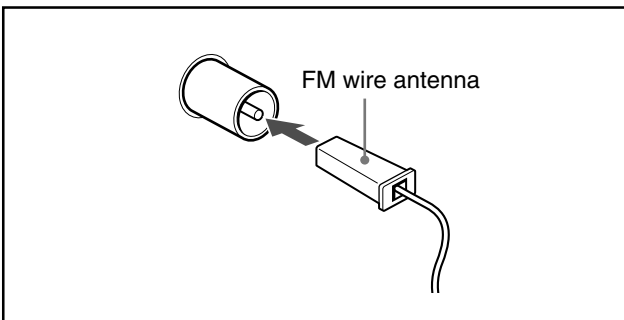

Outdoor antenna

For better FM stereo reception, connect an outdoor FM antenna to the FM 75 Ω COAXIAL jack using a 75 Ω coaxial wire.

4 Connect the VIDEO OUT jack at the rear of the unit to the TV using a video connecting cord (not supplied).

5 Set the voltage selector to the local power line voltage (for specific version only).

6 Connect the AC power cord of the unit to the AC outlet after all other connections have been made.

Turning On or Off the Unit

To turn on the unit

Press  STANDBY/ON on the unit or remote control.

The unit turns on with the last source selection remaining valid.

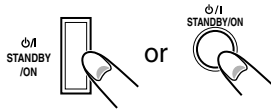

To turn off the unit (on standby)

Press  STANDBY/ON on the unit or remote control. "BYE BYE" scrolls through briefly and the clock time appears if the clock is already set.

Setting the Clock

Before operating the unit any further, first set the built-in clock.

- There is a time limit in doing the following steps. If the setting is canceled before you finish, start from step 1 again.

1 While the unit is on, press and hold PROGRAM until "24" or "12" HOUR starts blinking.



- When the unit is in standby mode, press PROGRAM once.

2 Press or to select 12- or 24-hour mode, then press PROGRAM.

The hour indication starts blinking.

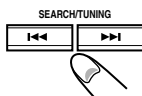



3 Press or to set the hour then press PROGRAM.

The minute indication starts blinking.



4 Press or to set the minute, then press PROGRAM to store the setting.

The clock starts working.

To change the hour or minute indication rapidly in steps 3 and 4, press and hold  or .

To check the clock time while the unit is on

Press DISPLAY.

The clock time is displayed until you press any key.

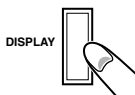

- In 12-hour mode, "AM 12:00" indicates midnight and "PM 12:00" indicates noon.

To correct the clock time

Carry out steps 1 to 4 above.



On clock resetting

If a power failure occurred or the AC power cord is disconnected, the clock is reset to "0:00" (flashing). In such a case you need to set the clock again.

Adjusting the Volume

- You can adjust the volume only while the unit is turned on.

Press VOLUME + or VOLUME - to increase or decrease the volume level.



The volume can be adjusted in 33 steps between "VOL MIN" (minimum) and "VOL MAX" (maximum).

To increase or decrease the volume level rapidly, press and hold VOLUME + or VOLUME -.

To turn off the sound temporarily

Press MUTING on the remote control. The source name and muting indication scroll through the display, and playback continues without sound.



To restore the sound, press MUTING again or increase or decrease the volume level.



DO NOT turn off the unit (on standby) with the volume set to an extremely high level; otherwise, a sudden blast of sound can damage your hearing and/or the speakers when you turn on the unit or start playing any source next time.

Demonstration Mode

The unit has a demonstration mode that shows various features offered by the unit.

To activate the demonstration

In standby mode, press REPEAT/DEMO.
The demonstration begins.



To deactivate the demonstration

Press REPEAT/DEMO again or  STANDBY/ON.



Dim Mode

You can select the desired brightness for the display.

To select the dim mode

Turn on the unit and press and hold OSD/DIM until “DIM HIGH,” “DIM LOW” or “LED OFF” appears.

Each time you do this, the dim mode selection changes as follows:

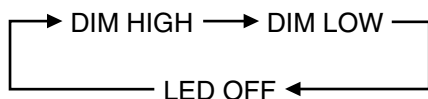

Dim mode selected	Brightness of the display window	LED on the source buttons*
DIM HIGH	High	ON
DIM LOW	Low	ON
LED OFF	Low	OFF

* Source buttons: CD/SHUFFLE, TUNER/BAND and TAPE/REV.MODE buttons on the unit (3) on page 3)

Digital Sound Control

The unit's digital sound control feature enables you to select desired preset equalizer settings (selectable as sound modes) to enjoy special sound effects matching the music type. You can also use the BBS system to enjoy powerful bass sound created by emphasizing low frequencies.

To select the desired sound mode

Press PRE EQ/BBS repeatedly.



Each time you press the button, the sound mode changes as follows:

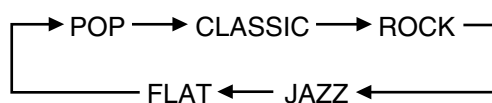

POP: More presence in the vocals and midrange

CLASSIC: Enriched sound with fine treble and ample bass

ROCK: Powerful sound emphasizing treble and bass

JAZZ: Accented lower frequencies for jazz-type music

FLAT: Equalizer effect is canceled.

To switch the BBS system on/off

Press and hold PRE EQ/BBS until “BBS ON” or “BBS OFF” appears on the display.

When the BBS system is switched on, the BASS indicator lights up on the display.



Tuning In a Station

1 Press TUNER/BAND to select tuner mode.

The unit automatically turns on, and tunes in the last station tuned in (either FM or AM).

2 Press TUNER/BAND to select the band, FM or AM.

Each time you press the button, the band selection alternates between FM and AM.



3 Press and hold ◀◀ or ▶▶ until "SEARCH" appears, then release the button.

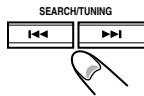

The unit starts searching for stations.

When a station of sufficient signal strength is tuned in, searching stops and the TUNED indicator lights up on the display.

If a program is broadcast in stereo, the STEREO indicator lights up.

To stop searching, press ◀◀ or ▶▶.



When you press ◀◀ or ▶▶ briefly and repeatedly the frequency changes step by step.

To improve the FM reception

When an FM stereo broadcast is hard to receive or noisy, press FM MODE/VOCAL to switch to the monaural reception. The STEREO indicator disappears from the display.



To restore the stereo reception, press FM MODE/VOCAL again so that the STEREO indicator lights up.

To change FM/AM tuning interval

The unit's default tuning interval is 50 kHz/step for FM reception and 9 kHz/step for AM. You can change this setting when using the unit in an area where the frequency allocation is 100 kHz/step for FM stations and 10 kHz/step for AM stations.

- 1 Unplug the AC power cord.
- 2 Press and hold ▶/|| and VOLUME – on the unit simultaneously.
- 3 Plug in the AC power cord.
- 4 Release the buttons.

To switch the tuning interval back to 50 kHz/step (FM) and 9 kHz/step (AM), follow the same procedure above except in step 2 where you press and hold ||/◀ and VOLUME + simultaneously.

Presetting Stations

You can preset 20 FM and 10 AM stations.

- There is a time limit in doing the following steps. If the setting is canceled before you finish, start from step 1 again.

1 Tune in the station you want to preset.

- See "Tuning in a Station" on the left.

2 Press PROGRAM.

The PRESET indicator and the current preset number start blinking on the display.



3 If you want to change the preset number, press ||/◀ or ▶/|| repeatedly until the desired preset number appears.

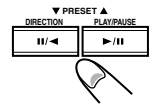

- Alternatively, use the number buttons on the remote control.
To select preset number 5, press 5.
To select preset number 12, press +10 and then 2.
To select preset number 20, press +10, +10 and then 0.

4 Press PROGRAM again to store the radio station.

"STORED" scrolls through briefly. The PRESET indicator lights up steadily.



5 To preset more stations, repeat the steps above, allocating a different preset number to each station.



When a new station is stored

The station previously memorized with the same preset number is erased. (The frequency of the new station replaces the previous frequency in memory.)

Tuning In a Preset Station

- 1 Press **TUNER/BAND** to select tuner mode.



- 2 Press **TUNER/BAND** to select the band, FM or AM.

- 3 Press **II/◀** or **▶/II** repeatedly to select the desired preset number.

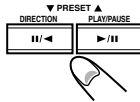

- Alternatively, use the number buttons on the remote control.
To select preset number 5, press 5.
To select preset number 12, press +10 and then 2.
To select preset number 20, press +10, +10 and then 0.

This unit can play back all digital audio CDs, video CDs (VCDs), finalized digital audio CD-Recordable (CD-R) discs and finalized digital audio CD-Rewritable (CD-RW) discs.



NOTES ON CD-R AND CD-RW DISCS

- When playing back a CD-R or CD-RW disc on this unit, it must be “finalized” so that it can be played back correctly.
“Finalization” is a process to create a TOC (Table Of Contents) section on a recorded disc. If you attempt to play back a non-finalized disc, especially a non-finalized CD-RW disc on this unit, malfunction may occur since no TOC section exists on the disc.
- When a non-finalized CD-R or a CD-RW disc is loaded or ejected, it may take a considerably long time to read the disc, but it is not a malfunction.
- This unit does not support track skipping function. Even if a CD-R disc or a CD-RW disc is designed to skip some tracks during playback, this unit does not skip such tracks.



- **MP3-CD formats supported on this unit**
 - ISO 9660 format – 17 characters max.
 - Number of tracks plus number of albums: 256 max.
 - Number of directory nesting levels: 8 max.
 - Number of albums: 99 max.
 - Number of MP3 program tracks: 99 max.
 - Length of each track: 255 minutes 59 seconds max.
 - The player can play mixed mode disc:
 - a: MP3 + CD/DA can only play the MP3 tracks in the first block
 - b: VCD + CD/DA
 - VBR bit-rate
 - Sampling frequencies for MP3 disc: 32 kHz, 44.1 kHz, 48 kHz
 - Bit rates of MP3 disc : 32, 64, 96, 128, 192, 256 (kbps)
- **MP3-CD formats not supported on this unit**
 - Files like *WMA, *AAC, *DLF, *M3U, *PLS
 - Chinese filenames
 - Non-session closed discs
 - Discs recorded in UDF format
 - Multi-session discs (can only play the first session if it is in the supported format.)



Before playing back video CDs (VCDs)

The CD part of this unit also serves as a VCD player if you connect it to your TV set.
Before viewing a VCD, ensure that the TV standard, NTSC or PAL, on which your TV set is based has been selected on this unit. This is not necessary when you use a multi-system TV set.

Loading a Disc

1 Press CD/SHUFFLE to select CD/VCD mode.

The unit automatically turns on.



- Switch on the connected TV when loading a VCD.

2 Press OPEN/CLOSE.

The disc tray slides out.



3 Load a disc with the label side facing up.

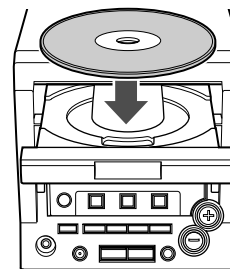

4 Press OPEN/CLOSE to close the disc compartment.

The total number of tracks and the playing time of the disc appear on the display. For VCD, MP3-CD and CD-RW, the disc indicator lights up.



When loading an MP3-CD format music disc

The MP3 indicator lights up and the total number of albums and total number of tracks scroll through the display, then “A01 T001” is displayed.

On the TV screen, the total number of albums (ALB), the total number of tracks (TRK), and an album list (up to 5 lines per page) with an arrow pointing at the currently selected album are displayed.

When an MP3-CD is loaded in the disc compartment, it may take more than 30 seconds to be read in, depending on the amount of information compiled in the disc. To ensure good system performance, wait until the disc is completely read in before proceeding further.

Adjusting the TV System

To view a VCD or display OSD information (see page 15) on the TV screen correctly, the NTSC/PAL setting of the unit must comply with your TV set. (This is not the case when you use a multi-system TV set.)

After loading a disc, press **NTSC/PAL** on the remote control as required to change the setting to “NTSC” or “PAL”.



Playing Back a Disc

1 Load a disc.

- See “Loading a Disc” on the previous page.

2 Press ►/II to start playback.

The track number and elapsed playing time of the current track appear on the display.



3 To stop playback, press ■.

To interrupt playback

Press ►/II.

The playing time starts blinking.



To resume playback, press ►/II again.

To select a desired track (for CD and VCD)

Press ◀◀ or ▶▶ repeatedly until the desired track appears on the display (or press the number buttons on the remote control).

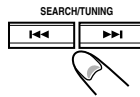

- If you use the number buttons to select a track, playback will start immediately without your pressing ►/II.

To search for a particular point during playback (for audio CD only)

Press and hold ◀◀ or ▶▶ to locate the desired point on the disc.

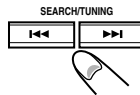

To search for a particular scene during playback (for VCD only)

- 1 Press and hold ◀◀ or ▶▶ until the search speed indication appears on the TV screen. Each time you do this, the search speed changes as follows:

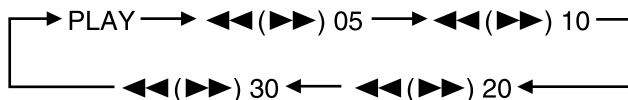

- 2 When you locate the desired scene, press ►/II.

To select a desired album (for MP3-CD only)

In stop mode, press and hold ◀◀ or ▶▶ until the desired album number appears on the display.

“ALBUM” and the album name scroll through the display briefly.

On the TV screen, the arrow moves up/down in the album list.



To select a desired track (for MP3-CD only)

In stop mode, press ◀◀ or ▶▶ repeatedly (or press the number buttons on the remote control) to select a desired track from the current album.

The track name scrolls through the display briefly.

On the TV screen, the arrow moves up/down in the track list of the current album.

Press ►/II to start playback.



- If you use the number buttons to select a track, playback will start immediately without your pressing ►/II.

Program Play of a CD/VCD

You can arrange the order in which the tracks are played before you start playing. You can program up to 20 tracks.

1 In stop mode, press PROGRAM.

The PROG. indicator and the current selected track number start blinking.



2 Press ◀◀ or ▶▶ repeatedly (or press the number buttons on the remote control) to select the desired track.



3 Press PROGRAM to store the selected track.

“PXX OK” appears on the display and TV screen.

4 Repeat steps 1 to 3 to store other tracks.

- When programming tracks of a VCD with PBC, the PBC function is automatically switched off.
- You cannot program more than 20 tracks. If you attempt to do it, “PRG FULL” will flash on the display.

To play the programmed tracks

Press ►/II.



- During program play, you can press ◀◀ or ▶▶ to select the desired track in the program.



If you press REPEAT/DEMO during program play

The current track or all programmed tracks are played repeatedly.



To review the programmed sequence

Press ◀◀ or ▶▶ repeatedly after pressing ■ in program play mode.

The program number and track number are displayed in succession.



To clear the program

Press  in stop mode.
"PROG CLEARED" scrolls through the display and the PROG. indicator goes off.



- The stored program is cleared when the CD compartment is opened.



On the display, "P" represents PROGRAM and "T" represent TRACK. In this manual, "XX" is the current selected program or track number.

Program Play of a MP3-CD

1 In stop mode, press PROGRAM.

The PROG. indicator starts blinking on the display.

On the TV screen, "PXX AXX TXXX?" and "PROGRAM" appear.



2 Press and hold or to select the desired album.

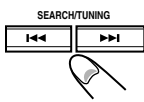

3 Press or repeatedly (or press the number buttons on the remote control) to select the desired track.

4 Press PROGRAM to store the selected track.

On the display "PXX OK" appears briefly, then the programmed album number and track number appear. The PROG. indicator lights up steadily.



5 Repeat steps 1 to 4 to store other albums and tracks.

To start program play

Press .



To review the programed sequence

Press  or  repeatedly during program play or after pressing . Each time you press the button, "PXX AXX TXXX" scrolls through the display briefly.



To clear the program

Press  in stop mode.
"PROG CLEARED" appears on the display and the PROG. indicator goes off.



- The stored program is cleared when the CD compartment is opened.

Shuffle Play

You can play all the tracks in random order.

In play mode, pause or stop mode, press CD/SHUFFLE.

The SHUFFLE indicator lights up.



To exit shuffle play mode, press CD/SHUFFLE again or . The SHUFFLE indicator goes off.

- It is not possible to activate the shuffle play function during program play.
- Activating the repeat play function during shuffle play disables the shuffle play mode.
- For VCDs with PBC, activating the shuffle play function automatically switches off PBC.

Repeat Play

You can play the current track, album (for MP3-CD only) or the whole disc repeatedly.

In play or pause mode, press REPEAT/DEMO to select one of the following repeat play modes:

- REPEAT 1: repeats the current track.
- REPEAT ALL: repeats the whole disc.
- REPEAT ALB. (for MP3-CD only): repeats the current album.



The current track, album (for MP3-CD only) or the whole disc is played repeatedly until you press .

To exit repeat play mode, press REPEAT/DEMO repeatedly so that the REPEAT indicator disappears from the display. Alternatively, press .

- Activating the shuffle play function during repeat play disables any repeat play mode.

On Screen Display (OSD) for a CD/VCD

If you insert a CD/VCD, your TV screen will serve as an additional display for messages (such as PLAY, STOP, etc.) and information stored on the VCD/CD.

Press OSD/DIM repeatedly to select the information to display.

The current track number and the current/remaining time of the track/disc appear on the display.



Playing a VCD with PBC

When you load a VCD with PBC (Playback Control) in the disk compartment, the PBC indicator appears on the display. The PBC provides a play sequence predefined for the VCD.

1 Switch on the TV, then load a VCD with PBC.

A menu appears on the TV screen.

- If the menu consists of a list of titles, you can select the desired title directly.

2 Press the number buttons on the remote control to make selection.

The VCD starts playing the selected menu item automatically.

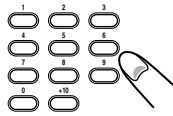

- If the menu consists of more than one page, press \llcorner or \lrcorner to go through the pages.

To return to the previous menu level

Press \curvearrowright RETURN on the remote control.



To switch off the PBC function

Press PBC on the remote control.

Alternatively, press \blacksquare .

“PBC OFF” appears briefly on the TV screen and the PBC indicator goes off.



- The PBC function is automatically switched off when you activate the shuffle play or VIEW function, or program tracks.



The menu structure depends on the program stored on the VCD. Refer to the information supplied with the disc.

Various VCD Operations

PAUSE

During playback, press $\blacktriangleright/\parallel$ to have a still picture on the TV screen.

The sound will be muted.

“PAUSE” appears briefly on the TV screen.



To continue playback, press $\blacktriangleright/\parallel$ again.

GO TO

This function allows you to start playback at the desired time point on the disc.

- To use the GO TO function, you need to switch off PBC beforehand.
- There is a time limit in doing the following steps. If the setting is canceled before you finish, start from step 1 again.

1 Press GO TO on the remote control.
“GO - -: -” appears on the display.



2 Press the number buttons on the remote control to enter the disc time at which to begin playback.

- The disc time entered should not be greater than the total disc time.

SLOW

Press SLOW on the remote control repeatedly to watch a VCD at a slower speed.

With each press, the playback speed changes as follows:

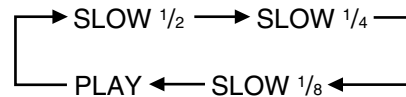

- The sound is muted.

To resume playback at normal speed, press $\blacktriangleright/\parallel$.

Alternatively, press SLOW repeatedly until “PLAY” appears on the TV screen.

A-B REPEAT

This feature is also applicable to the audio CD (except MP3-CD). A certain scene or passage of the disc can be played back repeatedly.

- 1 Press A-B on the remote control during playing a CD/VCD to mark the repeat start point.
“A→” lights up on the display.
“B” starts blinking.
 - 2 Press A-B again to mark the repeat end point.
“A→B” lights up steadily on the display.
The selected scene or passage is played repeatedly.
- The A-B repeat range can straddle two or more tracks except when using a VCD with PBC version 2.0. The VCD with PBC version 2.0 requires the A-B repeat start and end points to be in the same track.



To return to normal playback, press A-B.
“A→B” disappears from the display.

RESUME

This feature is also applicable to the audio CD (except MP3-CD).

In stop mode, press RESUME on the remote control to start playback again from where you have stopped.



- The resume function is not available if you have opened the disc compartment or disconnected the unit's power supply.

VIEW

This function allows you to scan through a VCD for a quick review. In view mode, the PBC function is automatically switched off.

Press VIEW on the remote control.
On the TV screen, 9 pictures are displayed. To view the previous/next page, press ◀◀ or ▶▶.
The first 20 seconds of each track is played.



To exit view mode, press the number buttons to play back the desired track, or ▶/|| to play the current selected track.

- If there's no video tracks on the viewed page, you cannot select the track directly using the number buttons.

Playing Back Tapes

- Use only type I normal tapes.



The use of tapes longer than 120 minutes is not recommended, since characteristic deterioration may occur and these tapes easily jam in the pinchrollers and the capstans.

Loading a Tape

- 1 Press **▲ EJECT** to open the tape deck door.

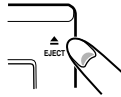

- 2 Insert a recorded tape with the open side down and close the tape deck door.

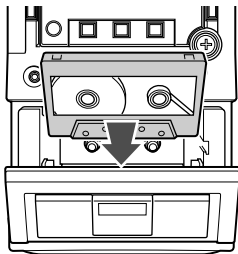

Tape Playback

- 1 Press **TAPE/REV.MODE**.

The unit automatically turns on.

REV. MODE



- 2 Press **II/◀** or **▶/II** to select the playback direction.

Playback starts.

“PLAY” appears on the display and the playback direction indicator moves to show the tape direction.

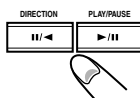

- 3 To stop playback, press **■**.

STOP/CLEAR



To interrupt playback

Press the last selected **II/◀** or **▶/II**.

“PAUSE” appears on the display.

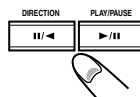

- If you press the button opposite to the last selected direction, playback starts in the reverse direction.

To resume playback, press **II/◀** or **▶/II** again.

Auto Reverse

Press **TAPE/REV.MODE** repeatedly to select the desired playback mode.

◄: playback on one side of the tape only.

◄◄: both sides are played once.

◄◄◄: both sides are played repeatedly up to 10 times unless you press **■**.

REV. MODE



Rewind/Fast Forward

- 1 Press **◀◀** or **▶▶** to rewind or fast forward the tape.

“TAPE” appears and the playback direction indicator blinks on the display.

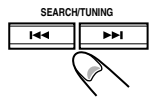

- 2 Press **■** to stop rewinding or fast forwarding.

STOP/CLEAR



- The tape stops automatically at the end of the rewinding or fast forwarding.

Recording

IMPORTANT:

- It may be unlawful to record or play back copyrighted material without the consent of the copyright owner.
- The recording level is automatically set correctly, so it is not affected by the volume control. Thus, during recording you can adjust the sound you are actually listening to without affecting the recording level.
- While recording, you can hear sound modes and/or the BBS sound effect through the speakers. However, the sound is recorded without these effects (see page 9).
- If recordings you have made have excessive noise or static, the unit may be too close to a TV. Increase the distance between the TV and the unit.
- Use only type I normal tapes for recording.
- The use of tapes longer than 120 minutes is not recommended, since characteristic deterioration may occur and these tapes easily jam in the pinch-rollers and the capstans.

To protect your recording

Cassettes have two small tabs on the back to prevent unexpected erasure or re-recording.

To protect your recording, remove these tabs.

To re-record on a protected tape, cover the holes with adhesive tape.

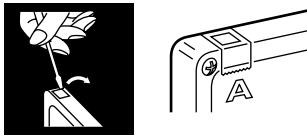

Recording Tapes

1 Load a recordable tape into the tape deck.

2 Press TAPE/REV.MODE repeatedly to either record one side or both sides of the tape.



- ⏮: recording on one side only
- ⏮⏮: recording on both sides

- When you select ⏮⏮, make sure that there is no content that should not be lost is recorded on either side of the tape.

3 Press CD/SHUFFLE or TUNER/BAND to select the recording source.

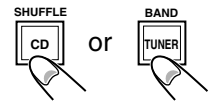

4 Prepare the source.

• For synchronous recording of a CD

Load the disc (see page 12).

- To start recording from the desired track, select the track by pressing ⏮⏮ or ⏭⏭ repeatedly in stop mode.
- To start recording from the desired point on a disc, play the disc and pause at the desired point by pressing ⏭/⏮.

• For recording from the radio

Tune in the desired station (see page 10).

5 Press REC.

“REC” appears, and the recording direction and REC. indicators start blinking.

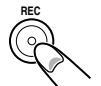

6 While the indicators are blinking, press ⏭/⏮ or ⏭/⏮ to select the recording direction.

Recording starts.

The REC. indicator lights up steadily on the display.

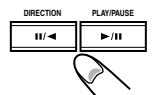

To stop recording, press ■.

The selected recording source continues playing.

- During recording, it is not possible to pause, change the tape direction or listen to another source. “REC ON” appears on the display.
- Recording continues to the end of the tape until you press ■ even after playback of the CD has finished.

Using the beat-cut function

When recording an AM broadcast, beats may occur. If this happens, press BEAT CUT/KEY on the remote control to select the better beat-cut position, “BEAT 01” or “BEAT 02.”

Karaoke

Microphone Mixing

Microphone mixing is available in CD/VCD mode. Connecting a microphone (not supplied) to the unit allows you to sing along with the music source.

- 1 **Connect a microphone to the MIC jack.**
- 2 **Start playing a CD or VCD.**
 - See “Playing Back a Disc” on page 13.
- 3 **Press FM MODE/VOCAL repeatedly to select the desired audio channel.**
 - See “Audio Channel Selection” below.
- 4 **Adjust the microphone mixing level and echo level.**
 - See “MIC volume and echo” on the right.
- 5 **Adjust the key tone level.**
 - See “Key” on the right.
- 6 **Start singing or talking through the microphone.**
 - Keep the microphone away from the speakers to prevent howling.



Karaoke recording

In microphone mixing mode, it is possible to record your voice mixed with the sound of the selected channel on the CD/VCD.

Audio Channel Selection

This feature allows you to fade out the original vocal from a Karaoke VCD. By selecting the audio left/right channel, you can also switch the language on a bilingual VCD, etc.

Press FM MODE/VOCAL repeatedly to select the desired audio channel.

When playing a CD, each press changes the audio channel selection as follows:

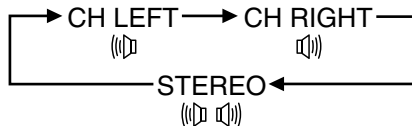

When playing a VCD, each press changes the audio channel selection as follows:

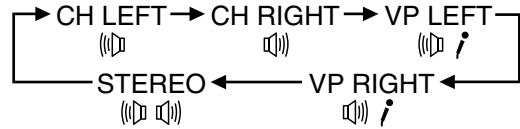

STEREO: same effect as the original recorded disc
 VP LEFT/RIGHT: fades out the original vocal recorded on the left or right channel of a Karaoke VCD when a microphone is connected.

CH LEFT/RIGHT: source sound of the selected channel (left or right) is heard from both speakers while sound of the other channel is muted.

MIC Volume and Echo

This feature allows you to adjust the microphone mixing level and add an echo effect while singing or talking through the microphone.

Adjusting the microphone volume

- 1 Press MIC/ECHO on the remote control. The current microphone volume level appears on the display.



- Each time you enter CD/VCD mode or open/close the disc compartment, the volume level returns to “MIC MIN” (minimum).

- 2 Press VOLUME + or VOLUME – to increase or decrease the MIC volume level.



Adjusting the echo level

- 1 Press MIC/ECHO on the remote control twice. The current echo level appears on the display.



- Each time you enter CD/VCD mode or open/close the disc compartment, the echo level returns to “ECHO MIN” (minimum).

- 2 Press VOLUME + or VOLUME – to increase or decrease the echo level.



Key

This feature allows you to adjust the key tone to your vocal range.

- 1 **Press BEAT CUT/KEY on the remote control.**

“TONE” appears on the display.



- 2 **Press VOLUME + or VOLUME – to adjust the key tone.**

The key tone level can be adjusted between “+15” and “–15”.



- Press BEAT CUT/KEY again to change the tone level to “0”.

There are three timers available — daily timer, recording timer and sleep timer.

Before using the timers, you need to set the built-in clock. (See page 8.)

Using Daily Timer

With the daily timer, you can wake to your favorite music or radio program.

How the daily timer actually works

At the timer-on time, the unit automatically turns on, sets the volume to the preset level, and starts playing the specified source (radio or CD). During play, the TIMER “ON” indicator flashes. Then, at the timer-off time, the unit automatically turns off (on standby).

The timer setting remains in memory until you change it.

- There is a time limit in doing the following steps. If the setting is canceled before you finish, start from step 1 again.

- 1 Press and hold TIMER ON/OFF SET (or TIMER on the remote control) until the TIMER indicator lights up and a source name appears on the display.**

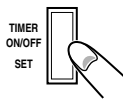

- At this point you can view the previous setting by pressing **◀◀** or **▶▶** repeatedly.

- 2 Press PROGRAM.**

“TUNER,” “TAPE,” “CD” or “REC TU” starts blinking.



- 3 Press ◀◀ or ▶▶ to select the desired source, then press PROGRAM.**

If “TUNER” or “REC TU” is selected, press TUNER to select the current radio station or press **◀◀** or **▶▶** to select a desired preset radio station, then press PROGRAM to confirm the selection. “VOL” appears and the volume level start blinking.

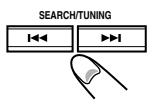

- 4 Press ◀◀ or ▶▶ to set the volume, then press PROGRAM.**

The ON indicator and the hour indication start blinking.

- 5 Press ◀◀ or ▶▶ to set the timer start hour, then press PROGRAM.**

- 6 Press ◀◀ or ▶▶ to set the minute, then press PROGRAM.**

The OFF indicator and the hour indication start blinking.

- 7 Set the time to stop playback following the same procedure as steps 5 and 6.**

“TIMER OK” appears on the display briefly and the timer is now set.

- 8 Press TIMER ON/OFF SET (or TIMER on the remote control) to activate the timer.**

The TIMER indicator lights up.

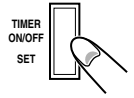

- 9 Turn off the unit (on standby).**

When the preset time is reached, the selected source is played if the timer has been activated.



To deactivate the timer, press TIMER ON/OFF SET (or TIMER on the remote control).

The TIMER indicator disappears.



- The timer-off function is not activated if the starting and stopping times are the same.
- If the selected source (CD or TAPE) is not available when the preset time is reached, TUNER is selected automatically.

Timer Recording

You can use the recording timer to record a preset radio station from a specified time and for a specified duration automatically.

- 1 Load a recordable tape into the tape deck.**

- If desired, select the tape reverse mode option.

- 2 Follow the “Using Daily Timer” procedure on the left. Select “REC TU” as the source for timer recording.**



- If the preset time is reached while the unit is on, the timer is not activated for timer recording.
- The recording timer is canceled once the recording is finished.

Using Sleep Timer

With the sleep timer, you can fall asleep to music. You can set the sleep timer using the remote control when the unit is turned on.

How the sleep timer actually works

The unit automatically turns off after the specified time length passes.

- 1 **Press and hold DISPLAY until “SLEEP OFF” appears on the display.**

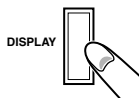

- 2 **Press DISPLAY repeatedly to select the desired time length.**

The SLEEP indicator starts blinking.

Each time you press the button, the time length (in minutes) changes as follows:

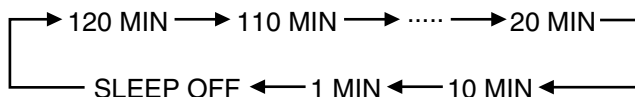

- 3 **Wait for a few seconds after specifying the time length.**

The SLEEP indicator lights up steadily on the display.

To check the time remaining until the shut-off time, press and hold DISPLAY once so that the time remaining until the shut-off time appears for several seconds.

To change the sleep-off time, repeat steps 1 to 3 above.

To cancel the sleep timer, repeat steps 1 to 3 above to specify “SLEEP OFF.”

The SLEEP indicator goes off.

- The sleep timer is also canceled when you turn off the unit.



Setting both the timer-off and sleep-off times causes the unit to enter standby mode when the earlier one of them is reached.

Maintenance

To get the best performance of the unit, keep your discs, tapes, and mechanism clean.

Handling discs



- Remove the disc from its case by holding it at the edge while pressing the center hole lightly.
- Do not touch the shiny surface of the disc, or bend the disc.
- Put the disc back in its case after use to prevent warping.

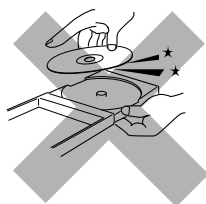

- Be careful not to scratch the surface of the disc when placing it back in its case.
- Avoid exposure to direct sunlight, temperature extremes, and moisture.



To clean the disc

Wipe the disc with a soft cloth in a straight line from center to edge.



DO NOT use any solvent — such as conventional record cleaner, spray, thinner, or benzine — to clean the disc.

Handling cassette tapes

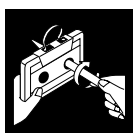

- If the tape is loose in its cassette, take up the slack by inserting a pencil in one of the reels and rotating.
- If the tape is loose, it may get stretched, cut, or caught in the cassette.



- Be careful not to touch the tape surface.



- Avoid the following places to store the tape:
 - In dusty places
 - In direct sunlight or heat
 - In moist areas
 - Near a magnet

Cassette decks

If the heads, capstans, and pinch rollers of the cassette deck become dirty, the following will occur:

- Impaired sound quality
- Discontinuous sound
- Fading
- Incomplete erasure
- Difficulty in recording

To clean the head, capstans, and pinch rollers

Use a cotton swab moistened with alcohol.

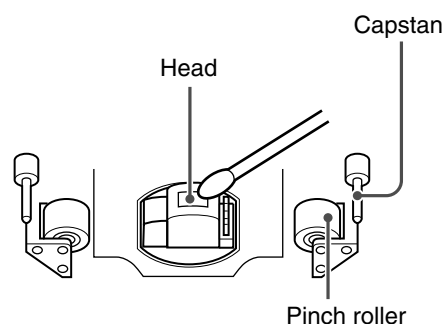

To demagnetize the head

Turn off the unit, and use a head demagnetizer (available at electronics and record shops).

Cleaning the unit

• Stains on the unit

- Should be wiped off with a soft cloth. If the unit is heavily stained, wipe it with a cloth soaked in water diluted neutral detergent and wrung well, then wipe clean with a dry cloth.
- **Since the unit may deteriorate in quality, become damaged or get its paint peeled off, be careful about the followings.**
 - DO NOT wipe it with a hand cloth
 - DO NOT wipe it strong
 - DO NOT wipe it with thinner or benzine.
 - DO NOT apply any volatile substance such as insecticides to it.
 - DO NOT allow any rubber or plastic to remain in contact with it for a long time.

Troubleshooting

If you are having a problem with your unit, check this list for a possible solution before calling for service.

If you cannot solve the problem from the hints given here, or the unit has been physically damaged, call a qualified person, such as your dealer, for service.

Symptom	Cause	Action
No sound is heard.	Connections are incorrect or loose.	Check all connections and make corrections. (See pages 6, 7.)
Power cannot be turned on.	The power cord is unplugged.	Connect the power cord.
The disc does not play.	<ul style="list-style-type: none"> The disc is placed upside down. The moisture has been condensed on the lens. The disc format is not supported on the unit. 	<ul style="list-style-type: none"> Place the disc with the label side up. Wait until the moisture condensation at the lens has cleared. Use a disc recorded in the correct format.
The disc sound is discontinuous.	The disc is scratched or dirty.	Clean or replace the disc. (See page 22.)
No picture is displayed on TV screen.	The unit is not connected to the TV set or the connection is loose.	Connect the cable between the unit and TV set correctly.
No color is shown on TV screen.	The unit is not switched to the PAL or NTSC setting corresponding to the TV set.	Change the PAL/NTSC setting of the unit.
Hard to listen to broadcasts because of noise.	Antenna orientation is not correct.	Readjust the antenna. (See page 7.)
Tape playback sound is at a very low level.	The heads are dirty.	Clean the heads. (See page 22.)
Impossible to record on a tape.	Small tabs on the back of the cassette are removed.	Cover the holes with adhesive tape.
Timer operation does not start.	The current time is not set correctly.	Set the built-in clock correctly.
Unable to operate the unit with the remote control.	<ul style="list-style-type: none"> The path between the remote control and the remote sensor on the unit is blocked. The batteries are exhausted. 	<ul style="list-style-type: none"> Remove the obstruction. Replace the batteries.
The MP3-CD does not play.	The disc is not finalized.	Use a finalized MP3-CD.

Specifications

Amplifier

Output Power

32 W (16 W + 16 W) at 8 Ω (MAX.)

24 W (12 W + 12 W) at 8 Ω (10 % THD)

Audio input sensitivity/Impedance (at 1 kHz)

MIC: 5 mV/48 kΩ

Speakers/Impedance 8 Ω - 16 Ω

Tuner

FM tuning range 87.50 MHz - 108.00 MHz

AM tuning range

At 9kHz intervals: 531 kHz - 1 602 kHz

At 10kHz intervals: 530 kHz - 1 710 kHz

CD player

Dynamic range 60 dB

Signal-to-noise ratio 60 dB

Wow and flutter Unmeasurable

Cassette deck

Frequency response

Normal (type I): 50 Hz - 14 000 Hz

Wow and flutter 0.4 % (WRMS)

General

Power requirement

AC 110 V - 127 V/220 V - 240 V ~ adjustable with the voltage selector, 50 Hz/60 Hz

Power consumption 35 W (operation mode)

4.5 W (standby mode)

Dimensions Approx. 160 mm × 269.5 mm × 300 mm (W/H/D)

Mass Approx. 5 kg

Speaker

Speaker unit Woofer: 10.2 cm cone × 1

Tweeter: 5.1 cm cone × 1

Impedance 8 Ω

Dimensions Approx. 160 mm × 269.5 mm × 192 mm (W/H/D)

Mass Approx. 2 kg/each

Supplied Accessories

See page 6.

Design and specifications are subject to change without notice.

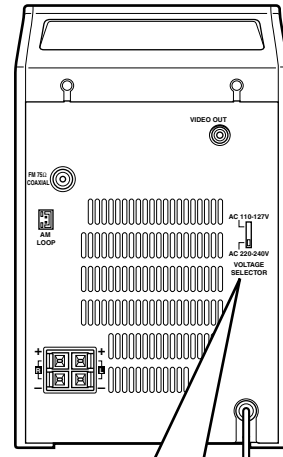

IMPORTANT for mains (AC) line

BEFORE PLUGGING IN, do check that your mains (AC) line voltage corresponds with the position of the voltage selector switch provided on the outside of this equipment and, if different, reset the voltage selector switch, to prevent from a damage or risk of fire/electric shock.

有关主 (AC) 电源线路的重要事项

接插电源以前，务请检查当地的主 (AC) 电源线路电压是否和位于本机外面的电压选择开关设定的位置一致。如果不一致，即重新设定电压选择开关使符合当地电压，以免损坏机器或引起火灾/触电的危险。

AC 110-127V



AC 220-240V

**VOLTAGE
SELECTOR**

JVC
VICTOR COMPANY OF JAPAN, LIMITED