

Palsonic

- 3415DVD**
- 34cm TV / DVD Combination**

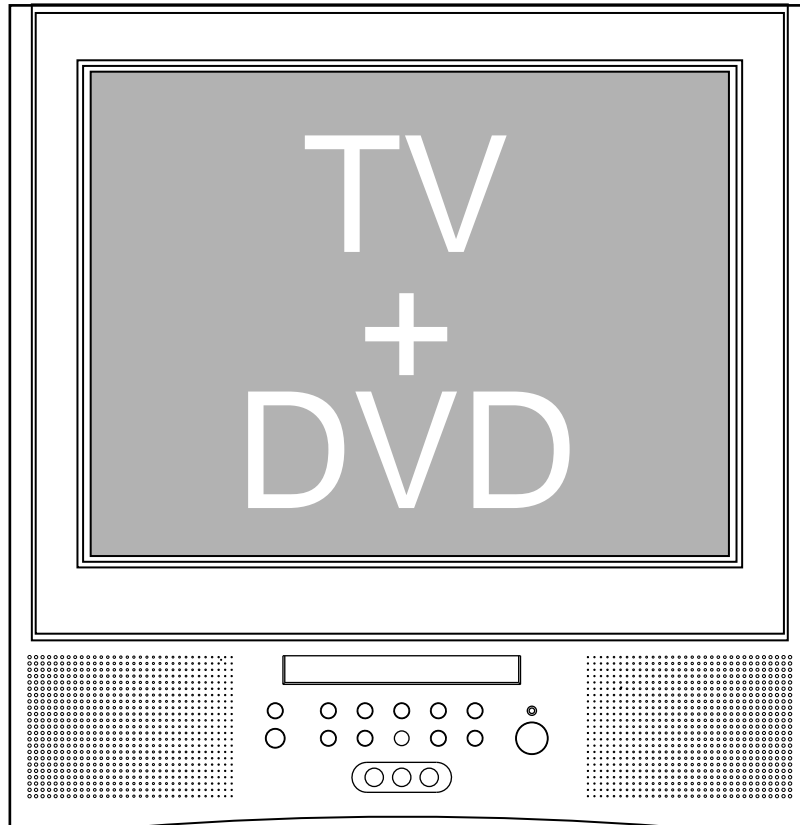

Please read this manual carefully before using this TV set and keep it for future reference.

PALSONIC CORPORATION PTY LTD
1 JOYNTON AVENUE
WATERLOO NSW 2017 AUSTRALIA
TEL: (02) 9313 7111
FAX: (02) 9313 7555
www.palsonic.com.au

PALSONIC CUSTOMER SERVICE
TELEPHONE
AUSTRALIA: 1300 657 888

CONTENTS

Before Operation	
Safety and precautions	2
Installation	3
Aerial Connections	3
Preparation of the remote control	3
Function buttons and external sockets	4
Front panel of the TV set	4
Rear panel of the TV set	4
Using the remote control	5
Basic operation	
Switching the TV set on/off	6
Watching TV	7
Watching TV program	7
Program swap and auto scan functions	7
Searching channels	8
Full automatic mode	9
Semi-automatic search	10
Manual fine tune	11
Program skip	12
Convenient picture and sound control functions	13
Multiple picture modes	13
Black stretch and noise reduce	14
Mute and Fade	15
Time functions	16
Clock setting and timer on/off functions	16
Sleep timer and program preset	17
Setup function	18
Screen saver and Calender	18
AVL	19
Organise function	20
Setting the clock	21
DVD Operation	
Basic Playback	23
Advanced Playback	24
Special Function Playback - JPEG	25
DVD System Setup	26
Playable Discs	29
Disc Protection and DVD Characteristics	30
Others	
Connection to the external audio and video equipment	31
Trouble shooting guide	33
Specifications	33

Safety and Precautions

To ensure safe and reliable operation of the TV set, please observe the following precautions, operation and maintenance.

Attention:

1. Pay attention to the power supply cord before installing the TV set. Do not hang anything on the cord, and avoid treading on the cord.
2. The slots on the housing are designed for ventilation to ensure reliable operation of the TV set and prevent overheating. They must never be blocked. The TV set must not be placed near a heat source or it might be damaged.
3. The outdoor antenna must not be erected close to HV lines or other power supply lines. Use extreme care when erecting the antenna and don't touch live wires or injury may occur.
- 4 This TV set can only use the supply voltage and frequency indicated on the back of the housing. If you power supply does not comply with them, please consult with service personnel.
5. Don not let any object fall into the ventilation openings of the TV set housing, nor let any liquid flow into the machine via the openings
6. Do no not subject the TV set to rain, or use in a damp environment. When cleaning dust, be sure to remove the power supply plug from the socket first. Don not clean the housing directly with liquid detergent, use a damp cloth. Be sure to remove the power supply plug from its socket and remove the antenna plug during a thunderstorm or when it will not be use for a long time, to avoid components being damaged by lightning.
7. if you use an indoor antenna, do not let it touch any electrical appliance, or normal reception of TV programs mat be affected.

Safety:

1. Do not remove the back of the housing yourself, as high voltage inside the unit are dangerous. If it is necessary to open the back, ask a technician with specialised service experience.
2. Remove the power supply plug from its socket in case of the following conditions, and consult with service personnel.
 - (1) The power cord or plug are damaged or show cracks.
 - (2) Any object has fallen into or liquid flown into TV set.
 - (3) The performance of the TV set has deteriorated significantly or there is damage on the housing.
 - (4) The TV set will not operate normally according to the instruction.
3. Please remove the power supply plug from its socket when the TV set will not be used for a long period of time.

CAUTION:

Use of controls, adjustments or procedures other than those specified herein may result in hazardous radiation exposure.



CAUTION
RISK OF ELECTRIC SHOCK
DO NOT OPEN!



CAUTION: TO REDUCE THE RISK OF ELECTRIC SHOCK, DO NOT REMOVE COVER (OR BACK). NO USER SERVICING PARTS INSIDE. REFER SERVICING TO QUALIFIED SERVICE PERSONNEL.



The lightning flash with arrowhead symbol, within an equilateral triangle, is intended to alert the user to the presence of uninsulated "Dangerous Voltage" within the product's enclosure that may be of sufficient magnitude to constitute a risk of electric shock to persons.



The exclamation point within an equilateral triangle is intended to alert the user to the presence of important operating and maintenance (servicing) instructions in the literature accompanying the appliance.

This appliance has a serial number on the rear panel. Please record the serial number and retain it for your records.
Serial Number

WARNING: TO REDUCE THE RISK OF FIRE OR ELECTRIC SHOCK, DO NOT EXPOSE THIS APPLIANCE TO RAIN OR MOISTURE.

Installation

1. First read carefully the relevant instructions in "Safety and Precaution".
2. place the TV set in a place where there is no direct sunlight on it. Any light reflecting from the screen will cause fatigue of your eyes.
3. Use gentle indirect lighting for comfortable watching. The best distance of watching is 5~7 times the screen height.
4. Keep a space of 10cm or over between the TV set and wall for good ventilation.
5. Never put the TV set in a place with excessive temperature or moisture, to avoid damage or failure of its components.

Automatic demagnetising

A colour TV set is likely to be affected by magnetic fields causing colour distortion. If the TV set is moved while on, turned or affected by a magnetic object nearby, turn off the power and wait for at least 1 hour before you turn it on. That is to ensure that the automatic demagnetising circuit will operate eliminating adverse effects of magnetism on colour purity.

Antenna Connection

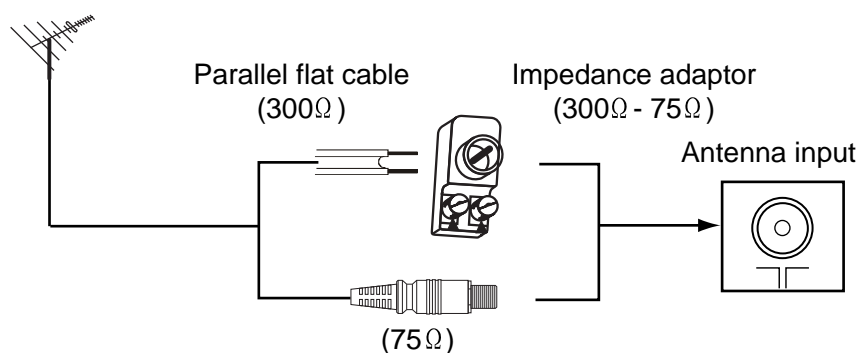

For good reception use an outdoor antenna. The recommended type and location of antenna varies between different areas.

Notes:

1. Connect the outdoor antenna as shown above.
2. It is suggested to use a 75Ω coaxial cable to eliminate interference or noise.
3. The cable must not be tied together with supply cords

Preparing the remote controller

1. Remove the battery cover of remote controller.
2. Load two AA type batteries into the chamber observing the correct polarity.

Precaution operating the remote controller

1. Direct the remote controller to the infrared receiver window of the TV set
2. Do not press the keys on the remote controller continuously.
3. If the remote controller will not be used for long time or if the batteries have depleted, please remove them to prevent leaking.
4. Never throw batteries into fire and properly dispose of the used batteries.
5. Take care not to drop, damp or dismantle the remote controller.

Function Buttons and External Sockets

Front panel of the TV set

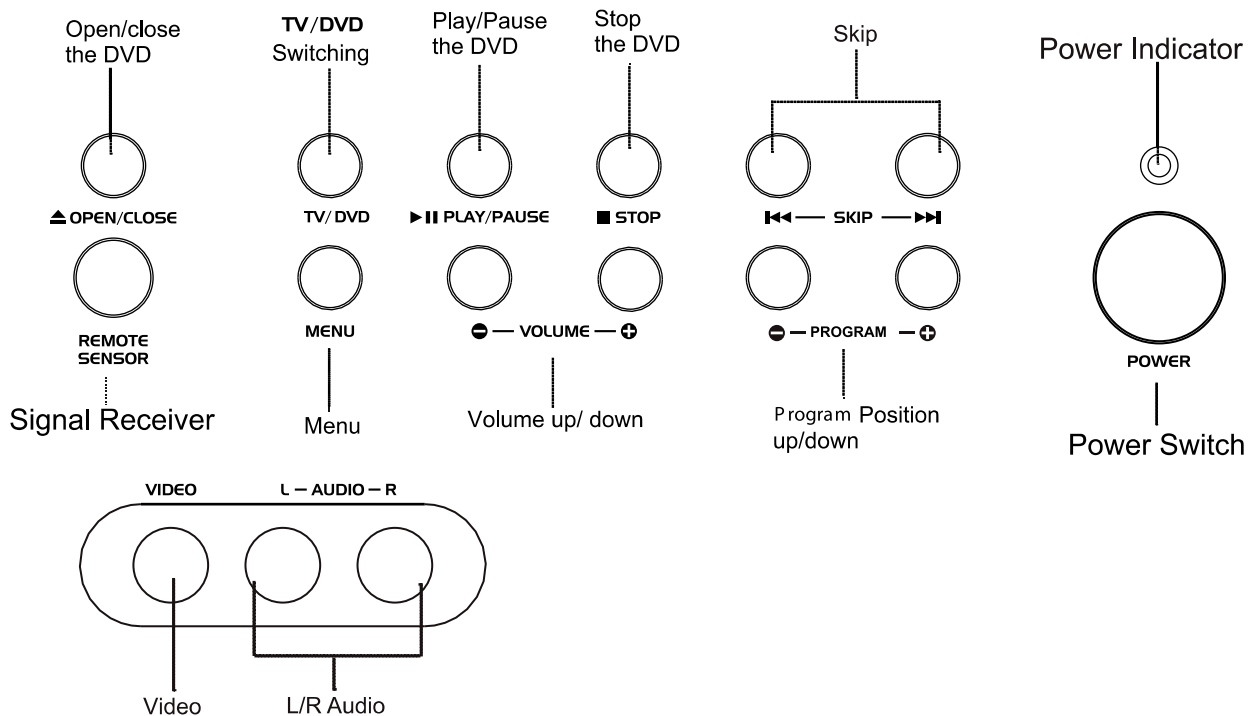

Rear panel of the TV set

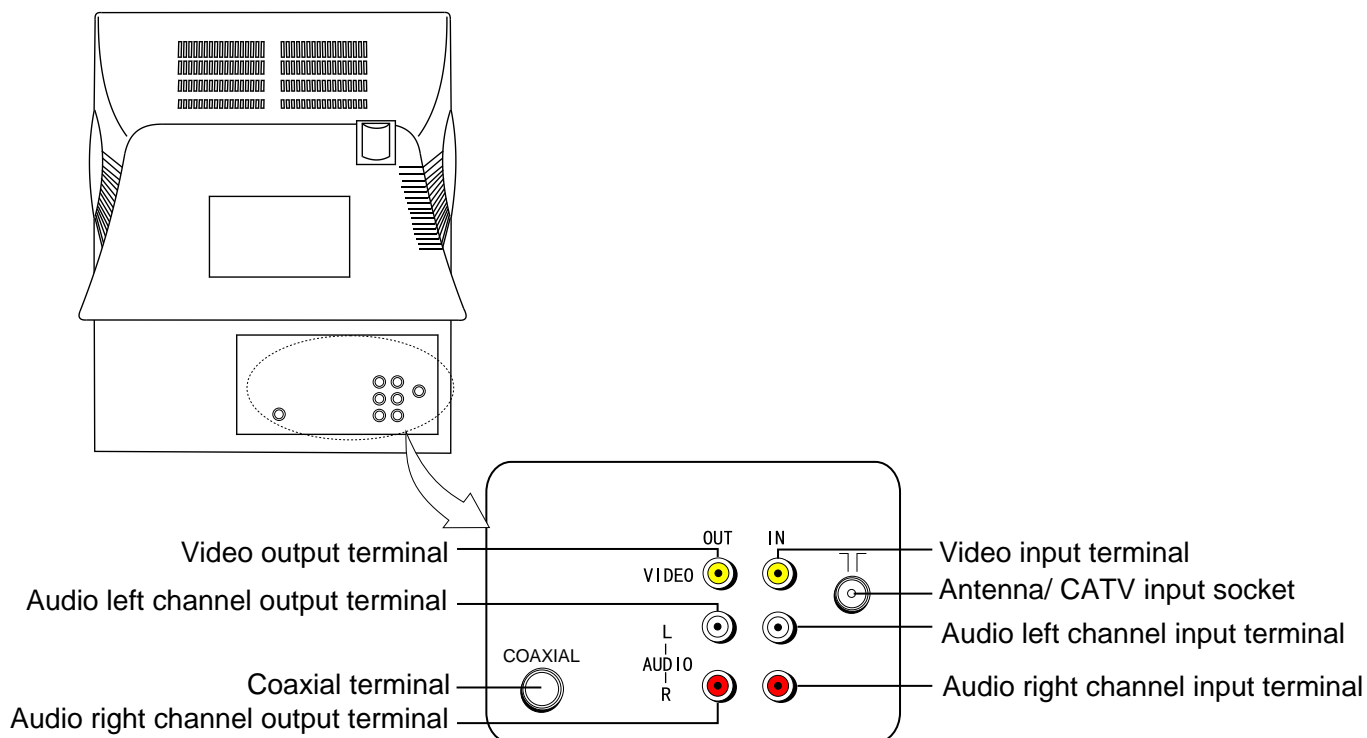

Using the Remote Control

Buttons on the remote control

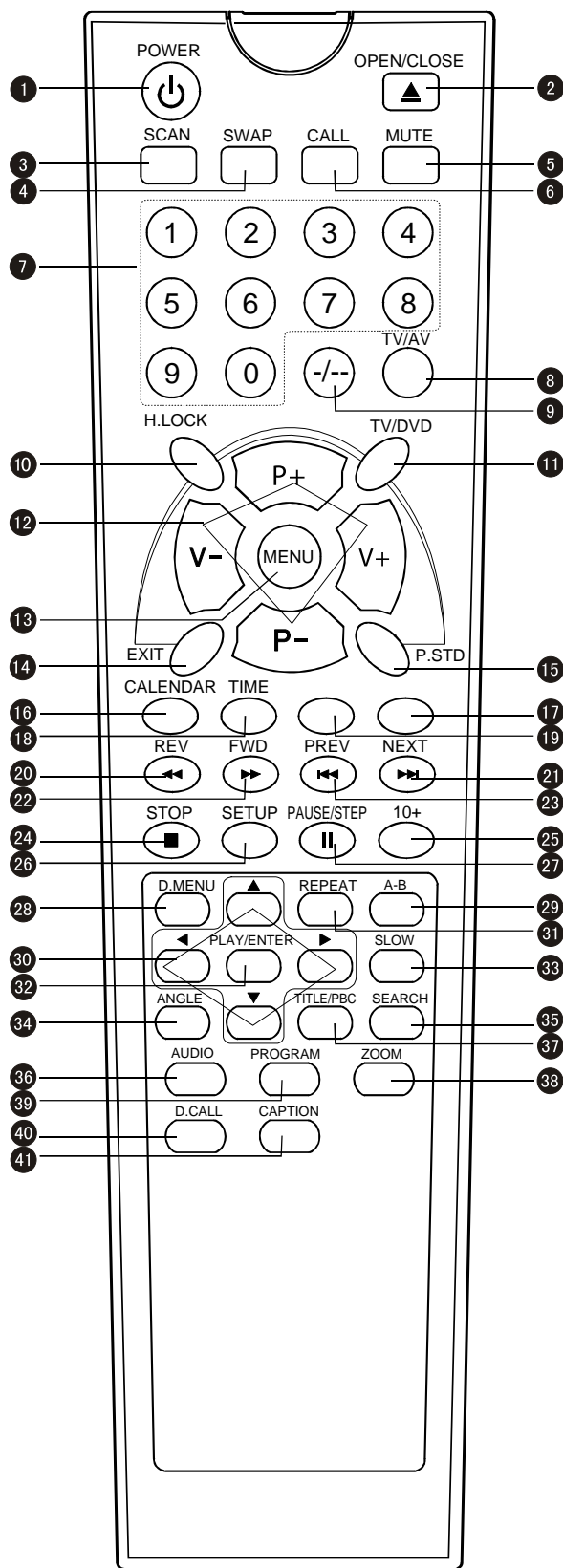

- 1 Stand By
- 2 DVD Open/close
- 3 Scan
- 4 Former Program
- 5 Mute
- 6 Call Screen Display
- 7 Program Number
- 8 TV/AV Exchange
- 9 Digital Selector
- 10 H.LOCK
- 11 TV/AV DVD
- 12 Volume/Channel Selection
- 13 MENU
- 14 Exit Screen Mode
- 15 Picture Mode
- 16 Calendar
- 17 (Not Available)
- 18 Time
- 19 (Not Available)
- 20 DVD PREVIOUS
- 21 DVD NEXT
- 22 DVD FAST FORWARD
- 23 DVD FAST REVERSE
- 24 DVD STOP
- 25 10+
- 26 DVD SETUP
- 27 DVD PAUSE/STEP
- 28 DVD MENU
- 29 DVD A-B REPEAT
- 30 DVD Cursor Move button
- 31 DVD REPEAT
- 32 DVD PLAY/ENTER
- 33 DVD SLOW
- 34 DVD ANGLE
- 35 DVD SEARCH
- 36 DVD AUDIO
- 37 DVD TITLE
- 38 ZOOM
- 39 DVD PROGRAM
- 40 DVD CALL
- 41 DVD CAPTION (SUBTITLE)

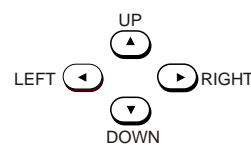

Switching On/Off the TV Set

- This section explains the use of the power button and remote handset to turn your unit on and off.

Switching on/ off the TV set

Switching on/off the TV set

1 Press the Power switch on the The power indicator will light.

2 If the indicator "RED" press the button  on the remote control. Alternatively you can turn the TV on with P+ or P- buttons if the "Child lock is not set.

Note:

1 To turn the sett off to "Standby" press  button on the remote control

4
AUTO
BG

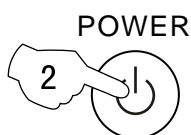

2 To turn off the TV fully, press the Power button and release.

Auto switch-off function

Should the signal input from the aerial be interrupted for more than 5 minutes, the TV will automatically switch to "Standby".

If the TV is in A/V mode or the "background" is set to off (see page18), the set will not switch to standby.

Watching TV

- You can watch a TV program on a channel which has been tuned to a broadcast.

Watching TV programs

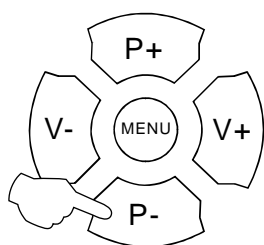
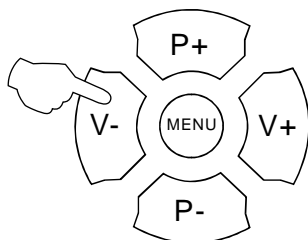
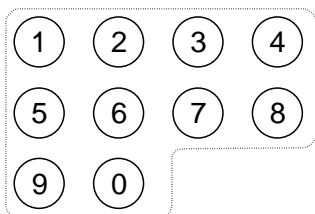

How to select a TV program

Select the desired programs

1 Using number buttons

- Directly enter the channel number with the numeric keypad on the remote control.
- To select channel numbers between 10 ~ 99 press [-/--] button and enter the two digit channel number.
- To select channel numbers between 100 ~ 218 press [-/--] button twice and enter the 3 digit channel number.

2 Using the P+/- buttons

- Press the P+ button to increase channel number.
- Press the P- button to decrease channel number.

Select the desired sound

Press the V-/+ buttons on the remote or the front of the TV set to adjust the volume level. The range is 0~100. When the volume buttons are pressed the volume level is displayed automatically on the TV screen.

How to select the menu

Press the MENU button and the menus will appear at the bottom of the screen. The PIC icon will initially be flashing. Each subsequent press of the menu button will highlight SOU (sound), FUN (function), TUN (tuning) icons respectively.

Press the P-button to display the appropriate menu. Press EXIT to exit.

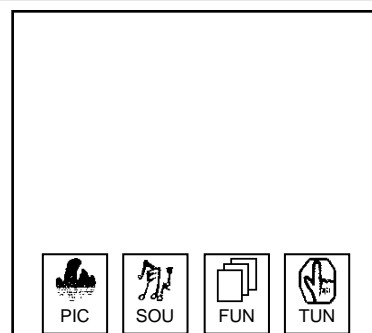

Watching TV (continued)

- Press the SWAP button to select the channel you were watching previously.
- Auto scan function scans through all programs in memory including those with "skip" set to "off" (see "Program skip" on page 12).

Program swap and auto scan functions

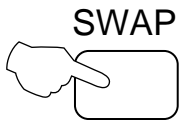

Program swap

Press the SWAP button to select the channel you were watching previously.

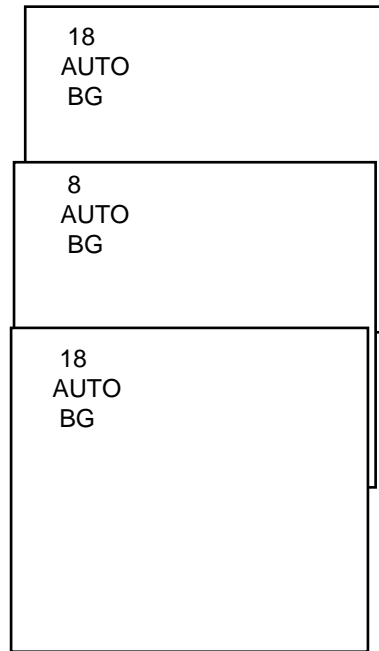

Auto program scan

1 Press the SCAN button to scan through all the memorised TV programs. The scan will pause for a bout 2 seconds on each channel.

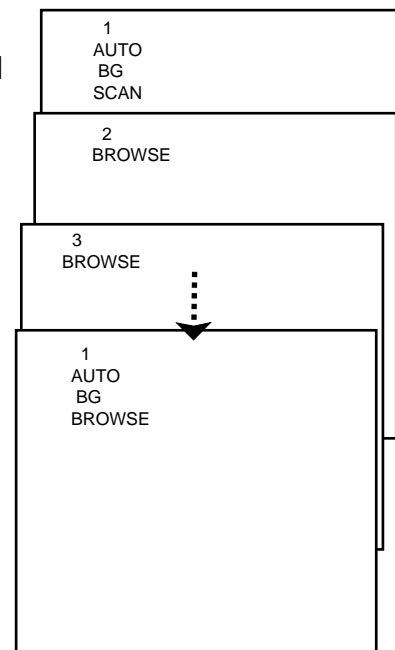

2 If you want to stop the function during auto tuning, simply press the SCAN button again.

Searching Channels

- This TV set has three methods to set the channels, which are respectively full automatic, semi automatic and manual fine tune.
- In this section, how to use the remote control to set the channel is explained. You can also use the buttons on the TV set to set channel.

Full automatic mode

Automatic search

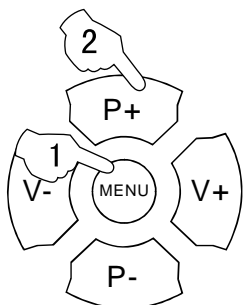

1 Press the **MENU** button. The *MAIN MENU* will appear with the *PIC* (picture) icon flashing. Press the **MENU** button a further 3 times until the *TUN* (tuning) icon is flashing. Press **P-** to enter the *TUNING* menu.



2 Press the **P+/-** buttons to select "AUTO SEARCH".



3 Press the **V+** button to start *AUTO* search. All channels will be stored in the order they are received. After the search has finished, the first channel received will be displayed. Please see page 20 (*Organise*).

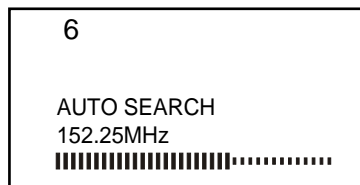
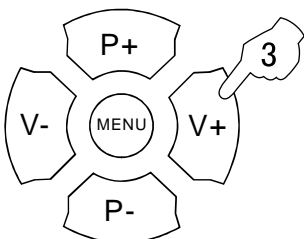

Display function



Press the **CALL** button, then the channel number and the systems will be displayed on the screen.

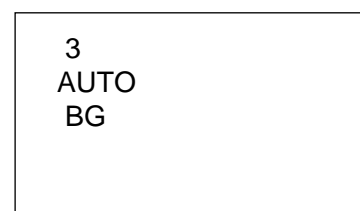

Searching Channels (continued)

Semi-automatic search

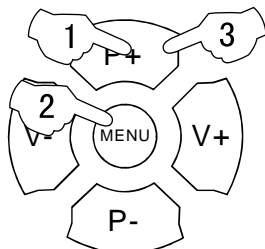

Semi-automatic search

1 Press the P+/- buttons or the PROGRAMME NUMBER (0-9) to choose the desired channel (e.g. Channel 1).



2 Press the **MENU** button. The *MAIN MENU* will appear with the PIC (picture) icon flashing. Press the **MENU** button a further 3 times until the *TUN* (tuning) icon is flashing. Press P- to enter the *TUNING* menu.

3 Press the P+/- buttons to select "SEARCH".

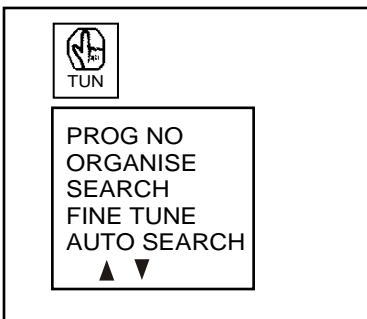

4 Press the V-/ V+ button to start search. Press the V- to search down the scale and the V+ to search up the scale.

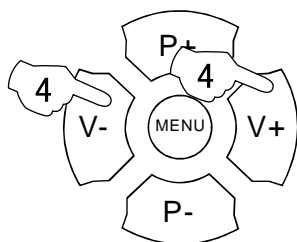
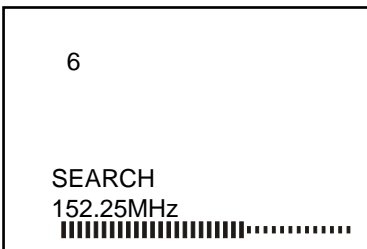

To turn off the on-screen menu

In general, after you press the MENU button, the menu item display (PIC, SOU, FUN, TUN) will automatically disappear within 30 seconds. If you want to eliminate these contents immediately, please press the EXIT button.

Searching Channels (continued)

Programme skip

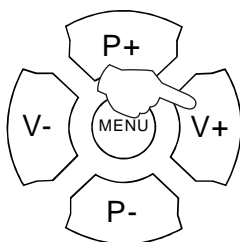
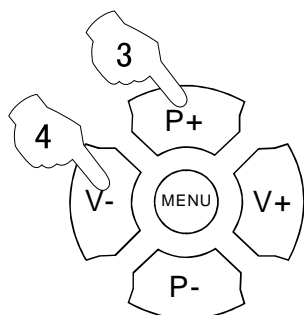
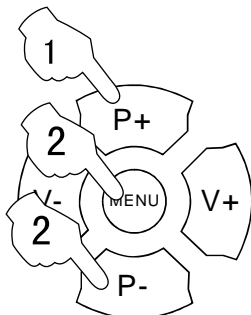

Program skip

Channels can be set so that they are skipped during program selection.

1 Press the P+/- buttons or PROGRAM NUMBER (0-9) button to choose the desired channel (e.g. channel 1).

1
AUTO
BG

2 Press the **MENU** button. The *MAIN MENU* will appear with the *PIC* (picture) icon flashing. Press the **MENU** button a further 3 times until the *TUN* (tuning) icon is flashing. Press **P-** to enter the *TUNING* menu.

3 Press the P+/- buttons to select "SKIP".

4 Press the V-/++ buttons to turn the SKIP function "ON".

5 Press the EXIT button to close the menu. When you use the P+/- buttons to select channel, this channel will be skipped. However, you can still use the PROGRAM NUMBER buttons to select the skipped channel numbers.

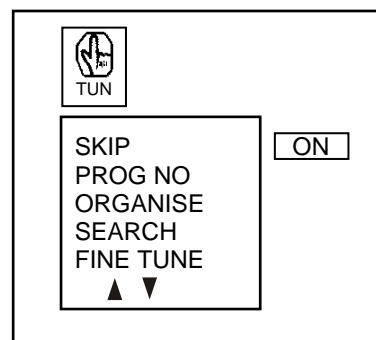

If you want to recover the skipped channel

1 Use the PROGRAM NUMBER buttons to select the channel number to be recovered.

2 Repeat steps 1-3 above.

3 Press the V-/++ buttons to turn the SKIP function "OFF".

Convenient Picture & Sound Control Functions

Multiple picture modes

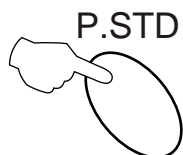

How to select picture modes

You can quickly select the desired picture mode from four preset modes and one customised mode.

Press the P.STD button to select the desired picture quality. Five kinds of picture modes (i.e., "STANDARD", "RICH", "USER", "LISTEN", "SOFT") can be selected in turn.

The 5 modes are

Listen - This is a new feature that blacks out the TV screen when listening to music only channels

Soft - Designed for night time low light viewing;

Standard - Designed for rooms that have good all round lighting;

Rich - Designed for rooms with high ambient lighting such as daytime sport;

User - A spare setting that can be adjusted to personal tastes.

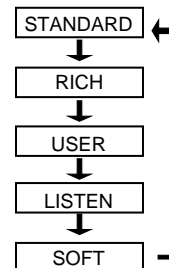

How to customise your own picture status

1 Press the **MENU** button, the *MAIN MENU* will appear with the *PIC* (picture) icon flashing. Press **P-** to enter the *PICTURE* menu.

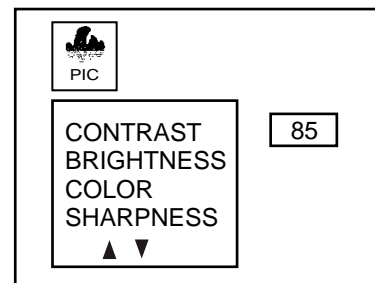
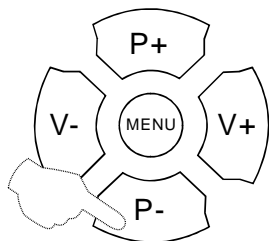

2 Press the P+/- buttons to select the item to adjusted, then press the V-/+ buttons to obtain the desired effect.

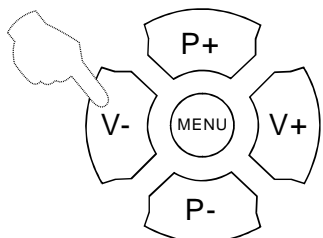

ITEM	Press V -	Press V +
CONTRAST	Weak	Strong
BRIGHTNESS	Dark	Bright
COLOUR	Shallow	Deep
SHARPNESS	Soft	Sharp
*Hue	lean to purple	lean to green

Note: The "Hue" item only appears when the colour system is NTSC.

Convenient Picture & Sound Control Function (continued)

- Black Stretch Automatically increases the contrast range
- Noise Reduce Picture Noise & Grain Reduction Circuit. (Use only on poor reception)

Black stretch and noise reduce

How to select BLACK STRETCH

1 Press the **MENU** button. The *MAIN MENU* will appear with the *PIC* (picture) icon flashing. Press the **MENU** button a further 2 times until the *FUN* (function) icon is flashing. Press **P-** to enter the *FUNCTION* menu.

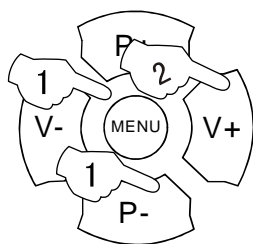
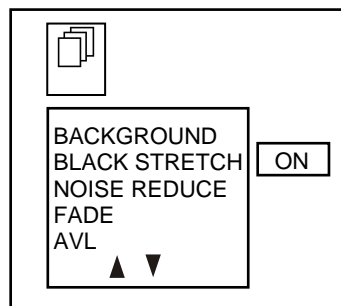

2 Press the **P+/-** button to select "BLACK STRETCH". Press the **V-/+** buttons to turn it "ON" or "OFF".

How to select NOISE REDUCE

1 Press the **MENU** button. The *MAIN MENU* will appear with the *PIC* (picture) icon flashing. Press the **MENU** button a further 2 times until the *FUN* (function) icon is flashing. Press **P-** to enter the *FUNCTION* menu.

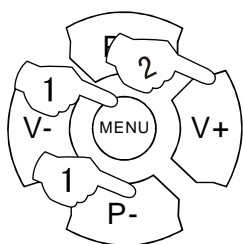
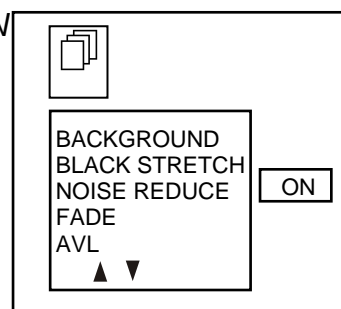

2 Press the **P+/-** buttons to select "NOISE REDUCE". Press the **V-/+** buttons to turn it "ON" or "OFF".

Convenient Picture & Sound Control Functions (continued)

Mute and Fade



Sound mute

1 Press the MUTE button on the remote control to turn off the sound. MUTE will appear on the top left of the display.

MUTE

2 Press MUTE again to turn the sound back on.

Fade

When FADE is turned on, the TV will protect the tube by fading the picture in when the TV is switched on, and fading the picture out when the TV is switched off.

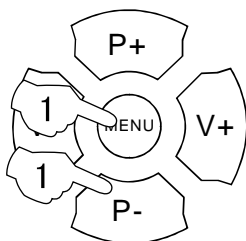

1 Press the **MENU** button. The *MAIN MENU* will appear with the *PIC* (picture) icon flashing. Press the **MENU** button a further 2 times until the **FUN** (function) icon is flashing. Press **P-** to enter the *FUNCTION* menu.

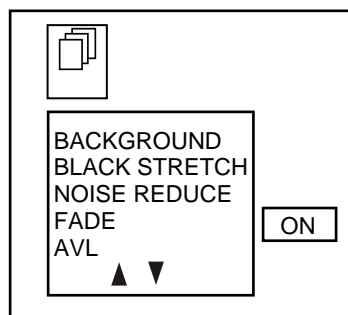

2 Press the P+/- buttons to select FADE.

3 Press the V-/+ button to turn the FADE function "ON" or "OFF".

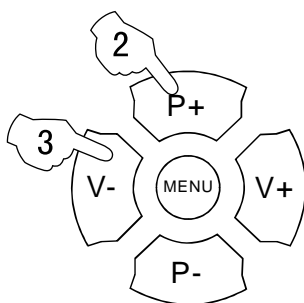

Time Functions

Clock setting and timer on/off functions

Clock setting

The clock will only work if the TV set is left turned on or in standby. When the set is disconnected from the power supply or is turned off by the main power on the front panel, the clock loses power and will need to be reset when the power is reconnected.

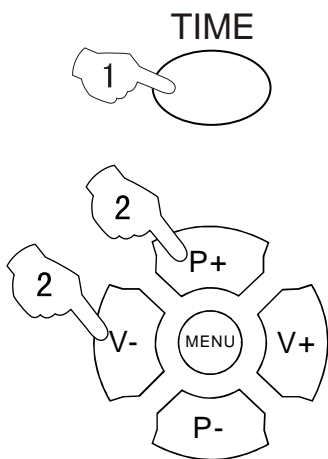

1 Press the TIME button, and the TIME menu appears on the screen.

2 Press the P+/- buttons select "CLOCK", then press the V -/+ buttons to adjust the time in hour position; press again the P+/- buttons to select the time in minute position, then press the V-/+ buttons to adjust the value of minutes.

TIME	
CLOCK	17:18
ON TIME	18:00
ON PROG	1
OFF TIME	--:--
SLEEP TIME	0
REMIND TIME	--:--
REMIND PROG	1

On/off timer

On-off time setting is cleared after timer operates.

Using on/off timer function, the TV set can automatically turn on to a preset program or shut down at a preset time.

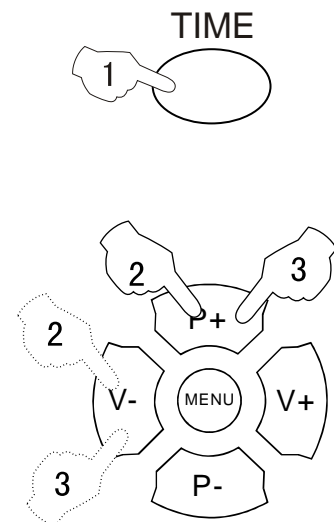

1 Press the TIME button, and the TIME menu display on the screen.

2. Press the P+/- buttons to select "ON TIME", then press the V-/+ buttons to set the value in hour position; press again the P+/- buttons to select the minute position and set the value of the minute (take 18:00 as an example).

TIME	
CLOCK	17:18
ON TIME	18:00
ON PROG	1
OFF TIME	--:--
SLEEP TIME	0
REMIND TIME	--:--
REMIND PROG	1

3 Press the P+/- buttons to select "ON PROG", then press the V-/+ or program number buttons to select your desired channel (take 8 as an example).

4 Repeat step 1-2 to set OFF TIME (take 23:00 as an example).

TIME	
CLOCK	17:18
ON TIME	18:00
ON PROG	8
OFF TIME	23:00
SLEEP TIME	0
REMIND TIME	--:--
REMIND PROG	1

Timer Functions (continued)

Sleep timer and program preset

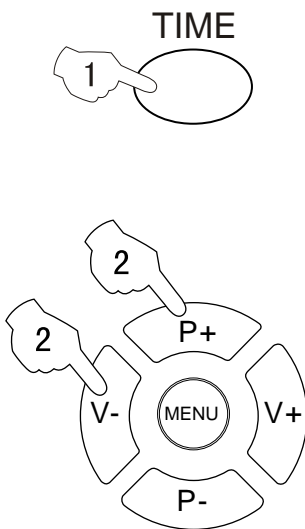

Sleep timer

The sleep timer switches the set to stand-by after the sleep time has elapsed. Sleep time can be set in 10 minute intervals up to 180 minutes, as shown in the illustration. Setting the sleep time to zero turns off the sleep timer.

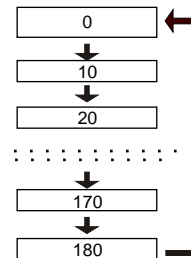

1 Press the TIME button, and the TIME menu appears on the screen.

2 Press the P+/- buttons to select "SLEEP TIMER".

3 Press the V-/+ buttons to set the value of the SLEEP TIMER.

TIME	17:18
CLOCK	18:00
ON TIME	8
ON PROG	23:00
OFF TIME	120
SLEEP TIME	--
REMIND TIME	18
REMIND PROG	

REMIND PROG function

Program remind timer, that can automatically change channel when a program on a different channel is due to start.

1 Press the TIME button, and the TIME menu display on the screen.

2 Press the P+/- buttons to select "REMIND TIME", then press the V-/+ buttons to set the value in hour position; press again the P+/- buttons to select the minute position, and then set the value of the minute (take 19:00 as an example).

3 Press the P+/- buttons to select "REMIND PROG", then press the V-/+ buttons or the program direct number buttons to set the desired channel (take 18 as an example).

NOTE: For REMIND PROG to operate CHILD LOCK must be turned off.

TIME	17:18
CLOCK	18:00
ON TIME	8
ON PROG	23:00
OFF TIME	120
SLEEP TIME	19:00
REMIND TIME	1
REMIND PROG	

TIME	17:18
CLOCK	18:00
ON TIME	8
ON PROG	23:00
OFF TIME	120
SLEEP TIME	19:00
REMIND TIME	18
REMIND PROG	

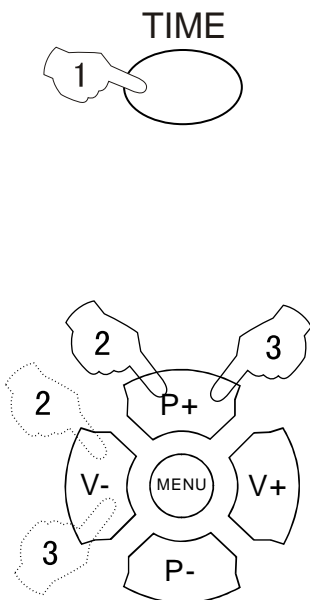

Set Up Functions

Screen saver and Calendar

How to start screen saver function

When the background function is ON a bouncing 'NO SIGNAL' will be displayed on a blue back ground.

NO SIGNAL

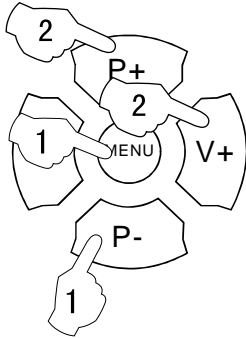

1 Press the **MENU** button. The *MAIN MENU* will appear with the *PIC* (picture) icon flashing. Press the **MENU** button a further 2 times until the *FUN* (function) icon is flashing. Press **P-** to enter the *FUNCTION* menu.

2 Press the P+/- buttons to select **BACKGROUND**. Then press V+/- to turn the **BACKGROUND** function ON or OFF.

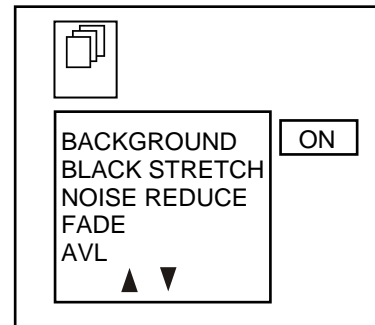

CALENDAR



Calendar function

1 Press the **CALENDAR** button. The calendar menu will be displayed on the screen.

The date on the top line is in Year / Month / Day format.

SOLAR		2001	11	14		
S	M	T	W	T	F	S
				1	2	3
4	5	6	7	8	9	10
11	12	13	14	15	16	17
18	19	20	21	22	23	24
25	26	27	28	29	30	

2 Press the P+/- buttons to highlight the year, month or day number. Press the V-/+ buttons to set or change each number.

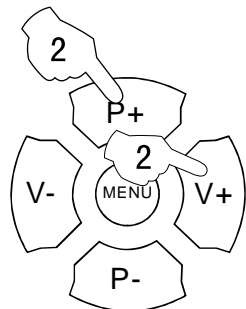

Press EXIT or wait a minute for the calendar to disappear.

Set Up Functions (continued)

AVL

AVL function

Automatic Volume Level control reduces the effect of large volume changes. For instance, when advertisements come on.

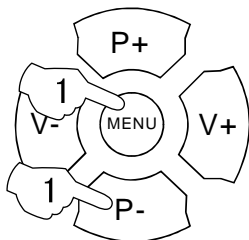

1 Press the **MENU** button. The *MAIN MENU* will appear with the *PIC* (picture) icon flashing. Press the **MENU** button a further 2 times until the *FUN* (function) icon is flashing. Press **P-** to enter the *FUNCTION* menu.

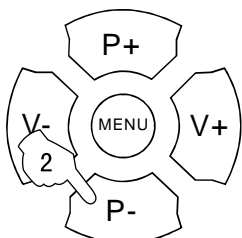
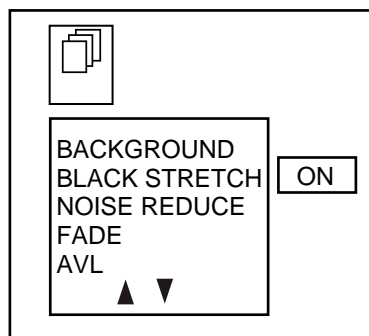

2 Press the **P+/-** button to select "AVL".

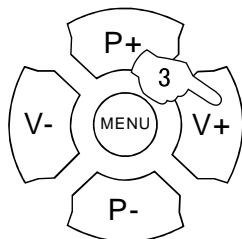
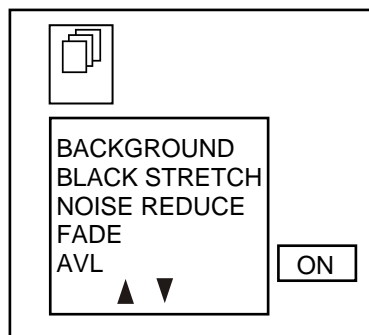

3 Press **V-/++** button to turn the AVL function "ON" or "OFF".

Organise Functions

Organise

ORGANISE

This feature enables TV programmes that may be on a wrong program number to be moved to another number.

This feature is very useful when Automatic Search Tuning has been used because programmes are stored in the order they are found, which is usually not the desired order.

When organising, it is best to start from the lowest programme number first.

1. Press the MENU button. The MAIN MENU will appear with the PIC icon flashing.

Press the MENU button a further 3 times until the TUN icon is flashing. Press P- to enter the TUNING menu.

2. Press P+ or P- buttons to select ORGANISE.

Press V+ to enter the menu.

(For Example) If the Automatic Search function has placed SBS on programme position 6 and you would like to move this so it appears on programme position 1.

3. Use P+ or P- to select "FROM".

4. Press V+ or V- to change the "FORM" programme number to 6.

5. Use P+ or P- to select "TO".

6. Press V+ or V- to change the "TO" programme number to 1.

7. Use P+ or P- to select "MOVE CHANNEL".

8. Use V+ or V- to perform the action.

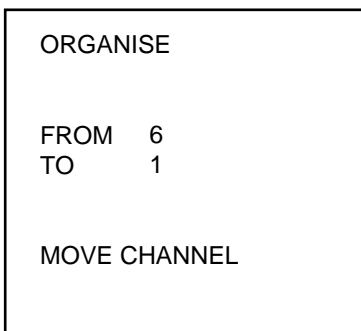
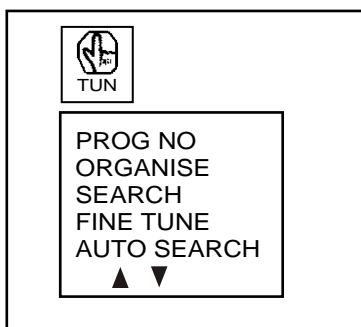

The diagrams below explain how the ORGANISE function affects other channels when position 6 is moved to position 1.

Start Position

Move FROM 6. TO 1

Other programmes move down to allow for space

P 01	Contents	P 01	Contents	Contents	P 01	Contents	↓	←
P 02	Contents	P 02	Contents		P 02	Contents	↓	
P 03	Contents	P 03	Contents		P 03	Contents	↓	
P 04	Contents	P 04	Contents		P 04	Contents	↓	
P 05	Contents	P 05	Contents		P 05	Contents	↓	
P 06	Contents	P 06			P 06	Contents	↓	

What was on programme position 6 is now on programme position 1.
 All the other stored channels have now moved down 1 position so that now.
 What was on programme position 1 is now on programme position 2.
 What was on programme position 2 is now on programme position 3.
 What was on programme position 3 is now on programme position 4.
 What was on programme position 4 is now on programme position 5.
 What was on programme position 5 is now on programme position 6.

Note: It needs some time to move two channels, please wait till the TV finishes the process.

Setting the Lock

- This TV set provides the option of locking various parts of the TV to guard against unauthorised viewing.

Changing your Password

H.LOCK

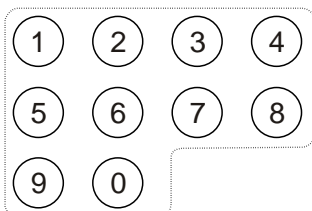
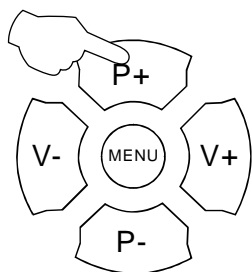

Changing your password

This TV set can set a four digit password, the original one is 0000, if you want to reset it, please follow the instructions below.

1 Press H.LOCK button, the screen will show as the form on the right.

INPUT PASSWORD ----

2 Press the 0 button four times and enter the menu of LOCK setting. Press P+/- button and move the indicator to CHANGE PW., and press V+ button to enter the sub-menu of change password.

LOCK SET	
CHANGE PW.	OFF
TUNING LOCK	OFF
PRESET PROG	1
AV LOCK	OFF
CHILD LOCK	OFF
MAX VOLUME	50
UNLOCK	

3 Press the PROGRAM NUMBER (0-9) button and input a four-digits password.

CHANGE PW.
NEW PASSWORD ----
CONFIRM ----

4 After inputting your new password, please confirm it by keying it in again. You can now enter the lock settings using your new password.

Setting the Lock (continued)

Setting the Lock

H.LOCK

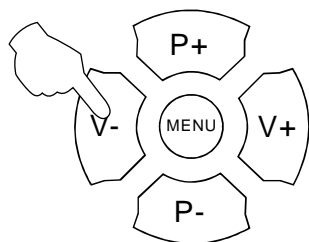
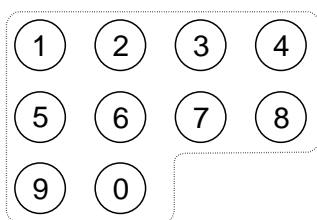
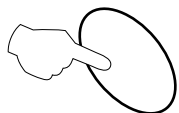

Setting the Lock

There are TUNING LOCK, AV LOCK, and CHILD LOCK, etc, you can set it due to your needs.

1 Press the H.LOCK button, the screen will show as the form on the right.

INPUT PASSWORD

2 Press the PROGRAM NUMBER (0-9) button 0 for four times (or input the password you set), and enter the LOCK menu.

LOCK SET	
CHANGE PW.	
TUNING LOCK	OFF
PRESET PROG	1
AV LOCK	OFF
CHILD LOCK	OFF
MAX VOLUME	50
UNLOCK	

3 Press P+/- button, move the indicator to the lock function you require and press V+ or V- button to set it ON or OFF, change setting or activate it.

Description of each lock function

1. When the TUNING LOCK is set ON, if you want to enter the TUNING menu, you will have to type the password.
2. The PRESET PROG allows the TV to always be on the same channel when you turn it on.
3. When AV LOCK is set ON the AV channel cannot be used, hence the screen will indicate that AV has been locked.
4. When the CHILD LOCK is set ON, if the buttons on the TV are pressed, the screen will indicate that the TV set is in the status of CHILD LOCK, and the buttons won't work.
5. The MAX VOLUME allows you to set a figure for the top limit of volume. Volume control still shows 1~100 but volume level is scaled down.
6. The UNLOCK allows you to set all the lock to OFF and set the MAX VOLUME to 100.
7. If you forget your password or a password is accidentally set enter 9443 as the password. This will enable you to regain control.

Basic Playback

Basic Playback

Preparations

- Press the TV/DVD button on the remote control or the TV to enter the DVD status.

Basic playback

1. Press OPEN/CLOSE to open the disc tray, place a disc on the disc tray.
There are two different disc sizes. Place the disc in the correct guide on the disc tray. If the disc is out of the guide, it may damage the disc and cause the DVD player to malfunction.
 - Do not place a disc which is unplayable in this DVD player.
2. Press OPEN/CLOSE to close the disc tray, the playback will automatically start.
 - Some discs do not start automatically. Press PLAY/ENTER to start playback.
3. Some discs may start playback with a menu. Use the cursor buttons on the remote control to select menu options and press PLAY/ENTER to start. You may also press the digit buttons to select a menu option directly. Many DVDs will not allow this during start-up.

Pause playback

1. Press PAUSE/STEP to pause playback (still mode).
The sound will be muted during still mode.
2. Press PLAY/ENTER to resume normal playback.

Stop playback

1. Press STOP ■ button to go to stop mode, the TV screen will show the start logo. For some discs the player can recall the location where stopped, such as DVDs and audio CDs.
2. Press PLAY/ENTER to resume play-back from the location where playback was stopped.
3. Press STOP twice to stop completely.
Play must then resumed from the title beginning.

Previous and Next

During Playing, pressing the PREV ◀◀ key will restart the current chapter and skip chapters backwards with each subsequent press until the start of the disc is reached.
Each press of NEXT ▶▶ key during playing will skip the current chapter and play the next one. In case of CD audio and photo discs the next track, song or photo is reached.

Fast forward and Fast reverse

1. Press FWD ▶▶ to fast forward through the disc.
Each time the FWD ▶▶ button is pressed, the fast forward motion speed changes.
2. Press PLAY/ENTER to resume normal playback.
3. Press REV ◀◀ to fast reverse through the disc.
Each time the REV ◀◀ button is pressed, the fast reverse motion speed changes.
4. Press PLAY/ENTER to resume normal playback.

Single step playback

To "single step" press the "Pause" button, then press "Pause/Step" in continuous steps to view the next frame.

Advanced Playback

Advanced Playback

IMPORTANT NOTE:

ALL DESCRIBED FUNCTIONS ARE FOR DVD DISCS. IF YOU PLAY OTHER FORMATS THE OPERATION AND DISPLAY ON SCREEN MAY VARY.

SUBTITLE

Press " SUBTITLE ", the screen will display "SUBTITLE 01/XX XXXXX", "01" indicates the ordinal number of this language; "XX" indicates total number of language; "XXXXXX" indicates the language of country. (the number of language depends on disc). This function can select up to 32 languages displayed on screen.

REPEAT

Press " REPEAT " and Chapter repeat will be displayed on screen, the second press will display Title repeat, the third press will display All repeat, the fourth press will cancel this function.

A-B

Press "A-B" to begin start-point, press again to set an end point and complete setting. The selected section A-B will be repeated. The third press will cancel this function.

ANGLE

When enjoying sports, concert or theatre, press this key to watch same actions in different angles. (Valid for discs possessing this function. Using a disc recorded in multi-angle you can view the scene from different angles, for example, front, side, whole view and exterior scene).

D.MENU

Press this key to display root menu, select item according to your preference. (This function will work with a DVD having a multi-layer menu.)

D.CALL

Pressing this key will cycle through "title elapsed", "title remain", "chapter elapsed", "chapter remain" and "display off ". Each displays the appropriate time information.

PROGRAM

When playing discs, press "PROGRAM" to enter program mode. Starting with program number "01" highlighted, press the digit buttons to select the title and chapter number that you want. When finished move the cursor to select "START". This will start the program playback.

SEARCH

Press "SEARCH" once to display Disc Go To --:--, use numeric key to enter the desired time of Disc. Press " SEARCH " twice to display Track Go To --:--, use numeric keys to enter the desired time of track. Press " SEARCH " 3 times to display Select Track --/03, use numeric keys to enter the desired track.

SLOW

Press SLOW to play a disc in slow forward. Each time the SLOW button is pressed, the slow motion speed changes.
Press PLAY/ENTER to resume normal playback;

Note: This function is invalid for CD.

TITLE/PBC

With some DVD discs pressing this key will display the title menu. You can then use the digit buttons to select the item you prefer.

AUDIO

Press this key can change the mode of audio. such as: Audio 1/2: AC 3 2 CH English
Audio 2/2: AC 3 5.1 CH English
Press this button to cycle between Mono Left, Mono Right, Mix-Mono and Stereo.

Note: Do not press this button continuously. Each press must have a 3 second delay.

Special Function Playback

JPEG DISC PLAYBACK

Users can record pictures from digital camera or scanner onto a CD-R or CD-RW disc using a personal computer, CD recording drive and suitable software. Be sure to use good quality recordable discs and trustworthy software with good instructions. Take care with recording settings: the disc must be recorded as data disc ISO9660 format, short file names (8 characters) are best, no multi-session and must be "finalised".

JPEG disc contains pictures in a compact file format which can be decoded by the DVD player and output for viewing and enjoyment on the television screen.

When a disc containing standard JPEG picture files is inserted into the player, a navigation menu will be displayed automatically. Use the UP and DOWN cursor buttons to select a file then press PLAY/ENTER. The slide show will commence. Press PREVIOUS or NEXT to move between pictures. Press pause to stop on the current picture. Press PLAY/ENTER to resume normal playing.

Press D.MENU to go back to folder and file view.

In the navigation menu you can open folders containing files by moving the highlight onto them with the UP and down buttons, then pressing PLAY/ENTER.

Program button changes between folder and file list.
Some repeat functions can be used (see MP3 play).

Zoom functions are not included.

SCREEN SAVER FUNCTION

This unit employs a screen saver mode to help protect the tube during static video pictures. This can be turned off on the GENERAL SETUP PAGE (see Pg. 27)

DVD System Setup

DVD System Setup

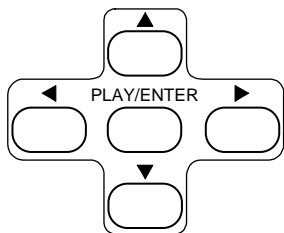
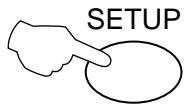

General Setup Process

1. Press the SETUP button, the General Setup Page, Preference Page will be displayed in turn.
2. Press ▲ or ▼ to select the item, then press ► to enter the submenu.
3. Press ▲ or ▼ to setup, then press PLAY/ENTER to confirm.
4. Press EXIT key or press SETUP repeatedly to exit the set-up menus.

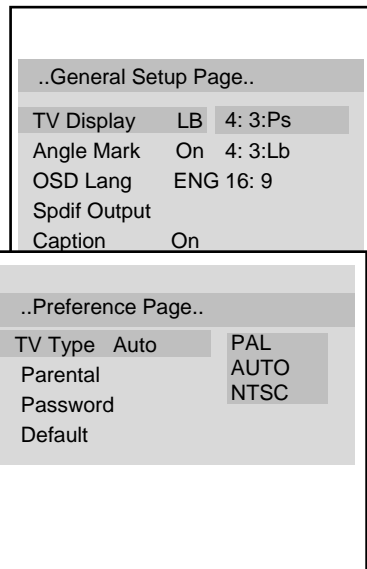

General Setup Page

ASPECT RATIO DESCRIPTION

When using the DVD with the internal TV, select 4:3/LB.

The following information applies only when the DVD output is connected to an external TV.

- 4:3/PS (PS = Pan and Scan)

You may select if you have a normal aspect ratio (4:3) TV, although the 4:3/LB (letter box) is a more common choice. In PS

mode, widescreen material will fill the screen, but at the expense of chopping off extreme left and right edges of the original film picture. For this feature to work, the disc must be specially coded. Such discs are uncommon.

- 4:3/LB (LB = Letter Box)

You may select this if you have a normal aspect ratio (4:3) TV. Widescreen material will be shown in pure unaltered form, allowing the entire picture area of the original film to be viewed without any side cropping. Black bars will appear above and below the picture.

- 16:9

You may select this if you have a widescreen (16:9) TV. Black bars may still appear above and below the picture even if using a widescreen TV. This is because some film directors prefer to use ultra widescreen aspect ratios e.g. 2.35:1. This will normally be indicated on the DVD packaging.

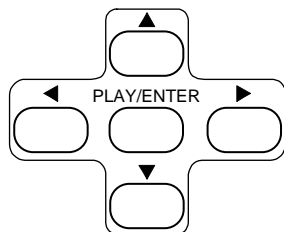
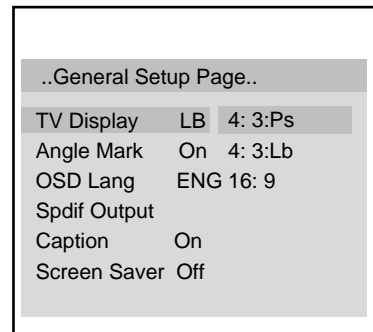

DVD System Setup (continued)

DVD System Setup

General Setup Page

ANGLE MARK: Users can select a particular camera angle when playing a DVD which offers multiple angles.

This item allows you to set Angle Mark ON or OFF.

On Screen Display (OSD) Language: Users can select on-screen display language.

SPDIF OUTPUT MODE: Sets the audio outputs.

This DVD player includes three kinds of audio output:

- SPDIF OFF:** An analog surround sound format is output through the back-panel connections for 2-CH audio out or 5.1 CH audio out.
- SPDIF/RAW or SPDIF/PCM:** This surround sound format is output to a Dolby Digital/DTS decoder through the coaxial connector on the back panel of the product.

CAPTIONS: This function allows you to display or hide the caption.

SCREEN SAVER: If the screen saver is on, then there will be an animated picture of DVD on the screen whenever the DVD player is idle for more than 3 minutes.

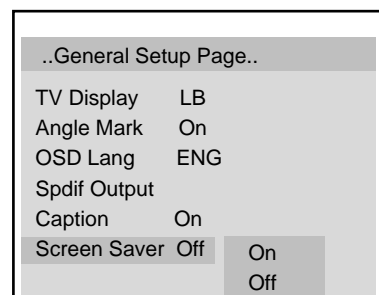
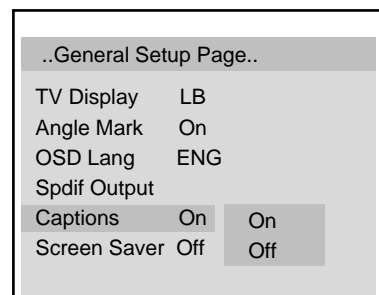
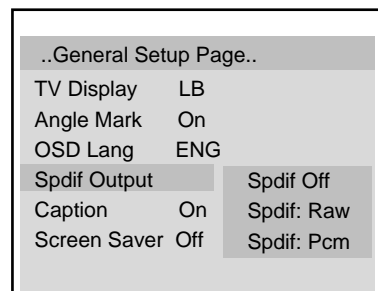
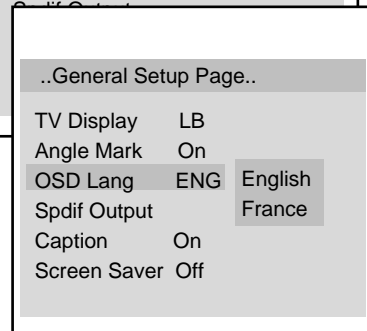
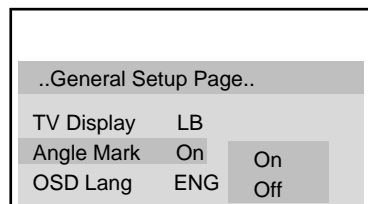

DVD System Setup (continued)

DVD System Setup

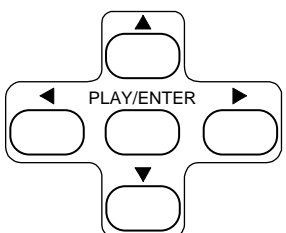
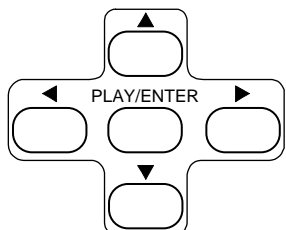

Preference Page

The Preference Page is only available when there is no disc in the player. These settings are applied consistently to all discs which are inserted and played.

TV TYPE: This player supports different TV output, including MULTI (Auto), NTSC, and PAL systems. Usually please set to MULTI.

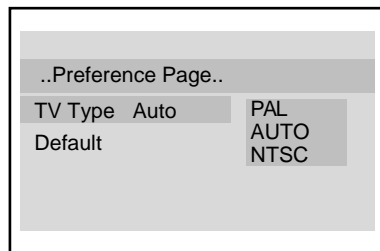

DEFAULT: Resets all settings (except password and parental lock status) for this DVD player back to the manufacturers original settings. Press ENTER to perform the reset.

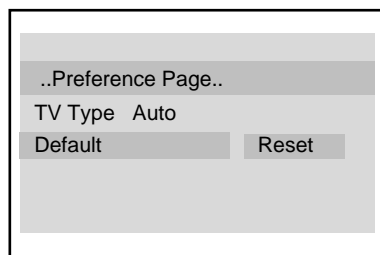





Note:

Some functions may not be available depending on the type of disc.

Playable Discs

The following discs can be played:

DISCS	LABEL	CONTENTS	DIMENSION
DVD VIDEO		Audio +Video (moving picture)	12cm
			8cm
AUDIO CD		Audio	12cm
			8cm
HDCD		Audio	12cm
			8cm
JPEG		Video(picture)	12cm
			8cm
CD-R	CD•R	Audio or Video (moving picture)	12cm
			8cm
CD-RW	CD-RW	Audio or Video (moving picture)	12cm
			8cm
CD+G	CD+G	Audio(picture)	12cm
			8cm

- You cannot play discs other than those listed above.
- You cannot play discs of non-standardized discs, even if they may be labelled as above.
- The performance of CD-R or CD-RW disc is depend on the way the disc is prepared.
- see under "Special function playback - JPEG disc playback".

Disc Protection and DVD Characteristics

ON HANDLING DISCS

- Do not touch the playback side of the disc.
- Do not attach paper or tape to disc.

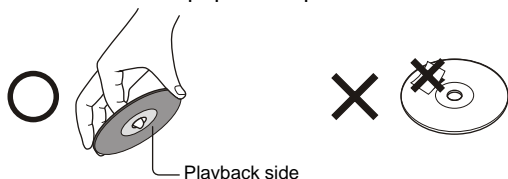

ON STORING DISCS

- Do not store discs in a place subject to direct sunlight or near heat source.
- Do not store discs in place subject to moisture and dust such as bathroom or near humidifier.
- Store discs vertically in a case. Stacking or placing object on discs outside of their case may cause warping.

ON CLEANING DISCS

- Fingerprints and dust on the disc cause picture and sound deterioration. Wipe the disc from the centre outwards with a soft cloth. Always keep the disc clean.



- If you can not wipe off dust with a soft cloth, wipe the disc lightly with a slightly moistened soft cloth and finish with a dry cloth.
- Do not use any type of solvent such as thinner, benzene, commercially available cleaners or anti-static spray for vinyl LPs. It may damage the disc.

STRUCTURE OF DISC CONTENTS

Normally, DVD discs are divided into titles, and the titles are sub-divided into chapters. Audio CD are divided into tracks

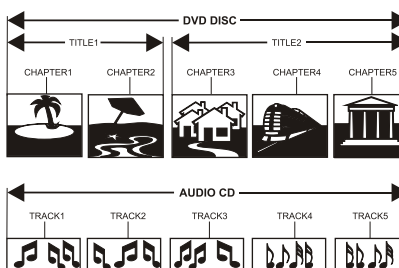

Each title, chapter, or track is assigned a number, which is called title number, chapter number or track number respectively.

There may be discs that do not have these number.

Compare DVD disc with other discs:

	DVD				LD	SVCD	VCD	CD
Encode method	Digital/MPEG II				Analog	Digital	Digital/MPEG I	Digital
Capacity	Single-side single-layer 4.7G	Double-side single-layer 8.5G	Single-side double-layer 9.4G	Double-side double-layer 17G	/	650MB	650MB	650MB
Playing Time	133 minutes	242 minutes	266 minutes	484 minutes		Single-side 60 minutes double-side 120 minutes	45 minutes	74 minutes
Disc diameter	12cm/8cm				30cm/20cm	12cm	12cm	12cm/8cm
Horizontal resolution	More than 500 line				No more than 430 line	No more than 350 line	No more than 250 line	/
Picture proportion	Multiple kinds				One kind	One kind	One kind	
Subtitle	32 kinds				16 kinds at most	4 kinds	/	
Language	8 kinds				4 kinds at most	4 kinds at most		2 kinds
Sound quality	48KHz, 96KHz/ 6, 20, 24bit				44.1KHz/ 16bit	44.1KHz/ 16bit	44.1KHz/ 16bit	44.1KHz/ 16bit

Connecting the TV Set to Other Video & Audio Equipment

Connection of AV input/output terminal

The figure below shows how to connect external equipment using AV signals.

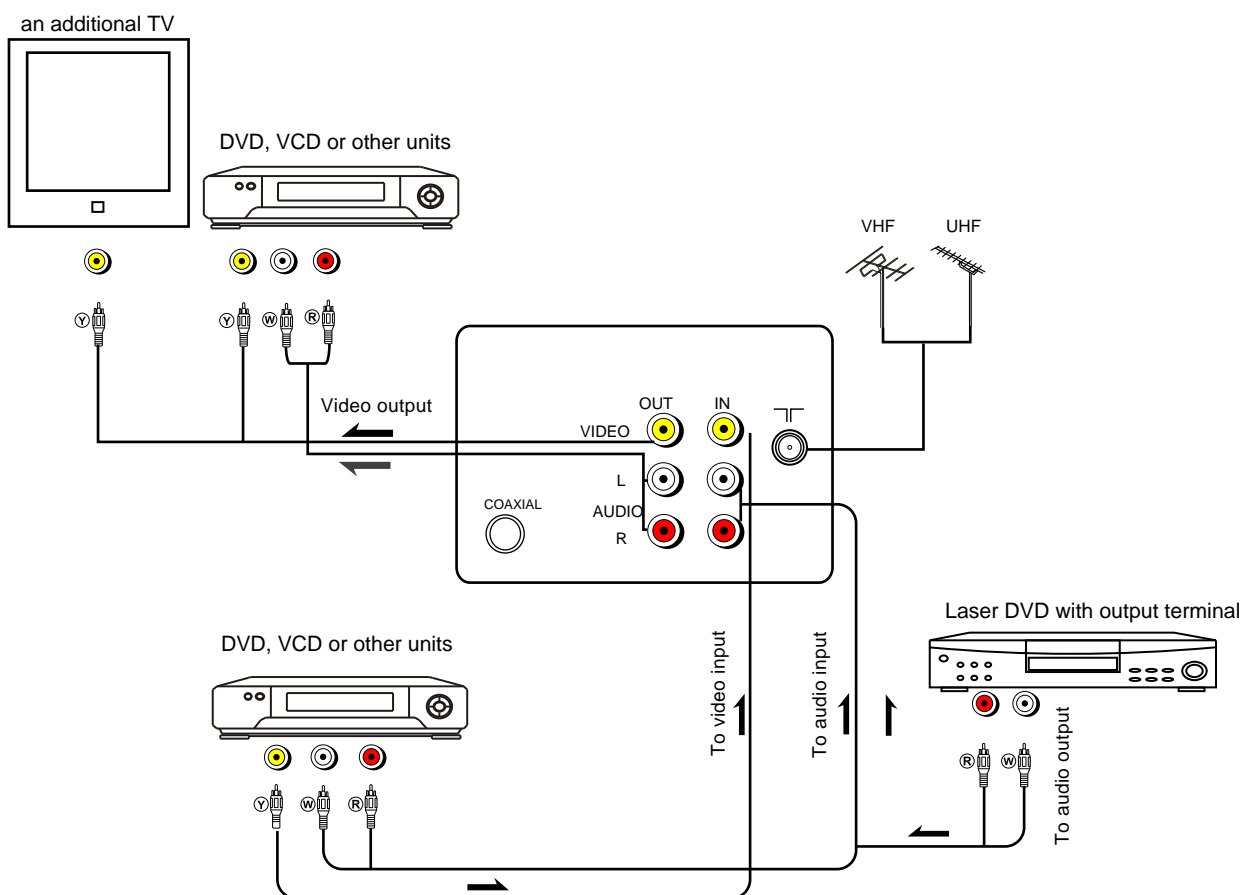



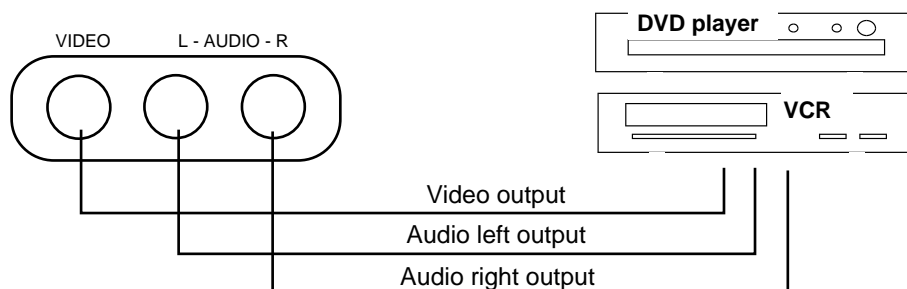







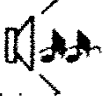

There is also an AV input on the side of your television. Use the Left Audio input (white terminal on the TV), if you are connecting equipment with mono sound. The MONO sound will be delivered by both left and right speakers.

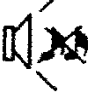

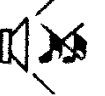
Troubleshooting Guide

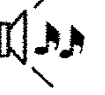
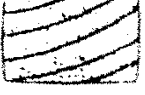
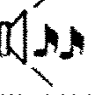
- To assist in location possible faults use help guide below.

BREAKDOWN PHENOMENON		CHECKING
PICTURE	SOUND	
 Picture with snow	 Noise	The aerial direction and connection
 Double or Triple Image	 Normal	This is called ghosting which can be minimised with an outside aerial, and good quality cable and terminations. Altering the aerial direction can also minimise this effect.
 Disturb	 Noise	Electrical interference which can be caused by cars, motorbikes etc, Fluorescent lamps and dirty insulators on overhead power cables.
 Normal	 No sound	Volume Sound mute
 No Picture	 No sound	Ensure that the power supply is connected to the TV set and turned on. Also ensure that the TV set is not in "Listen Mode" or that the brightness and contrast are not turned down.
 No colour	 Normal volume	Adjust colour control
 Scramble	 Normal or Weak Volume	Adjust channel again
 Colour Spot	 Normal volume	Colour Purity fault which can be caused by moving the TV set, placing magnets near the TV screen or turning on/off house hold appliances such as vacuum cleaners near the TV set. Turn the TV off with the mains power switch for 15 minutes. When the power is turn on again the TV set will automatically demagnetise the screen. In severe cases you may need to repeat this process.

Note:

1. If the fault can not be repaired using the above guide consult with your local authorised service centre. The TV set must only be repaired by a qualified registered service person. Never attempt to remove the back cover as TV set has dangerous voltages inside that may cause a fatality or fire.
2. The cabinet may produce the occasional "snapping sound". This is normal and caused by the materials in the cabinet expanding with room temperature changes.

Specifications

Specifications

Model	3415VD
Colour system	PAL, NTSC PLAYBACK
Sound system	BG
Picture tube	34cm colour picture tube
Sound output power	2X2W (10% THD)
Power requirements	AC 240V ~ 50Hz
Power consumption	70W
Dimension	356 (Width) x 370 (Depth) x 367 (Height) mm
Accessories	Remote control X1 Owner's manual X1 Battery (AAA) X2

NOTE

Design and specifications are subject to change without notice.
Dimensions quoted in this manual are approximate.

PALSONIC CORPORATION PTY LTD
1 JOYNTON AVENUE
WATERLOO NSW 2017 AUSTRALIA
TEL: (02) 9313 7111
FAX: (02) 9313 7555
www.palsonic.com.au

**PALSONIC CUSTOMER SERVICE
TELEPHONE
AUSTRALIA: 1300 657 888**