

Personal Computer User Guide for DE7000 series



V3.0
2010/05/20

Disposal Instruction (US)

For better protection of our earth, please don't throw this electronic device into municipal trash bin when discarding.

To minimize pollution and ensure utmost protection of the global environment, please recycle the product. For more information about the collection and recycling of Waste Electrical and Electronic Equipment (WEEE), you are invited to visit our homepage at www.aopen.com under “Green Products”

廃棄上の指示

より良い地球保護のために、電子機器を廃棄処分にする時は、ゴミ箱に捨てないで下さい。汚染を最小限に抑え、地球環境の最大限の保護のために、製品をリサイクルして下さい。 廃電気電子機器 (WEEE) の回収とリサイクルについての情報は、弊社ホームページ www.aopen.com の “Green Products” (環境に優しい製品) をご覧下さい。

廢棄及回收處理

爲了保護環境，請勿將本產品當作一般廢棄物處理。爲減少環境污染，維護地球資源，本產品報廢時，請回收本產品。

Instruktion til bortskaffelse (Danish)

Af hensyn til vores miljø bedes De ikke bortskaffe denne elektroniske enhed i en almindelig affaldsspand. For at mindske forurening og sikre beskyttelse af miljøet bedes De genbruge produktet. For yderligere information vedrørende indsamling og genbrug af elektronik-affald (Waste Electrical and Electronic Equipment (WEEE)) er De velkommen til at besøge vores website www.aopen.com og læse nærmere under "Green Products".

Verwijderingsinstructie (Dutch)

Om mogelijke schade aan het milieu of de menselijke gezondheid door ongecontroleerde afvalverwijdering te voorkomen, moet u dit elektronisch product scheiden van andere soorten afval en op een verantwoorde manier recyclen. Verwijder dit product dan ook alstublieft niet samen met ander huishoudelijk afval. Voor meer informatie over de verzameling en recycling van elektrisch afval en elektronische apparatuur (WEEE), nodigen we u uit om onze homepage te bezoeken www.aopen.com onder "Green Products".

Instruction de Disposition (French)

Pour une meilleure protection de la terre, ne jetez pas ce dispositif électronique dans la poubelle municipale lors de la disposition. Pour éliminer la pollution et assurer la plus grande protection de l'environnement global, réutilisez s'il vous plaît le produit. Pour plus d'informations sur la gestion des déchets d'Equipements Electriques et Electroniques (DEEE ou WEEE), vous êtes invité à visiter notre site à www.aopen.com sous " Green Products".

Entsorgungsanleitung (German)

Zum besseren Schutze unseres Planeten, schmeissen Sie elektrische Geräte bitte nicht in öffentliche Mülleimer. Zur Verringerung der Verschmutzung und zur Sicherstellung grösstmöglichen Schutzes der Umwelt recyceln Sie bitte das Produkt. Für mehr Informationen zum Sammeln und Recyceln von elektrischen und elektronischen Müll (WEEE) besuchen Sie bitte unsere Homepage unter www.aopen.com unter dem Punkt "Green Products".

Istruzioni per lo smaltimento (Italian)

Per una migliore salvaguardia del nostro pianeta, si prega di non gettare questo dispositivo elettronico nei normali rifiuti al momento dell'eliminazione. Per ridurre al minimo l'inquinamento ed assicurare la massima protezione dell'ambiente, si prega di riciclare il prodotto. Per maggiori informazioni riguardanti la raccolta ed il riciclaggio delle apparecchiature elettriche ed elettroniche residue (WEEE), siete invitati a visitare la nostra homepage www.aopen.com alla voce "Green Products".

Instruksjoner for Resirkulering og Oppsamling (Norwegian)

For å beskytte vår planet, kast ikke dette elektroniske utstyret sammen med vanlig avfall. For å beskytte vår natur og miljø, vennligst resirkuler dette produktet. For mer informasjon om oppsamling og resirkulering i henhold til Waste Electrical and Electronic Equipment (WEEE), se vår hjemmeside på www.aopen.com under "Green Products".

REEE - Programa de Tratamento de Resíduos de Equipamentos Eléctricos e Electrónicos (Portuguese)

Para melhor protecção ambiental do nosso planeta terra, não coloque o dispositivo electrónico no receptáculo de lixo municipal. Para minimizar a poluição e garantir protecção máxima do ambiente global, recicle o produto. Para mais informações sobre acerca da recolha e reciclagem de Equipamento Eléctrico e Electrónico (WEEE), convidamos-lhe a visitar nossa página na Internet em www.aopen.com sobre "Green Products".

Instrucciones para depositar los productos electrónicos (Spanish)

Para proteger mejor el medio ambiente, por favor, no deposite los productos electrónicos en los contenedores de basura tradicionales. Para reducir la contaminación y proteger el medio ambiente se recomienda que los recicle. Para más información acerca de dónde depositar y cómo reciclar Equipos Electrónicos y Desperdicios Electrónicos (WEEE), por favor, visite la página web www.aopen.com y entre en la sección Productos Ecológicos (“Green Products”).

Kassering (Swedish)

För att bättre värna om vår jord bör denna elektroniska utrustning ej kasseras tillsammans med vanligt avfall. För att minimera mängden föroreningar och så långt som möjligt skydda den globala miljön bör produkten återvinnas. För vidare information om insamling och återvinning av uttjänta elektriska och elektroniska produkter (Waste Electrical and Electronic Equipment, WEEE), besök avsnittet "Green Products" på vår hemsida, www.aopen.com.

Copyright

Copyright of this publication belongs to AOpen Inc. AOpen reserves the right to change the content of this publication without obligation to notify any party of such changes or revisions. No part of this publication may be reproduced, transcribed, transmitted, translated into any language, stored in a retrieval system in any form or by any means electronically, mechanically, optically without the prior written permission of this company.

Disclaimer

AOpen makes no warranties or representations, either expressed or implied, with respect to the content herein and specifically disclaims any warranties, merchantability of fitness for any particular purpose.

AOpen and AOpen logos used herein are registered trademarks of AOpen Inc.
All other brand names and trademarks are owned by their respective owners.

Copyright © 2007 by AOpen Inc.

All rights reserved.

Safety Instructions

1. Please read these safety instructions carefully.
2. Please keep this User's Manual for later reference.
3. Please disconnect this equipment from connector before cleaning. Don't use liquid or sprayed detergent for cleaning.
Use moisture sheet or cloth for cleaning.
4. Make sure the equipment is connected to the power source with the correct voltage, frequency, and ampere.
5. All cautions and warnings on the equipment should be noted.
6. Never pour any liquid into opening; this could cause fire or electrical shock.
7. Never open the equipment. For safety reason, the equipment should only be opened by qualified service personnel.
8. If one of the following situations arises, get the equipment checked by a service personnel :
 - a. Liquid has penetrated into the equipment.
 - b. The equipment has been exposed to moisture.
 - c. The equipment has not work well or you can not get it work according to user's manual.
 - d. The equipment has dropped and damaged.
 - e. If the equipment has obvious sign of breakage.
9. Caution on use of battery: Use the battery recommended by the manufacturer or the same type of battery installed by the manufacturer. If incorrect battery is used, it may cause explosion or fire hazard. Recycle or discard used batteries according the manufacturer's instruction or your local authority.
10. Safety caution concerning laser products:

DVD-ROM/CD-RW combo drive is "Class I Laser Product" This equipment, built with DVD and/or CD disc drives using laser beam to read or write data on optical discs, is classified as "Class 1 laser product". While the laser optical drive is reading data from or writing data to an optical disc, do not force open the disc drive door. Press the Eject button to retrieve the optical disc only after the in-use indicator goes off.
11. Ambient operation temperature: less than 45 degrees C.

FCC notice

This device has been tested and found to comply with the limits for a Class B digital device pursuant to Part 15 of the FCC Rules. These limits are designed to provide reasonable protection against harmful interference in a residential installation. This device generates, uses, and can radiate radio frequency energy and, if not installed and used in accordance with the instructions, may cause harmful interference to radio communications.

However, there is no guarantee that interference will not occur in a particular installation. If this device does cause harmful interference to radio or television reception, which can be determined by turning the device off and on, the user is encouraged to try to correct the interference by one or more of the following measures:

- Reorient or relocate the receiving antenna.
- Increase the separation between the device and receiver.
- Connect the device into an outlet on a circuit different from that to which the receiver is connected.
- Consult the dealer or an experienced radio/television technician for help

Notice: Shielded cables

All connections to other computing devices must be made using shielded cables to maintain compliance with FCC regulations.

Notice: Peripheral devices

Only peripherals (input/output devices, terminals, printers, etc.) certified to comply with Class B limits may be attached to this equipment. Operation with non-certified peripherals is likely to result in interference to radio and TV reception.

Caution

Changes or modifications not expressly approved by the manufacturer could void the user's authority, which is granted by the Federal Communications Commission, to operate this computer.

Operation conditions

This device complies with Part 15 of the FCC Rules. Operation is subject to the following two conditions: (1) this device may not cause harmful interference, and (2) this device must accept any interference received, including interference that may cause undesired operation.

Notice: Canadian users

This Class B digital apparatus complies with Canadian ICES-003

Index

1. Outlook	2
2. Product Specification.....	4
3. Internal Connectors	5
4. Packing List.....	6
5. Chassis and Holder Dimension	7

1. Outlook

Front IO

(Optical Device is option item)

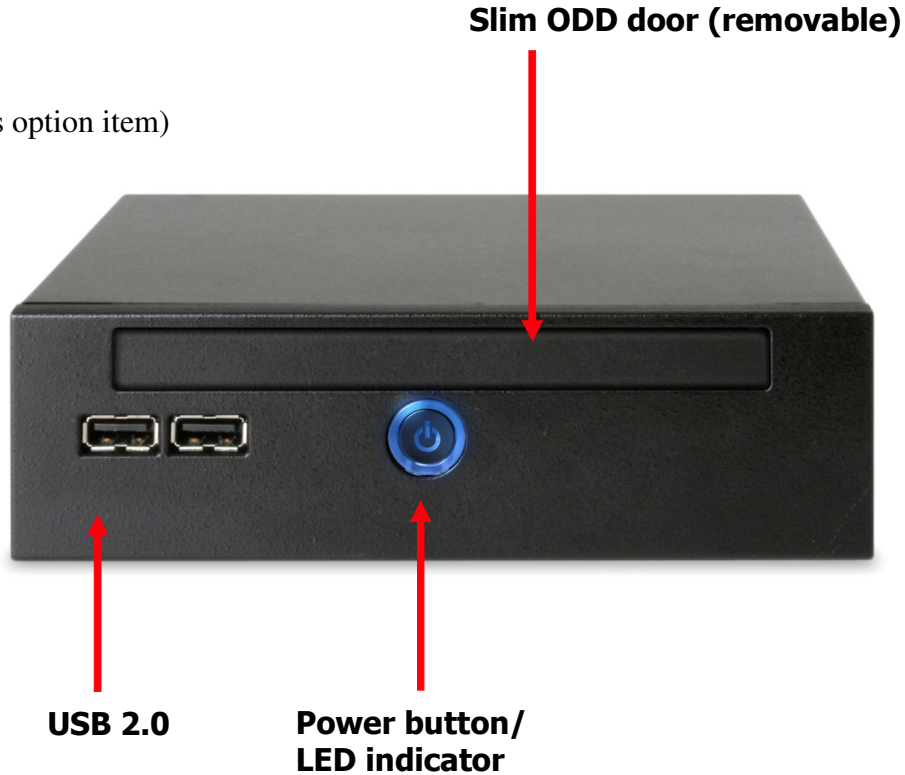

Rear IO

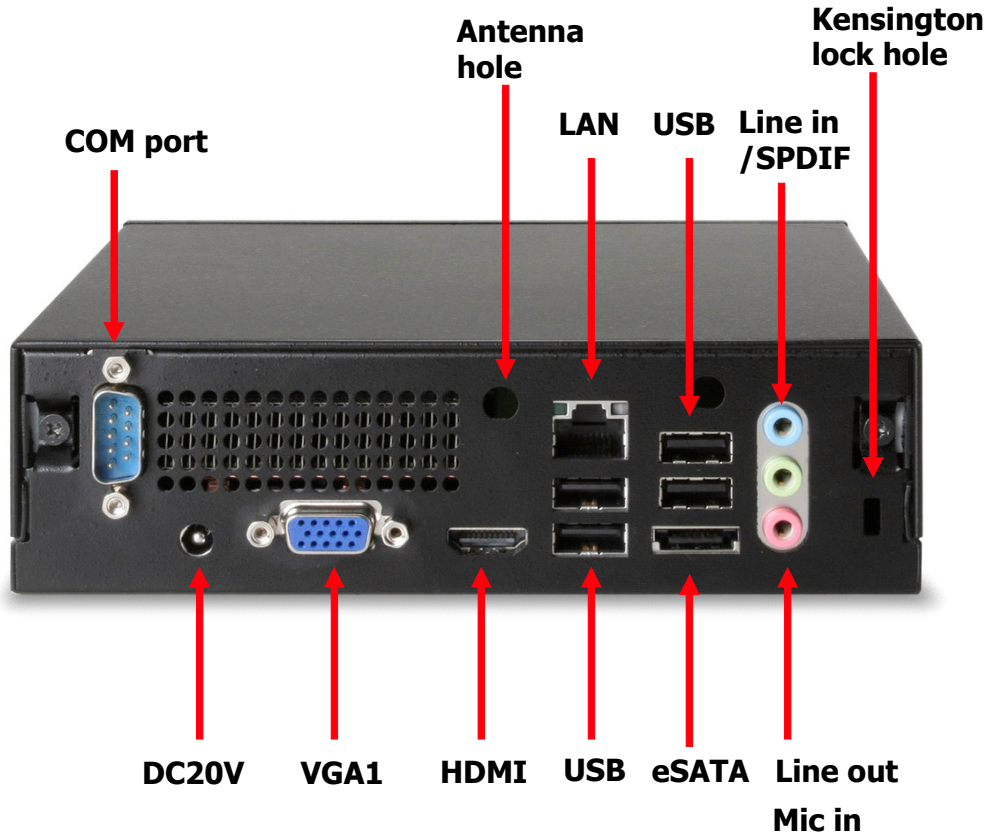

2. Product Specification

CPU	Socket P Support Intel Core 2 Duo and Celeron CPU, FSB 667/800/1066 MHz
Chipset	NVIDIA MCP7A-LP Chipset
Memory	Dual Channel Mode, SO-DIMM DDRⅢ x 2, 800/1066/1333 MHz Max memory size : 8GB
Graphics	Integrated Graphics GeForce 9300
Expansion Slot	mini Card Slot x 1, USB mini card bridge board x 1 (Option)
Audio	Realtek HD AUDIO CODEC ALC662
LAN	Realtek 10/100/1000 Mbps LAN Controller
Front Panel IO	Power Button x 1, HDD/Power indicator (Blue) x 1, USB 2.0 Port x 2
Rear Panel IO	DC 20V Jack x 1, HDMI Port x 1, D-Sub VGA Port x 1, RJ45 LAN Jack x 1, USB 2.0 Port x 4, RS232 Serial Port x 1, HD Audio ports (speaker out x 1, Mic in x 1, Line in x 1)
Adapter	90W (20V, 4.5A) AC Power Adapter
Input Voltage	AC 100 ~ 240V

3. Internal Connectors

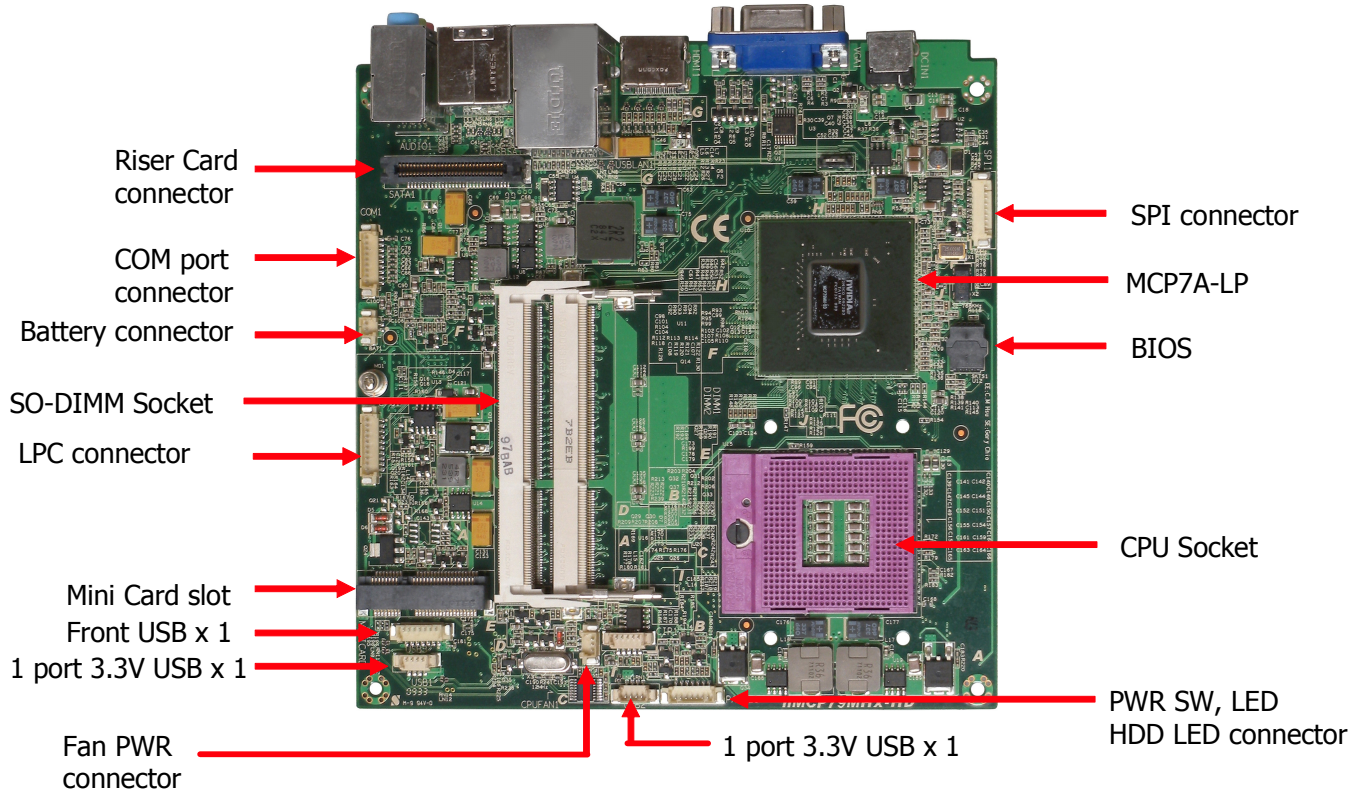

4. Packing List

- 1 x DE7000 system
- 1 x DE-SATA card
- 1 x User Guide
- 1 x Driver CD
- 1 x 90W Adapter and Power Cord
- 1 x L type Holder with 8 pcs of M3 screw
- 4 x M3 – L4 screws
- 4 x M2 – L2 screws
- 1 x HDMI to DVI cable (Option)
- 1 x cable clamp
- 1 x HDMI cable

5. Chassis and Holder Dimension

A. Dimension of DE7000 (unit: mm[inch])

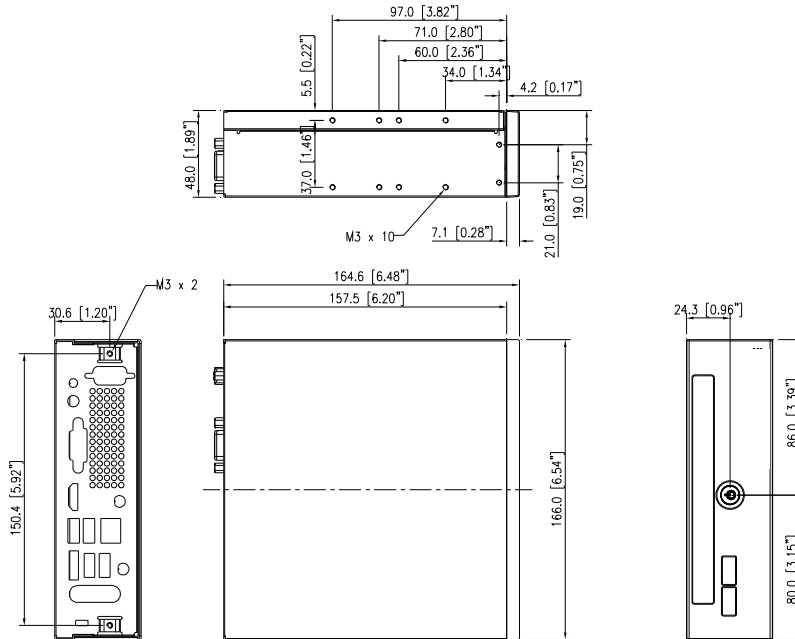

B. LH01 L type Holder(Include 2 piece holder and 8 FPH M3 screws)

B-1

L type Holder is a versatile holder, you can screw it on any place you want.



B-2

You can put on the L type Holder on 2 sides, and screw it tightly.



B-3 Dimension of L type Holder. (unit: mm)

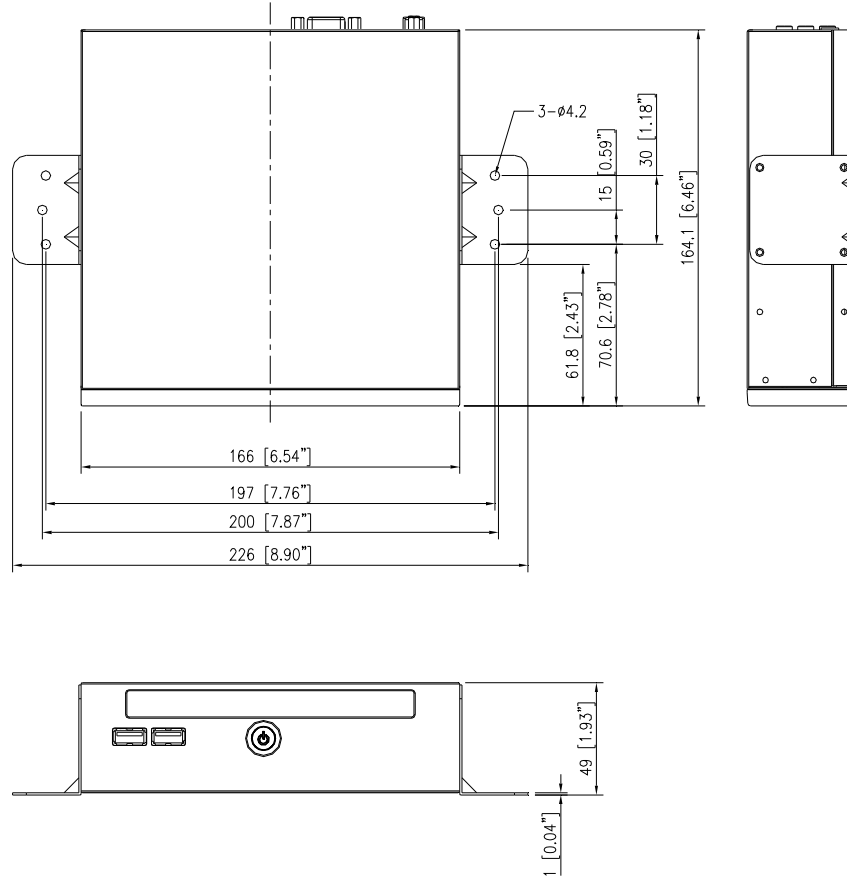

C.VM02 Monitor Holder (Include 2 piece holder and 4 FPH M3 and 4 FPH M4 screws)

C-1

Monitor Holder is base on VESA standard (10cm/7.5cm interval) for you to screw the Digital Engine behind the monitor. You can put on the Holder on monitor VESA mounting hole first, and screw it tightly, then put Digital Engine on VM02 holder and use 4 M3 screws to fix it.

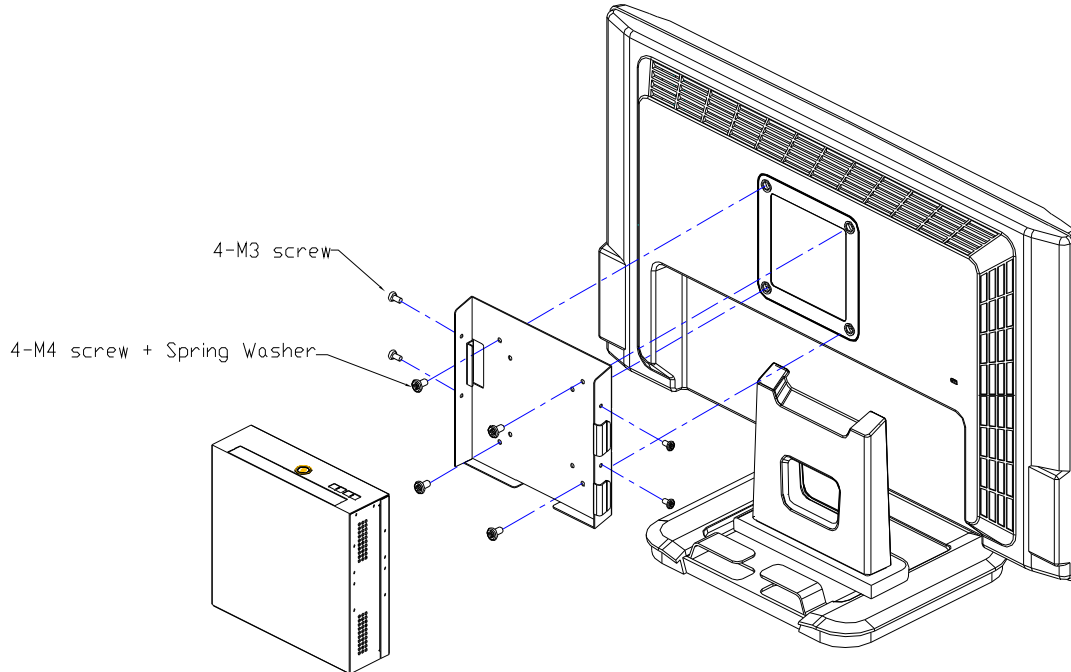

C-2 Dimension of VM02 Monitor Holder (unit: mm)

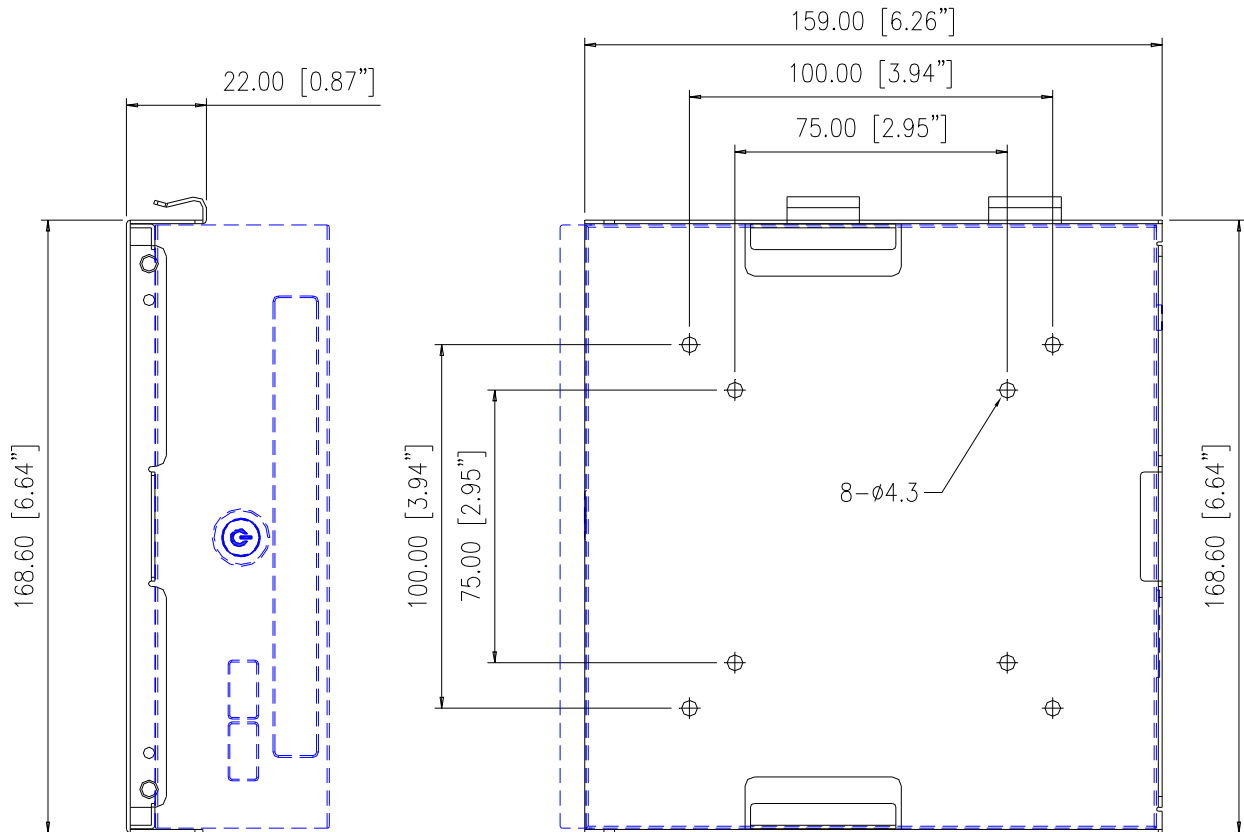

P/N : 49.ADE07.0030

S/N : 101-055-125