



***Emerson***<sup>®</sup>

***PERSONAL CD, CD-R/RW PLAYER***  
***with 60 SECOND JOGGABLE***  
***ANTI-SKIP PROTECTION***

***OWNER'S MANUAL***

***HD7096A***

***HD7099A (With Car Kit)***

Visit our web site at [www.emersonradio.com](http://www.emersonradio.com)



**Thank you.....**

For purchasing this Emerson Personal CD, CD-R/RW Player. It has a 24 track programmable memory so you can listen to the songs on your favorite CD's in any order you choose. Or you can use the Random playback feature and let the player select the playback order for you. Use the 3-way Repeat feature to repeat a single track, the entire disc, or a programmed sequence of tracks, indefinitely. We've also included a 60 Second Joggable Anti-Skip Memory which makes this player virtually skip-free during most active uses.

There's a Dynamic Bass Boost Control that increases and enhances the bass response and a set of digital quality, lightweight stereo headphones.

Please read this instruction manual completely and carefully to make sure you understand the proper operation of this product, and get the maximum enjoyment out of all the features of this state-of-the-art CD, CD-R/RW player.

Once again, thanks for purchasing this Emerson product.

The serial number of your CD player can be found on the bottom cabinet. We suggest that you record the serial number of your unit in the space below for future reference.

Model Number: **HD7096A**  
**HD7099A (with car kit)**

Serial Number: \_\_\_\_\_



## IMPORTANT NOTES

**WARNING: TO PREVENT FIRE OR SHOCK HAZARD,  
DO NOT EXPOSE THIS UNIT TO RAIN OR MOISTURE.**

Avoid installing the unit in locations described below:

- Places exposed to direct sunlight or  
lose to heat radiating appliances such  
as electric heaters.
- Dusty places.
- Places subject to constant  
vibration.
- Humid or moist places.

### CLASS 1 LASER PRODUCT

CLASS 1 LASER PRODUCT  
APPAREIL À LASER DE CLASSE 1  
PRODUCTO LASER DE CLASE 1

CAUTION  
INVISIBLE LASER RADIATION  
WHEN OPEN AND INTERLOCKS  
DEFEATED.  
AVOID EXPOSURE TO BEAM



**This product contains a low power Laser Device.**

### CAUTION

THIS LASER COMPACT DISC PLAYER FUNCTIONS BY HELP OF INVISIBLE LASER LIGHT AND IS EQUIPPED WITH SAFETY SWITCHES TO AVOID EXPOSURE WHEN DOOR IS OPEN AND SAFETY INTERLOCKS ARE DEFEATED. IT IS DANGEROUS TO DEFEAT OR BYPASS SAFETY SWITCHES.



#### DANGEROUS VOLTAGE

Uninsulated Dangerous Voltage, that may be of sufficient magnitude to constitute a risk of electric shock to persons is present within this product's enclosure.



#### ATTENTION

The Owner's Manual contains important operating and maintenance instructions.  
For your safety, it is necessary to refer to the manual.

This device complies with part 15 of the FCC rules. Operation is subject to the condition that this device does not cause harmful interference.

## LOCATION OF CONTROLS AND INDICATORS

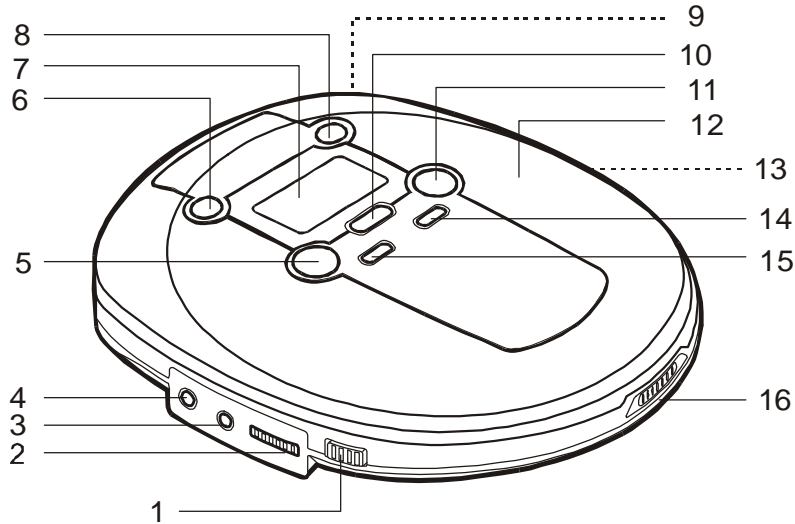

- 1.) DBBS (Bass Boost) ON/OFF Switch - Switch On to increase bass response.
- 2.) VOLUME Control – Raises or lowers the volume.
- 3.) PHONES (Headphone) Jack – Connect stereo headphones, included, to this jack.
- 4.) LINE OUT Jack – To connect this CD player to an external amplifier or recording device. Connection cable not included.
- 5.) STOP ■ Button – To stop playback, and to turn the power 'Off'.
- 6.) PROG (Program) Button – To program tracks in the CD memory.
- 7.) LCD Display – Shows Track number, Playing time, Joggable status, Program, Repeat, Random, and Intro modes.
- 8.) MODE Button – Selects the playback mode: Repeat 1/All, Random, or Intro.
- 9.) DC Input Jack – Connect an AC adapter (not included) to this jack to use 120V 60 Hz house current.
- 10.) ASP (Anti-Skip Protection) Button – Turns Anti-Skip system 'On' or 'Off'.
- 11.) PLAY/PAUSE ►|| Button – To begin playback, and to pause during playback.
- 12.) CD Door.
- 13.) Battery Compartment (on bottom cabinet).
- 14.) SKIP ►► Button – To skip tracks or search forward.
- 15.) SKIP ◀◀ Button – To skip tracks or search backward.
- 16.) OPEN Switch – Slide to the right to unlock and open the CD door.



## LCD DISPLAY INDICATORS

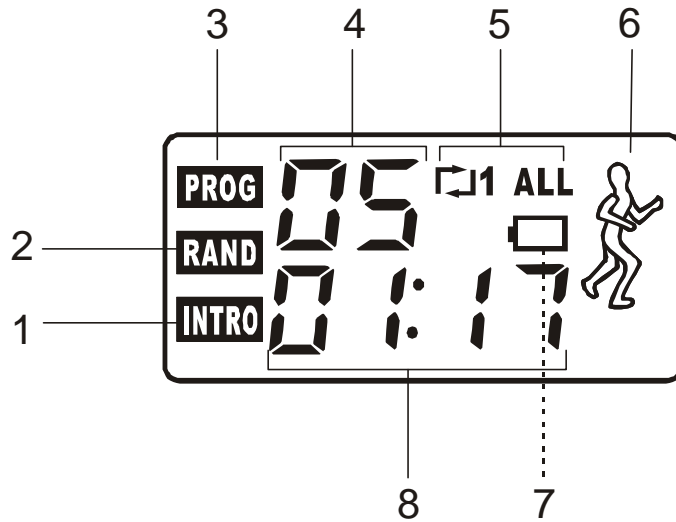

- 1.) INTRO Indicator – Appears when Intro playback mode is selected.
- 2.) RAND (Random) Indicator – Appears when Random playback mode is selected.
- 3.) PROG (Program) Indicator – Appears when programming tracks or playing programmed tracks.
- 4.) Track Number Display – Shows the track which is being played, and the total tracks on the disc.
- 5.) Repeat 1/ALL Indicators – Appears when the Repeat playback mode is selected.
- 6.) Anti-Skip Protection Indicator – Flashing icon indicates Anti-Skip Protection is activated.
- 7.) Battery Level Indicator – Blinks when batteries need to be replaced.
- 8.) Time Display – Shows elapsed time of the track being played and total playing time of the disc.



## POWER SOURCE

This CD player can be operated on either 120V 60Hz AC house current with an optional AC adapter (not included) or on 3V DC (2 "AA" batteries, not included).

### BATTERY OPERATION

1.) Open the battery compartment door on the bottom cabinet by sliding it in the direction of the arrow and then lifting it open. To prevent loss, the door cannot be removed from the unit.

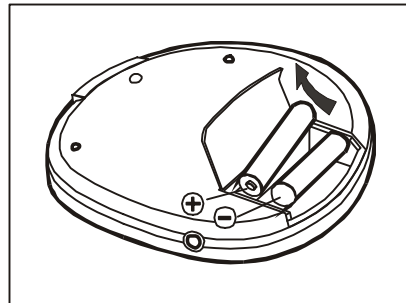

2.) Insert 2 "AA" batteries (not included) into the compartment. Use alkaline batteries for longest life. Follow the polarity markings inside the compartment. If the batteries are inserted incorrectly the unit will not work.

### NOTE:

In order to operate the player on batteries the optional AC adapter (not included) must be disconnected from the DC IN jack.

### BATTERY REPLACEMENT

When the batteries become too weak the battery level indicator "■" begins to flash and operation may become erratic. When this occurs replace the batteries immediately.

#### BATTERY PRECAUTIONS

Follow these precautions when using batteries in this device:

1. Use only the size and type of batteries specified.
2. Be sure to follow the correct polarity when installing the batteries as indicated in the battery compartment. Reversed batteries may cause damage to the device.
3. Do not mix different types of batteries together (e.g. Alkaline and Carbon-Zinc) or old batteries with fresh ones.
4. If the device is not to be used for a long period of time, remove the batteries to prevent damage or injury from possible battery leakage.
5. Do not try to recharge batteries not intended to be recharged; they can overheat and rupture (Follow battery manufacturer's directions.)



## AC OPERATION (AC Adapter not included)

Connect the AC adapter to your 120V AC outlet. Then connect the small plug to the "DC IN 4.5V" jack on the back of the player as shown in the following illustration.

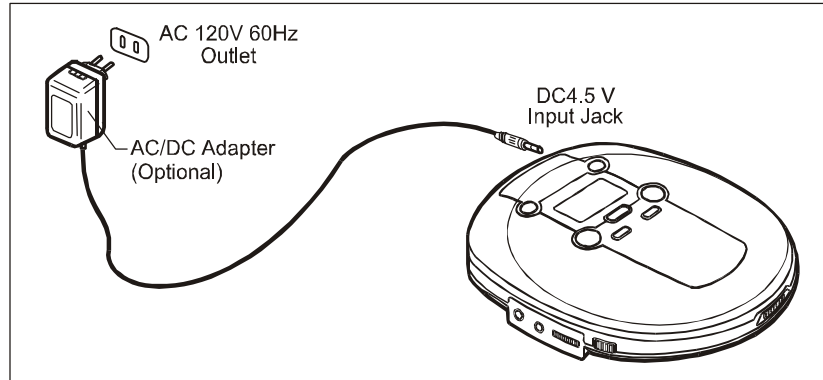

### NOTE:

This optional AC adapter, should be rated as follows:

Input : 120V / 60Hz AC.

Output : 4.5V DC 500mA.

The adapter must have a female-type plug with a positive center:



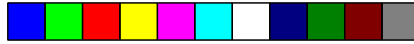

- Be sure the adapter is UL listed. If you use a "Universal"-type adapter, be sure to set the output selector to "DC 4.5V".
- If the AC adapter will not be used for an extended period of time, remove it from the wall outlet by pulling on the adapter housing. Do not remove the adapter by pulling on the cord. Do not touch the AC adapter with wet hands.



## OPERATING INSTRUCTIONS

### NORMAL PLAYBACK

**NOTE:** Although this CD player can read CD-R and CD-RW discs, in addition to normal CDs, the playability of CD-R and CD-RW discs may be effected by the type of software that was used to create the discs, as well as the quality and condition of the blank media you are using. 100% playability cannot be guaranteed. This is not an indication of a problem with the player.

- 1.) Connect the headphones to the PHONES jack. Set the VOLUME control to a low level before you begin playback and then adjust the volume to a comfortable level after playback begins.
- 2.) Slide the CD Door OPEN switch to the right to release the lock and open the CD Door.
- 3.) Place your disc on the center spindle with the printed label side facing up. Press down gently near the center hole to make sure the disc is properly seated on the spindle.
- 4.) Close the door completely until it locks shut.
- 5.) Press the PLAY/PAUSE  button to begin playback on Track 1. Joggable indicator flashes and the playing time shows in the display.
- 6.) Adjust the VOLUME and DBBS (Bass Boost) controls as desired.
- 7.) When all tracks have been played the player stops and the display shows the total tracks and playing time on the disc. After approximately 1 minute the power shuts off and the display goes blank.  
To stop playback before the disc ends press the STOP  button at any time. Press the STOP  button again to shut the power off immediately.
- 8.) Slide the CD Door OPEN switch to the right to open the door and remove your disc. Close the CD Door and return your disc to its protective storage case.

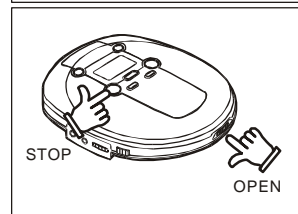
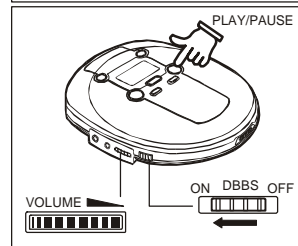
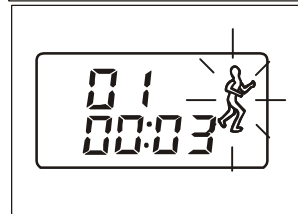
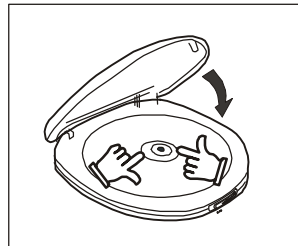
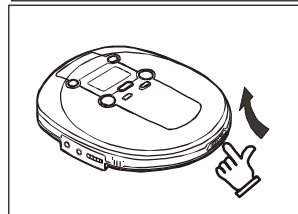
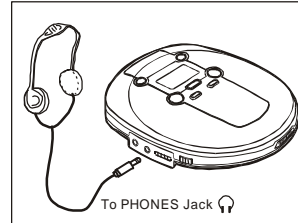





## PAUSE CONTROL

Press the PLAY/PAUSE ►|| button during playback to pause momentarily. The sound stops, the track and the time display flashes but the disc continues to spin. Press the PLAY/PAUSE ►|| button again to cancel pause and resume playback. The sound returns and the display stops flashing.

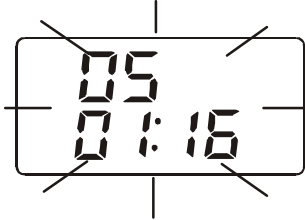

## SKIP/SEARCH CONTROLS

To skip forward or reverse to another track during playback press the SKIP ►► or SKIP ◄◄ buttons repeatedly until the desired track number appears in the display. Playback will begin on the desired track.

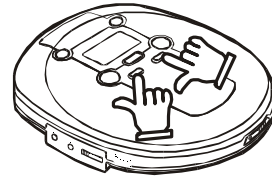

To search forward or backward within a track to locate a specific musical passage press and hold either the SKIP ►► or SKIP ◄◄ buttons. The player moves forward or reverse at high speed. When you reach the desired point in the track, release the buttons and normal playback resumes.

## REPEAT PLAYBACK

### To repeat a single track:

- 1.) Press PLAY/PAUSE ►|| button to begin playback.
- 2.) When playback begins press SKIP ►► or SKIP ◄◄ button to select the desired track.
- 3.) Press the MODE button once until the Repeat 1 "◄►1" indicator appears in the display. The selected track will be repeated indefinitely.

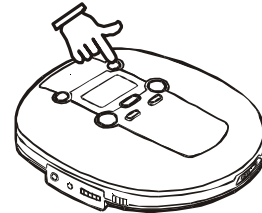

### To repeat the entire disc:

- 1.) Press PLAY/PAUSE ►|| button to begin playback.
- 2.) When playback begins press the MODE button twice until the Repeat All "◄►ALL" indicator appears in the display. The entire disc will be repeated indefinitely.



### To cancel repeat playback:

- 1.) Press the STOP ■ button, or;
- 2.) Press the MODE button until no special mode indicators appear in the display.



## INTRO SCAN

This feature plays only the first 10 seconds of each track on the disc.

1.) Press PLAY/PAUSE ►|| button to begin playback.

2.) When playback begins press the MODE button 3 times. The "INTRO" indicator flashes in the display.



3.) Press the STOP ■ button to stop the disc and then press the PLAY/PAUSE ►|| button again. The "INTRO" indicator stops flashing and remains 'On'. The player returns to the beginning of track 1 and plays just the first 10 seconds of each track on the disc. When the first 10 seconds of each track has been played, the player stops.

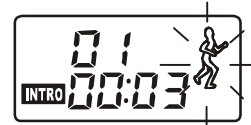

To cancel Intro Scan press the STOP ■ button or press the MODE button until none of the special playback mode indicators appear in the display.

## RANDOM PLAYBACK

Use Random playback to play all the tracks on a disc in a random order selected by the CD player.

1.) Press PLAY/PAUSE ►|| button to begin playback.

2.) When playback begins press the MODE button 4 times until the "RAND" indicator flashes in the display.



3.) Press the STOP ■ button to stop the disc and then press the PLAY/PAUSE ►|| button again. The "RAND" indicator stop flashing and remains on. The player randomly selects the first track for playback and continues randomly selecting tracks until every track on the disc has been played once. After all tracks have been played the player stops.



To cancel Random playback, press the STOP ■ button, or press the MODE button until no special mode indicators remain in the display.



## PROGRAMMED PLAYBACK

You can program the player to play only the tracks that you want to hear, in the specific order that you want to hear them. Up to a total of 24 tracks can be programmed. You may program certain tracks to play more than once if desired.

**IMPORTANT:** The player can only be programmed when it is in the Stop mode and the total number of tracks and playing time appear on the display. If the display is blank press the PLAY/PAUSE ►► button to start the disc. When playback begins press the STOP ■ button. If the disc was playing, press the STOP ■ button so that the total tracks and playing time appear on the display.

- 1.) While the total tracks and playing time appear on the display press the PROG (Program) button. "PROG" indicator flashes and Program No. "P - 01" appears.



- 2.) Press SKIP ►► or SKIP ◀◀ button until the first track to be programmed appears in the display. Example: Track # 7.

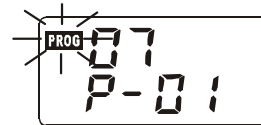

- 3.) Press the PROG (Program) button again to enter the selected track in the memory. The track indicator returns to a "00" and the Program No. advances to "P - 02".

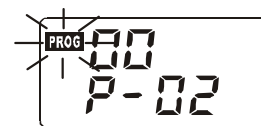

- 4.) Repeat Steps 2 and 3 until you have entered up to a total of 24 tracks in the memory.

- 5.) Press the PLAY/PAUSE ►► button to begin programmed playback. The "PROG" indicator stops flashing and remains in the display. The player will play the tracks you selected in the programmed order. When the last track has played the player stops and the total tracks and playing time appear.



- 6.) To cancel programmed playback press the STOP ■ button twice. The program will also be canceled if the CD Door is opened or if the power is interrupted.



## “JOGGABLE” ELECTRONIC ANTI-SKIP PROTECTION

This CD player is equipped with an automatic Jog-proof 60 second Electronic Anti-Skip Memory that will eliminate all skipping under normal conditions. This means that you can carry this unit while you are jogging and still enjoy skip free music. When you press the PLAY/PAUSE ►|| button to begin playback the player immediately begins to store 60 seconds of music in a solid state memory that is impervious to shock. The player is always reading the disc 60 seconds ahead of the music you are hearing and storing that information in the memory. If the player is subjected to shock or bumps of less than 60 seconds duration you will not notice them at all. If the bumps last longer than 60 seconds the anti-skip memory may be depleted and the player may skip or stop.

When playback begins the Jog-proof Anti-Skip indicator begins to flash rapidly in the display. When the Anti-Skip memory contains 60 seconds of music and is “full”, the indicator flashes slowly. If the player is bumped or shaken the indicator again flashes rapidly. The player may skip if the bumps continue. When the bumps stop the memory starts to fill up again and the flashing indicator will slow down.

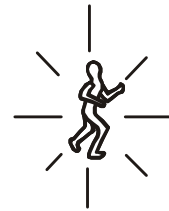

The Jog-proof Anti-Skip System does use additional battery power. Therefore if you are using this player in a stable location where it will not be subject to bumps and shocks, press the ASP button to switch the anti-skip circuitry ‘Off’. The Jog-proof indicator will disappear. This will reduce battery drain and prolong battery life.

**Note:** Each time you begin playing a disc the Jog-proof anti-skip system will turn ‘On’ automatically.

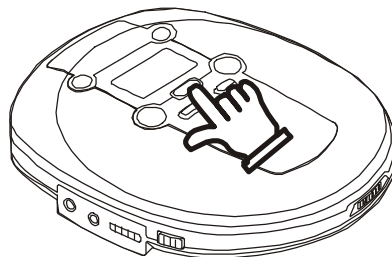



## CONNECTION TO AN EXTERNAL AUDIO SYSTEM

You can connect this CD player to a home stereo system, receiver, amplifier, or recorder if desired. Connect the LINE OUT jack of this CD player to the Left/Right Auxiliary Inputs, Line Inputs, or Record Inputs of the external device. The connection cable is NOT included. Set the DBBS(Bass Boost) switch of this CD player to the "OFF" position. Be sure to follow the external source connection instructions for the other equipment as well.

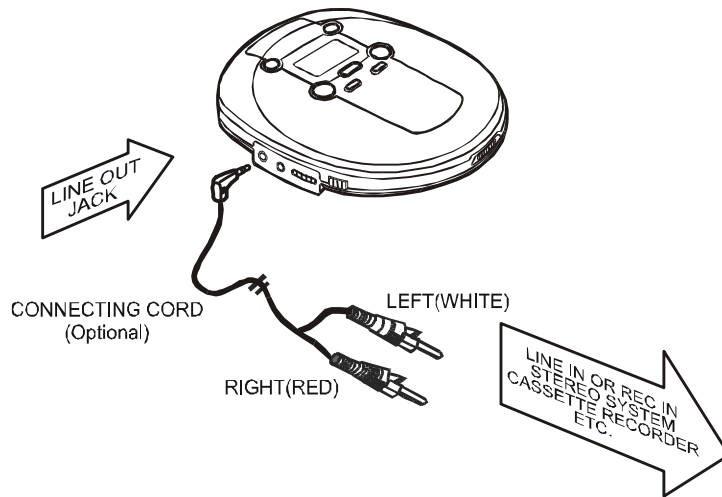



## USING THE CASSETTE ADAPTER (MODEL: HD7099A only)

Compact discs played in this unit can be heard through a cassette deck by using the CD cassette adapter. When listening to a CD in the car, use the CD cassette adapter and DC car cord to play a CD through a car stereo cassette deck.

### Operating instructions

- 1.) Press the cord into the groove on top of the cassette adapter so the plug is opposite the end inserted into the cassette deck. The cord should be able to exit the front of the cassette deck.

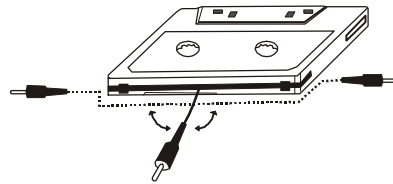

- 2.) Insert the cassette adapter plug into the LINE OUT jack of the CD player.
- 3.) Turn on the car stereo cassette deck, set the deck's volume to a low level and insert the cassette adapter with the THIS SIDE UP label facing upwards. If using an auto-reverse cassette deck, set the direction control as if playing the top side of the cassette adapter or the adapter will not work.

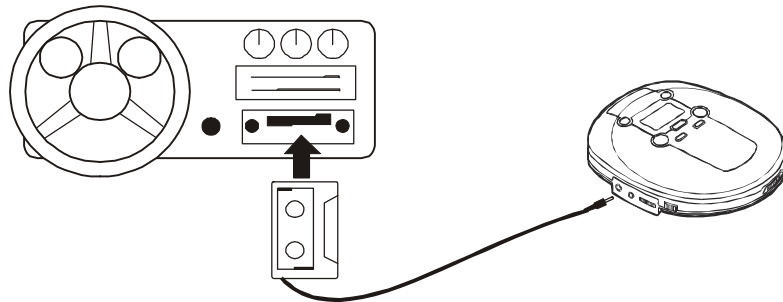

- 4.) Play the CD and adjust the volume on the car stereo cassette deck. The CD player's Volume control does not affect the volume.



### **USING THE DC CAR CORD (MODEL: HD7099A only)**

You can save money on batteries by using the DC Car Cord.

- 1.) Insert the small end of the DC Car Cord into the DC IN 4.5V Input Jack on the CD player.
- 2.) Insert the large end of the DC Car Cord into the car cigarette lighter socket.

#### **NOTES:**

- Do not use any other DC Car Cord with the unit or use any other CD player with this DC Car Cord.
- Unplug the DC Car Cord from the cigarette lighter when not in use to avoid draining the car's battery.
- Strong vibrations may cause the CD player to skip on rough surfaces if anti-skip feature is not being used, so position it securely when in the car.
- Do not leave on dashboard or exposed to direct sunlight as excessive heat may damage the unit.



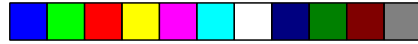

## CARE AND MAINTENANCE

### CLEANING THE CABINET

Wipe with a soft cloth. If the cabinet is very dirty, dampen the cloth with a weak solution of neutral detergent and water, and then wipe clean.

### CLEANING THE LENS

A dirty lens will cause sound skipping and, if the lens is very dirty, the CD may not work. Open the disc cover and clean the lens as follows:

#### DUST OR DRY PARTICLES

Using a camera lens brush/blower, blow on the lens several times, then wipe it lightly with the brush to remove dust. Then, blow on the lens once more.

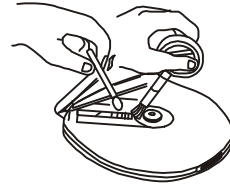

#### FINGERPRINTS

To remove fingerprints from the lens, use a cotton swab starting in the middle and working to the outside edge. Use only very light pressure on the lens to avoid forcing it out of alignment.

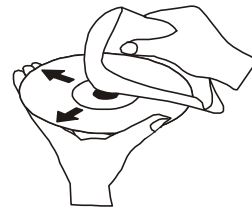

### CLEANING THE DISC

When a disc becomes dirty, clean it with a cleaning cloth. Wipe the disc from the center out.

#### NOTE:

Do not use solvents such as benzine, thinner, commercially available cleaners or anti-static spray intended for analog discs.





## TROUBLESHOOTING GUIDE

If you experience a problem with this unit, check the chart below before calling for service.

SYMPTOM	CAUSE	SOLUTION
Unit will not turn on.	Weak or dead batteries.	Replace batteries.
	CD compartment not closed.	Close CD compartment.
Disc will not play.	Disc inserted incorrectly.	Reinsert disc correctly.
	Dirty or defective disc.	Try another disc.
	Moisture or condensation on disc or lens.	Disc: wipe with soft cloth. Lens: see page 15. 'Care and Maintenance'
No sound from headphones.	Headphone plug not inserted correctly.	Reinsert headphone plug correctly.
	VOLUME controls set to minimum.	Raise volume controls on main unit and/or headphone cable.
	Weak batteries.	Replace batteries.
	Defective disc.	Try another disc.
Erratic playback.	Dirty or defective disc.	Clean or replace disc.



TO FIND THE LOCATION AND PHONE NUMBER OF YOUR NEAREST SERVICE CENTER PERMITTED TO PERFORM WARRANTY...

CALL TOLL FREE: 1-800-695-0098

FOR ADDITIONAL SET-UP OR OPERATING ASSISTANCE  
PLEASE CALL:  
1-800-898-9020

FOR CUSTOMER SERVICE, PLEASE WRITE TO:  
Emerson Radio Corp.  
Consumer Affairs Dept.  
1901 Diplomat Drive,  
Farmers Branch, TX 75234.



**LIMITED WARRANTY**

Emerson Radio Corp. warrants manufacturing defects in original material, including original parts and workmanship, under normal use and conditions, for a period of ninety (90) days from the date of original purchase in the U.S. With your dated proof of purchase, we will provide repair service at no charge for labor and parts at an authorized Depot Repair Facility, or replace the product in our discretion. For repair or replacement, pack your unit in a padded box, enclose your check or money order payable to Emerson Radio Corp. in the amount of \$9.00 (not required by California residents) to cover shipping and handling costs, and enclose a copy of your proof of purchase. Send your unit to:

Emerson Radio Corp.  
1901 Diplomat Drive.  
Farmers Branch, TX 75234.

This warranty does not cover damage from negligence, misuse, abuse, accident, failure to follow operating instructions, commercial use, rental, repairs by an unauthorized facility, or products purchased, used, serviced or damaged outside of the United States.

**THIS WARRANTY GIVES YOU SPECIFIC LEGAL RIGHTS, AND YOU MAY ALSO HAVE OTHER RIGHTS WHICH VARY FROM STATE TO STATE.**

**AU898M**



# EMERSON RADIO CORP.



**EMERSON**  
**PART NO. : 16-2912**  
**306-01**

**PRINTED IN CHINA**

