

Owner's Manual & Safety Instructions

Save This Manual Keep this manual for the safety warnings and precautions, assembly, operating, inspection, maintenance and cleaning procedures. Write the product's serial number in the back of the manual near the assembly diagram (or month and year of purchase if product has no number). Keep this manual and the receipt in a safe and dry place for future reference.

PROFESSIONAL SERIES
CHICAGO ELECTRIC
POWER TOOLS

ITEM 69342

1600W HEAVY DUTY HEAT GUN



Visit our website at: <http://www.harborfreight.com>
Email our technical support at: tech@harborfreight.com

When unpacking, make sure that the product is intact and undamaged. If any parts are missing or broken, please call 1-800-444-3353 as soon as possible.

Copyright© 2012 by Harbor Freight Tools®. All rights reserved.

No portion of this manual or any artwork contained herein may be reproduced in any shape or form without the express written consent of Harbor Freight Tools. Diagrams within this manual may not be drawn proportionally. Due to continuing improvements, actual product may differ slightly from the product described herein. Tools required for assembly and service may not be included.

⚠WARNING

**Read this material before using this product.
Failure to do so can result in serious injury.
SAVE THIS MANUAL.**

Table of Contents





Safety	2	Maintenance	10
Specifications	8	Parts List and Diagram	11
Setup	8	Warranty	12
Operation	9		

SAFETY

PROFESSIONAL SERIES CHICAGO ELECTRIC[®] POWER TOOLS

SETUP

WARNING SYMBOLS AND DEFINITIONS

	This is the safety alert symbol. It is used to alert you to potential personal injury hazards. Obey all safety messages that follow this symbol to avoid possible injury or death.
	Indicates a hazardous situation which, if not avoided, will result in death or serious injury.
	Indicates a hazardous situation which, if not avoided, could result in death or serious injury.
	Indicates a hazardous situation which, if not avoided, could result in minor or moderate injury.
	Addresses practices not related to personal injury.

OPERATION

IMPORTANT SAFETY INFORMATION

General Power Tool Safety Warnings

WARNING

Read all safety warnings and instructions.

Failure to follow the warnings and instructions may result in electric shock, fire and/or serious injury.

Save all warnings and instructions for future reference.

The term "power tool" in the warnings refers to your mains-operated (corded) power tool.

Work area safety

- Keep work area clean and well lit.**
Cluttered or dark areas invite accidents.
- Do not operate power tools in explosive atmospheres, such as in the presence of flammable liquids, gases or dust.** *Power tools create sparks which may ignite the dust or fumes.*
- Keep children and bystanders away while operating a power tool.**
Distractions can cause you to lose control.

MAINTENANCE

Electrical safety

- Power tool plugs must match the outlet. Never modify the plug in any way. Do not use any adapter plugs with grounded power tools.** *Unmodified plugs and matching outlets will reduce risk of electric shock.*
- Avoid body contact with grounded surfaces such as pipes, radiators, ranges and refrigerators.** *There is an increased risk of electric shock if your body is grounded.*
- Do not expose power tools to rain or wet conditions.** *Water entering a power tool will increase the risk of electric shock.*
- Do not abuse the cord. Never use the cord for carrying, pulling or unplugging the power tool. Keep cord away from heat, oil, sharp edges or moving parts. Damaged or entangled cords increase the risk of electric shock.**
- When operating a power tool outdoors, use an extension cord suitable for outdoor use.** *Use of a cord suitable for outdoor use reduces the risk of electric shock.*
- If operating a power tool in a damp location is unavoidable, use a Ground Fault Circuit Interrupter (GFCI) protected supply.** *Use of a GFCI reduces the risk of electric shock.*

Personal safety

- Stay alert, watch what you are doing and use common sense when operating a power tool. Do not use a power tool while you are tired or under the influence of drugs, alcohol or medication.** *A moment of inattention while operating power tools may result in serious personal injury.*
- Use personal protective equipment. Always wear eye protection.** *Safety equipment such as dust mask, non-skid safety shoes, hard hat, or hearing protection used for appropriate conditions will reduce personal injuries.*
- Prevent unintentional starting. Ensure the switch is in the off-position before connecting to power source, picking up or carrying the tool.** *Carrying power tools with your finger on the switch or energizing power tools that have the switch on invites accidents.*
- Do not overreach. Keep proper footing and balance at all times.** *This enables better control of the power tool in unexpected situations.*
- Only use safety equipment that has been approved by an appropriate standards agency.** *Unapproved safety equipment may not provide adequate protection. Eye protection must be ANSI-approved and breathing protection must be NIOSH-approved for the specific hazards in the work area.*

Power tool use and care

- Do not force the power tool. Use the correct power tool for your application.** *The correct power tool will do the job better and safer at the rate for which it was designed.*
- Do not use the power tool if the switch does not turn it on and off.** *Any power tool that cannot be controlled with the switch is dangerous and must be repaired.*
- Disconnect the plug from the power source before making any adjustments, changing accessories, or storing power tools.** *Such preventive safety measures reduce the risk of starting the power tool accidentally.*
- Store idle power tools out of the reach of children and do not allow persons unfamiliar with the power tool or these instructions to operate the power tool.** *Power tools are dangerous in the hands of untrained users.*
- Maintain power tools. Check for misalignment or binding of moving parts, breakage of parts and any other condition that may affect the power tool's operation. If damaged, have the power tool repaired before use.** *Many accidents are caused by poorly maintained power tools.*
- Use the power tool, accessories and tool bits etc. in accordance with these instructions, taking into account the working conditions and the work to be performed.** *Use of the power tool for operations different from those intended could result in a hazardous situation.*

Service

Have your power tool serviced by a qualified repair person using only identical replacement parts. This will ensure that the safety of the power tool is maintained.

Heat Gun Safety Warnings

1. **Hidden areas behind walls, ceilings, floors, soffit boards, and other panels may contain flammable materials that could be ignited by the heat gun when working in these locations.** The ignition of these materials may not be readily apparent and could result in property damage and injury to persons. When working in these locations, keep the heat gun moving in a back-and-forth motion. Lingering or pausing in one spot could ignite the panel or the material behind it.
2. **Extreme care should be taken when stripping paint.** The peelings, residue and vapors of paint may contain lead, which is poisonous. Any pre-1977 paint may contain lead and paint applied to homes prior to 1950 is likely to contain lead. Once deposited on surfaces, hand-to-mouth contact can result in the ingestion of lead. Exposure to even low levels of lead can cause irreversible brain and nervous system damage; young and unborn children are particularly vulnerable. Before beginning any paint removal process you should determine whether the paint you are removing contains lead. This can be done by your local health department or by a professional who uses a paint analyzer to check the lead content of the paint to be removed. **LEAD BASED PAINT SHOULD ONLY BE REMOVED BY A PROFESSIONAL AND SHOULD NOT BE REMOVED USING A HEAT GUN.**
3. **Exercise CAUTION when using this product outdoors.** To reduce the risk of electric shock, keep extension cord connection dry and off the ground.
4. **Persons removing paint should follow these guidelines:**
 - a. Move the work piece outdoors. If this is not possible, keep the work area well ventilated. Open the windows and put an exhaust fan in one of them. Be sure the fan is moving the air from inside to outside.
 - b. Remove or cover any carpets, rugs, furniture, clothing, cooking utensils and air ducts.
 - c. Place drop cloths in the work area to catch any paint chips or peelings. Wear protective clothing such as extra work shirts, overalls and hats.
 - d. Work in one room at a time. Furnishings should be removed or placed in the center of the room and covered. Work areas should be sealed off from the rest of the dwelling by sealed doorways with drop cloths.
 - e. Children, pregnant or potentially pregnant women, and nursing mothers should not be present in the work area until the work is done and all clean up is complete.
 - f. Wear a dust respirator mask or a dual filter (dust and fume) respirator mask which has been approved by the Occupational Safety and Health Administration (OSHA), the National Institute of Safety and Health (NIOSH), or the United States Bureau of Mines. These masks and replaceable filters are readily available at major hardware stores. Make sure the mask fits. Beards and facial hair may keep masks from sealing properly. Change filters often. **DISPOSABLE PAPER MASKS ARE NOT ADEQUATE.**
 - g. Use caution when operating the Heat Gun. Keep the Heat Gun moving, as excessive heat will generate fumes which can be inhaled by the operator.
 - h. Keep food and drink out of the work area. Wash hands, arms and face and rinse mouth before eating or drinking. Do not smoke or chew tobacco in the work area.
 - i. Clean up all removed paint and dust by wet mopping the floors. Use a wet cloth to clean all walls, sills and any other surface where paint or dust is clinging. **DO NOT SWEEP, DRY DUST OR VACUUM.** Use a high phosphate detergent or trisodium phosphate (TSP) to wash and mop areas.
 - j. At the end of each work session put the paint chips and debris in a double plastic bag, close it with tape or twist ties and dispose of properly.
 - k. Remove protective clothing and work shoes in the work area to avoid carrying dust into the rest of the dwelling. Wash work clothes separately. Wipe shoes off with a wet rag that is then washed with the work clothes. Wash hair and body thoroughly with soap and water.
5. When working with plastics, varnish, or similar materials, gases develop that are easily flammable and can lead to explosions. Be prepared for flames to develop and keep suitable fire extinguishing means at hand.
6. The Nozzle becomes very hot. Do not lay the Heat Gun on flammable surfaces when operating the Gun or immediately after turning the Gun off. Always set the Heat Gun on a flat, level surface so that the Nozzle tip is directed upwards and away from the supporting surface.

SAFETY

SETUP

OPERATION

MAINTENANCE

Heat Gun Safety Warnings (cont.)

7. Do not use the Heat Gun near flammable materials.
8. Do not point the Heat Gun at people or animals. The intense heat can injure them.
9. Do not touch the tube of the heating element or the Nozzle when they are hot. They will be hot enough to cause burns during use and for some time afterwards.
10. Do not use the Heat Gun on glass.
11. Do not use the Heat Gun as a hair dryer.
12. Do not heat up materials that can be damaged by high temperatures.
13. Maintain labels and nameplates on the tool. These carry important safety information. If unreadable or missing, contact Harbor Freight Tools for a replacement.
14. Avoid unintentional starting. Prepare to begin work before turning on the tool.
15. Do not leave the tool unattended when it is plugged into an electrical outlet. Turn off the tool, and unplug it from its electrical outlet before leaving.
16. This product is not a toy. Keep it out of reach of children.
17. People with pacemakers should consult their physician(s) before use. Electromagnetic fields in close proximity to heart pacemaker could cause pacemaker interference or pacemaker failure. In addition, people with pacemakers should:
 - Avoid operating alone.
 - Do not use with power switch locked on.
 - Properly maintain and inspect to avoid electrical shock.
 - Properly ground power cord. Ground Fault Circuit Interrupter (GFCI) should also be implemented – it prevents sustained electrical shock.
18. **WARNING:** Some dust created by power sanding, sawing, grinding, drilling, and other construction activities, contains chemicals known [to the State of California] to cause cancer, birth defects or other reproductive harm. Some examples of these chemicals are:
 - Lead from lead-based paints
 - Crystalline silica from bricks and cement or other masonry products
 - Arsenic and chromium from chemically treated lumberYour risk from these exposures varies, depending on how often you do this type of work. To reduce your exposure to these chemicals: work in a well ventilated area, and work with approved safety equipment, such as those dust masks that are specially designed to filter out microscopic particles. (California Health & Safety Code § 25249.5, *et seq.*)
19. **WARNING:** Handling the cord on this product will expose you to lead, a chemical known to the State of California to cause cancer, and birth defects or other reproductive harm. Wash hands after handling. (California Health & Safety Code § 25249.5, *et seq.*)
20. The warnings, precautions, and instructions discussed in this instruction manual cannot cover all possible conditions and situations that may occur. It must be understood by the operator that common sense and caution are factors which cannot be built into this product, but must be supplied by the operator.



SAVE THESE INSTRUCTIONS.

Grounding

⚠️ WARNING



TO PREVENT ELECTRIC SHOCK AND DEATH FROM INCORRECT GROUNDING WIRE CONNECTION:

Check with a qualified electrician if you are in doubt as to whether the outlet is properly grounded. Do not modify the power cord plug provided with the tool. Never remove the grounding prong from the plug. Do not use the tool if the power cord or plug is damaged. If damaged, have it repaired by a service facility before use. If the plug will not fit the outlet, have a proper outlet installed by a qualified electrician.

SAFETY

Grounded Tools: Tools with Three Prong Plugs

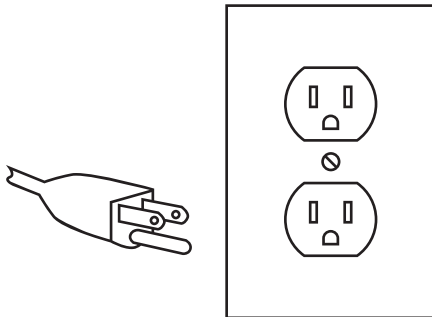

3-Prong Plug and Outlet

2. The grounding prong in the plug is connected through the green wire inside the cord to the grounding system in the tool. The green wire in the cord must be the only wire connected to the tool's grounding system and must never be attached to an electrically "live" terminal. **(See 3-Prong Plug and Outlet.)**
3. The tool must be plugged into an appropriate outlet, properly installed and grounded in accordance with all codes and ordinances. The plug and outlet should look like those in the preceding illustration. **(See 3-Prong Plug and Outlet.)**

1. Tools marked with "Grounding Required" have a three wire cord and three prong grounding plug. The plug must be connected to a properly grounded outlet. If the tool should electrically malfunction or break down, grounding provides a low resistance path to carry electricity away from the user, reducing the risk of electric shock. **(See 3-Prong Plug and Outlet.)**

SETUP

OPERATION

Double Insulated Tools: Tools with Two Prong Plugs

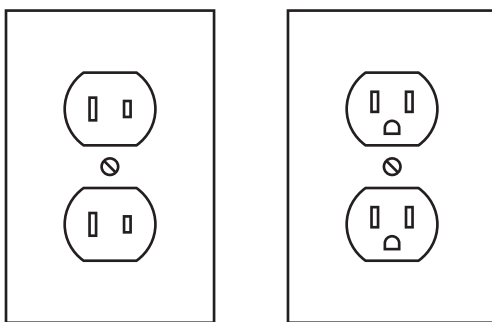

Outlets for 2-Prong Plug

1. Tools marked "Double Insulated" do not require grounding. They have a special double insulation system which satisfies OSHA requirements and complies with the applicable standards of Underwriters Laboratories, Inc., the Canadian Standard Association, and the National Electrical Code.
2. Double insulated tools may be used in either of the 120 volt outlets shown in the preceding illustration. **(See Outlets for 2-Prong Plug.)**

MAINTENANCE

Extension Cords







- Grounded** tools require a three wire extension cord. **Double Insulated** tools can use either a two or three wire extension cord.
- As the distance from the supply outlet increases, you must use a heavier gauge extension cord. Using extension cords with inadequately sized wire causes a serious drop in voltage, resulting in loss of power and possible tool damage. (See Table A on page 7.)
- The smaller the gauge number of the wire, the greater the capacity of the cord. For example, a 14 gauge cord can carry a higher current than a 16 gauge cord. (See Table A.)
- When using more than one extension cord to make up the total length, make sure each cord contains at least the minimum wire size required. (See Table A.)
- If you are using one extension cord for more than one tool, add the nameplate amperes and use the sum to determine the required minimum cord size. (See Table A.)
- If you are using an extension cord outdoors, make sure it is marked with the suffix "W-A" ("W" in Canada) to indicate it is acceptable for outdoor use.





- Make sure the extension cord is properly wired and in good electrical condition. Always replace a damaged extension cord or have it repaired by a qualified electrician before using it.
- Protect the extension cords from sharp objects, excessive heat, and damp or wet areas.

NAMEPLATE AMPERES (at full load)	EXTENSION CORD LENGTH				
	25'	50'	75'	100'	150'
0 – 2.0	18	18	18	18	16
2.1 – 3.4	18	18	18	16	14
3.5 – 5.0	18	18	16	14	12
5.1 – 7.0	18	16	14	12	12
7.1 – 12.0	18	14	12	10	-
12.1 – 16.0	14	12	10	-	-
16.1 – 20.0	12	10	-	-	-

* Based on limiting the line voltage drop to five volts at 150% of the rated amperes.

Symbology

	Double Insulated
	Canadian Standards Association
	Underwriters Laboratories, Inc.
	Volts Alternating Current
	Amperes
	No Load Revolutions per Minute (RPM)

	WARNING marking concerning Risk of Eye Injury. Wear ANSI-approved safety goggles with side shields.
	Read the manual before set-up and/or use.
	WARNING marking concerning Risk of Hearing Loss. Wear hearing protection.
	WARNING marking concerning Risk of Fire. Do not cover ventilation ducts. Keep flammable objects away.
	WARNING marking concerning Risk of Electric Shock. Properly connect power cord to appropriate outlet.

PROFESSIONAL SERIES
CHICAGO ELECTRIC
POWER TOOLS

Specifications

Electrical Rating	120V~ / 60Hz / 13A
Maximum Temperature	1100°F



Setup - Before Use:



Read the **ENTIRE IMPORTANT SAFETY INFORMATION** section at the beginning of this manual including all text under subheadings therein before set up or use of this product.

WARNING

TO PREVENT SERIOUS INJURY FROM ACCIDENTAL OPERATION:
Turn the Power Switch of the tool off and unplug the tool from its electrical outlet before assembling or making any adjustments to the tool.

Note: For additional information regarding the parts listed in the following pages, refer to *Parts List and Diagram* on page 11.

Setup

1. To increase the output temperature; use the Knob (7) to close the Vent Cover (8).
2. The Heat Gun can be set on its Base (35) to treat individual workpieces by hand.

Functions



Figure A

Operating Instructions



Read the **ENTIRE IMPORTANT SAFETY INFORMATION** section at the beginning of this manual including all text under subheadings therein before set up or use of this product.

WARNING

TO PREVENT SERIOUS INJURY:

Always wear thermally insulated gloves, rated to at least 1200° F, when working directly with pieces by hand.

Workpiece and Work Area Set Up

1. Designate a work area that is clean and well-lit. The work area must not allow access by children or pets to prevent distraction and injury.
2. Route the power cord along a safe route to reach the work area without creating a tripping hazard or exposing the power cord to possible damage. The power cord must reach the work area with enough extra length to allow free movement while working.
3. Secure loose workpieces using a vise or clamps (not included) to prevent movement while working.
4. There must not be objects, such as utility lines, nearby that will present a hazard while working.

General Operating Instructions

1. Plug the Power Cord of the tool into a 120 volt, grounded, electrical outlet.
2. The Switch on this heat gun has three positions. Point the gun in a safe direction and push the Switch up for the heat setting.
3. Allow the Heat Gun one minute to build up to the heat level.
4. The Heat Gun can be used for:
 - Shrinking of shrink tubing, packaging and electrical components.
 - Deforming of articles made from acrylic, PVC, and polystyrene tubing, plates, and profiles.
 - Welding of thermoplastic polymer, flooring materials of PVC and linoleum, PVC-coated fabric, wallpaper, tarpaulins and foils.
 - Soldering of tin, special silver solder, SMD elements, cable lugs, and for loosening soldered connections.
 - Paint removal. Removal of old coatings of oil paint, varnish, and synthetic plaster.
 - Drying of color shade samples, filter, adhesives, construction joints and stucco forms.
 - Joining adhesives. Large surface gluing with contact adhesives, activation of pressure, or heat sensitive adhesives, acceleration of bonding processes, releasing of bonding points as well as releasing or bonding of edge bond or veneer.
 - Defrosting of icy stairs and steps, door locks, trunk lids, car doors or metal water pipes.
 - Disinfection. With the tool set at the highest setting, animal sites/stables may be disinfected. Wood worm infestation may be controlled. Do not heat up the wood surface too much or it can burn.
5. **When the job is finished, move the Switch to the "COLD" setting and allow the Heat Gun to cool down on an insulated, non-flammable surface.**
6. When the unit has cooled, move the Switch to the "OFF" position.
7. Disconnect the power supply after use. Clean, then store the tool indoors out of children's reach.



WARNING! Do not touch work area with the Heat Gun; it could scorch or ignite.

Maintenance and Servicing



Procedures not specifically explained in this manual must be performed only by a qualified technician.

⚠️WARNING

TO PREVENT SERIOUS INJURY FROM ACCIDENTAL OPERATION:

Turn the Power Switch of the tool off and unplug the tool from its electrical outlet before performing any inspection, maintenance, or cleaning procedures.

TO PREVENT SERIOUS INJURY FROM TOOL FAILURE:

Do not use damaged equipment. If abnormal noise or vibration occurs, have the problem corrected before further use.

Cleaning, Maintenance, and Lubrication

- BEFORE EACH USE**, inspect the general condition of the tool. Check for:
 - loose hardware,
 - cracked or broken parts,
 - damaged electrical wiring, and
 - any other condition that may affect its safe operation.
- AFTER USE**, wipe external surfaces of the tool with clean cloth.
- ⚠️WARNING!** If the supply cord of this power tool is damaged, it must be replaced only by a qualified service technician.

Troubleshooting

Problem	Possible Causes	Likely Solutions
Heat Gun will not turn on.	<ol style="list-style-type: none">1. Cord not connected.2. No power at outlet.3. Power Switch set at "0".4. Internal damage or wear. (Switch, for example.)	<ol style="list-style-type: none">1. Check that cord is plugged in.2. Check power at outlet. If outlet is unpowered, turn off tool and check circuit breaker. If breaker is tripped, make sure circuit is right capacity for tool and circuit has no other loads.3. Turn Power Switch to "I" or "II".4. Have technician service tool.
Unsatisfactory results.	<ol style="list-style-type: none">1. Inappropriate heat for task.	<ol style="list-style-type: none">1. Adjust heat setting or distance to workpiece to compensate.



Follow all safety precautions whenever diagnosing or servicing the tool. Disconnect power supply before service.

PROFESSIONAL SERIES
CHICAGO  ELECTRIC[®]
POWER TOOLS

Parts List and Diagram

Part	Description	Qty	Part	Description	Qty
1	Nose Cone	1	20	Switch	1
2	Air Duct	1	21	Switch Board	1
3	Pad	1	22	Handle	1
4	Heat Element	1	23	Wire Strain Plate	1
5	Under Pan	1	24	Sheath	1
6	Block	1	25	Power Cord	1
7	Knob	1	26	Screw 4x8	6
8	Vent Cover	1	27	Screw 4x8	2
9	Left Housing	1	28	Screw 3x12	1
10	Spring	1	29	Screw 3x6	1
11	End Stop	1	30	Screw 3x8	1
12	Nut	1	31	Screw 3x6	4
13	Fan	1	32	Screw 4x6	2
14	Motor	1	33	Screw 3x13	3
15	Cord Stop 1	1	34	Terminal Block	1
16	Cord Stop 2	1	35	Base	1
17	Pad	1	36	Connector	3
18	Handle Stop Spring	1	37	Connector	1
19	Right Housing	1	38	Wire	2

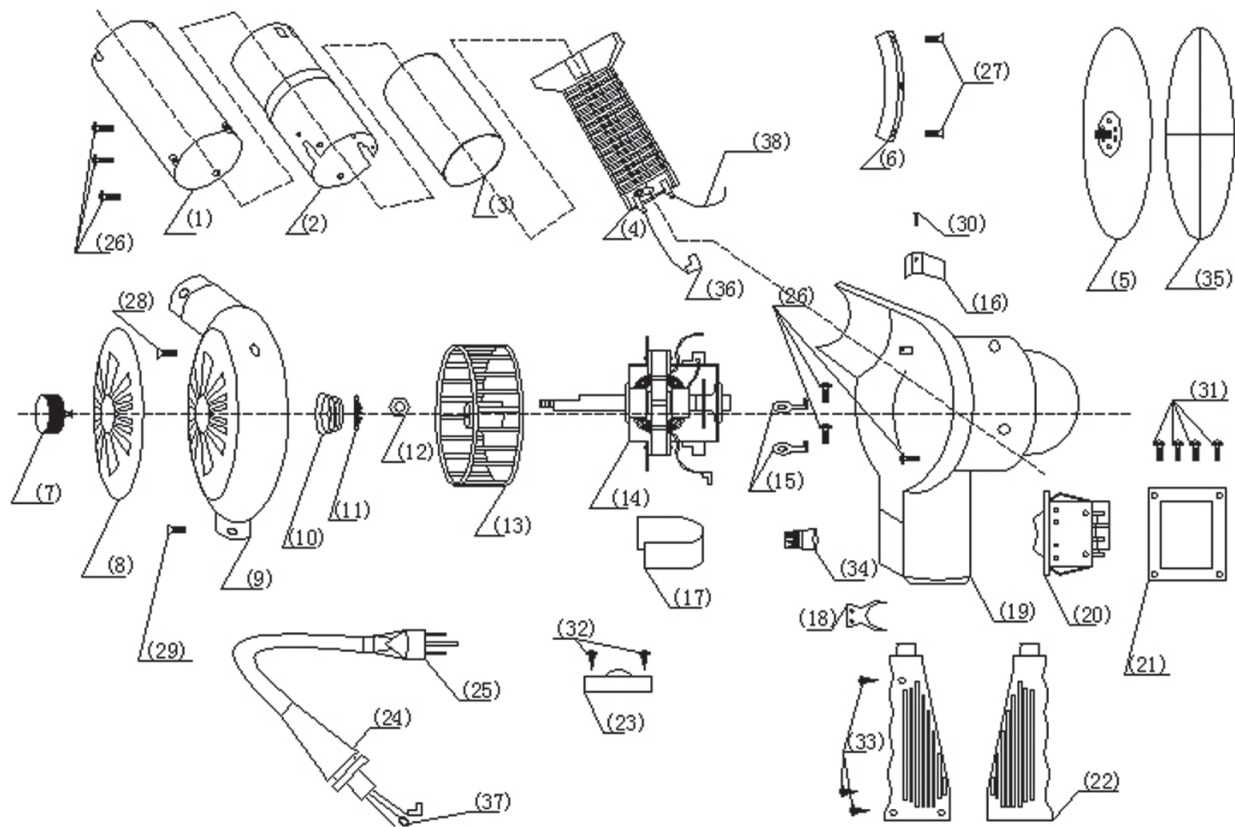

Record Product's Serial Number Here: _____

Note: If product has no serial number, record month and year of purchase instead.

Note: Some parts are listed and shown for illustration purposes only, and are not available individually as replacement parts.

PLEASE READ THE FOLLOWING CAREFULLY

THE MANUFACTURER AND/OR DISTRIBUTOR HAS PROVIDED THE PARTS LIST AND ASSEMBLY DIAGRAM IN THIS MANUAL AS A REFERENCE TOOL ONLY. NEITHER THE MANUFACTURER OR DISTRIBUTOR MAKES ANY REPRESENTATION OR WARRANTY OF ANY KIND TO THE BUYER THAT HE OR SHE IS QUALIFIED TO MAKE ANY REPAIRS TO THE PRODUCT, OR THAT HE OR SHE IS QUALIFIED TO REPLACE ANY PARTS OF THE PRODUCT. IN FACT, THE MANUFACTURER AND/OR DISTRIBUTOR EXPRESSLY STATES THAT ALL REPAIRS AND PARTS REPLACEMENTS SHOULD BE UNDERTAKEN BY CERTIFIED AND LICENSED TECHNICIANS, AND NOT BY THE BUYER. THE BUYER ASSUMES ALL RISK AND LIABILITY ARISING OUT OF HIS OR HER REPAIRS TO THE ORIGINAL PRODUCT OR REPLACEMENT PARTS THERETO, OR ARISING OUT OF HIS OR HER INSTALLATION OF REPLACEMENT PARTS THERETO.

Limited 90 Day Warranty

Harbor Freight Tools Co. makes every effort to assure that its products meet high quality and durability standards, and warrants to the original purchaser that this product is free from defects in materials and workmanship for the period of 90 days from the date of purchase. This warranty does not apply to damage due directly or indirectly, to misuse, abuse, negligence or accidents, repairs or alterations outside our facilities, criminal activity, improper installation, normal wear and tear, or to lack of maintenance. We shall in no event be liable for death, injuries to persons or property, or for incidental, contingent, special or consequential damages arising from the use of our product. Some states do not allow the exclusion or limitation of incidental or consequential damages, so the above limitation of exclusion may not apply to you. THIS WARRANTY IS EXPRESSLY IN LIEU OF ALL OTHER WARRANTIES, EXPRESS OR IMPLIED, INCLUDING THE WARRANTIES OF MERCHANTABILITY AND FITNESS.

To take advantage of this warranty, the product or part must be returned to us with transportation charges prepaid. Proof of purchase date and an explanation of the complaint must accompany the merchandise. If our inspection verifies the defect, we will either repair or replace the product at our election or we may elect to refund the purchase price if we cannot readily and quickly provide you with a replacement. We will return repaired products at our expense, but if we determine there is no defect, or that the defect resulted from causes not within the scope of our warranty, then you must bear the cost of returning the product.

This warranty gives you specific legal rights and you may also have other rights which vary from state to state.

PROFESSIONAL SERIES
CHICAGO  ELECTRIC®
POWER TOOLS

3491 Mission Oaks Blvd. • PO Box 6009 • Camarillo, CA 93011 • (800) 444-3353