



## **Cisco VG202, Cisco VG202XM, Cisco VG204, and Cisco VG204XM Voice Gateways Hardware Installation Guide**

### **Americas Headquarters**

Cisco Systems, Inc.  
170 West Tasman Drive  
San Jose, CA 95134-1706  
USA  
<http://www.cisco.com>  
Tel: 408 526-4000  
800 553-NETS (6387)  
Fax: 408 527-0883

Text Part Number: OL-15959-01

THE SPECIFICATIONS AND INFORMATION REGARDING THE PRODUCTS IN THIS MANUAL ARE SUBJECT TO CHANGE WITHOUT NOTICE. ALL STATEMENTS, INFORMATION, AND RECOMMENDATIONS IN THIS MANUAL ARE BELIEVED TO BE ACCURATE BUT ARE PRESENTED WITHOUT WARRANTY OF ANY KIND, EXPRESS OR IMPLIED. USERS MUST TAKE FULL RESPONSIBILITY FOR THEIR APPLICATION OF ANY PRODUCTS.

THE SOFTWARE LICENSE AND LIMITED WARRANTY FOR THE ACCOMPANYING PRODUCT ARE SET FORTH IN THE INFORMATION PACKET THAT SHIPPED WITH THE PRODUCT AND ARE INCORPORATED HEREIN BY THIS REFERENCE. IF YOU ARE UNABLE TO LOCATE THE SOFTWARE LICENSE OR LIMITED WARRANTY, CONTACT YOUR CISCO REPRESENTATIVE FOR A COPY.

The following information is for FCC compliance of Class A devices: This equipment has been tested and found to comply with the limits for a Class A digital device, pursuant to part 15 of the FCC rules. These limits are designed to provide reasonable protection against harmful interference when the equipment is operated in a commercial environment. This equipment generates, uses, and can radiate radio-frequency energy and, if not installed and used in accordance with the instruction manual, may cause harmful interference to radio communications. Operation of this equipment in a residential area is likely to cause harmful interference, in which case users will be required to correct the interference at their own expense.

The following information is for FCC compliance of Class B devices: The equipment described in this manual generates and may radiate radio-frequency energy. If it is not installed in accordance with Cisco's installation instructions, it may cause interference with radio and television reception. This equipment has been tested and found to comply with the limits for a Class B digital device in accordance with the specifications in part 15 of the FCC rules. These specifications are designed to provide reasonable protection against such interference in a residential installation. However, there is no guarantee that interference will not occur in a particular installation.

Modifying the equipment without Cisco's written authorization may result in the equipment no longer complying with FCC requirements for Class A or Class B digital devices. In that event, your right to use the equipment may be limited by FCC regulations, and you may be required to correct any interference to radio or television communications at your own expense.

You can determine whether your equipment is causing interference by turning it off. If the interference stops, it was probably caused by the Cisco equipment or one of its peripheral devices. If the equipment causes interference to radio or television reception, try to correct the interference by using one or more of the following measures:

- Turn the television or radio antenna until the interference stops.
- Move the equipment to one side or the other of the television or radio.
- Move the equipment farther away from the television or radio.
- Plug the equipment into an outlet that is on a different circuit from the television or radio. (That is, make certain the equipment and the television or radio are on circuits controlled by different circuit breakers or fuses.)

Modifications to this product not authorized by Cisco Systems, Inc. could void the FCC approval and negate your authority to operate the product.

The Cisco implementation of TCP header compression is an adaptation of a program developed by the University of California, Berkeley (UCB) as part of UCB's public domain version of the UNIX operating system. All rights reserved. Copyright © 1981, Regents of the University of California.

NOTWITHSTANDING ANY OTHER WARRANTY HEREIN, ALL DOCUMENT FILES AND SOFTWARE OF THESE SUPPLIERS ARE PROVIDED "AS IS" WITH ALL FAULTS. CISCO AND THE ABOVE-NAMED SUPPLIERS DISCLAIM ALL WARRANTIES, EXPRESSED OR IMPLIED, INCLUDING, WITHOUT LIMITATION, THOSE OF MERCHANTABILITY, FITNESS FOR A PARTICULAR PURPOSE AND NONINFRINGEMENT OR ARISING FROM A COURSE OF DEALING, USAGE, OR TRADE PRACTICE.

IN NO EVENT SHALL CISCO OR ITS SUPPLIERS BE LIABLE FOR ANY INDIRECT, SPECIAL, CONSEQUENTIAL, OR INCIDENTAL DAMAGES, INCLUDING, WITHOUT LIMITATION, LOST PROFITS OR LOSS OR DAMAGE TO DATA ARISING OUT OF THE USE OR INABILITY TO USE THIS MANUAL, EVEN IF CISCO OR ITS SUPPLIERS HAVE BEEN ADVISED OF THE POSSIBILITY OF SUCH DAMAGES.

Cisco and the Cisco logo are trademarks or registered trademarks of Cisco and/or its affiliates in the U.S. and other countries. To view a list of Cisco trademarks, go to this URL: [www.cisco.com/go/trademarks](http://www.cisco.com/go/trademarks). Third-party trademarks mentioned are the property of their respective owners. The use of the word partner does not imply a partnership relationship between Cisco and any other company. (1110R)

*Cisco VG202, Cisco VG202XM, Cisco VG204, and Cisco VG204XM Voice Gateways Hardware Installation Guide*  
Copyright © 2008-2013 Cisco Systems, Inc. All rights reserved.



## **Preface** v

- Audience v
- Documentation Conventions v
- Accessibility vi
- Related Documentation vi
- Obtaining Documentation and Submitting a Service Request vii
- Safety Warnings vii
  - Warning Definition vii

---

## **CHAPTER 1**

### **Overview of the Cisco VG202, Cisco VG202XM, Cisco VG204, and Cisco VG204XM Voice Gateways** 1-1

- Overview 1-1
- Physical Description 1-2
  - Front Panel Description 1-2
  - Back Panel Description 1-3
  - LEDs 1-4
  - Product Serial Number Location 1-5
- Port Numbering Conventions 1-6
- Interfaces and Service Capabilities 1-6
- Software Elements 1-7
  - Operating System 1-7
  - Configuration Connections 1-7
- Memory 1-8
- Hardware and Electrical Specifications 1-8
- Chassis Grounding 1-8
- Voice Gateway Deployment 1-9

---

## **CHAPTER 2**

### **Planning Your Installation** 2-1

- Location and Mounting Requirements 2-1
  - About Mounting Location Requirements 2-1
  - Access to the Chassis 2-1
  - Power Source 2-2
  - Temperature Control and Ventilation 2-2

- Temperature Control 2-2
- Ventilation for Wall Mounting 2-2
- Ventilation for Desktop Mounting 2-2
- Distance Limitations for Interface Cables 2-2
  - Fast Ethernet Maximum Distance 2-3
  - FXS Analog Voice Port Maximum Distance 2-3
  - Interference Considerations 2-3

**CHAPTER 3**

**Installing the Voice Gateway 3-1**

- Safety Recommendations 3-1
  - Maintaining Safety with Electricity 3-1
  - General Safety Practices 3-2
  - Safety Tips 3-2
  - Preventing Electrostatic Discharge Damage 3-2
- Site Log 3-3
- Installation Checklist 3-3
- Mounting Tools and Equipment 3-4
- Unpacking and Inspection 3-4
- Mounting the Chassis onto a Wall 3-5
- Setting the Chassis on a Desktop 3-7
- Installing the Ground Connection 3-7
- Connecting Cables 3-9
  - Warnings 3-9
  - Connecting Input Power to the Chassis 3-10
  - Connecting a Terminal or PC to the Console Port 3-10
  - Connecting an FXS Line 3-11

**CHAPTER 4**

**Powering On the Voice Gateway and Performing the Initial Configuration 4-1**

- Powering On the Voice Gateway 4-1
- Performing the Initial Configuration 4-2
  - Using the Cisco IOS CLI to Configure the Voice Gateway 4-2
  - Using the setup Command to Configure the Voice Gateway 4-3
  - Verifying and Saving Your Configuration 4-5
- Troubleshooting 4-6

**INDEX**



# Preface

---

- [Audience, page v](#)
- [Documentation Conventions, page v](#)
- [Accessibility, page vi](#)
- [Related Documentation, page vi](#)
- [Obtaining Documentation and Submitting a Service Request, page vii](#)
- [Safety Warnings, page vii](#)

## Audience

This document is designed for administrators who have some experience installing networking equipment such as routers, servers, and switches. You should be familiar with networks, telephony equipment, electronic circuitry, and wiring practices, and you must have experience as an electronic or electromechanical technician.



**Warning**

---

**Only trained and qualified personnel should be allowed to install, replace, or service this equipment.**  
Statement 1030

---

## Documentation Conventions

**Table 1**      *Documentation Conventions*

<b>Convention</b>	<b>Description</b>
<b>boldface font</b>	Commands and keywords.
<i>italic font</i>	Variables for which you supply values.
[   ]	Keywords or arguments that appear within square brackets are optional.
{x   y   z}	A choice of required keywords appears in braces separated by vertical bars. You must select one.
screen font	Examples of information displayed on the screen.
<b>boldface screen font</b>	Examples of information you must enter.

**Table 1**      **Documentation Conventions (continued)**

Convention	Description
< >	Nonprinting characters, for example passwords, appear in angle brackets in contexts where italic font is not available.
[ ]	Default responses to system prompts appear in square brackets.



**Note**

Means *reader take note*. Notes contain helpful suggestions or references to materials not contained in this publication.



**Timesaver**

Means *the described action saves time*. You can save time by performing the action described in the paragraph.



**Caution**

Means *reader be careful*. In this situation, you might do something that could result in equipment damage or loss of data.



**Tip**

Means *the following information will help you solve a problem*. The tips information might not be troubleshooting or even an action, but could be useful information, similar to a Timesaver.

## Accessibility

You can configure the Cisco VG202, Cisco VG202XM, Cisco VG204, and Cisco VG204XM voice gateways by using the Cisco command-line interface (CLI). The CLI conforms to code 508 because it is text based and relies on a keyboard for navigation. You can configure and monitor all functions of the voice gateway through the CLI.

For a complete list of guidelines and Cisco products' adherence to accessibility, see Cisco Accessibility Products at the following URL:

<http://www.cisco.com/web/about/responsibility/accessibility/products>

## Related Documentation

The Cisco IOS software running your Cisco voice gateway includes extensive features and functionality. For information that is beyond the scope of this document, or for additional information, use the resources listed below:

- [Cisco VG202, Cisco VG202XM, Cisco VG204, and Cisco VG204XM Voice Gateways Hardware Installation Guide](#) (this document)
- [Cisco VG202, Cisco VG202XM, Cisco VG204, and Cisco VG204XM Voice Gateways Quick Start Guide](#)

- [Cisco VG202, Cisco VG202XM, Cisco VG204, and Cisco VG204XM Voice Gateways Software Configuration Guide](#)
- [Regulatory Compliance and Safety Information for the Cisco VG202, Cisco VG202XM, Cisco VG204, and Cisco VG204XM Voice Gateways](#)



Timesaver

---

Make sure that you have access to the documents listed above. See the “[Obtaining Documentation and Submitting a Service Request](#)” section on page vii for information about obtaining these documents.

---

## Obtaining Documentation and Submitting a Service Request

For information on obtaining documentation, submitting a service request, and gathering additional information, see the monthly *What’s New in Cisco Product Documentation*, which also lists all new and revised Cisco technical documentation, at:

<http://www.cisco.com/en/US/docs/general/whatsnew/whatsnew.html>

Subscribe to the *What’s New in Cisco Product Documentation* as a Really Simple Syndication (RSS) feed and set content to be delivered directly to your desktop using a reader application. The RSS feeds are a free service and Cisco currently supports RSS version 2.0.

## Safety Warnings

Safety warnings appear throughout this document in procedures that, if performed incorrectly, may harm you. A warning symbol precedes each warning statement. To see translations of the warnings that appear in this publication, see the [Regulatory Compliance and Safety Information for the Cisco VG202, Cisco VG202XM, Cisco VG204, and Cisco VG204XM Voice Gateways](#).

## Warning Definition



Warning

---

### IMPORTANT SAFETY INSTRUCTIONS

**This warning symbol means danger. You are in a situation that could cause bodily injury. Before you work on any equipment, be aware of the hazards involved with electrical circuitry and be familiar with standard practices for preventing accidents. To see translations of the warnings that appear in**

this publication, see the translated safety warnings that accompanied this device. Statement 1071

## SAVE THESE INSTRUCTIONS

---

Waarschuwing	<p><b>BELANGRIJKE VEILIGHEIDSINSTRUCTIES</b></p> <p>Dit waarschuwingssymbool betekent gevaar. U verkeert in een situatie die lichamelijk letsel kan veroorzaken. Voordat u aan enige apparatuur gaat werken, dient u zich bewust te zijn van de bij elektrische schakelingen betrokken risico's en dient u op de hoogte te zijn van de standaard praktijken om ongelukken te voorkomen. Voor een vertaling van de waarschuwingen die in deze publicatie verschijnen, dient u de vertaalde veiligheidswaarschuwingen te raadplegen die bij dit apparaat worden geleverd.</p> <p><b>Opmerking BEWAAR DEZE INSTRUCTIES.</b></p>
Varoitus	<p><b>TÄRKEITÄ TURVALLISUUTEEN LIITTYVIÄ OHJEITA</b></p> <p>Tämä varoitusmerkki merkitsee vaaraa. Olet tilanteessa, joka voi johtaa ruumiinvammaan. Ennen kuin työskentelet minkään laitteiston parissa, ota selvää sähkökytkentöihin liittyvistä vaaroista ja tavanomaisista onnettomuuksien ehkäisykeinoista. Tässä asiakirjassa esitettyjen varoitusten käännökset löydät laitteen mukana toimitetuista ohjeista.</p> <p><b>Huomautus SÄILYTÄ NÄMÄ OHJEET</b></p>
Attention	<p><b>IMPORTANTES INFORMATIONS DE SÉCURITÉ</b></p> <p>Ce symbole d'avertissement indique un danger. Vous vous trouvez dans une situation pouvant causer des blessures ou des dommages corporels. Avant de travailler sur un équipement, soyez conscient des dangers posés par les circuits électriques et familiarisez-vous avec les procédures couramment utilisées pour éviter les accidents. Pour prendre connaissance des traductions d'avertissements figurant dans cette publication, consultez les consignes de sécurité traduites qui accompagnent cet appareil.</p> <p><b>Remarque CONSERVEZ CES INFORMATIONS</b></p>
Warnung	<p><b>WICHTIGE SICHERHEITSANWEISUNGEN</b></p> <p>Dieses Warnsymbol bedeutet Gefahr. Sie befinden sich in einer Situation, die zu einer Körperverletzung führen könnte. Bevor Sie mit der Arbeit an irgendeinem Gerät beginnen, seien Sie sich der mit elektrischen Stromkreisen verbundenen Gefahren und der Standardpraktiken zur Vermeidung von Unfällen bewusst. Übersetzungen der in dieser Veröffentlichung enthaltenen Warnhinweise sind im Lieferumfang des Geräts enthalten.</p> <p><b>Hinweis BEWAHREN SIE DIESE SICHERHEITSANWEISUNGEN AUF</b></p>
Avvertenza	<p><b>IMPORTANTI ISTRUZIONI SULLA SICUREZZA</b></p> <p>Questo simbolo di avvertenza indica un pericolo. La situazione potrebbe causare infortuni alle persone. Prima di intervenire su qualsiasi apparecchiatura, occorre essere al corrente dei pericoli relativi ai circuiti elettrici e conoscere le procedure standard per la prevenzione di incidenti. Per le traduzioni delle avvertenze riportate in questo documento, vedere le avvertenze di sicurezza che accompagnano questo dispositivo.</p> <p><b>Nota CONSERVARE QUESTE ISTRUZIONI</b></p>



**Advarsel VIKTIGE SIKKERHETSINSTRUKSJONER**

Dette varselssymbolet betyr fare. Du befinner deg i en situasjon som kan forårsake personskade. Før du utfører arbeid med utstyret, bør du være oppmerksom på farene som er forbundet med elektriske kretssystemer, og du bør være kjent med vanlig praksis for å unngå ulykker. For å se oversettelser av advarslene i denne publikasjonen, se de oversatte sikkerhetsvarslene som følger med denne enheten.

**Merk TA VARE PÅ DISSE INSTRUKSJONENE**

**Aviso INSTRUÇÕES IMPORTANTES DE SEGURANÇA**

Este símbolo de aviso significa perigo. O utilizador encontra-se numa situação que poderá ser causadora de lesões corporais. Antes de iniciar a utilização de qualquer equipamento, tenha em atenção os perigos envolvidos no manuseamento de circuitos eléctricos e familiarize-se com as práticas habituais de prevenção de acidentes. Para ver traduções dos avisos incluídos nesta publicação, consulte os avisos de segurança traduzidos que acompanham este dispositivo.

**Nota GUARDE ESTAS INSTRUÇÕES**

**¡Advertencia! INSTRUCCIONES IMPORTANTES DE SEGURIDAD**

Este símbolo de aviso indica peligro. Existe riesgo para su integridad física. Antes de manipular cualquier equipo, considere los riesgos de la corriente eléctrica y familiarícese con los procedimientos estándar de prevención de accidentes. Vea las traducciones de las advertencias que acompañan a este dispositivo.

**Nota GUARDE ESTAS INSTRUCCIONES**

**Varning! VIKTIGA SÄKERHETSANVISNINGAR**

Denna varningssignal signalerar fara. Du befinner dig i en situation som kan leda till personskada. Innan du utför arbete på någon utrustning måste du vara medveten om farorna med elkretsar och känna till vanliga förfaranden för att förebygga olyckor. Se översättningarna av de varningsmeddelanden som finns i denna publikation, och se de översatta säkerhetsvarningarna som medföljer denna anordning.

**OBS! SPARA DESSA ANVISNINGAR**

**Figyelem FONTOS BIZTONSÁGI ELOÍRÁSOK**

Ez a figyelmeztető jel veszélyre utal. Sérülésveszélyt rejtő helyzetben van. Mielőtt bármely berendezésen munkát végezte, legyen figyelemmel az elektromos áramkörök okozta kockázatokra, és ismerkedjen meg a szokásos balesetvédelmi eljárásokkal. A kiadványban szereplő figyelmeztetések fordítása a készülékhez mellékelte biztonsági figyelmeztetések között található; a fordítás az egyes figyelmeztetések végén látható szám alapján kereshető meg.

**ORIZZE MEG EZEKET AZ UTASÍTÁSOKAT!**

**Предупреждение ВАЖНЫЕ ИНСТРУКЦИИ ПО СОБЛЮДЕНИЮ ТЕХНИКИ БЕЗОПАСНОСТИ**

Этот символ предупреждения обозначает опасность. То есть имеет место ситуация, в которой следует опасаться телесных повреждений. Перед эксплуатацией оборудования выясните, каким опасностям может подвергаться пользователь при использовании электрических цепей, и ознакомьтесь с правилами техники безопасности для предотвращения возможных несчастных случаев. Воспользуйтесь номером заявления, приведенным в конце каждого предупреждения, чтобы найти его переведенный вариант в переводе предупреждений по безопасности, прилагаемом к данному устройству.

**СОХРАНИТЕ ЭТИ ИНСТРУКЦИИ**

**警告 重要的安全性说明**

此警告符号代表危险。您正处于可能受到严重伤害的工作环境中。在您使用设备开始工作之前，必须充分意识到触电的危险，并熟练掌握防止事故发生的标准工作程序。请根据每项警告结尾提供的声明号码来找到此设备的安全性警告说明的翻译文本。

请保存这些安全性说明

**警告 安全上の重要な注意事項**

「危険」の意味です。人身事故を予防するための注意事項が記述されています。装置の取り扱い作業を行うときは、電気回路の危険性に注意し、一般的な事故防止策に留意してください。警告の各国語版は、各注意事項の番号を基に、装置に付属の「Translated Safety Warnings」を参照してください。

これらの注意事項を保管しておいてください。

**주의 중요 안전 지침**

이 경고 기호는 위험을 나타냅니다. 작업자가 신체 부상을 일으킬 수 있는 위험한 환경에 있습니다. 장비에 작업을 수행하기 전에 전기 회로와 관련된 위험을 숙지하고 표준 작업 관례를 숙지하여 사고를 방지하십시오. 각 경고의 마지막 부분에 있는 경고문 번호를 참조하여 이 장치와 함께 제공되는 번역된 안전 경고문에서 해당 번역문을 찾으십시오.

이 지시 사항을 보관하십시오.

**Aviso INSTRUÇÕES IMPORTANTES DE SEGURANÇA**

**Este símbolo de aviso significa perigo. Você se encontra em uma situação em que há risco de lesões corporais. Antes de trabalhar com qualquer equipamento, esteja ciente dos riscos que envolvem os circuitos elétricos e familiarize-se com as práticas padrão de prevenção de acidentes. Use o número da declaração fornecido ao final de cada aviso para localizar sua tradução nos avisos de segurança traduzidos que acompanham o dispositivo.**

**GUARDE ESTAS INSTRUÇÕES**

**Advarsel VIGTIGE SIKKERHEDSANVISNINGER**

**Dette advarselssymbol betyder fare. Du befinder dig i en situation med risiko for legemesbeskadigelse. Før du begynder arbejde på udstyr, skal du være opmærksom på de involverede risici, der er ved elektriske kredsløb, og du skal sætte dig ind i standardprocedurer til undgåelse af ulykker. Brug erklæringsnummeret efter hver advarsel for at finde oversættelsen i de oversatte advarsler, der fulgte med denne enhed.**

**GEM DISSE ANVISNINGER**

تحذير

إرشادات الأمان الهامة

يوضح رمز التحذير هذا وجود خطر. وهذا يعني أنك متواجد في مكان قد ينتج عنه التعرض للإصابات. قبل بدء العمل، احذر مخاطر التعرض للصدمات الكهربائية وكن على علم بالإجراءات القياسية للحيلولة دون وقوع أي حوادث. استخدم رقم البيان الموجود في أحر كل تحذير لتحديد مكان ترجمته داخل تحذيرات الأمان المترجمة التي تأتي مع الجهاز. قم بحفظ هذه الإرشادات

**Upozorenje VAŽNE SIGURNOSNE NAPOMENE**

**Ovaj simbol upozorenja predstavlja opasnost. Nalazite se u situaciji koja može prouzročiti tjelesne ozljede. Prije rada s bilo kojim uređajem, morate razumjeti opasnosti vezane uz električne sklopove, te biti upoznati sa standardnim načinima izbjegavanja nesreća. U prevedenim sigurnosnim upozorenjima, priloženima uz uređaj, možete prema broju koji se nalazi uz pojedino upozorenje pronaći i njegov prijevod.**

**SAČUVAJTE OVE UPUTE**

**Upozornění DŮLEŽITÉ BEZPEČNOSTNÍ POKYNY**

**Tento upozorňující symbol označuje nebezpečí. Jste v situaci, která by mohla způsobit nebezpečí úrazu. Před prací na jakémkoliv vybavení si uvědomte nebezpečí související s elektrickými obvody a seznamte se se standardními opatřeními pro předcházení úrazům. Podle čísla na konci každého upozornění vyhledejte jeho překlad v přeložených bezpečnostních upozorněních, která jsou přiložena k zařízení.**

**USCHOVEJTE TYTO POKYNY**

**Προειδοποίηση ΣΗΜΑΝΤΙΚΕΣ ΟΔΗΓΙΕΣ ΑΣΦΑΛΕΙΑΣ**

**Αυτό το προειδοποιητικό σύμβολο σημαίνει κίνδυνο. Βρίσκεστε σε κατάσταση που μπορεί να προκαλέσει τραυματισμό. Πριν εργαστείτε σε οποιοδήποτε εξοπλισμό, να έχετε υπόψη σας τους κινδύνους που σχετίζονται με τα ηλεκτρικά κυκλώματα και να έχετε εξοικειωθεί με τις συνήθεις πρακτικές για την αποφυγή ατυχημάτων. Χρησιμοποιήστε τον αριθμό δήλωσης που παρέχεται στο τέλος κάθε προειδοποίησης, για να εντοπίσετε τη μετάφρασή της στις μεταφρασμένες προειδοποιήσεις ασφαλείας που συνοδεύουν τη συσκευή.**

**ΦΥΛΑΞΤΕ ΑΥΤΕΣ ΤΙΣ ΟΔΗΓΙΕΣ**

אזהרה

## הוראות בטיחות חשובות

סימן אזהרה זה מסמל סכנה. אתה נמצא במצב העלול לגרום לפציעה. לפני שתעבוד עם ציוד כלשהו, עליך להיות מודע לסכנות הכרוכות במעגלים חשמליים ולהכיר את הנהלים המקובלים למניעת תאונות. השתמש במספר ההוראה המסופק בסופה של כל אזהרה כדי לאתר את התרגום באזהרות הבטיחות המתורגמות שמצורפות להתקן.

## שמור הוראות אלה

Opomena

### ВАЖНИ БЕЗБЕДНОСНИ НАПАТСТВИЈА

Симболот за предупредување значи опасност. Се наоѓате во ситуација што може да предизвика телесни повреди. Пред да работите со опремата, бидете свесни за ризикот што постои кај електричните кола и треба да ги познавате стандардните постапки за спречување на несреќни случаи. Искористете го бројот на изјавата што се наоѓа на крајот на секое предупредување за да го најдете неговиот период во преведените безбедносни предупредувања што се испорачани со уредот. ЧУВАЈТЕ ГИ ОБИЕ НАПАТСТВИЈА

Ostrzeżenie

### WAŻNE INSTRUKCJE DOTYCZĄCE BEZPIECZEŃSTWA

Ten symbol ostrzeżenia oznacza niebezpieczeństwo. Zachodzi sytuacja, która może powodować obrażenia ciała. Przed przystąpieniem do prac przy urządzeniach należy zapoznać się z zagrożeniami związanymi z układami elektrycznymi oraz ze standardowymi środkami zapobiegania wypadkom. Na końcu każdego ostrzeżenia podano numer, na podstawie którego można odszukać tłumaczenie tego ostrzeżenia w dołączonym do urządzenia dokumencie z tłumaczeniami ostrzeżeń.

### NINIEJSZE INSTRUKCJE NALEŻY ZACHOWAĆ

Upozornenie

### DÔLEŽITÉ BEZPEČNOSTNÉ POKYNY

Tento varovný symbol označuje nebezpečenstvo. Nachádzate sa v situácii s nebezpečenstvom úrazu. Pred prácou na akomkoľvek vybavení si uvedomte nebezpečenstvo súvisiace s elektrickými obvodmi a oboznámte sa so štandardnými opatreniami na predchádzanie úrazom. Podľa čísla na konci každého upozornenia vyhľadajte jeho preklad v preložených bezpečnostných upozorneniach, ktoré sú priložené k zariadeniu.

### USCHOVAJTE SI TENTO NÁVOD



Warning

**Only trained and qualified personnel should be allowed to install, replace, or service this equipment.**  
Statement 1030



Warning

**Do not use this product near water; for example, near a bath tub, wash bowl, kitchen sink or laundry tub, in a wet basement, or near a swimming pool.** Statement 1035

  
**Warning**

**Never install telephone jacks in wet locations unless the jack is specifically designed for wet locations.** Statement 1036

  
**Warning**

**Never touch uninsulated telephone wires or terminals unless the telephone line has been disconnected at the network interface.** Statement 1037

  
**Warning**

**Avoid using a telephone (other than a cordless type) during an electrical storm. There may be a remote risk of electric shock from lightning.** Statement 1038

  
**Warning**

**To report a gas leak, do not use a telephone in the vicinity of the leak.** Statement 1039

  
**Warning**

**Do not work on the system or connect or disconnect cables during periods of lightning activity.** Statement 1001

  
**Warning**

**Ultimate disposal of this product should be handled according to all national laws and regulations.** Statement 1040

  
**Warning**

**This equipment must be installed and maintained by service personnel as defined by AS/NZS 3260. Incorrectly connecting this equipment to a general-purpose outlet could be hazardous. The telecommunications lines must be disconnected 1) before unplugging the main power connector or 2) while the housing is open, or both.** Statement 1043





# Overview of the Cisco VG202, Cisco VG202XM, Cisco VG204, and Cisco VG204XM Voice Gateways

- [Overview, page 1-1](#)
- [Physical Description, page 1-2](#)
- [Port Numbering Conventions, page 1-6](#)
- [Interfaces and Service Capabilities, page 1-6](#)
- [Software Elements, page 1-7](#)
- [Memory, page 1-8](#)
- [Hardware and Electrical Specifications, page 1-8](#)
- [Chassis Grounding, page 1-8](#)
- [Voice Gateway Deployment, page 1-9](#)

## Overview

The Cisco VG202, Cisco VG202XM, Cisco VG204, and Cisco VG204XM voice gateways are analog voice gateways for the service provider, commercial, and enterprise unified communication markets. These voice gateways provide voice connectivity to devices such as analog phones, fax machines, and modems.

The Cisco VG202, Cisco VG202XM, Cisco VG204, and Cisco VG204XM voice gateways provide support for 2-FXS (Cisco VG202 and Cisco VG202XM) and 4-FXS (Cisco VG204 and Cisco VG204XM) ports and parity with Cisco IOS fax/modem, security, and Session Initiation Protocol (SIP) features. These voice gateways can be configured with Cisco Unified Communications Manager Express (CUCME) or Cisco Unified Communications Manager (CUCM).

The Cisco VG202, Cisco VG202XM, Cisco VG204, and Cisco VG204XM voice gateways support the following interfaces:

- 10/100 Fast Ethernet connection
- RJ-11 Foreign Exchange Station (FXS) interface
- DC input

**Note**

The Cisco VG202, Cisco VG202XM, Cisco VG204, and Cisco VG204XM voice gateways are fixed-configuration voice gateways and do not support interface cards.

## Physical Description

- [Front Panel Description, page 1-2](#)
- [Back Panel Description, page 1-3](#)
- [LEDs, page 1-4](#)
- [Product Serial Number Location, page 1-5](#)

## Front Panel Description

[Figure 1-1](#) shows the chassis of the Cisco VG202 voice gateway as seen from the front panel.

**Note**

The Cisco VG202 and the Cisco VG202XM chassis are identical. The only difference is the model number on the front right. On the Cisco VG202 chassis, the faceplate label says VG202. On the Cisco VG202XM chassis, the faceplate label says VG202XM.

**Figure 1-1** Cisco VG202 Chassis Front Panel

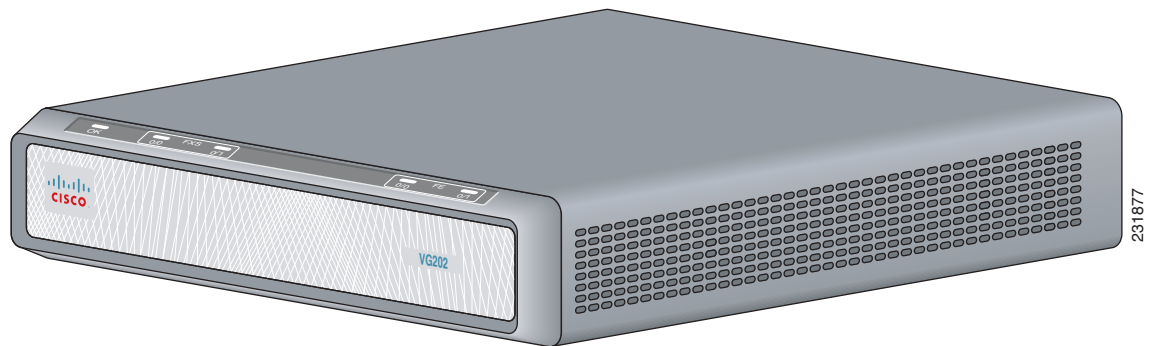

[Figure 1-2](#) shows the chassis of the Cisco VG204 voice gateway as seen from the front panel.

**Note**

The Cisco VG204 and the Cisco VG204XM chassis are identical. The only difference is the model number on the front right. On the Cisco VG204 chassis, the faceplate label says VG204. On the Cisco VG204XM chassis, the faceplate label says VG204XM.



Figure 1-2 Cisco VG204 Chassis Front Panel

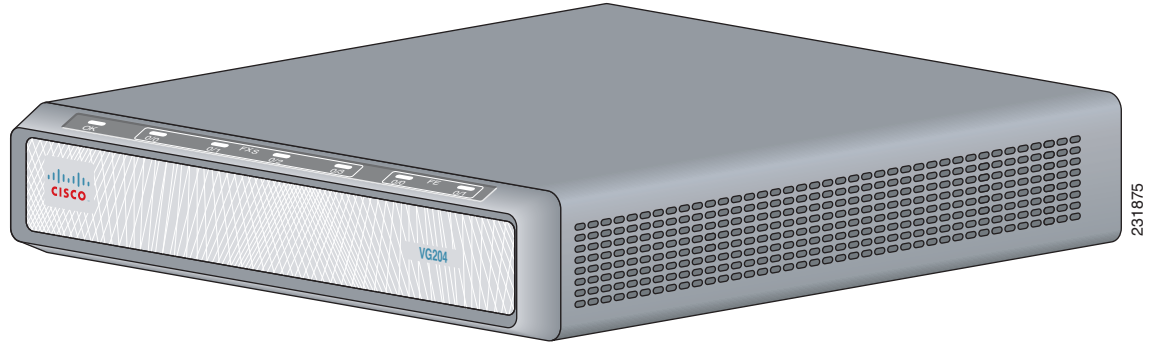

## Back Panel Description

The Cisco VG202 voice gateway supports two RJ-11 ports and supports two FXS voice ports with two 10/100 Fast Ethernet ports. Figure 1-3 shows the interfaces and ports on the Cisco VG202 voice gateway. All interface ports are on the back of the chassis.



### Note

The Cisco VG202 and the Cisco VG202XM chassis are identical. The only difference is the model number on the top center. On the Cisco VG202 chassis, the faceplate label says VG202. On the Cisco VG202XM chassis, the faceplate label says VG202XM.

Figure 1-3 Cisco VG202 Chassis Back Panel

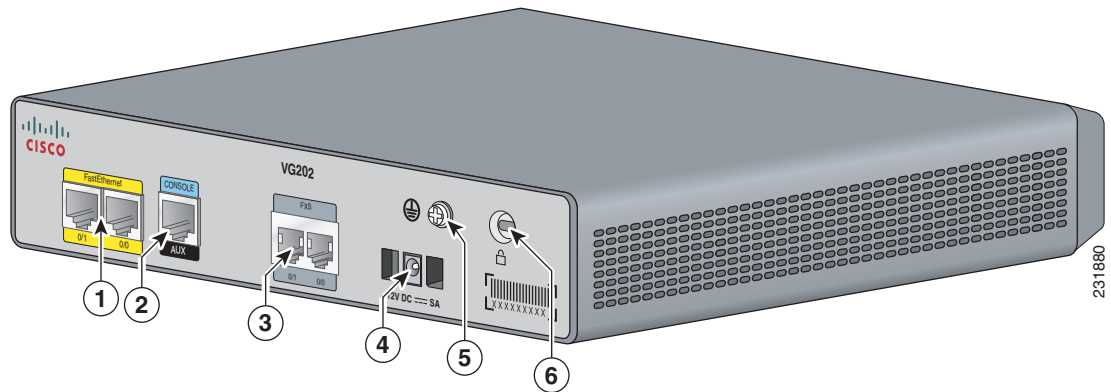

1	Fast Ethernet port 1, Fast Ethernet port 0	2	Serial port—console or auxiliary	3	FXS ports
4	Power connector	5	Chassis ground connection	6	Kensington security slot

The Cisco VG204/Cisco VG204XM voice gateway supports four RJ-11 ports and supports four FXS voice ports with two 10/100 Fast Ethernet ports. Figure 1-4 shows the interfaces and ports on the Cisco VG204/Cisco VG204XM voice gateway. All interface ports are on the back of the chassis.

**Note**

The Cisco VG204 and the Cisco VG204XM chassis are identical. The only difference is the model number on the top center. On the Cisco VG204 chassis, the faceplate label says VG204. On the Cisco VG204XM chassis, the faceplate label says VG204XM.

**Figure 1-4 Cisco VG204 Chassis Back Panel**

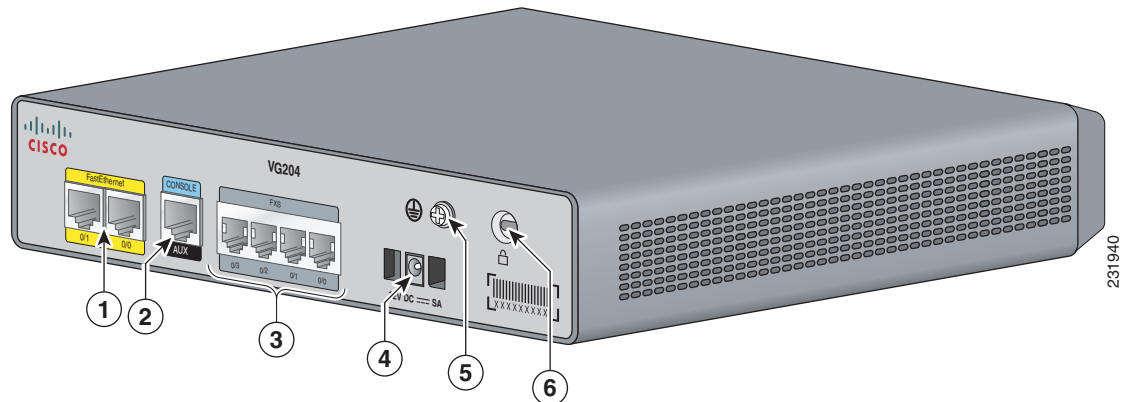

<b>1</b>	Fast Ethernet port 1, Fast Ethernet port 0	<b>2</b>	Serial port—console or auxiliary	<b>3</b>	FXS ports
<b>4</b>	Power connector	<b>5</b>	Chassis ground connection	<b>6</b>	Kensington security slot

**Note**

- A Kensington security slot is located on the back panel of the chassis. To secure the chassis to a desktop or other surface, use the Kensington lockdown equipment.
- The Fast Ethernet built-in switch ports provide connections to 10/100BASE-T (10/100-Mbps) Fast Ethernet networks.

## LEDs

For the Cisco VG202, Cisco VG202XM, Cisco VG204, and Cisco VG204XM voice gateways, the LEDs are on the front of the chassis. [Figure 1-5](#) shows the LEDs on the Cisco VG204 chassis.

**Note**

- The Cisco VG204 and the Cisco VG204XM chassis are identical. The only difference is the model number on the right. On the Cisco VG204 chassis, the faceplate label says VG204. On the Cisco VG204XM chassis, the faceplate label says VG204XM.
- LEDs on the Cisco VG202 and Cisco VG202XM chassis are the same as the LEDs on the Cisco VG204 chassis, as shown in [Figure 1-5](#) except that the chassis for the Cisco VG202 and Cisco VG202XM voice gateways only have LEDs for two FXS ports.

Figure 1-5 Cisco VG204 Chassis LEDs

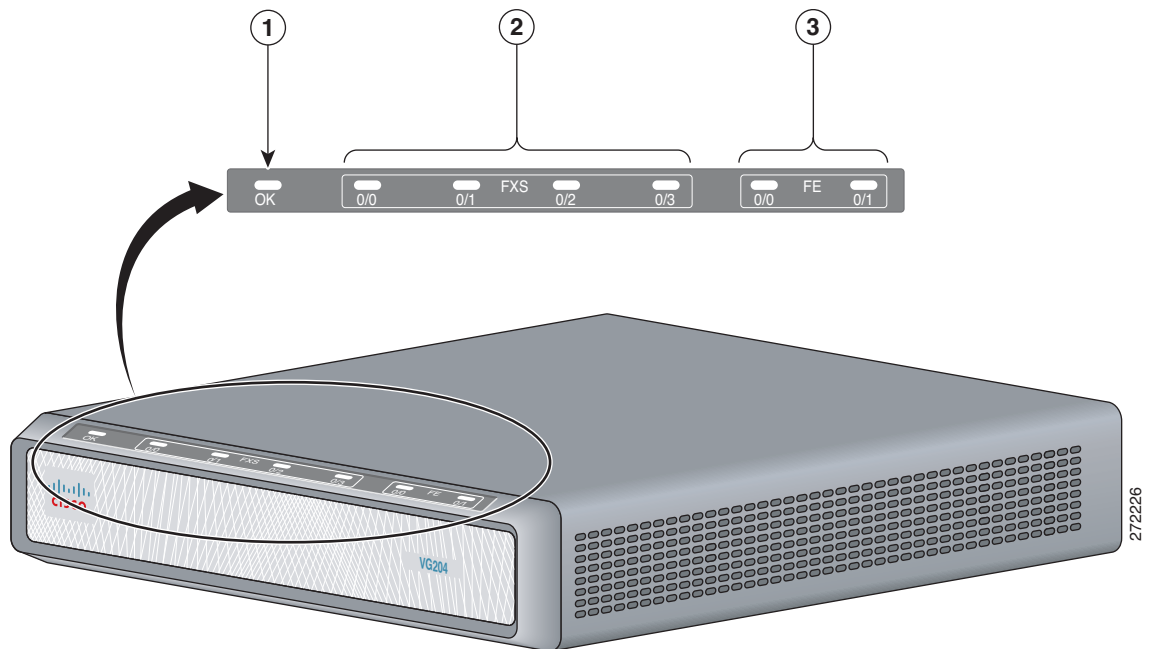

<b>1</b>	OK LED	<b>2</b>	FXS0, FXS1, FXS2, FXS3 LEDs
<b>3</b>	Fast Ethernet 0/0 and 0/1 LEDs		

Table 1-1 describes the status of each LED on the Cisco VG202, Cisco VG202XM, Cisco VG204, and Cisco VG204XM chassis.

Table 1-1 Cisco VG202, Cisco VG202XM, Cisco VG204, and Cisco VG204XM LEDs

No	LED/Color	Description
1	PWR OK—green	Off—no power Steady on—normal operation Slow blink—bootup phase or in ROMMON monitor mode
2	FXS ports 0 through 3—green	Off—On hook Steady On—Off hook
3	Fast Ethernet ports 0/1—green	Off—No link Steady on—link Blinking—TXD/RXD data

## Product Serial Number Location

The serial number label for the Cisco VG202, Cisco VG202XM, Cisco VG204, and Cisco VG204XM voice gateways is located on the bottom of the chassis, near the compliance label. The size of the serial number label is 0.25 x 1 inch (0.635 x 2.54 centimeters). It has the letters “SN:” followed by eleven characters. See Figure 1-6.

**Figure 1-6** Serial Number Location on Cisco VG202, Cisco VG202XM, Cisco VG204, and Cisco VG204XM Voice Gateways

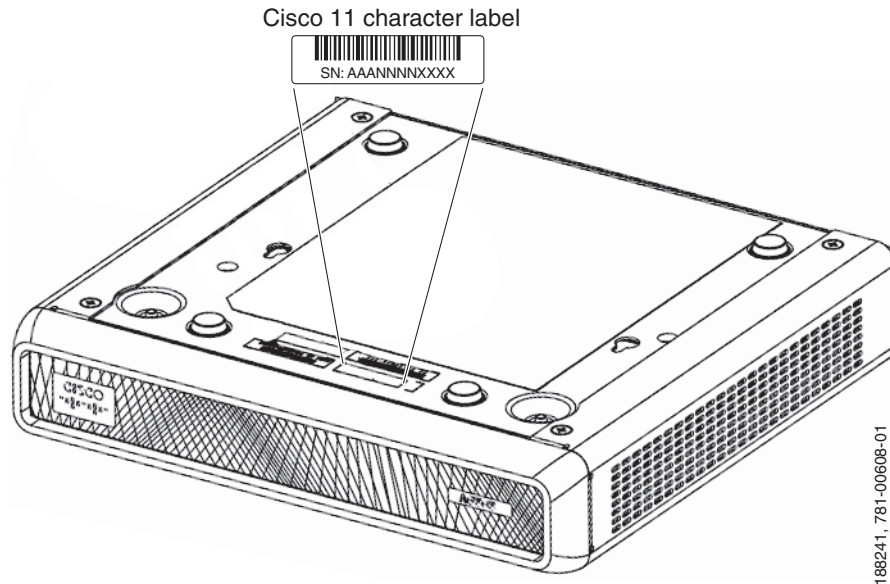

## Port Numbering Conventions

Port numbering conventions for the Cisco VG202, Cisco VG202XM, Cisco VG204, and Cisco VG204XM voice gateways are as follows:

- Fast Ethernet ports are numbered 0 and 1, from left to right.
- FXS voice port numbering begins at 0 and reaches a maximum of 2 or 4, depending on the number of voice ports, from left to right.

## Interfaces and Service Capabilities

Table 1-2 describes the physical ports and services that each port type supports, including the following:

- The Cisco VG202, Cisco VG202XM, Cisco VG204, and Cisco VG204XM voice gateways provide a connection to the terminal or PC for software configuration or troubleshooting. The console port may be configured as a virtual auxiliary port for dial backup and remote management.
- Two Fast Ethernet ports.
- Two FXS ports for the Cisco VG202 and Cisco VG202XM voice gateways and four FXS ports for the Cisco VG204 and Cisco VG204XM voice gateways.

**Table 1-2** *Cisco VG202, Cisco VG202XM, Cisco VG204, and Cisco VG204XM Voice Gateways Interfaces and Service Capabilities*

Port	Interface Configurations	Interface To	Services Supported	Details
Console/AUX Port	EIA/TIA-232 asynchronous serial (DCE)	ASCII terminal or personal computer	Local administrative access	RJ-45 physical interface
Fast Ethernet Ports 0/0, 0/1	10/100BASE-T (802.3)	LAN	Data	RJ-45 physical interface
Ports 0 to 1, or 0 to 3	FXS (loop-start or ground-start)	Analog phone, fax, or modem	Analog voice/fax or modem	2-port FXS, on premises only 4-port FXS, on premises only

[Table 1-3](#) lists the interface options that are available for the Cisco VG202, Cisco VG202XM, Cisco VG204, and Cisco VG204XM voice gateways.

**Table 1-3** *Interface Options for Cisco VG202, Cisco VG202XM, Cisco VG204, and Cisco VG204XM Voice Gateways*

Voice Gateway	RJ-11 <sup>1</sup>	RJ-45 <sup>2</sup>	FE <sup>3</sup>	FXS <sup>4</sup>
Cisco VG202 and Cisco VG202XM	2	Yes	2	2
Cisco VG204 and Cisco VG204XM	4	Yes	2	4

1. Analog voice interface.
2. Analog voice interface.
3. 10/100BASE-T ports.
4. Foreign exchange station.

## Software Elements

- [Operating System, page 1-7](#)
- [Configuration Connections, page 1-7](#)

## Operating System

The operating system for the Cisco VG202, Cisco VG202XM, Cisco VG204, and Cisco VG204XM voice gateways is the Cisco IOS software that resides in flash memory.

## Configuration Connections

You can use an ASCII terminal or a PC to configure the Cisco VG202, Cisco VG202XM, Cisco VG204, or Cisco VG204XM voice gateway. The configuration can be performed in several ways:

- Locally, with a direct connection through the serial port

- Remotely, with a connection through the serial port
- Through Telnet and TFTP

## Memory

The Cisco VG202, Cisco VG202XM, Cisco VG204, and Cisco VG204XM voice gateways contain flash memory and main memory:

- The onboard flash memory contains the 128 MB Cisco IOS software image.
- The boot flash memory contains the ROMMON boot code.
- The anti-counterfeiting solution contains the cookie configuration.

For the Cisco VG202 and Cisco VG204 voice gateways, the onboard CPU memory is 128 MB. For the Cisco VG202XM and Cisco VG204XM voice gateways, the onboard CPU memory is 256 MB.

## Hardware and Electrical Specifications

Table 1-4 shows the hardware and electrical specifications for the Cisco VG202, Cisco VG202XM, Cisco VG204, and Cisco VG204XM voice gateways.

**Table 1-4 Cisco VG202, Cisco VG202XM, Cisco VG204, and Cisco VG204XM Voice Gateway Technical Specifications**

Characteristic	Value
Dimensions	1.75H x 9.75W x 8.0D in. (44.45 x 247.65 x 203.2 mm)
Weight	3.422 lb (1.55 kg) max
Input power	30 W
Operating temperature	32 to 104 degrees F (0 to 40 degrees C)
Operating humidity	5 to 95 percent, noncondensing
Noise level	n/a
Agency approvals	See the <i>Regulatory Compliance and Safety Information for the Cisco VG202, Cisco VG202XM, Cisco VG204, and Cisco VG204XM Voice Gateways</i> document.









## Chassis Grounding

For information on grounding the chassis, see the “Installing the Ground Connection” section on page 3-7.



### Warning

**There is the danger of explosion if the battery is replaced incorrectly. Replace the battery only with the same or equivalent type recommended by the manufacturer. Dispose of used batteries according to the manufacturer's instructions.** Statement 1015

-  **Warning** This unit is intended for installation in restricted access areas. A restricted access area can be accessed only through the use of a special tool, lock and key, or other means by security. Statement 1017
-  **Warning** No user-serviceable parts inside. Do not open. Statement 1073
-  **Warning** This equipment needs to be grounded. Use a green and yellow 12 to 14 AWG ground wire to connect the host to earth ground during normal use. Statement 242
-  **Warning** The importance of proper grounding cannot be overemphasized. It will minimize the potential for damage to your system and maximize safety at the system site. We recommend you consult a licensed electrician or your local electric utility company if you have any questions. Statement 269
-  **Warning** A ground wire must always be a single piece of wire. Never splice two wires together for a ground. Corrosion and weathering can lead to a poor connection at the splice, making the ground ineffective and dangerous. Statement 270
-  **Warning** Use copper conductors only. Statement 1025
-  **Warning** Installation of the equipment must comply with local and national electrical codes. Statement 1074
-  **Warning** Ultimate disposal of this product should be handled according to all national laws and regulations. Statement 1040

## Voice Gateway Deployment

Figure 1-7 shows a typical deployment scenario for a Cisco VG202, Cisco VG202XM, Cisco VG204, or Cisco VG204XM voice gateway.

**Figure 1-7** Typical Deployment of a Cisco VG202, Cisco VG202XM, Cisco VG204, or Cisco VG204XM Voice Gateway

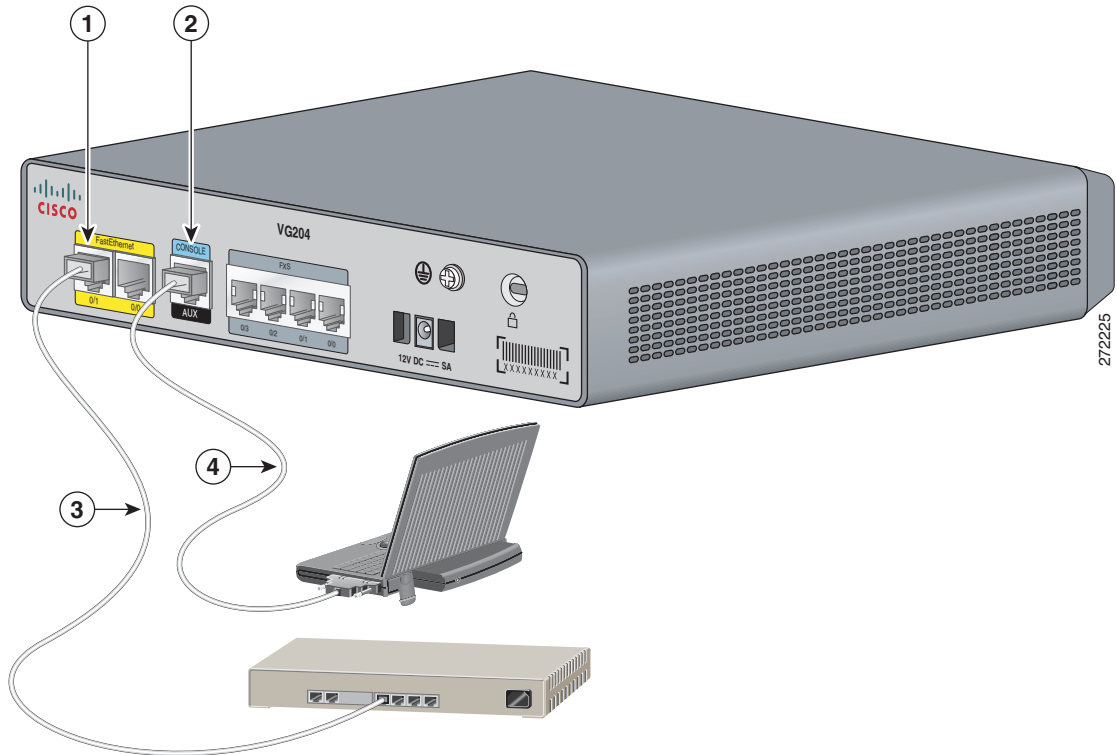

<b>1</b>	Fast Ethernet port	<b>2</b>	Console port
<b>3</b>	Fast Ethernet straight-through cable connected to an Ethernet hub	<b>4</b>	RJ-45-to-DB9 console cable connected to a PC





## Planning Your Installation

---

- [Location and Mounting Requirements, page 2-1](#)
- [Distance Limitations for Interface Cables, page 2-2](#)

### Location and Mounting Requirements

- [About Mounting Location Requirements, page 2-1](#)
- [Access to the Chassis, page 2-1](#)
- [Power Source, page 2-2](#)
- [Temperature Control and Ventilation, page 2-2](#)

### About Mounting Location Requirements

You can mount a Cisco VG202, Cisco VG202XM, Cisco VG204, or Cisco VG204XM voice gateway chassis onto either a wall or on a desk or shelf.

The mounting location must provide the following:

- Adequate access to the chassis. See [Access to the Chassis, page 2-1](#).
- Access to a suitable power source. See [Power Source, page 2-2](#).
- Allowance for adequate heat dissipation and airflow around the chassis. Inadequate ventilation can result in overheating and damage. See [Temperature Control and Ventilation, page 2-2](#).
- Access to an appropriate earth ground. See [Installing the Ground Connection, page 3-7](#).

### Access to the Chassis

Allow space at the back of the chassis for cable connections. Also consider the need to access the chassis for future upgrades, maintenance, and troubleshooting.

## Power Source



**Warning**

**Do not work on the system or connect or disconnect cables during periods of lightning activity.** Statement 1001



**Warning**

**Read the installation instructions before you connect the system to its power source.** Statement 1004



**Warning**

**This product relies on the building's installation for short-circuit (overcurrent) protection. Ensure that the protective device is rated not greater than:120 VAC, 15A U.S. (240 VAC, 10A international)** Statement 1005



**Warning**

**The device is designed for connection to TN and IT power systems.** Statement 1007

## Temperature Control and Ventilation

- [Temperature Control, page 2-2](#)
- [Ventilation for Wall Mounting, page 2-2](#)
- [Ventilation for Desktop Mounting, page 2-2](#)

### Temperature Control

The installation area (room, closet, or cabinet) for the voice gateway chassis must be well ventilated and provide adequate air circulation to ensure proper cooling. The room temperature should be maintained between 32 to 122 degrees F (0 to 50 degrees C).

### Ventilation for Wall Mounting

If you install the chassis onto a wall, ensure that there is plenty of space on all sides of the chassis to allow adequate airflow through the chassis.

### Ventilation for Desktop Mounting

If you place the chassis on a desk or shelf, do not stack other equipment or paper on top of it. Provide plenty of space for air circulation on all four sides of the chassis.

## Distance Limitations for Interface Cables

When planning your installation, consider distance limitations and potential electromagnetic interference (EMI) as defined by the Electronic Industries Association (EIA).

- [Fast Ethernet Maximum Distance, page 2-3](#)

- [FXS Analog Voice Port Maximum Distance, page 2-3](#)
- [Interference Considerations, page 2-3](#)

## Fast Ethernet Maximum Distance

The maximum segment distance for Fast Ethernet is 330 feet (100 meters) (specified in IEEE 802.3).

## FXS Analog Voice Port Maximum Distance

The maximum distance is established by a total allowable loop resistance, including the phone or terminal equipment, of 600 Ohm.

## Interference Considerations

When you run cables for any significant distance in an electromagnetic field, interference can occur between the electromagnetic field and the signals on the cables. This has two implications for the installation of terminal plant cabling:

- Unshielded plant cabling can emit radio interference.
- Strong electromagnetic interference (EMI), especially caused by lightning or radio transmitters, can destroy the EIA/TIA-232 drivers and receivers in the Cisco VG202, Cisco VG202XM, Cisco VG204, or Cisco VG204XM voice gateways.

If you use twisted-pair cables with a good distribution of grounding conductors in your plant cabling, emitted radio interference is unlikely.

If your cables exceed the recommended distances, or if your cables pass between buildings, you must give special consideration to the effect of lightning strikes or ground loops. If your site has these characteristics, consult experts in lightning suppression and shielding. The electromagnetic pulse caused by lightning or other high-energy phenomena can easily couple enough energy into unshielded conductors to destroy electronic devices.

Most data centers cannot resolve the infrequent but potentially catastrophic problems of EMI without using pulse meters and other special equipment. Take precautions to avoid these problems by providing a properly grounded and shielded environment and by installing electrical surge suppression.

If you remove any module, you must either install a module in its place or install a cover plate over the opening. To prevent electromagnetic interference, all module openings must be either occupied or covered.

For advice on the prevention of electromagnetic interference, consult experts in radio-frequency interference (RFI).





## Installing the Voice Gateway

---

- [Safety Recommendations, page 3-1](#)
- [Site Log, page 3-3](#)
- [Installation Checklist, page 3-3](#)
- [Mounting Tools and Equipment, page 3-4](#)
- [Unpacking and Inspection, page 3-4](#)
- [Mounting the Chassis onto a Wall, page 3-5](#)
- [Setting the Chassis on a Desktop, page 3-7](#)
- [Installing the Ground Connection, page 3-7](#)
- [Connecting Cables, page 3-9](#)



Tip

---

While you perform this installation, record your progress and site information. See the suggested format in the [“Installation Checklist”](#) section on [page 3-3](#).

---



Warning

---

**Read the installation instructions before connecting the system to the power source.** Statement 1004

---

## Safety Recommendations

- [Maintaining Safety with Electricity, page 3-1](#)
- [General Safety Practices, page 3-2](#)
- [Safety Tips, page 3-2](#)
- [Preventing Electrostatic Discharge Damage, page 3-2](#)

## Maintaining Safety with Electricity

Follow these guidelines when working on equipment powered by electricity.



Warning

---

**Do not work on the system or connect or disconnect cables during periods of lightning activity.**  
Statement 1001

---

**Warning**

**This equipment must be installed and maintained by service personnel as defined by AS/NZS 3260. Incorrectly connecting this equipment to a general-purpose outlet could be hazardous. The telecommunications lines must be disconnected 1) before unplugging the main power connector or 2) while the housing is open, or both.** Statement 1043

## General Safety Practices

Follow these guidelines to ensure personal safety and protect the equipment:

- Keep the chassis area clear and dust-free during and after installation.
- Put the removed chassis cover in a safe place.
- Keep tools away from walk areas where you and others could fall over them.
- Do not wear loose clothing that could get caught in the chassis.
- Wear safety glasses if you are working under any conditions that might be hazardous to your eyes.

## Safety Tips

Use these tips as safety guidelines when installing or working around this equipment:

- Locate the emergency power-off switch for the room in which you are working. Then, if an electrical accident occurs, you can act quickly to turn off the power.
- Disconnect all power before installing or removing a chassis.
- Do not work alone if potentially hazardous conditions exist.
- Never assume that power is disconnected from a circuit. Always check.
- Look carefully for possible hazards in your work area, such as moist floors, ungrounded power extension cables, and missing safety grounds.
- If an electrical accident occurs, proceed as follows:
  - Use caution; do not become a victim yourself.
  - Turn off power to the system.
  - If possible, send another person to get medical aid. Otherwise, assess the condition of the victim and then call for help.
  - Determine if the person needs rescue breathing or external cardiac compressions; then take appropriate action.

## Preventing Electrostatic Discharge Damage

Electrostatic discharge (ESD) can damage equipment and impair electrical circuitry. ESD occurs when electronic components are improperly handled; it can result in complete or intermittent failures.

Always follow ESD-prevention procedures when removing and replacing components.

- Ensure that the chassis is electrically connected to earth ground.
- Wear an ESD-preventive wrist strap, ensuring that it makes good skin contact.

- Connect the clip to the ESD-strap connection jack (to the left of the power switch on the back of the chassis) or to an unpainted chassis frame surface.

**Caution**

For safety, periodically check the resistance value of the antistatic strap, which should be between 1 and 10 megohm (Mohm).

## Site Log

We recommend that you maintain a site log to record all actions relevant to the system. Site log entries might include the following:

- Installation—Print a copy of the installation checklist and insert it into the site log.
- Upgrades and maintenance—Use the site log to record ongoing maintenance and expansion history. Update the site log to reflect the following:
  - Configuration changes
  - Maintenance schedules, requirements, and procedures performed
  - Comments, notes, and problems
  - Changes and updates to Cisco IOS software

## Installation Checklist

The installation checklist (see [Figure 3-1](#)) lists the tasks for installing a Cisco VG202, Cisco VG202XM, Cisco VG204, or Cisco VG204XM voice gateway. Print a copy of this checklist and mark the entries as you complete each task. For each voice gateway, include a copy of the checklist in your site log.

**Figure 3-1**      **Installation Checklist**

Installation checklist for site \_\_\_\_\_

Cisco VG name/serial number \_\_\_\_\_

Task	Verified by	Date
Background information placed in site log		
Environmental specifications verified		
Site power voltages verified		
Installation site prepower check completed		
Required tools available		
Additional equipment available		
Voice gateway received		
Quick Start Guide received		
Regulatory Compliance and Safety Information received		
Information packet, warranty card, and Cisco.com card received		

Task	Verified by	Date
Software version verified		
Rack, desktop, or wall-mounting of voice gateway completed		
Initial electrical connections established		
ASCII terminal attached to console port		
Modem attached to console port (for remote configuration)		
Signal distance limits verified		
Startup sequence steps completed		
Initial operation verified		

## Mounting Tools and Equipment

Obtain the following tools and parts to install your voice gateway:

- Screws and anchors for mounting the chassis on the wall. You need eight wood screws or other fasteners. You can use an additional starter screw to facilitate the wall-mounting.
- ESD-preventive wrist strap

In addition, you might need the following external equipment:

- Console terminal or personal computer with terminal emulation software for administrative access
- Modem for remote access
- Analog voice RJ-11 cable

## Unpacking and Inspection

Do not unpack the Cisco VG202, Cisco VG202XM, Cisco VG204, or Cisco VG204XM voice gateway until you are ready to install the equipment. If the installation site is not ready, keep the voice gateway in its shipping container to prevent accidental damage.

The voice gateway, cables, and any optional equipment that you ordered might be shipped in more than one box. When you unpack each shipping container, check the packing list to ensure that you received all the following items:

- Cisco VG202, Cisco VG202XM, Cisco VG204, or Cisco VG204XM voice gateway
- Power cord, 6 feet (1.8-meters long)
- RJ-45-to-DB-25 adapter cable (labeled *Console*)
- Grounding lug and fasteners

Inspect all items for shipping damage. If anything appears damaged, or if you encounter problems when installing or configuring your system, contact a customer service representative. (See the [“Obtaining Documentation and Submitting a Service Request”](#) section on page vii.)



# Mounting the Chassis onto a Wall

The following warning applies only when the voice gateway chassis is mounted on a wall:



**Warning**

**This unit is intended to be mounted on a wall. Please read the wall-mounting instructions carefully before beginning installation. Failure to use the correct hardware or to follow the correct procedures could result in a hazardous situation to people and damage to the system.** Statement 248

You can mount the chassis onto a wall or other vertical surface by using the molded mounting-screw slots on the bottom of the chassis and two number-six, 3/4 inch (M3.5 x 20 mm) screws. You must provide the screws. [Figure 3-2](#) shows the mounting-screw slots.

**Figure 3-2** *Mounting-Screw Slots for Mounting a Cisco VG202, Cisco VG202XM, Cisco VG204, or Cisco VG204XM Voice Gateway Chassis onto a Wall*

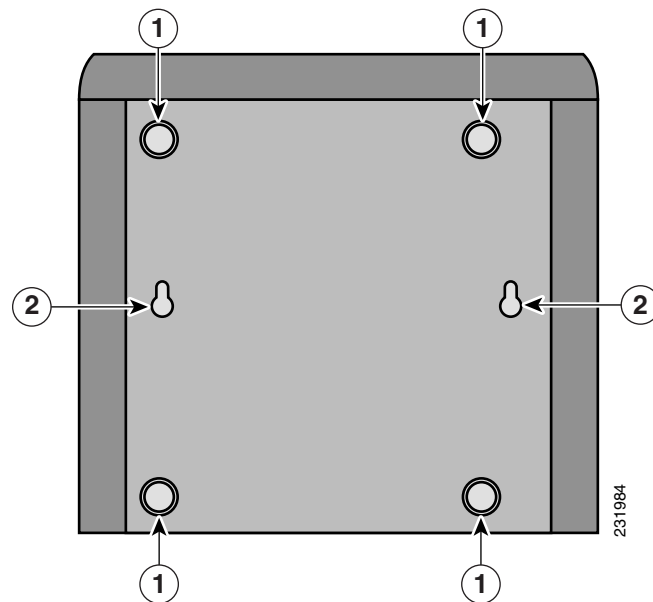

<b>1</b>	Rubber feet	<b>2</b>	Mounting-screw slots
----------	-------------	----------	----------------------

## Before You Begin

Ensure that you meet the following conditions when you mount the chassis onto a wall:

- The LEDs on the front panel face upward and are easily visible, because you will use the LEDs as status and problem indicators.
- The back panel faces downward, to reduce strain on the cable connections.
- The power supply rests on a horizontal surface such as the floor or a table. If the power supply is not supported, it can place strain on the power supply cable and cause it to disconnect from the connector on the back panel of the chassis.

**Procedure**

- Step 1** Secure two screws 5 7/16 in (13.81 cm) apart into a wall and 5/32 in (0.40 cm) out from the wall.
- Step 2** Hang the chassis on the screws as shown in [Figure 3-3](#).

**Figure 3-3** *Mounting the Cisco VG202, Cisco VG202XM, Cisco VG204, or Cisco VG204XM Voice Gateway Chassis onto a Wall*

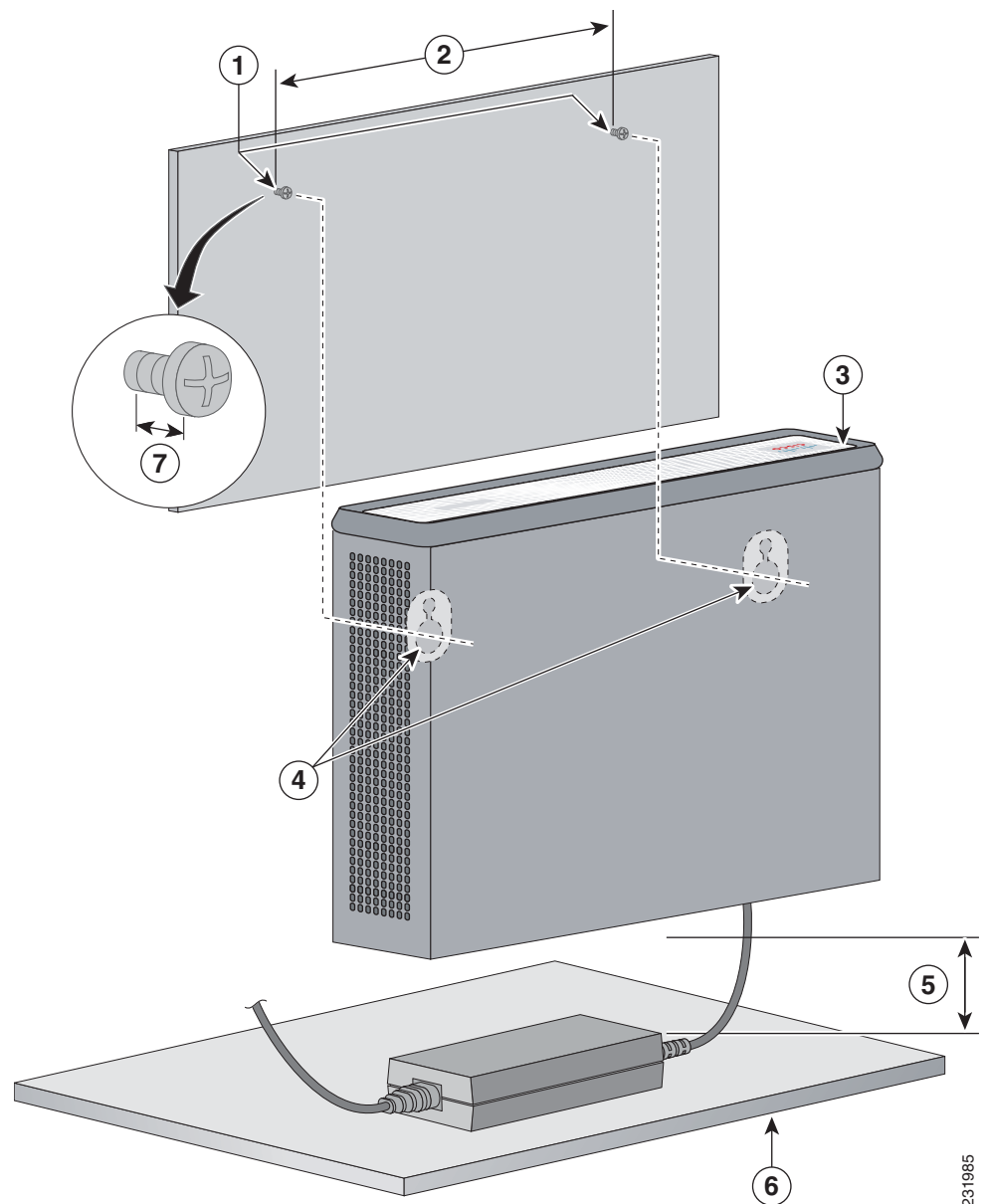

<b>1</b>	Two number-six, 3/4-in. screws	<b>2</b>	Distance between the two screws (5 7/16 in. [13.8 cm])
<b>3</b>	Voice gateway	<b>4</b>	Mounting-screw slots
<b>5</b>	Maximum distance between the voice gateway and the power supply (6 ft [1.8 m])	<b>6</b>	Horizontal surface on which to place the power supply
<b>7</b>	Distance between the screw and the wall (5/32 in. [0.40 cm])		

**Step 3** Place the power supply on a horizontal surface.



**Caution**

If you are mounting the voice gateway on drywall, use hollow-wall anchors (1/8 inch with 5/16-inch drill bit, or M3 with 8-mm drill bit) to secure the screws. If the screws are not properly anchored, the strain of the network cable connections could pull the voice gateway from the wall. Use two wall anchors with washers. Wall anchors and washers must be size number 10.

## Setting the Chassis on a Desktop

You can place the voice gateway chassis on a desktop or shelf.



**Caution**

Do not place anything on top of the chassis that weighs more than 10 lb (4.5 kg). Excessive weight on top can damage the chassis.

### Procedure

**Step 1** Place the four rubber feet (from the accessory kit) in the four indentations on the underside of the chassis. This helps provide proper airflow through and around the chassis.

**Step 2** Place the chassis onto a smooth, flat surface.

## Installing the Ground Connection

You must connect the chassis to a reliable earth ground; the ground wire must be installed in accordance with local electrical safety standards.

- For NEC-compliant grounding, use size AWG 14 (2 mm<sup>2</sup>) or larger wire and an appropriate user-supplied ring terminal.
- For EN/IEC 60950-compliant grounding, use size AWG 18 (1 mm<sup>2</sup>) or larger wire and an appropriate user-supplied ring terminal.

**Warning**

**This equipment must be grounded. Never defeat the ground conductor or operate the equipment in the absence of a suitably installed ground conductor. Contact the appropriate electrical inspection authority or an electrician if you are uncertain that suitable grounding is available.** Statement 1024

**Warning**

**Use copper conductors only.** Statement 1025

**Before You Begin**

Locate a suitable ground.

**Tip**

Using a multimeter, measure the resistance between various possible ground locations, such as between the ground of a junction box (outlet) and the ground of a power tap, between the ground of a junction box and a metal water pipe, between the chassis and the ground of a power tap, and between the chassis and the ground of a junction box. A good ground connection should read between 0.0 and 0.5 Ohm.

**Procedure**

- Step 1** Strip one end of the ground wire to the length required for the ring terminal.
- Step 2** Crimp the ground wire to the ground lug or ring terminal, using a crimp tool of the appropriate size. (See [Figure 3-4](#).)

**Figure 3-4** *Crimping a Ground Lug onto the Ground Wire*

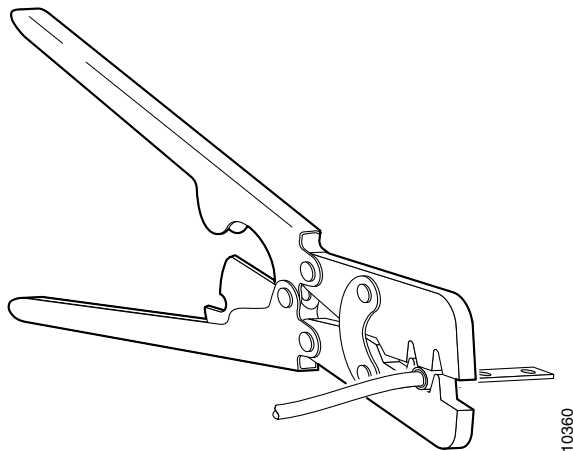

- Step 3** Attach the ring terminal to the chassis as shown in [Figure 3-5](#). For a ring terminal, use one of the screws provided. Use a number 2 Phillips screwdriver to tighten the screws to a torque of 8 to 10 in-lb (0.9 to 1.1 N-m).
- Step 4** Connect the other end of the ground wire to a grounding point at your site.

**Figure 3-5** Chassis Ground Connection Using Ring Terminal

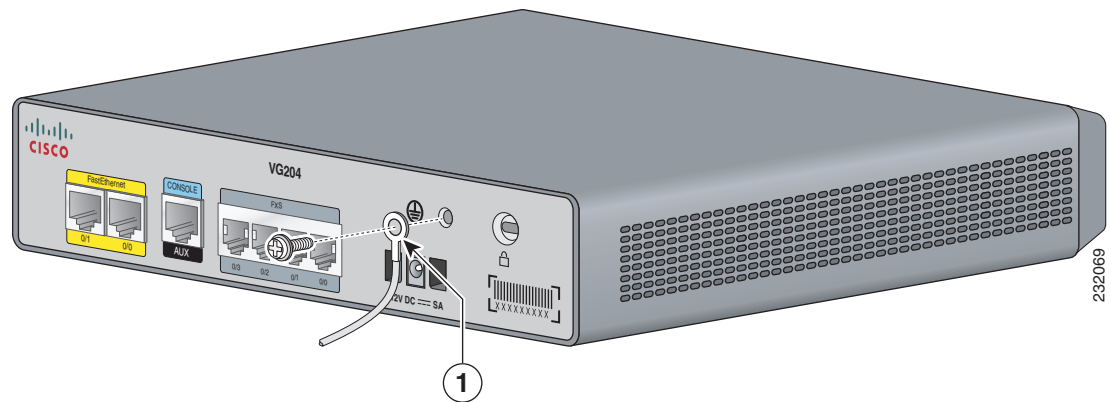

<b>1</b>	Ring terminal attachment
----------	--------------------------

## Connecting Cables

- [Warnings, page 3-9](#)
- [Connecting Input Power to the Chassis, page 3-10](#)
- [Connecting a Terminal or PC to the Console Port, page 3-10](#)
- [Connecting an FXS Line, page 3-11](#)

## Warnings



**Warning**

**Do not work on the system or connect or disconnect cables during periods of lightning activity.**  
Statement 1001



**Warning**

**Take care when connecting units to the supply circuit so that wiring is not overloaded.** Statement 1018



**Warning**

**This product relies on the building's installation for short-circuit (overcurrent) protection. Ensure that the protective device is rated not greater than: 120 VAC, 15A (240 VAC, 10A international)**  
Statement 1005



**Warning**

**To prevent accidental discharge in the event of a power line cross, route on-premise wiring away from power cables and off-premise wiring, or use a grounded shield to separate the on-premise wiring from the power cables and off-premise wiring. A power line cross is an event, such as a lightning strike, that causes a power surge. Off-premise wiring is designed to withstand power line**

crosses. On-premise wiring is protected from power line crosses by a device that provides overcurrent and overvoltage protection. Nevertheless, if the on-premise wiring is in close proximity to, or not shielded from, the off-premise wiring or power cables during a lightning strike or power surge, the on-premise wiring can carry a dangerous discharge to the attached interface, equipment, and nearby personnel. Statement 338

## Connecting Input Power to the Chassis

### Procedure

**Step 1** Connect the chassis to an AC power outlet as shown in [Figure 3-6](#).

**Figure 3-6** Connecting the External Power Supply to the Cisco Voice Gateway

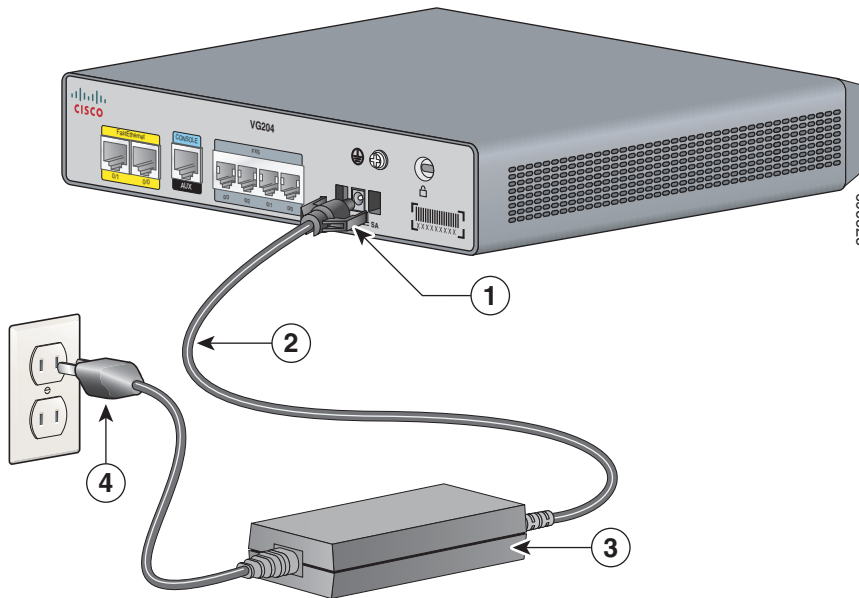

<b>1</b>	Power lock clip	<b>2</b>	Power cord
<b>3</b>	Power adapter	<b>4</b>	AC plug

**Step 2** To secure the power cord to the voice gateway, attach the power lock clip to the power cord, and slide the clip to the end of the DC plug. See location 1 in [Figure 3-6](#).

## Connecting a Terminal or PC to the Console Port

Connect a terminal or PC to the Console Aux port either to configure the software by using the command-line interface (CLI) or to troubleshoot problems with the voice gateway.

**Procedure**

- Step 1** Connect the RJ-45 end of a DB-9-to-RJ-45 serial cable to the RJ-45 Console Aux port on the chassis. [Figure 3-7](#) shows the RJ-45 end of the serial cable connected to the Console Aux port on the chassis.

**Figure 3-7** Connecting a Terminal or PC to the Console Port

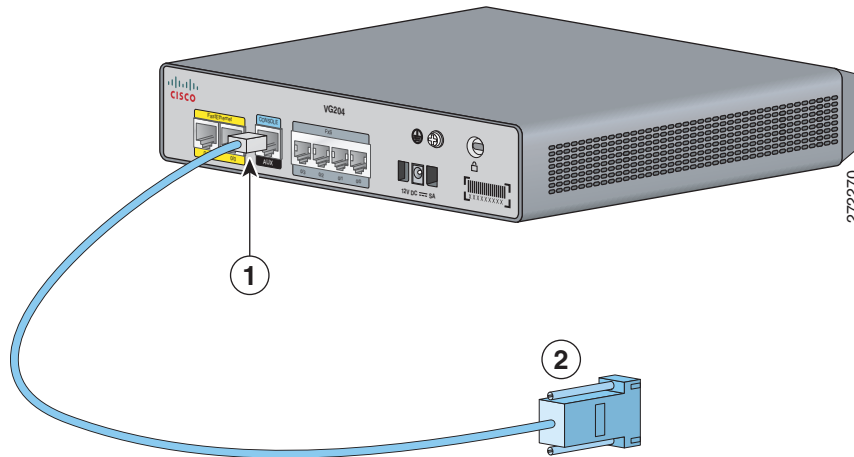

<b>1</b>	RJ-45 connector to the Console Aux port on the chassis	<b>2</b>	DB-9 connector
----------	--	----------	----------------

- Step 2** Connect the DB-9 end of the RJ-45-to-DB-9 serial cable to the to the COM port on your laptop or PC.



**Note** Some laptops and personal computers do not have DB-9 serial port connectors and may require a USB to serial port adapter.

- Step 3** To communicate with the voice gateway, begin a terminal emulator application.

## Connecting an FXS Line

Use a standard straight-through RJ-11 modular telephone cable to connect a Foreign Exchange Service (FXS) port to a telephone or fax machine.



**This equipment contains a ring signal generator (ringer), which is a source of hazardous voltage. Do not touch the RJ-11 (phone) port wires (conductors), the conductors of a cable connected to the RJ-11 port, or the associated circuit-board when the ringer is active. The ringer is activated by an incoming call.**



**For connections outside the building where the equipment is installed, the following ports must be connected through an approved network termination unit with integral circuit protection: FXS.**

**Procedure**

- Step 1** Connect one end of the straight-through RJ-11 cable to the FXS port. [Figure 3-8](#) shows an FXS line connection.

**Figure 3-8** Connecting an FXS Line

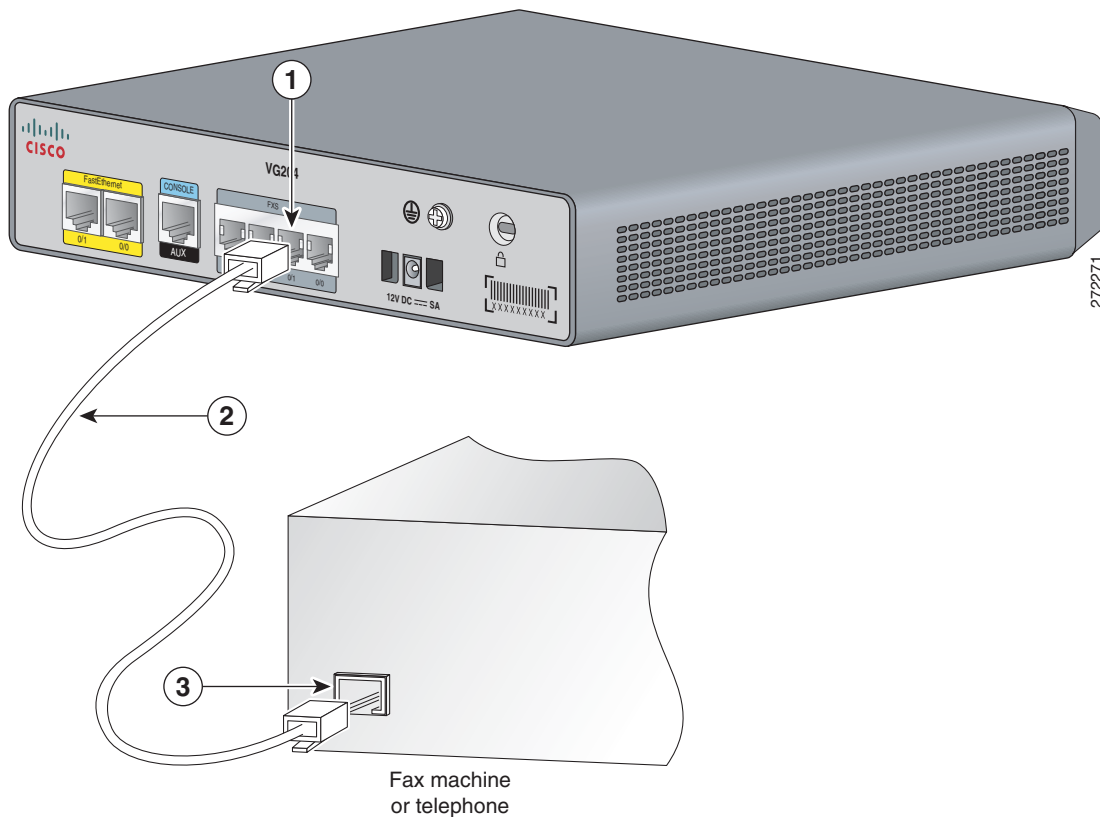

<b>1</b>	FXS port	<b>2</b>	RJ-11 cable
<b>3</b>	RJ-11 port		

- Step 2** Connect the other end of the cable to the RJ-11 port on the telephone or fax machine.





# Powering On the Voice Gateway and Performing the Initial Configuration

---

- [Powering On the Voice Gateway, page 4-1](#)
- [Performing the Initial Configuration, page 4-2](#)
- [Troubleshooting, page 4-6](#)

## Powering On the Voice Gateway

Perform this procedure to power on your Cisco VG202, Cisco VG202XM, Cisco VG204, or Cisco VG204XM voice gateway and to verify that the device completes its initialization and self-test.

### Before You Begin

Before you power on the voice gateway, ensure that it meets the following requirements:

- The chassis is securely mounted. See [Mounting the Chassis onto a Wall, page 3-5](#) and [Setting the Chassis on a Desktop, page 3-7](#).
- The power cable is connected. See [Connecting Input Power to the Chassis, page 3-10](#).
- The interface cables are connected. See [Connecting a Terminal or PC to the Console Port, page 3-10](#) and [Connecting an FXS Line, page 3-11](#).

### Procedure

---

- Step 1** Plug in the external power supply.
- The green OK LED lights up. If this does not happen, see the [“Troubleshooting” section on page 4-6](#).
- The system displays the following message at the end of the bootup messages:
- ```
--- System Configuration Dialog ---  
Continue with configuration dialog? [yes/no]:
```
- Step 2** Enter **no** to proceed with manual configuration using the command-line interface (CLI):
- ```
Would you like to enter the initial configuration dialog? [yes/no]: no  
Would you like to terminate autoinstall? [yes]
```
- Step 3** Press **Return** to terminate autoinstall and to continue with manual configuration.
- The system displays several messages, ending with lines similar to the following:

```
...
Copyright (c) 2013 by Cisco Systems, Inc.
Compiled <date> <time> by <person>
```

**Step 4** Press **Return** to bring up the voice gateway prompt:

```
...
flashfs[4]: Initialization complete.
VG>
```

**Step 5** Enter privileged EXEC mode:

```
VG> enable
VG#
```



---

**Note** If the `rommon 1>` prompt appears, your system has booted in ROM monitor mode. For information on the ROM monitor, see the voice gateway rebooting and ROM monitor information in the *Cisco IOS Configuration Fundamentals Configuration Guide* for your Cisco IOS software release.

---

## Performing the Initial Configuration

You initially configure your voice gateway by using the Cisco IOS CLI. Then you use the `setup` command which guides you through the configuration process by prompting you for the specific information that is needed to configure your system. After creating the initial configuration file, you can use the Cisco IOS CLI to perform further configuration.

- [Using the Cisco IOS CLI to Configure the Voice Gateway, page 4-2](#)
- [Using the setup Command to Configure the Voice Gateway, page 4-3](#)
- [Verifying and Saving Your Configuration, page 4-5](#)

## Using the Cisco IOS CLI to Configure the Voice Gateway

### Procedure

---

**Step 1** Set up a console connection to your voice gateway.

The system displays the following message:

```
...
voice gateway con0 is now available
```

**Step 2** Press **Return** or **Enter**.

The system displays the following message:

```
Cisco Configuration Professional Express (Cisco CP Express) is installed on this device.
This feature requires the one-time use of the username "cisco"
with the password "cisco." The default username and password have a privilege level of 15.

Please change these publicly known initial credentials using Cisco CP Express or the Cisco
IOS CLI.
```

Here are the Cisco IOS commands.

```
username <myuser> privilege 15 secret 0 <mypassword>
no username cisco
```

Replace <myuser> and <mypassword> with the username and password you want to use.

For more information about Cisco CP please follow the instructions in the QUICK START GUIDE for your voice gateway...

...

User Access Verification

Username:

**Step 3** Enter the username *cisco*, and press **Return** or **Enter**.

The system displays the following prompt:

Password:

**Step 4** Enter the password *cisco*, and press **Return** or **Enter**.

The system displays the following prompt:

VG#

The system displays a message that is similar to the first warning message. The message directs you to change the username and password.

You are now in privileged EXEC mode.



---

**Note** You must change the username and password before you log off the voice gateway. You cannot use the username *cisco* or password *cisco* after you log off from this session.

---

**Step 5** To change the username and password, enter the following at the prompt:

```
username username privilege 15 secret 0 password
```

Where *username* and *password* are the username and password that you wish to use.

**Step 6** Use the **copy running-config startup-config** command at the privileged EXEC mode prompt (VG#) to save the configuration to NVRAM.

---

## Using the setup Command to Configure the Voice Gateway

### Before You Begin

Perform the procedure in the [“Using the Cisco IOS CLI to Configure the Voice Gateway”](#) section on page 4-2.

### Procedure

**Step 1** In privileged EXEC mode, at the prompt, enter **setup**.

```
yourname# setup
```

The system displays the following message:

```
--- System Configuration Dialog ---
```

Continue with configuration dialog? [yes/no]:

You are now in the setup command facility.

The prompts in the setup command vary, depending on your voice gateway model, on the installed interface modules, and on the software image. The following steps and the user entries (in bold) are shown as examples only.



---

**Note** If you make a mistake while using the setup command facility, you can exit and run the setup command facility again. Press **Ctrl-C**, and enter the **setup** command at the privileged EXEC mode prompt (VG#).

---

**Step 2** To proceed using the setup command, enter **yes**:

Continue with configuration dialog? [yes/no]: **yes**

**Step 3** When the following messages appear, enter **yes** to enter basic management setup:

At any point you may enter a question mark '?' for help.  
Use ctrl-c to abort configuration dialog at any prompt.

Default settings are in square brackets '[]'.

Basic management setup configures only enough connectivity  
for management of the system, extended setup will ask you  
to configure each interface on the system

Would you like to enter basic management setup? [yes/no]: **yes**

**Step 4** Enter a hostname for the voice gateway.

Configuring global parameters:  
Enter host name [VG]: **VG**

**Step 5** Enter an enable secret password. This password is encrypted (more secure) and cannot be seen when viewing the configuration.

The enable secret is a password used to protect access to  
privileged EXEC and configuration modes. This password, after  
entered, becomes encrypted in the configuration.  
Enter enable secret: **xxxxxxxx**

**Step 6** Enter an enable password that is different from the enable secret password. This password is not encrypted (less secure) and can be seen when viewing the configuration.

The enable password is used when you do not specify an  
enable secret password, with some older software versions, and  
some boot images.  
Enter enable password: **xxxxxxxx**

**Step 7** Enter the virtual terminal password, which prevents unauthenticated access to the voice gateway through ports other than the console port:

The virtual terminal password is used to protect  
access to the voice gateway over a network interface.  
Enter virtual terminal password: **xxxxxxx**

**Step 8** Respond to the following prompt as appropriate for your network:

Configure SNMP Network Management? [yes]:  
Community string [public]:

The system displays a summary of the available interfaces.

- Step 9** Choose one of the available interfaces for connecting the voice gateway to the management network:

```
Enter interface name used to connect to the
management network from the above interface summary: fastethernet4
```

- Step 10** Respond to the following prompts as appropriate for your network:

```
Configuring interface FastEthernet0/0:
Use the 100 Base-TX (RJ-45) connector? [yes]: yes
Operate in full-duplex mode? [no]: yes
Configure IP on this interface? [yes]: yes
  IP address for this interface: 172.1.2.3
  Subnet mask for this interface [255.255.0.0] : 255.255.0.0
  Class B network is 172.1.0.0, 26 subnet bits; mask is /16
```

The system displays the configuration:

The following configuration command script was created:

```
hostname VG
enable secret 5 $1$D5P6$PYx41/lQIASK.HcSbf05q1
enable password xxxxxx
line vty 0 4
password xxxxxx
snmp-server community public
!
no ip routing
!
interface FastEthernet0/0
no shutdown
speed 100
duplex auto
ip address 172.1.2.3 255.255.0.0
!
```

- Step 11** Respond to the following prompts. Enter **2** to save the initial configuration.

```
[0] Go to the IOS command prompt without saving this config.
[1] Return back to the setup without saving this config.
[2] Save this configuration to nvram and exit.
```

```
Enter your selection [2]: 2
Building configuration...
Use the enabled mode 'configure' command to modify this configuration.
```

```
Press RETURN to get started! RETURN
```

```
The user prompt is displayed.
VG>
```

## Verifying and Saving Your Configuration

To verify the configuration and save it in NVRAM so that the configuration remains in effect after you restart the voice gateway, enter the following commands:

	Command	Purpose
Step 1	VG# <code>show running-config</code>	Displays the current operating configuration, including any changes you have just made.
Step 2	VG# <code>show startup-config</code>	Displays the configuration currently stored in NVRAM.
Step 3	VG# <code>copy running-config startup-config</code>	Writes the current running configuration to NVRAM, where it overwrites the startup configuration and becomes the new startup configuration.  <b>Note</b> If you reboot the Cisco VG202, Cisco VG202XM, Cisco VG204, or Cisco VG204XM voice gateway or turn off the power before you complete this step, you lose the configuration.

## Troubleshooting

This section describes possible mechanical problems and corrective actions.

### Before You Begin

If there appears to be a malfunction, first check all cables and connections.

**Table 4-1** Troubleshooting the Cisco VG202, Cisco VG202XM, Cisco VG204, or Cisco VG204XM Voice Gateway

Symptom	Possible Cause	Corrective Action
OK LED is off	Faulty DC cable	Check or replace the cable.
	Faulty DC power supply	Check or replace the DC power supply. Check that the DC is plugged in. Check that the AC cable is plugged in.
	Faulty power source	Check or correct the input power.
	Faulty internal power supply	Contact Cisco <sup>1</sup> or your Cisco reseller.
Unit shuts off after operating for some time	Overheating	Check ventilation.
	Faulty voice gateway	Contact Cisco <sup>1</sup> or your Cisco reseller.
Console screen display freezes	Console fault	Reset or replace the console.
	Software error	Repeat the power-on procedure.
	Faulty voice gateway	Contact Cisco <sup>1</sup> or your Cisco reseller.

1. See the “Obtaining Documentation and Submitting a Service Request” section on page vii.



---

## B

brackets [3-5](#)

---

## C

cable distance limitations [2-2](#)

caution messages [3-7](#)

chassis [1-3, 1-4, 1-5](#)

chassis types (illustrated) [1-2](#)

checklist, installation [3-3](#)

Cisco IOS software [1-7](#)

computer, for configuration [3-4](#)

configuration methods

[1-7, 1-8](#)

connecting

PC to the console port [3-10](#)

console port

connecting

to a PC [3-10](#)

console terminal [3-4](#)

controls, descriptions of [1-3](#)

crimping the ground lug onto the Ground wire [3-8](#)

---

## D

documentation [3-vi](#)

---

## E

electrical safety guidelines [3-1, 3-2](#)

electromagnetic interference

See EMI

electrostatic discharge

See ESD

EMI [2-2, 2-3](#)

ESD [3-2](#)

---

## F

fan, cooling [1-8](#)

Fast Ethernet cables, distance limitations [2-3](#)

figures

chassis [1-3, 1-4, 1-5](#)

Crimping the Ground Lug onto the Ground Wire [3-8](#)

Installation Checklist [3-3](#)

---

## G

ground loops, EMI effects of [2-3](#)

---

## H

humidity specification [1-8](#)

---

## I

indicators

See LEDs

installation [3-3, 3-4](#)

installation checklist [3-3](#)

interface options [1-1](#)

IOS

See Cisco IOS software

---

## L

lightning, EMI effects [2-3](#)  
log, record keeping [3-3](#)

---

## M

malfunctions, how to diagnose [4-6](#)  
mounting methods [2-1](#)

---

## N

noise level, fan [1-8](#)

---

## O

operating system [1-7](#)

---

## P

packing list [3-4](#)  
problems, diagnosing and correcting [4-6](#)

---

## R

radio-frequency interference  
    See EMI  
record keeping [3-3](#)  
related documentation [3-vi](#)

---

## S

safety [3-1, 3-2, 3-3](#)  
software. Cisco IOS [1-7](#)  
specifications, technical [1-8](#)  
static electricity prevention [3-2](#)

---

## T

Telnet [1-8](#)  
tools required for installation [3-4](#)

---

## W

wall-mounting the chassis [3-5](#)  
warnings [2-2](#)  
warnings, safety [3-vii, 1-9, 3-9](#)  
weight, chassis [1-8](#)