

# *Pioneer*

---

CD PLAYER

# DEX-P99RS

 **Radio**  
READY

**SUPER TUNER III D**

Operation Manual

*English*

## Thank you for purchasing this PIONEER product.

Please read through this manual before using the product for the first time, to ensure proper use. *After reading, please keep the manual in a safe and accessible place for future reference.*

### 01 Before You Start

- Information to User **5**
- For Canadian model **5**
- About this unit **5**
- About this manual **5**
- After-sales service for Pioneer products **6**
- Visit our website **6**
- Features **6**
- Protecting your unit from theft **7**
  - Removing the front panel **7**
  - Attaching the front panel **7**
- Resetting the microprocessor **7**
- Reverse mode **8**
- Use and care of the remote control **8**
  - Installing and removing the battery **8**
  - Using the remote control **8**

### 02 Operating this unit

- What's what **10**
  - Head unit **10**
  - Steering remote control **10**
- Basic Operations **11**
  - Power ON/OFF **11**
  - Selecting a source **11**
  - Loading a disc **12**
  - Adjusting the volume **12**
- Tuner **13**
  - Basic Operations **13**
  - Storing and recalling broadcast frequencies **13**
  - Introduction to advanced operations **13**
  - Storing the strongest broadcast frequencies **14**
  - Tuning in strong signals **14**
- Built-in CD Player **14**
  - Basic Operations **14**
  - Displaying text information on disc **15**
  - Selecting tracks from the track title list **15**
  - Selecting files from the file name list **16**

- Introduction to advanced operations **16**
- Selecting a repeat play range **16**
- Playing tracks in random order **16**
- Scanning folders and tracks **17**
- Pausing playback **17**
- Using disc title functions **17**
- Playing songs in a USB storage device **18**
  - Basic Operations **18**
  - Displaying text information of an audio file **18**
  - Selecting files from the file name list **18**
  - Introduction to advanced operations **19**
- Playing songs on iPod **20**
  - Basic Operations **20**
  - Browsing for a song **20**
  - Displaying text information on iPod **21**
  - Introduction to advanced operations **21**
  - Playing songs in a random order (shuffle) **22**
  - Playing all songs in a random order (shuffle all) **22**
  - Playing songs related to the currently playing song **22**
  - Operating this unit's iPod function from your iPod **22**
  - Changing audiobook speed **23**

### 03 Audio Adjustments

- Operation modes **24**
  - Adjusting the audio easily **24**
  - Adjusting the audio finely **24**
  - Extra functions **24**
- Introduction of audio adjustments **24**
- Switching left and right channel **25**
- Using balance adjustment **25**
- Using the position selector **25**
- About the network function **25**
  - Adjustable parameters **26**

- Points concerning network adjustments **26**
  - Muting the speaker unit (filter) **27**
  - Adjusting network **27**
  - Using the time alignment **28**
    - Adjusting the time alignment **29**
  - Recalling or copying equalizer curves **29**
    - Recalling the equalizer curve **29**
    - Copying the equalizer curve **30**
  - Fine-adjusting equalizer curve **30**
  - Using the auto-equalizer **30**
  - Using the sound retriever **31**
  - Adjusting loudness **31**
  - Adjusting source levels **31**
  - Auto TA and EQ (auto-time alignment and auto-equalizing) **31**
    - Before operating the auto TA and EQ function **32**
    - Carrying out auto TA and EQ **33**
- 04 Initial Settings**
- Adjusting initial settings **35**
  - Selecting the display language **35**
  - Setting the speakers **35**
  - Setting the clock **36**
  - Switching the warning tone **36**
  - Switching the face auto open **36**
  - Switching the auxiliary setting **36**
  - Switching the dimmer setting **36**
  - Adjusting the brightness **37**
  - Selecting the illumination color **37**
  - Adjusting the illumination color **37**
  - Setting the illumination interlock **37**
  - Correcting distorted sound **38**
  - Resetting the audio functions **38**
  - Switching the sound muting/attenuation **38**
  - Setting the polarity of the door operation **38**
  - Setting the door mute setting **38**
  - Switching the reverse mode **39**
  - Switching the ever scroll **39**
  - Activating the BT Audio source **39**
  - Entering PIN code for Bluetooth wireless connection **39**
  - Displaying system version for repair **40**

## **05 Other Functions**

- Using the AUX source **41**
  - About AUX1 and AUX2 **41**
  - AUX1 source: **41**
  - AUX2 source: **41**
  - Selecting AUX as the source **41**
  - Setting the AUX title **41**
- Turning the clock display on or off **41**
- Using the external unit **42**
  - Selecting the external unit as the source **42**
  - Basic operation **42**
  - Advanced operations **42**
- Using different entertainment displays **42**
- Using the DF (direct function) button **42**

## **06 Available accessories**

- XM tuner **44**
  - Listening to XM Satellite Radio **44**
  - Switching the XM display **44**
  - Storing and recalling broadcast stations **44**
  - Selecting the XM channel select mode **44**
  - Displaying the Radio ID **45**
- SIRIUS Satellite Radio tuner **45**
  - Listening to SIRIUS Satellite Radio **45**
  - Switching the SIRIUS display **46**
  - Storing and recalling broadcast stations **46**
  - Introduction of advanced operations **46**
  - Selecting the SIRIUS channel select mode **47**
  - Using the Game Alert function **47**
  - Displaying the Radio ID **48**
  - Using Instant Replay function **48**
- HD Radio™ tuner **49**
  - Basic Operations **49**
  - Storing and recalling broadcast frequencies **49**
  - Switching the display **49**
  - Introduction to advanced operations **49**

- Switching the seek mode **50**
- Switching the reception mode **50**
- Playing songs on iPod **50**
  - Basic operation **50**
  - Displaying text information on iPod **51**
  - Browsing for a song **51**
  - Introduction to advanced operations **51**
- Bluetooth Audio **51**
  - Basic Operations **52**
  - Function and operation **52**
  - Connecting a Bluetooth audio player **53**
  - Playing songs on a Bluetooth audio player **53**
  - Stopping playback **53**
  - Disconnecting a Bluetooth audio player **53**
  - Displaying BD (Bluetooth Device) address **53**
- Bluetooth Telephone **54**
  - Basic Operations **54**
  - Setting up for hands-free phoning **54**
  - Making a phone call **55**
  - Taking a phone call **55**
  - Function and operation **56**
  - Connecting a cellular phone **56**
  - Disconnecting a cellular phone **57**
  - Registering a connected cellular phone **57**
  - Deleting a registered phone **57**
  - Connecting to a registered cellular phone **58**
  - Using the phone book **58**
  - Using the call history **60**
  - Making a call by entering phone number **61**
  - Clearing memory **61**
  - Setting automatic rejecting **62**
  - Setting automatic answering **62**
  - Switching the ring tone **62**

- Echo canceling and noise reduction **62**
- Multi-CD Player **62**
  - Basic Operations **62**
  - Using CD TEXT functions **63**
  - Introduction to advanced operations **63**
  - Using compression and bass emphasis **64**
  - Using ITS playlists **64**
  - Using disc title functions **65**
- DVD Player **66**
  - Basic Operations **66**
  - Introduction to advanced operations **66**

## ● Additional Information

- Error messages **68**
- Understanding auto TA and EQ error messages **69**
- Handling guideline of discs and player **70**
- DualDiscs **70**
- Handling guideline of USB storage device and this unit **70**
- Compressed audio compatibility (disc, USB) **71**
  - Supplemental information of compressed audio (disc, USB) **71**
- Compressed audio files on the disc **71**
- Compressed audio files in the USB storage device **72**
- Example of a hierarchy and playback sequences **72**
  - The sequence of audio files on the disc **72**
  - The sequence of audio files on the USB storage device **72**
- iPod **72**
  - iPod compatibility **72**
  - About handling the iPod **73**
  - About iPod settings **73**
- Copyright and trademark notice **73**
- Specifications **75**

## Before You Start

This device complies with part 15 of the FCC Rules. Operation is subject to the following two conditions:

(1) This device may not cause harmful interference, and (2) this device must accept any interference received, including interference that may cause undesired operation.

## Information to User

Alteration or modifications carried out without appropriate authorization may invalidate the user's right to operate the equipment.



## For Canadian model

This Class B digital apparatus complies with Canadian ICES-003.



## About this unit

The tuner frequencies on this unit are allocated for use in North America. Use in other areas may result in poor reception.

### WARNING

Handling the cord on this product or cords associated with accessories sold with the product will expose you to chemicals listed on proposition 65 known to the State of California and other governmental entities to cause cancer and birth defect or other reproductive harm. **Wash hands after handling.**

**CAUTION:**  
**USE OF CONTROL OR ADJUSTMENT OR PERFORMANCE OF PROCEDURES OTHER THAN THOSE SPECIFIED HEREIN MAY RESULT IN HAZARDOUS RADIATION EXPOSURE.**

**CAUTION:**  
**THE USE OF OPTICAL INSTRUMENTS WITH THIS PRODUCT WILL INCREASE EYE HAZARD.**

### CAUTION

- Do not allow this unit to come into contact with liquids. Electrical shock could result. Also, damage to this unit, smoke, and overheating could result from contact with liquids.
- Keep this manual handy as a reference for operating procedures and precautions.
- Always keep the volume low enough so that you can hear sounds from outside the vehicle.
- Protect this unit from moisture.
- If the battery is disconnected or discharged, the preset memory will be erased and must be reprogrammed.

### Important (Serial number)

The serial number is located on the bottom of this unit. For your own security and convenience, be sure to record this number on the enclosed warranty card. 

## About this manual

This unit features a number of sophisticated functions ensuring superior reception and operation. All the functions have been designed for the easiest possible use, but many are not self-explanatory. This operation manual will help you benefit fully from this unit's potential and to maximize your listening enjoyment.

## Before You Start

We recommend that you familiarize yourself with the functions and their operation by reading through the manual before you begin using this unit. It is especially important that you read and observe **WARNINGS** and **CAUTIONS** in this manual. 

### After-sales service for Pioneer products

Please contact the dealer or distributor from where you purchased this unit for after-sales service (including warranty conditions) or any other information. In case the necessary information is not available, please contact the companies listed below:

Please do not ship your unit to the companies at the addresses listed below for repair without advance contact.

#### U.S.A.

Pioneer Electronics (USA) Inc.  
CUSTOMER SUPPORT DIVISION  
P.O. Box 1760  
Long Beach, CA 90801-1760  
800-421-1404

#### CANADA

Pioneer Electronics of Canada, Inc.  
CUSTOMER SATISFACTION DEPARTMENT  
300 Allstate Parkway  
Markham, Ontario L3R 0P2  
1-877-283-5901  
905-479-4411

For warranty information please see the Limited Warranty sheet included with this unit. 

### Visit our website

Visit us at the following site:

**<http://www.pioneerelectronics.com>**

- 1 Register your product. We will keep the details of your purchase on file to help you refer to

this information in the event of an insurance claim such as loss or theft.

- 2 Receive updates on the latest products and technologies.
- 3 Download owner's manuals, order product catalogues, research new products, and much more. 

### Features

This unit is compatible with a wide variety of file formats and media/storage devices.

#### File format compatibility

- WMA
- MP3
- AAC
- WAV

For details about compatibility, refer to *Additional Information* on page 68.

#### Media/storage device compatibility

- CD/CD-R/CD-RW
  - USB portable audio player/USB memory
- Make inquiries to the manufacturer about your USB portable audio player/USB memory. For details about compatibility, refer to *Additional Information* on page 68.

#### iPod compatibility

This unit can control and listen to songs on an iPod.

In this manual, iPod and iPhone will be referred to as iPod.

For details about the supported iPod, refer to *iPod compatibility* on page 72.



#### CAUTION

- Pioneer accepts no responsibility for data lost on the USB memory/USB portable audio player even if that data is lost while using this unit.
- Pioneer accepts no responsibility for data lost on the iPod even if that data is lost while using this unit. 

## Before You Start

### Protecting your unit from theft

The front panel can be detached to deter theft.

- If the front panel is not detached from the head unit within five seconds of turning off the ignition, a warning tone sounds.
- You can turn off the warning tone. Refer to *Switching the warning tone* on page 36.

#### Important

- Handle gently when removing or attaching the front panel.
- Avoid subjecting the front panel to excessive shock.
- Keep the front panel out of direct sunlight and high temperatures.

### Removing the front panel

#### 1 Press **▲/Open** to open the front panel.

If a disc has been inserted to this unit, pressing and holding **▲/Open** enable to open the front panel without ejecting a disc.

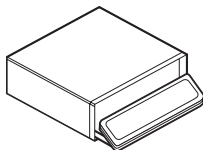

#### 2 Press the release button, slide and remove the front panel toward you.

Take care not to grip it too tightly or to drop the front panel and protect it from contact with water or other fluids to prevent permanent damage.

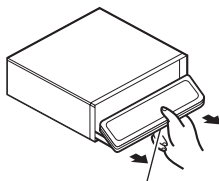

Release button

- 3 Put the front panel into the provided protective case for safe keeping.

### Attaching the front panel

- 1 Make sure the inner cover is closed.
- 2 Replace the front panel by clipping it into place.

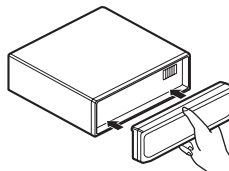

### Resetting the microprocessor

The microprocessor must be reset under the following conditions:

- Prior to using this unit for the first time after installation
  - If the unit fails to operate properly
  - When strange or incorrect messages appear on the display
- Press **RESET** with a pen tip or other pointed instrument.

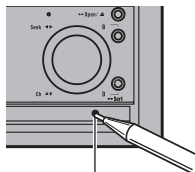

RESET button



## Reverse mode

If you do not perform an operation within about 30 seconds, screen indications start to reverse, and then continue reversing every 10 seconds. Pressing button **B** when power to this unit is turned off while the ignition switch is set to ACC or ON cancels the reverse mode. Press button **B** again to start the reverse mode. 

## Use and care of the remote control

### Installing and removing the battery

Slide the tray on the back of the remote control out and insert the battery with the plus (+) and minus (-) poles aligned properly.

- When using for the first time, pull out the film protruding from the tray.

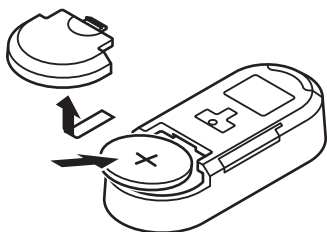

### WARNING

- Keep the battery out of the reach of children. Should the battery be swallowed, consult a doctor immediately.
- Batteries (battery pack or batteries installed) shall not be exposed to excessive heat such as sunshine, fire or the like.

### CAUTION

- Use one **CR2032 (3 V)** lithium battery.
- Remove the battery if the remote control is not used for a month or longer.

- There is a danger of explosion if the battery is incorrectly replaced. Replace only with the same or equivalent type.
- Do not handle the battery with metallic tools.
- Do not store the battery with metallic objects.
- If the battery leaks, wipe the remote control completely clean and install a new battery.
- When disposing of used batteries, comply with governmental regulations or environmental public institutions' rules that apply in your country/area.
- "Perchlorate Material – special handling may apply.  
See [www.dtsc.ca.gov/hazardouswaste/perchlorate](http://www.dtsc.ca.gov/hazardouswaste/perchlorate). (Applicable to California, U.S.A.)"

## Using the remote control

The remote control may not function properly in direct sunlight.

### Important

- Do not store the remote control in high temperatures or direct sunlight.
- Do not let the remote control fall onto the floor, where it may become jammed under the brake or accelerator pedal.
- If any of the following problems occur, immediately stop using the unit and consult the dealer from whom you purchased it.
  - Smoke is coming from the unit.
  - Abnormal odor is coming from the unit.
  - A foreign object has entered the unit.
  - Liquid has been spilled on or into the unit.
 If you continue to use this unit without finding a remedy, the unit may be damaged badly, resulting in a serious accident or fire.
- Do not disassemble or modify this unit. To do so may cause a malfunction.
- Do not operate this unit while manipulating the steering wheel as it might result in a traffic accident.
- If you need to operate this unit while driving, look ahead carefully to avoid being involved in a traffic accident.



## Before You Start

- Do not leave this steering remote control free (unattached). When stopping the car or turning, the unit might drop on the floor. If the unit rolls under the brake pedal, it might prevent the driver from braking properly, causing serious problems. Be sure to fix the steering remote control to the steering wheel. 

## What's what

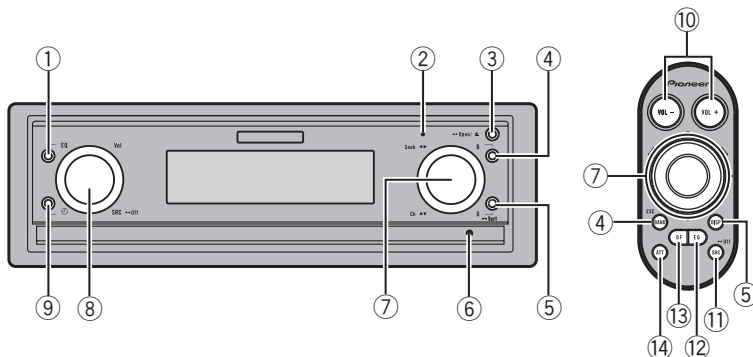

### Head unit

#### ① EQ button

Press to select various equalizer curves.  
Press and hold to turn the display indication and button illumination off or on.

#### ② Display off indicator

Lights up when the display is turned off.

#### ③ ▲/Open button

Press to eject a disc from this unit.  
Press and hold to open or close the front panel.

#### ④ B button

Press to select among three FM bands and one AM band.  
Press to return to the ordinary display when operating the menu.

- When SIRIUS tuner is selected as the source, press and hold to perform the Instant Replay mode.

#### ⑤ D/Scrl button

Press to select different displays.  
Press and hold to scroll through the text information.

#### ⑥ RESET button

Press to reset the microprocessor.

#### ⑦ MULTI-CONTROL

Move to perform manual seek tuning, fast forward, reverse and track search controls. Also used for controlling functions. Turn to display the disc title list, track title list, folder list, file list or preset channel list depending on the source.

#### ⑧ SRC/Off button, Vol

This unit is turned on by selecting a source. Press to cycle through all the available sources. Rotate it to increase or decrease the volume.

#### ⑨ ⏸ button

Press to change to the clock display.

- When XM tuner or SIRIUS tuner is selected as the source, press to change the channel select mode.

### Steering remote control

Operation is the same as when using the buttons on the head unit.

#### ⑩ VOL -/VOL + buttons

Press to increase or decrease the volume.

## Operating this unit

### ⑪ SRC/Off button

This unit is turned on by selecting a source. Press to cycle through all the available sources.

### ⑫ EQ button

Press to select various equalizer curves.

### ⑬ DF button

Press to operate the preprogrammed functions for each source. (Refer to *Using the DF (direct function) button* on page 42.)

### ⑭ ATT button

Press to quickly lower the volume level by about 90%. Press once more to return to the original volume level. 

## Basic Operations

### Power ON/OFF

#### Turning the unit on

- Press **SRC/Off** to turn the unit on.

#### Turning the unit off

- Press **SRC/Off** and hold until the unit turns off.

### Selecting a source

You can select a source you want to listen to.

- Press **SRC/Off** repeatedly to switch between the following sources.

**XM** (XM tuner)—**SIRIUS** (SIRIUS tuner)—**HD Radio** (HD Radio tuner)—**Tuner** (tuner)—**DVD** (DVD player/multi-DVD player)—**CD** (built-in CD player)—**Multi CD** (multi-CD player)—**iPod** (iPod connected with the interface adapter)—**USB** (USB storage device)/**iPod** (iPod connected using USB input)—**EXT** (external unit 1)—**EXT** (external unit 2)—**AUX1** (AUX1)—**AUX2** (AUX2)—**BT Audio** (BT audio)—**TEL** (BT telephone)



#### Notes

- In the following cases, the sound source will not change.
  - When no unit corresponding to the selected source is connected.
  - When there is no disc or magazine in the player.
  - When the iPod is not connected to this unit with the interface adapter.
  - When AUX (auxiliary input) is set to off (refer to page 36).
  - When the **BT Audio** source is set to off (refer to *Activating the BT Audio source* on page 39).
- When an USB storage device or iPod is not connected to the USB port of this unit, **NO DEVICE** is displayed.

## Operating this unit

- If the HD Radio tuner is connected to this unit, tuner source is skipped.
- AUX1 is set to on by default. Turn off the AUX1 when not in use (refer to *Switching the auxiliary setting* on page 36).
- Charging the portable audio player using car's DC power source while connecting it to AUX input may generate noise. In this case, stop charging.
- External unit refers to a Pioneer product (such as ones available in the future) that, although incompatible as a source, enables control of basic functions with this unit. Two external units can be controlled with this unit. When two external units are connected, the external unit is automatically allocated to external unit 1 or external unit 2 by this unit.
- When this unit's blue/white lead is connected to the vehicle's auto-antenna relay control terminal, the vehicle's antenna extends when this unit's source is turned on. To retract the antenna, turn the source off.
- Certain devices may need to be switched on before being connected to this unit.

### Loading a disc

**1 Press ▲/Open to open the front panel.**  
CD loading slot appears.

**2 Insert a CD into the CD loading slot.**  
Front panel is closed automatically, and playback will start.

- **When loading a CD/CD-R/CD-RW, face the label side of a disc up.**

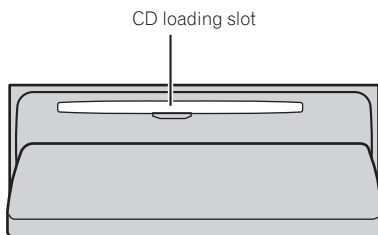

- You can eject a disc by pressing ▲/Open.

- After a CD has been inserted, press **SRC/Off** to select the built-in CD player.



### Notes

- The built-in CD player plays one, standard, 12-cm CD (-R/-RW) at a time. Playing back an 8-cm disc is not possible with this unit.
- The built-in CD player can play back audio CD and compressed audio recorded on a CD-ROM. (Please see the following section for files that can be played back. Refer to page 71.)
- Read the precautions for the player and discs in the following section. Refer to page 70.
- Do not insert anything other than a CD into the CD loading slot.
- There is sometimes a delay between starting up disc playback and the sound being issued. When being read, **FORMAT READ** is displayed.
- If you cannot insert a disc completely or if after you insert a disc the disc does not play, check that the label side of the disc is up. Press ▲/Open to eject the disc, and check the disc for damage before inserting it again.
- When the disc loading or ejecting function does not operate properly, you can eject the disc by pressing and holding ▲/Open while opening the front panel.
- If an error message is displayed, refer to *Error messages* on page 68.

### Adjusting the volume

- **Use Vol to adjust the sound level.**
  - With the remote control, press **VOL +/VOL -** to adjust the volume. 

## Operating this unit

### Tuner

#### Basic Operations

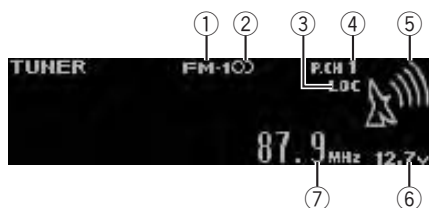

- ① Band indicator
- ②  (stereo) indicator  
Appears when the selected frequency is being broadcast in stereo.
- ③ **LOC** indicator  
Appears when local seek tuning is on.
- ④ Preset number indicator
- ⑤ Signal level indicator  
Shows the radio wave strength.
- ⑥ Voltage indicator  
Shows the battery voltage.
  - The level displayed on the voltage indicator may differ from the actual voltage level.
- ⑦ Frequency indicator

#### ● Select a band

Press **B**.

- Band can be selected from among **FM1**, **FM2**, **FM3** or **AM**.

#### ● Manual tuning (step by step)

Push **MULTI-CONTROL** left or right.

#### ● Seek tuning

Push and hold **MULTI-CONTROL** left or right, and then release.

- You can cancel seek tuning by pushing **MULTI-CONTROL** left or right.
- While pushing and holding **MULTI-CONTROL** left or right, you can skip stations. Seek tuning starts as soon as you release **MULTI-CONTROL**.

### Storing and recalling broadcast frequencies

You can easily store up to six broadcast frequencies for later recall.

- Six stations for each band can be stored in memory.

#### 1 Use **MULTI-CONTROL** to store the selected frequency in memory.

Turn to change the preset number. Press and hold to store.

#### 2 Use **MULTI-CONTROL** to select the desired station.

Turn to change the station. Press to select.

- All stations stored for FM bands can be recalled from each independent FM band.
- You can also change the station by pushing **MULTI-CONTROL** up or down.
- To return to the ordinary display, press **B**.
- If you do not operate the list within about 30 seconds, the display automatically returns to the ordinary display.
- You can also recall radio station frequencies assigned to preset tuning numbers by pushing **MULTI-CONTROL** up or down during the frequency display.

### Introduction to advanced operations

#### 1 Press **MULTI-CONTROL** to display the main menu.

#### 2 Use **MULTI-CONTROL** to select **FUNCTION**.

Turn to change the menu option. Press to select.

#### 3 Turn **MULTI-CONTROL** to select the function.

**BSM** (best stations memory)—**Local** (local seek tuning)



#### Notes

- To return to the ordinary display, press **B**.

## Operating this unit

- If you do not operate functions within about 30 seconds, the display automatically returns to the ordinary display.

### Storing the strongest broadcast frequencies

BSM (best stations memory) lets you automatically store the six strongest broadcast frequencies.

#### 1 Use MULTI-CONTROL to select BSM in the function menu.

Refer to *Introduction to advanced operations* on the previous page.

#### 2 Press MULTI-CONTROL to turn BSM on.

The six strongest broadcast frequencies are stored in the order of their signal strength.

- To cancel, press **MULTI-CONTROL** again.

### Tuning in strong signals

Local seek tuning lets you tune in only those radio stations with sufficiently strong signals for good reception.

#### 1 Use MULTI-CONTROL to select Local in the function menu.

**Local** appears in the display.

#### 2 Press MULTI-CONTROL to turn local seek tuning on.

- To turn local seek tuning off, press **MULTI-CONTROL** again.

#### 3 Push MULTI-CONTROL left or right to select the desired setting.

FM: **Level 1—Level 2—Level 3—Level 4**

AM: **Level 1—Level 2**

Larger setting number is higher level. The highest level setting allows reception of only the strongest stations, while lower settings let you receive progressively weaker stations.

## Built-in CD Player

### Basic Operations



- ① **WMA/MP3/AAC/WAV** indicator  
Shows the type of audio file currently playing when the compressed audio is playing.
  - ② Folder number indicator  
Shows the folder number currently playing when the compressed audio is playing.
  - ③ Track number indicator
  - ④ Voltage indicator  
Shows the battery voltage.
    - The level displayed on the voltage indicator may differ from the actual voltage level.
  - ⑤ Play time indicator
  - ⑥ Bit rate/sampling frequency indicator  
Shows the bit rate or sampling frequency of the current track (file) when the compressed audio is playing.
    - When playing back VBR (variable bit rate)-recorded WMA files, the average bit rate value is displayed.
    - When playing back VBR (variable bit rate)-recorded MP3 files, **VBR** is displayed instead of bit rate value.
- **Select a folder**  
Push **MULTI-CONTROL** up or down.
    - You cannot select a folder that does not have a compressed audio file recorded in it.
  - **Select a track**  
Push **MULTI-CONTROL** left or right.
  - **Fast forward or reverse**  
Push and hold **MULTI-CONTROL** left or right.
    - When playing compressed audio, there is no sound on fast forward or reverse.

## Operating this unit

### ● Return to root folder

Press and hold **B**.

- If folder 01 (ROOT) contains no files, playback commences with folder 02.

### ● Switch between compressed audio and CD-DA

Press **B**.

- This operation is available only when playing CD-EXTRA or MIXED-MODE CDs.
- If you have switched between compressed audio and CD-DA, playback starts at the first track on the disc.

### Note

Playback is carried out in order of file number. Folders are skipped if they contain no files. (If folder 01 (ROOT) contains no files, playback commences with folder 02.)













## Displaying text information on disc

### ● Press D/Scrl to select the desired text information.













#### ● For title entered CD

Play time—: disc title and play time

#### ● For CD TEXT discs

Play time—: disc artist name and  : track title—: disc artist name and  : disc title—: disc title and  : track title—: track artist name and  : track title—: track title and play time— : track title, : track artist name and : disc title

#### ● For WMA/MP3/AAC

Play time—: folder name and : file name—: artist name and  : track title—: artist name and : album title—: album title and  : track title— : track title and play time—: comment and play time—: track title, : artist name and : album title

#### ● For WAV

Play time—: folder name and : file name

### Notes

- You can scroll through text data by pressing and holding **D/Scrl**.
- Audio CD that contains certain information such as text and/or number is CD TEXT.
- If specific information is not recorded on a disc, title or name is not displayed.
- Depending on the version of iTunes used to write MP3 files onto a disc, comment information may not be correctly displayed.
- Depending on the version of Windows Media™ Player used to encode WMA files, album names and other text information may not be correctly displayed.
- The sampling frequency shown in the display may be abbreviated.
- When Ever Scroll is set to ON at the initial setting, text information scrolls continuously in the display. Refer to *Switching the ever scroll* on page 39.
- Depending on the character sets in the disc, Russian texts may be garbled. About the allowed character sets for Russian texts, refer to *Compressed audio files on the disc* on page 71.

## Selecting tracks from the track title list

Track title list lets you see the list of track titles on a CD TEXT disc and select one of them to play back.

### ● Use MULTI-CONTROL to select the desired track title.

Turn to change the track title. Press to play.

- You can scroll through text data by pressing and holding **D/Scrl**.
- To return to the ordinary display, press **B**.
- If you do not operate the list within about 30 seconds, the display automatically returns to the ordinary display.

## Selecting files from the file name list

File name list lets you see the list of file names (or folder names) and select one of them to playback.

### ● Use MULTI-CONTROL to select the desired file name (or folder name).

Turn to change the name of file or folder.

- when a file is selected, press to play.
- when a folder is selected, press to see a list of files (or folders) in the selected folder.
- when a folder is selected, press and hold to play a song in the selected folder.

- You can also play the file by pushing

**MULTI-CONTROL** right.

- To return to the previous list (the folder one level higher), push **MULTI-CONTROL** left.
- Number of the folders/files in the currently selected folder will be indicated on the right side of the display.
- You can scroll through text data by pressing and holding **D/Scrl**.
- To return to the ordinary display, press **B**.
- If you do not operate the list within about 30 seconds, the display automatically returns to the ordinary display.

## Introduction to advanced operations

### 1 Press MULTI-CONTROL to display the main menu.

### 2 Use MULTI-CONTROL to select FUNCTION.

Turn to change the menu option. Press to select.

### 3 Turn MULTI-CONTROL to select the function.

**Play mode** (repeat play)—**Random mode** (random play)—**Scan mode** (scan play)—**Pause** (pause)—**TitleInput "A"** (disc title input)



### Notes

- To return to the ordinary display, press **B**.
- If you do not operate functions except for **TitleInput "A"** within about 30 seconds, the display automatically returns to the ordinary display.
- When playing a compressed audio disc or CD TEXT disc, you cannot switch to disc title input display.

## Selecting a repeat play range

### 1 Use MULTI-CONTROL to select Play mode in the function menu.

Refer to *Introduction to advanced operations* on this page.

### 2 Press MULTI-CONTROL to select your favorite setting.

- **Disc repeat** – Repeat all tracks
- **Track repeat** – Repeat the current track
- **Folder repeat** – Repeat the current folder
  - If you select another folder during repeat play, the repeat play range changes to disc repeat.
  - Performing track search or fast forward/reverse during **Track repeat** (track repeat) changes the repeat play range to **Disc repeat/ Folder repeat**.
  - When **Folder repeat** (folder repeat) is selected, it is not possible to play back a subfolder of that folder.

## Playing tracks in random order

Tracks in a selected repeat range are played in random order.

### 1 Use MULTI-CONTROL to select Random mode in the function menu.

Refer to *Introduction to advanced operations* on this page.

### 2 Press MULTI-CONTROL to turn random play on.

Tracks play in a random order.

- To turn random play off, press **MULTI-CONTROL** again.



## Operating this unit

### Scanning folders and tracks

Scan play searches the song within the selected repeat range.

#### 1 Use MULTI-CONTROL to select Scan mode in the function menu.

Refer to *Introduction to advanced operations* on the previous page.

#### 2 Press MULTI-CONTROL to turn scan play on.

The first 10 seconds of each track is played.

#### 3 When you find the desired track press MULTI-CONTROL to turn scan play off.

- If the display has automatically returned to the playback display, select **Scan mode** again by using **MULTI-CONTROL**.
- After scanning of a disc (folder) is finished, normal playback of the tracks begins.

### Pausing playback

#### 1 Use MULTI-CONTROL to select Pause in the function menu.

Refer to *Introduction to advanced operations* on the previous page.

#### 2 Press MULTI-CONTROL to turn pause on.

Playback of the current track pauses.

- To turn pause off, press **MULTI-CONTROL** again.

### Using disc title functions

You can input CD titles and display the title. The next time you insert a CD for which you have entered a title, the title of that CD is displayed.

#### Entering disc titles

Use the disc title input feature to store up to 48 CD titles in the unit. Each title can be up to 10 characters long.

#### 1 Play the CD that you want to enter a title for.

#### 2 Use MULTI-CONTROL to select TitleInput "A" in the function menu.

Refer to *Introduction to advanced operations* on the previous page.

#### 3 Press D/Scrl to select the desired character type.

Press **D/Scrl** repeatedly to switch between the following character types:  
 Alphabet (upper case), numbers and symbols  
 —Alphabet (lower case)—European letters, such as those with accents (e.g. á, à, ä, ç)—  
 Numbers and symbols

#### 4 Push MULTI-CONTROL up or down to select a letter of the alphabet.

#### 5 Push MULTI-CONTROL left or right to move the cursor to the previous or next character position.

#### 6 Move the cursor to the last position by pushing MULTI-CONTROL right after entering the title.

When you push **MULTI-CONTROL** right one more time, the entered title is stored in memory.

#### 7 Press B to return to the playback display.



#### Notes

- Titles remain in memory, even after the disc is removed from the unit, and are recalled when the disc is reinserted.
- After data for 48 discs are stored in the memory, data for a new disc overwrites the oldest one.
- If you connect a multi-CD player, you can input disc titles for up to 100 discs.
- When a multi-CD player that does not support disc title functions is connected, you cannot enter disc titles in this unit.

## Playing songs in a USB storage device

You can play compressed audio files stored in a USB storage device.

- For details about compatibility, refer to *Additional Information* on page 68.

### Basic Operations

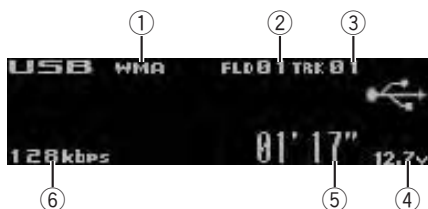

- ① **WMA/MP3/AAC/WAV** indicator  
Shows the type of file currently playing.
- ② Folder number indicator
- ③ Track number indicator
- ④ Voltage indicator  
Shows the battery voltage.
  - The level displayed on the voltage indicator may differ from the actual voltage level.
- ⑤ Play time indicator
- ⑥ Bit rate/sampling frequency indicator
  - When playing back VBR (variable bit rate)-recorded WMA files, the average bit rate value is displayed.
  - When playing back VBR (variable bit rate)-recorded MP3 files, **VBR** is displayed instead of bit rate value.

#### ● **Plugging a USB storage device and playing**

- 1 Plug a USB storage device into the USB port.  
Regarding the position of USB port, refer to *Head unit* on page 10.
- 2 Press **SRC/Off** to select **USB** as a source.  
Playback will start.

#### ● **Select a folder**

Push **MULTI-CONTROL** up or down.

#### ● **Fast forward or reverse**

Push and hold **MULTI-CONTROL** left or right.

#### ● **Select a track**

Push **MULTI-CONTROL** left or right.

#### ● **Return to root folder**

Press and hold **B**.

#### ● **Unplugging a USB storage device**

Pull out the USB storage device.

You can disconnect the USB storage device anytime you want to finish listening to it.

#### **Notes**

- Read the precautions for USB storage devices and this unit in the following section. Refer to *Additional Information*.
- If an error message is displayed, refer to *Error messages* on page 68.
- If folder 01 (ROOT) contains no files, playback commences with folder 02.
- When the USB portable audio player having battery charging function is connected to this unit and the ignition switch is set to ACC or ON, the battery is charged.

### Displaying text information of an audio file

The operation is the same as that of the built-in CD player.

Refer to *Displaying text information on disc* on page 15.

- If the characters recorded on the audio file are not compatible with the head unit, those characters are not displayed.
- The text information of some audio files may not be correctly displayed.

### Selecting files from the file name list

The operation is the same as that of the built-in CD player.

Refer to *Selecting files from the file name list* on page 16.

## Operating this unit

### Introduction to advanced operations

**1 Press MULTI-CONTROL to display the main menu.**

**2 Use MULTI-CONTROL to select FUNCTION.**

Turn to change the menu option. Press to select.

**3 Turn MULTI-CONTROL to select the function.**

**Play mode** (repeat play)—**Random mode**

(random play)—**Scan mode** (scan play)—

**Pause** (pause)

- If you perform track search or fast forward/reverse during **Track repeat**, the repeat play range changes to **Folder repeat**.
- When **Folder repeat** is selected, it is not possible to play back a subfolder of that folder.
- After file or folder scanning is finished, normal playback of the files begins again.
- If you do not operate functions within about 30 seconds, the display automatically returns to the ordinary display. 

### Function and operation

**Play mode**, **Random mode**, **Scan mode** and **Pause** operations are basically the same as that of the built-in CD player.

Function name	Operation
<b>Play mode</b>	Refer to <i>Selecting a repeat play range</i> on page 16. However, the repeat play ranges you can select are different from that of the built-in CD player. The repeat play ranges of the USB storage device are: <ul style="list-style-type: none"> <li>• <b>Track repeat</b> – Repeat just the current file</li> <li>• <b>Folder repeat</b> – Repeat the current folder</li> <li>• <b>All repeat</b> – Repeat all files</li> </ul>
<b>Random mode</b>	Refer to <i>Playing tracks in random order</i> on page 16.
<b>Scan mode</b>	Refer to <i>Scanning folders and tracks</i> on page 17.
<b>Pause</b>	Refer to <i>Pausing playback</i> on page 17.

### Notes

- To return to the ordinary display, press **B**.
- If you select another folder during repeat play, the repeat play range changes to **All repeat**.

## Playing songs on iPod

You can control and listen to songs on an iPod.

- For details about the supported iPod, refer to *iPod compatibility* on page 72.
- When using an iPod, iPod Dock Connector to USB Cable is required.

## Basic Operations

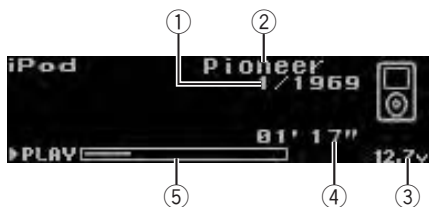

- ① Song number indicator
- ② iPod name
- ③ Voltage indicator  
Shows the battery voltage.
  - The level displayed on the voltage indicator may differ from the actual voltage level.
- ④ Play time indicator
- ⑤ Song time (progress bar)

### ● Connecting an iPod

- 1 Plug an iPod into the USB port using the iPod Dock Connector to USB Cable. Regarding the position of USB port, refer to *Head unit* on page 10.
- 2 Press **SRC/Off** to select **iPod** as a source. Playback will start.

### ● Fast forward or reverse

Push and hold **MULTI-CONTROL** left or right.

### ● Select a track (chapter)

Push **MULTI-CONTROL** left or right.

### ● Disconnecting an iPod

Pull out the iPod Dock Connector to USB Cable.

### Notes

- Read the precautions for iPod in the following section. Refer to page 72.

- If an error message is displayed, refer to *Error messages* on page 68.
- When the ignition switch is set to ACC or ON, the iPod's battery is charged while the iPod is connected to this unit.
- While the iPod is connected to this unit, the iPod cannot be turned on or off. However when the control mode is set to **iPod**, you can turn the iPod on or off.
- Before connecting the iPod to this unit, disconnect the headphones from the iPod.
- The iPod is turned off about two minutes after the ignition switch is set to OFF.

## Browsing for a song

Operations to control an iPod with this unit is designed to be as close to the iPod as possible to make operation and song search easy.

- Depending on the number of files in the iPod, there may be a delay when displaying a list.
- If the characters recorded on the iPod are not compatible with this unit, those characters are not displayed.

## Searching songs by category

### ● Use **MULTI-CONTROL** to select a song.

Turn to change the category. Press to select.

**Playlists** (playlists)—**Artists** (artists)—**Albums** (albums)—**Songs** (songs)—**Podcasts** (podcasts)—**Genres** (genres)—**Composers** (composers)—**Audiobooks** (audiobooks)  
List for the selected category is displayed.

- You can start playback throughout the selected category by pressing and holding **MULTI-CONTROL**. You can also perform this operation by pushing and holding **MULTI-CONTROL** right.
  - You can also change the category by pushing **MULTI-CONTROL** up or down.
  - You can also select the category by pushing **MULTI-CONTROL** right.
    - To return to the previous category, push **MULTI-CONTROL** left.
    - To return to the top tier of categories, push and hold **MULTI-CONTROL** left.

## Operating this unit

- You can scroll through text data by pressing and holding **D/Scrl**.
- To return to the ordinary display, press **B**.
- If you do not operate the list within about 30 seconds, the display automatically returns to the ordinary display.

### Searching by alphabet in the list

**1 Use MULTI-CONTROL to select a category.**

Turn to change the category. Press to select.

**2 When a list for the selected category is displayed, press D/Scrl to switch to alphabet search mode.**

**3 Turn MULTI-CONTROL to select a letter of the alphabet.**

**4 Press MULTI-CONTROL to display the alphabetical list.**

The list is displayed starting from the selected letter of the alphabet.

- If alphabet search is aborted, **NOT FOUND** is displayed.

### Displaying text information on iPod

● **Press D/Scrl to select the desired text information.**

Play time—: artist name and : song title  
—: artist name and : album name—:  
album name and : song title—: song title  
and play time—: song title, : artist name  
and : album name

- You can scroll through text data by pressing and holding **D/Scrl**.
- If the characters recorded on the iPod are not compatible with this unit, those characters are not displayed.
- When Ever Scroll is set to ON at the initial setting, text information scrolls continuously in the display. Refer to *Switching the ever scroll* on page 39.

## Introduction to advanced operations

**1 Press MULTI-CONTROL to display the main menu.**

**2 Use MULTI-CONTROL to select FUNCTION.**

Turn to change the menu option. Press to select.

**3 Turn MULTI-CONTROL to select the function.**

**Play mode** (repeat play)—**Shuffle mode** (shuffle)—**Shuffle all** (shuffle all)—**Link play** (link play)—**Control mode** (control mode)—**Pause** (pause)—**Audiobooks** (audiobook speed)

### Function and operation

**Play mode** and **Pause** operations are basically the same as that of the built-in CD player.

Function name	Operation
<b>Play mode</b>	Refer to <i>Selecting a repeat play range</i> on page 16. However, the repeat play ranges you can select are different from that of the built-in CD player. The repeat play ranges of the iPod are: <ul style="list-style-type: none"> <li>• <b>Repeat One</b> – Repeat the current song</li> <li>• <b>Repeat All</b> – Repeat all songs in the selected list</li> </ul>
<b>Pause</b>	Refer to <i>Pausing playback</i> on page 17.



### Notes

- To return to the ordinary display, press **B**.
- If you do not operate functions within about 30 seconds, the display automatically returns to the ordinary display.
- When **Control mode** is set to **iPod**, only **Control mode** and **Pause** can be operated.

## Operating this unit

### Playing songs in a random order (shuffle)

#### 1 Use MULTI-CONTROL to select Shuffle mode in the function menu.

Refer to *Introduction to advanced operations* on the previous page.

#### 2 Press MULTI-CONTROL to select your favorite setting.

- **Shuffle Songs** – Play back songs in the selected list in random order.
- **Shuffle Albums** – Play back songs from a randomly selected album in order.
- **Shuffle OFF** – Cancel random play.

### Playing all songs in a random order (shuffle all)

#### 1 Use MULTI-CONTROL to select Shuffle all in the function menu.

Refer to *Introduction to advanced operations* on the previous page.

#### 2 Press MULTI-CONTROL to turn shuffle all on.

All songs on the iPod play randomly.

- To turn shuffle all off, set **Shuffle mode** in the **FUNCTION** menu to off.

### Playing songs related to the currently playing song

Songs related to the currently playing song are played. You can play songs of the following lists.

- Album list of currently playing artist
- Song list of currently playing album
- Album list of currently playing genre
- Depending on the number of files in the iPod, there may be a delay when displaying a list.

#### 1 Use MULTI-CONTROL to select Link play in the function menu.

Refer to *Introduction to advanced operations* on the previous page.

#### 2 Use MULTI-CONTROL to select the desired mode.

Push **MULTI-CONTROL** left or right to change the mode; press to select.

- **Artist** – Plays the album of currently playing artist.
- **Album** – Plays the song of currently playing album.
- **Genre** – Plays the album of currently playing genre.

**Searching** flashes while searching the list and then the playback of the list starts.

- If the related albums/songs are not found, **Not found** is displayed.

### Operating this unit's iPod function from your iPod

*This function cannot be operated with the following iPod models.*

— iPod nano first generation

— iPod fifth generation

This unit's iPod function can be operated from your iPod. Sound can be heard from the car's speakers, and operation can be conducted from your iPod.

- While this function is in use, even if the ignition key is turned off, the iPod will not be turned off. To turn off power, operate the iPod.

#### 1 Use MULTI-CONTROL to select Control mode in the function menu.

Refer to *Introduction to advanced operations* on the previous page.

#### 2 Press MULTI-CONTROL to select your favorite setting.

- **iPod** – This unit's iPod function can be operated from the connected iPod.
- **AUDIO** – This unit's iPod function can be operated from this unit.

#### 3 When you select iPod, operate the connected iPod to select a song and play.

- Switching the control mode to **iPod** pauses song playback. Operate the iPod to start playback.
- Even if the control mode is set to **iPod**, following functions are available from this unit.

## Operating this unit

- Volume
- Fast forward/reverse
- Track up/down
- Pausing
- Switching the text information



### Notes

- When the control mode is set to **iPod**, operations are limited as follows:
  - Functions other than **Control mode** (control mode) and **Pause** (pause) cannot be selected.
  - Browse function cannot be operated from this unit.
- Turning this function on pauses song playback. Operate the iPod to start playback.

## Changing audiobook speed

While listening to an audiobook on iPod, playback speed can be changed.

### 1 Use MULTI-CONTROL to select Audiobooks in the function menu.

Refer to *Introduction to advanced operations* on page 21.

### 2 Press MULTI-CONTROL to select your favorite setting.

Press **MULTI-CONTROL** repeatedly until the desired setting appears in the display.

- **Faster** – Playback faster than normal speed
- **Normal** – Playback in normal speed
- **Slower** – Playback slower than normal speed 

## Operation modes

This unit's 4-way network DSP lets you create a 4-way multi-amp, multi-speaker system with separate speakers for reproduction of high, middle, low and ultra-low frequencies (bands), each driven by a dedicated power amp. The 4-way network mode provides network and time alignment functions. These two functions are essential for a multi-amp, multi-speaker system to enable precise control over settings for each frequency range.



### Important

Even when the battery is disconnected or the microprocessor is reset, this unit's audio setting remains in the memory. If you want to reset the audio setting, refer to *Resetting the audio functions* on page 38.



### Note

If one subwoofer is used with this system, left and right channel adjustment values, such as time alignment and network settings, need to be the same.

## Adjusting the audio easily

By carrying out the following settings/adjustments in the order shown, you can create a finely-tuned sound field effortlessly.

- ① *Using the position selector (POSI)*
- ② *Auto TA and EQ (auto-time alignment and auto-equalizing)*
- ③ *Using balance adjustment on the next page (BAL)*

## Adjusting the audio finely

By carrying out the following settings/adjustments in the order shown, you can create a finely-tuned sound field.

- ① *Adjusting the time alignment (TA2)*
- ② *Adjusting network (NW 1, NW 2, NW 3)*
- ③ *Fine-adjusting equalizer curve (EQ 2)*

## Extra functions

These functions are helpful in adjusting the sound to suit your system or your personal preferences.

- *Recalling or copying equalizer curves (EQ 1)*
- *Adjusting loudness (LOUD)*
- *Using the sound retriever (S.Rtrv)*
- *Adjusting source levels (SLA)* 

## Introduction of audio adjustments

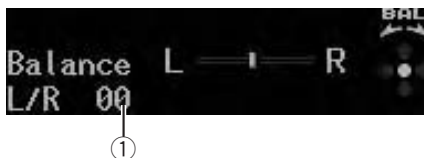

- ① **Audio display**  
Shows the audio adjustment status.

**1 Press MULTI-CONTROL to display the main menu.**

**2 Use MULTI-CONTROL to select AUDIO.**  
Turn to change the menu option. Press to select.

**3 Turn MULTI-CONTROL to select the audio function.**

Turn **MULTI-CONTROL** to switch between the audio functions in the following order.

**BAL** (balance adjustment)—**POSI** (position selector)—**NW 1** (network adjustment 1)—**NW 2** (network adjustment 2)—**NW 3** (network adjustment 3)—**TA1** (time alignment setting)—**TA2** (time alignment adjusting)—**EQ 1** (copying/recalling the equalizer)—**EQ 2** (31-band graphic equalizer)—**A.EQ** (auto-equalizer on/off)—**S.Rtrv** (advanced sound retriever)—**LOUD** (loudness)—**SLA** (source level adjustment)

- When selecting FM as the source, you cannot switch to **SLA**.
- When selecting **FLAT** in **EQ 1**, you cannot switch to **EQ 2**.
- When selecting **OFF** in **TA1**, you cannot switch to **TA2**.
- To return to the display of each source, press **B**. 



## Audio Adjustments

### Switching left and right channel

You can adjust following functions for left and right channel independently or commonly.

- *Adjusting network (NW 1, NW 2, NW 3)*
- *Fine-adjusting equalizer curve (EQ 2)*

**1 Use MULTI-CONTROL to select the audio function described above.**

**2 Press MULTI-CONTROL and hold to switch between left/right independent mode and left/right common mode.**

Each pressing and holding **MULTI-CONTROL** selects left/right independent mode and left/right common mode.

**3 Press MULTI-CONTROL to select left channel or right channel when left/right independent mode has been selected.**

Each pressing **MULTI-CONTROL** selects left channel and right channel.

**4 Adjust these functions as desired.**

### Using balance adjustment

You can select a balance setting that provides an ideal listening environment in all occupied seats.

**1 Use MULTI-CONTROL to select BAL in the audio function menu.**

Refer to *Introduction of audio adjustments* on the previous page.

**2 Push MULTI-CONTROL left or right to adjust left/right speaker balance.**

Each time **MULTI-CONTROL** is pushed left or right, the left/right speaker balance moves towards the left or right.

**L 25 to R 25** is displayed as the left/right speaker balance moves from left to right.

### Using the position selector

One way to assure a more natural sound is to clearly position the stereo image, putting you right in the center of the sound field. The position selector function lets you automatically adjust the speakers' output levels and inserts

a delay time to match the number and position of occupied seats.

**1 Use MULTI-CONTROL to select POS1 in the audio function menu.**

Refer to *Introduction of audio adjustments* on the previous page.

**2 Push MULTI-CONTROL left, right or up to select a listening position.**

Direction	Display	Position
Left	<b>Left</b>	Front seat left
Right	<b>Right</b>	Front seat right
Up	<b>Front</b>	Front seats

- To cancel the selected listening position, push **MULTI-CONTROL** in the same direction again.

### About the network function

The network function lets you divide the audio signal into different frequency bands, and then reproduce each of them through separate speaker units.

You can then make precise adjustments to the reproduced frequency band (with a low-pass filter or high-pass filter), level, phase and other parameters to match the characteristics of each speaker unit.

## Adjustable parameters

The network function enables adjustment of the following parameters. Make adjustments in line with the reproduced frequency band and characteristics of each connected speaker unit.

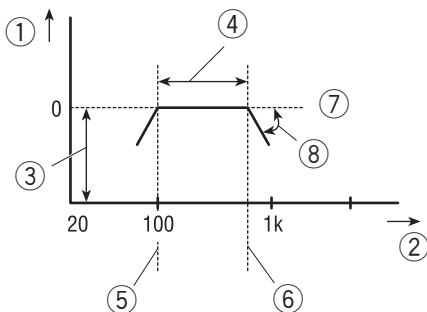

- ① Level (dB)
- ② Frequency (Hz)
- ③ Level
- ④ Reproduced frequency band
- ⑤ Cut-off frequency of HPF
- ⑥ Cut-off frequency of LPF
- ⑦ Pass
- ⑧ Slope (dB/oct.)

## Reproduced frequency band

Adjusting the HPF (high-pass filter) or LPF (low-pass filter) cut-off frequency lets you set the reproduced frequency band for each speaker unit.

- The HPF cuts frequencies (low) below the set frequency, letting high frequencies through.
- The LPF cuts frequencies (high) above the set frequency, letting low frequencies through.

## Level

The difference in reproduced levels between speaker units can be corrected.

## Slope

Adjusting the HPF/LPF slope (filter attenuation slope) lets you adjust the continuity of sound between speaker units.

- The slope indicates the number of decibels (dB) the signal is attenuated when the frequency is one octave higher (lower) (Unit: dB/oct.). The steeper the slope, the more the signal is attenuated.

## Phase

You can switch phase (normal, reverse) for each speaker unit's input signal. When the continuity of sound between speakers is imprecise, try switching phase. This may improve the continuity of sound between speakers.

## Points concerning network adjustments

### Cut-off frequency adjustment

- If you set the **Low-LPF** or **SW-LPF** cut-off frequency at a high level with a low-range speaker or subwoofer installed in the rear of the vehicle, the bass sound is separated so it sounds like it is coming from the rear. Setting the **Low-LPF** or **SW-LPF** cut-off frequency to 100 Hz or lower is recommended.
- The maximum input power setting for middle- and high-range speakers is usually lower than low-range speakers. Please be aware that if the **Mid-HPF** or **High-HPF** cut-off frequency is set lower than required, strong bass signal input may damage the speaker.

### Level adjustment

The basic frequencies of many musical instruments are in the middle range. First perform middle-range level adjustment, followed by high-range and then low-range and subwoofer level adjustment in that order.

### Slope adjustment

- If you set a small absolute value for the slope (for a gentle slope), interference between adjacent speaker units can easily result in degraded frequency response.

## Audio Adjustments

- If you set a large absolute value for the slope (for a steep slope), continuity of sound between speaker units is degraded, and sounds appear to be separated.
- If you set the slope to 0 dB/oct. (pass), the audio signal bypasses the filter, so the filter does not have an effect.

### Phase adjustment

When the cross-over point value for filters on both sides is set to  $-12$  dB/oct., the phase is reversed 180 degrees at the filter cut-off frequency. In this case, reversing the phase assures improved sound continuity.

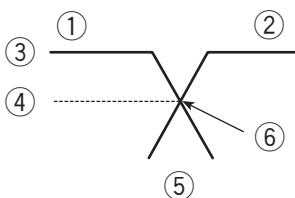

- ① Normal phase
- ② Reverse phase
- ③ 0 dB
- ④  $-3$  dB
- ⑤  $-12$  dB
- ⑥ Crossover point

### Muting the speaker unit (filter)

You can mute each speaker unit (filter). When a speaker unit (filter) is muted, no sound is outputted from that speaker.

- If you mute the selected speaker unit (filter), **MUTE** blinks and no adjustments are possible.
- Even if any speaker unit (filter) is muted, you can adjust the parameters for other speaker units (filters).

#### 1 Use MULTI-CONTROL to select NW 1 in the audio function menu.

Refer to *Introduction of audio adjustments* on page 24.

#### 2 Push MULTI-CONTROL left or right to select the speaker unit (filter) to be adjusted.

Each time **MULTI-CONTROL** is pushed left or right, the speaker unit (filter) is selected in the following order:

**SW-HPF** (subwoofer HPF)—**SW-LPF** (subwoofer LPF)—**Low-HPF** (low-range speaker HPF)—**Low-LPF** (low-range speaker LPF)—**Mid-HPF** (middle-range speaker HPF)—**Mid-LPF** (middle-range speaker LPF)—**High-HPF** (high-range speaker HPF)—**High-LPF** (high-range speaker LPF)

#### 3 Push and hold MULTI-CONTROL down to mute the selected speaker unit (filter).

- To cancel the muting, push **MULTI-CONTROL** up.

### Adjusting network

#### 1 Use MULTI-CONTROL to select NW 1 in the audio function menu.

Refer to *Introduction of audio adjustments* on page 24.

#### 2 Push MULTI-CONTROL left or right to select the speaker unit (filter) to be adjusted.

Each time **MULTI-CONTROL** is pushed left or right, the speaker unit (filter) is selected in the following order:

**SW-HPF** (subwoofer HPF)—**SW-LPF** (subwoofer LPF)—**Low-HPF** (low-range speaker HPF)—**Low-LPF** (low-range speaker LPF)—**Mid-HPF** (middle-range speaker HPF)—**Mid-LPF** (middle-range speaker LPF)—**High-HPF** (high-range speaker HPF)—**High-LPF** (high-range speaker LPF)

#### 3 Turn MULTI-CONTROL to select NW 2 in the audio function menu.

Refer to *Introduction of audio adjustments* on page 24.

## Audio Adjustments

### 4 Push MULTI-CONTROL left or right to select the cut-off frequency (crossover frequency) of the selected speaker unit (filter).

Each time **MULTI-CONTROL** is pushed left or right, cut-off frequencies (crossover frequencies) are selected in the following order:

- **High-LPF**  
5k—6.3k—8k—10k—12.5k—16k—20k
- **High-HPF**  
800Hz—1k—1.25k—1.6k—2k—2.5k—  
3.15k—4k—5k—6.3k—8k—10k—12.5k—  
16k
- **Mid-LPF, Low-LPF and SW-LPF**  
25Hz—31.5Hz—40Hz—50Hz—63Hz—  
80Hz—100Hz—125Hz—160Hz—200Hz—  
250Hz—315Hz—400Hz—500Hz—630Hz—  
800Hz—1k—1.25k—1.6k—2k—2.5k—  
3.15k—4k—5k—6.3k—8k—10k—12.5k—  
16k—20k
- **Mid-HPF, Low-HPF and SW-HPF**  
20Hz—25Hz—31.5Hz—40Hz—50Hz—  
63Hz—80Hz—100Hz—125Hz—160Hz—  
200Hz—250Hz—315Hz—400Hz—500Hz—  
630Hz—800Hz—1k—1.25k—1.6k—2k—  
2.5k—3.15k—4k—5k—6.3k—8k—10k—  
12.5k—16k

▪ You cannot select speakers that are set to off in the initial setting. Refer to *Setting the speakers* on page 35.

### 5 Push MULTI-CONTROL up or down to adjust the level of the selected speaker unit (filter).

Each time **MULTI-CONTROL** is pushed up or down, the level of the selected speaker unit (filter) increases or decreases.

**0 dB to -24 dB** is displayed as the level is increased or decreased if you have selected **High-LPF, High-HPF, Mid-LPF or Mid-HPF**.  
**6 dB to -24 dB** is displayed as the level is increased or decreased, only if you have selected **Low-LPF, Low-HPF, SW-LPF or SW-HPF**.

### 6 Turn MULTI-CONTROL to select NW 3 in the audio function menu.

Refer to *Introduction of audio adjustments* on page 24.

### 7 Push MULTI-CONTROL left or right to select the slope of the selected speaker unit (filter).

Each time **MULTI-CONTROL** is pushed left or right, slopes are selected in the following order:

- **High-HPF**  
6dB/oct.—12dB/oct.—18dB/oct.—  
24dB/oct.—30dB/oct.—36dB/oct.
- **High-LPF, Mid-LPF, Mid-HPF, Low-LPF, Low-HPF, SW-LPF and SW-HPF**  
Pass—6dB/oct.—12dB/oct.—18dB/oct.—  
24dB/oct.—30dB/oct.—36dB/oct.

### 8 Push MULTI-CONTROL up or down to switch the phase of the selected speaker unit (filter).

Push **MULTI-CONTROL** up selects normal phase and **NOR** appears in the display. Push **MULTI-CONTROL** down selects reverse phase and **REV** appears in the display.

▪ You can adjust the parameters for other speaker units (filters) in the same way.

### 9 Press B to cancel the network adjustment mode.

## Using the time alignment

The time alignment lets you adjust the distance between each speaker and the listening position.

### 1 Use MULTI-CONTROL to select TA1 in the audio function menu.

Refer to *Introduction of audio adjustments* on page 24.

## Audio Adjustments

### 2 Push MULTI-CONTROL left or right to select the time alignment.

Each time **MULTI-CONTROL** is pushed left or right, time alignment is selected in the following order:

**Initial** (initial)—**Custom** (custom)—**AutoTA** (auto-time alignment)—**OFF** (off)

- **Initial** is the factory supplied time alignment.
- **Custom** is an adjusted time alignment that you created.
- **AutoTA** is the time alignment created by auto TA and EQ. (Refer to *Auto TA and EQ (auto-time alignment and auto-equalizing)* on page 31.)

■ You cannot select **AutoTA** if auto TA and EQ has not been carried out. In this case,

**Please Set Auto TA** appears.

### Adjusting the time alignment

You can adjust the distance between each speaker and the selected position.

- An adjusted time alignment is memorized in **Custom**.

#### 1 Use MULTI-CONTROL to select TA1 in the audio function menu.

Refer to *Introduction of audio adjustments* on page 24.

#### 2 Press MULTI-CONTROL to select a unit of distance.

Each press of **MULTI-CONTROL** selects the unit of distance in the following order:

**(cm)** (centimeter)—**(inch)** (inch)

#### 3 Use MULTI-CONTROL to select TA2 in the audio function menu.

Refer to *Introduction of audio adjustments* on page 24.

- **Can't Adjust TA. Set POS. FL or FR** appears when neither **Left** nor **Right** is selected in the position selector mode (**POSI**).
- When selecting **OFF** in **TA1**, you cannot switch to **TA2**.

### 4 Push MULTI-CONTROL left or right to select the speaker to be adjusted.

Each time **MULTI-CONTROL** is pushed left or right, the speaker is selected in the following order:

**High L** (high-range left)—**High R** (high-range right)—**Mid L** (middle-range left)—**Mid R** (middle-range right)—**Low L** (low-range left)—**Low R** (low-range right)—**SW L** (subwoofer left)—**SW R** (subwoofer right)

### 5 Push MULTI-CONTROL up or down to adjust the distance between the selected speaker and the listening position.

Each time **MULTI-CONTROL** is pushed up or down, the distance increases or decreases.

**394.75cm** to **0.00cm** is displayed as the distance is increased or decreased, if you have selected centimeters (**(cm)**).

**155.39inch** to **0.00inch** is displayed as the distance is increased or decreased, if you have selected inches (**(inch)**).

- You can adjust the distance for the other speakers in the same way.

### 6 Press B to cancel the time alignment mode.

## Recalling or copying equalizer curves

The equalizer lets you adjust the equalization to match the car's interior acoustic characteristics as desired.

It is possible to store the adjusted equalizer curve in the memory, or recall the stored equalizer curve from the memory.

### Recalling the equalizer curve

#### 1 Use MULTI-CONTROL to select EQ 1 in the audio function menu.

Refer to *Introduction of audio adjustments* on page 24.

## Audio Adjustments

### 2 Push MULTI-CONTROL left or right to select the equalizer curve you want to recall.

Each time **MULTI-CONTROL** is pushed left or right, equalizer curve is recalled in the following order.

**MEMORY1** (memory 1)—**MEMORY2** (memory 2)—**MEMORY3** (memory 3)—**MEMORY4** (memory 4)—**MEMORY5** (memory 5)—**FLAT** (flat)

- When **FLAT** is selected, no supplement or correction is made to the sound. This is useful to check the effect of the equalizer curves by switching alternatively between **FLAT** and a set equalizer curve.

## Copying the equalizer curve

### 1 Use MULTI-CONTROL to select EQ 1 in the audio function menu.

Refer to *Introduction of audio adjustments* on page 24.

### 2 Push MULTI-CONTROL left or right to select the equalizer curve you want to copy.

### 3 Press MULTI-CONTROL and hold to copy the selected equalizer curve.

### 4 Push MULTI-CONTROL left or right to select the storage area (MEMORY1 to MEMORY5).

### 5 Press MULTI-CONTROL and hold to store the equalizer curve.

## Fine-adjusting equalizer curve

You can perform 31-band level adjustment to achieve the optimum acoustic characteristics for your vehicle's interior environment.

### 1 Select the storage area (MEMORY1 to MEMORY5).

Refer to *Copying the equalizer curve* on this page.

- If an equalizer curve has already been stored in memory, it will be overwritten by the newly adjusted equalizer curve.

### 2 Use MULTI-CONTROL to select EQ 2 in the audio function menu.

Refer to *Introduction of audio adjustments* on page 24.

### 3 Push MULTI-CONTROL left or right to select the equalizer band to adjust.

Each time **MULTI-CONTROL** is pushed left or right, equalizer bands are selected in the following order.

**20Hz—25Hz—31.5Hz—40Hz—50Hz—63Hz—80Hz—100Hz—125Hz—160Hz—200Hz—250Hz—315Hz—400Hz—500Hz—630Hz—800Hz—1k—1.25k—1.6k—2kHz—2.5k—3.15k—4k—5k—6.3k—8k—10k—12.5kHz—16k—20k**

### 4 Push MULTI-CONTROL up or down to adjust the level of the equalizer band.

Each time **MULTI-CONTROL** is pushed up or down, the level of the equalization band increases or decreases.

**+12** to **-12** is displayed as the level is increased or decreased.

- You can then select another band and adjust the level.

### 5 Equalizer curve is automatically stored in memory.

## Using the auto-equalizer

The auto-equalizer is the equalizer curve created by auto TA and EQ (refer to *Auto TA and EQ (auto-time alignment and auto-equalizing)* on the next page).

You can turn the auto-equalizer on or off.

### 1 Use MULTI-CONTROL to select A.EQ in the audio function menu.

Refer to *Introduction of audio adjustments* on page 24.

## Audio Adjustments

- If auto TA and EQ has not been carried out, **Please Set Auto EQ** appears. This indicates that you cannot turn this function on.

### 2 Press MULTI-CONTROL to turn the auto-equalizer on.

- To turn auto-equalizer off, press **MULTI-CONTROL** again. 

## Using the sound retriever

The sound retriever function automatically enhances compressed audio and restores rich sound.

### 1 Use MULTI-CONTROL to select S.Rtrv in the audio function menu.

Refer to *Introduction of audio adjustments* on page 24.

### 2 Press MULTI-CONTROL to select the desired setting.

**OFF** (off)—**MODE1**—**MODE2**

- **MODE1** is effective for the low compression rate.
- **MODE2** is effective for the high compression rate.
- This function can be used for the audio data stored in a CD, DVD, Bluetooth Audio, iPod, USB or AUX. 

## Adjusting loudness

Loudness compensates for deficiencies in the low- and high-sound ranges at low volume.

### 1 Use MULTI-CONTROL to select LOUD in the audio function menu.

Refer to *Introduction of audio adjustments* on page 24.

### 2 Press MULTI-CONTROL to turn loudness on.

- To turn loudness off, press **MULTI-CONTROL** again. 

## Adjusting source levels

SLA (source level adjustment) lets you adjust the volume level of each source to prevent radical changes in volume when switching between sources.

- Settings are based on the FM volume level, which remains unchanged.

### 1 Compare the FM volume level with the level of the source you wish to adjust.

### 2 Use MULTI-CONTROL to select SLA in the audio function menu.

Refer to *Introduction of audio adjustments* on page 24.

### 3 Push MULTI-CONTROL up or down to adjust the source volume.

Each time **MULTI-CONTROL** is pushed up or down, source volume increases or decreases. **+4** to **-4** is displayed as the source volume is increased or decreased.



#### Notes

- The AM volume level can also be adjusted with source level adjustments.
- The built-in CD player and the multi-CD player are set to the same source level adjustment volume automatically.
- External unit 1 and external unit 2 are set to the same source level adjustment volume automatically. 

## Auto TA and EQ (auto-time alignment and auto-equalizing)

The auto-time alignment is automatically adjusted for the distance between each speaker and the listening position.

The auto-equalizer automatically measures the car interior acoustic characteristics, and then creates the auto-equalizer curve based on that information.

### WARNING

- To prevent accidents, never carry out auto TA and EQ while driving. When this function measures the car interior acoustic characteristics to create an auto-equalizer curve, a loud measurement tone (noise) may be outputted from the speakers.
- Be sure to connect the high-range speakers to the high range output. If the speakers are not connected correctly, they may be damaged by the low frequency measurement tone.

### CAUTION

- Carrying out auto TA and EQ under the following conditions may damage the speakers. Be sure to check the conditions thoroughly before carrying out auto TA and EQ.
  - When speakers are incorrectly connected. (e.g., When a mid-range speaker is connected to a subwoofer output.)
  - When a speaker is connected to a power amp delivering output higher than the speaker's maximum input power capability.
- If the microphone is placed in an unsuitable position the measurement tone may become loud and measurement may take a long time, resulting in a drain on battery power. Be sure to place the microphone in the specified location.
- When tweeters and super-tweeters are connected to this system, be sure to use the super-tweeter's cross-over network.
- When tweeters and super-tweeters are connected to this system, auto-time alignment and auto-equalizing may not operate properly. In this case, manual adjustment is needed.

## Before operating the auto TA and EQ function

- Check the speaker's usable frequency range. Then connect the proper speakers to high, mid, low or subwoofer outputs. If the speakers are not connected correctly, auto-

time alignment and auto-equalizing may not perform properly.

- Carry out auto TA and EQ in as quiet a place as possible, with the car engine and air conditioning switched off. Also cut power to car phones or portable telephones in the car, or remove them from the car before carrying out auto TA and EQ. Sounds other than the measurement tone (surrounding sounds, engine sound, telephones ringing etc.) may prevent correct measurement of the car interior acoustic characteristics.
- Be sure to carry out auto TA and EQ using the supplied microphone. Using another microphone may prevent measurement, or result in incorrect measurement of the car interior acoustic characteristics.
- When the speakers activated in the initial setting menu are not connected, auto TA and EQ cannot be carried out.
- When the mid range speaker units are muted, auto TA and EQ cannot be carried out. (Refer to the next page.)
- When this unit is connected to a power amp with input level control, auto TA and EQ may not be possible if you lower power amp input level. Set the power amp's input level to the standard position.
- When this unit is connected to a power amp with an LPF, turn off the LPF on the power amp before carrying out auto TA and EQ. In addition, the cut-off frequency for built-in LPF of an active subwoofer should be set to the highest frequency.
- The time alignment value calculated by auto TA and EQ may differ from the actual distance in the following circumstances. However, the distance has been calculated by computer to be the optimum delay to give accurate results for the circumstances, so please continue to use this value.
  - When the reflected sound within a vehicle is strong and delays occur.



## Audio Adjustments

- When delays occur for low sounds due to the influence of the LPF on active subwoofers or external amps.
- Auto TA and EQ changes the audio settings as below:
  - The balance settings return to the center position. (Refer to page 25.)
  - The graphic equalizer curve switches to **FLAT**. (Refer to page 29.)
- If you carry out auto TA and EQ when a previous setting of this already exists, the setting will be replaced.
- When connecting tweeters, please confirm the tweeter's usable frequency range. When you set the cut-off frequency, set higher than the lowest usable frequency of the tweeter.
- Auto TA uses higher range than 10 kHz for measurement. Therefore, using the tweeter that cannot reproduce 10 kHz frequency range may damage the tweeter. When Auto TA&EQ is operated, be sure to set the appropriate cut-off frequency. Also, use the tweeter that can reproduce 10 kHz at the lowest usable frequency.
- Speakers used with this system need to be activated in the initial setting menu. Refer to *Setting the speakers* on page 35.
- To perform auto-time alignment and auto-equalizing, be sure to connect speakers to mid range output.

### Carrying out auto TA and EQ

**1 Stop the car in a place that is as quiet as possible, close all doors, windows and the sun roof, and then turn the engine off.**

- If the engine is left running, engine noise may prevent correct auto TA and EQ.

**2 Fix the supplied microphone in the center of the headrest of the driver's seat, facing forward, using the belt (sold separately).**

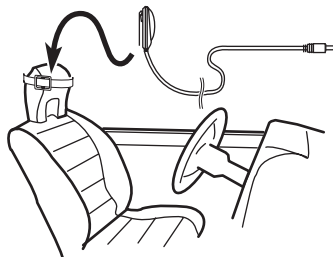

- The auto TA and EQ may differ depending on where you place the microphone. If desired, place the microphone on the front passenger seat to carry out auto TA and EQ.

**3 Turn the ignition switch to ON or ACC.**

- If the car's air conditioner or heater is turned on, turn it off. Noise from the fan in the air conditioner or heater may prevent correct auto TA and EQ.
- Press **SRC/Off** to turn the source on if this unit is turned off.

**4 Press SRC/Off and hold until the unit turns off.**

**5 Press and hold EQ to enter the auto TA and EQ menu.**

The front panel opens automatically.

**6 Plug the microphone into the microphone input jack on this unit.**

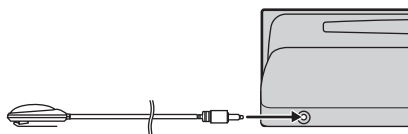

**7 Turn MULTI-CONTROL to select Select position in the auto TA and EQ menu.**

## Audio Adjustments

### 8 Press MULTI-CONTROL to select a position.

Each press of **MULTI-CONTROL** selects settings in the following order:

**Front left** (front left)—**Front right** (front right)

Select the position for the seat on which the microphone is placed.

### 9 Turn MULTI-CONTROL to select Select N/W mode in the auto TA and EQ menu.

### 10 Press MULTI-CONTROL to select a network mode.

Each press of **MULTI-CONTROL** selects settings in the following order:

**Auto N/W** (auto)—**Custom N/W** (custom)

- If you want to carry out auto TA and EQ based on previously customized network settings, select **Custom N/W**. Otherwise, select **Auto N/W**.

- If manually adjusted value is not suitable for the actual specifications of the speakers, auto-time alignment and auto-equalizer may not perform properly.

### 11 Turn MULTI-CONTROL to select Auto TA & EQ stop in the auto TA and EQ menu.

### 12 Press MULTI-CONTROL to start the auto TA and EQ.

### 13 Get out of the car and close the door within 10 seconds when the 10-second count-down starts.

The measurement tone (noise) is outputted from the speakers, and auto TA and EQ begins.

- To stop auto TA and EQ, press

**MULTI-CONTROL** again.

- To cancel auto TA and EQ part way through, press **B**.

### 14 When auto TA and EQ is completed, Complete is displayed.

When correct measurement of car interior acoustic characteristics is not possible, an error message is displayed. (Refer to *Under-*

*standing auto TA and EQ error messages on page 69.*)

### 15 Press B to cancel the auto TA and EQ mode.

### 16 Store the microphone carefully in the glove compartment.

Store the microphone carefully in the glove compartment or any other safe place. If the microphone is subjected to direct sunlight for an extended period, high temperatures may cause distortion, color change or malfunction.



#### Note

Make sure you have disconnected the microphone before pressing **▲/Open** to open or close the panel (an alert sounds if the mic is still connected). 

## Initial Settings

### Adjusting initial settings

Using the initial settings, you can customize various system settings to achieve optimal performance from this unit.

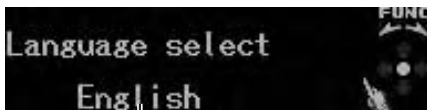

- ① Function display  
Shows the function status.

**1 Press SRC/Off and hold until the unit turns off.**

**2 Press MULTI-CONTROL and hold until the initial setting menu appears in the display.**

**3 Turn MULTI-CONTROL to select one of the initial settings.**

Turn **MULTI-CONTROL** to switch between the functions in the following order.

**Language select** (language selection)—**SP connection** (speaker setting)—**Clock** (clock)—**Warning tone** (warning tone)—**Face auto open** (face auto open)—**AUX1** (auxiliary input 1)—**AUX2** (auxiliary input 2)—**Dimmer** (dimmer)—**Brightness** (brightness)—**Illumination 1** (illumination select)—**Illumination 2** (custom illumination)—**ILL line** (illumination interlock)—**Digital ATT** (digital attenuation)—**Audio Reset** (audio reset)—**Mute** (sound muting/attenuation)—**Door mute 1** (intelligent mute polarity setting)—**Door mute 2** (intelligent mute setting)—**Reverse mode** (reverse mode)—**Ever-scroll** (ever scroll)—**BT AUDIO** (Bluetooth audio)—**Pin code input** (pin code input)—**BT Version Info.** (Bluetooth version information)

Use the following instructions to operate each particular setting.

- **BT AUDIO, Pin code input** and **BT Version Info.** can be selected only when Blue-

tooth adapter (e.g., CD-BTB200) is connected to this unit.

- To cancel initial settings, press **B**.

### Selecting the display language

For your convenience, this unit equips multiple language display. You can select the language best suited to your first language.

**1 Use MULTI-CONTROL to select Language select in the initial setting menu.** Refer to *Adjusting initial settings* on this page.

**2 Press MULTI-CONTROL to select the language.**

Each press of **MULTI-CONTROL** selects languages in the following order:

**English—Français—Español**

### Setting the speakers

You need to set the speakers used with this system.

When this setting is performed correctly, this unit reproduces high-definition sound suited to your system.

- You cannot change the middle-range speaker setting. (The middle-range speaker is always on.)
- If this setting is adjusted after performing auto-time alignment and auto-equalizing function, perform auto-time alignment and auto-equalizing again.

**1 Use MULTI-CONTROL to select SP connection in the initial setting menu.** Refer to *Adjusting initial settings* on this page.

**2 Push MULTI-CONTROL left or right to select the speaker to be adjusted.**

Each time **MULTI-CONTROL** is pushed left or right, the speaker is selected in the following order:

**Subwoofer** (subwoofer)—**Low range** (low range speaker)—**High range** (high range speaker)

## Initial Settings

**3 Press MULTI-CONTROL to turn the selected speaker on.**

- To turn off, press **MULTI-CONTROL** again. 

### Setting the clock

Use these instructions to set the clock.

**1 Use MULTI-CONTROL to select Clock in the initial setting menu.**

Refer to *Adjusting initial settings* on the previous page.

**2 Push MULTI-CONTROL left or right to select the segment of the clock display you wish to set.**

Pushing **MULTI-CONTROL** left or right will select one segment of the clock display:

Hour—Minute

As you select segments of the clock display, the selected segment blinks.

**3 Push MULTI-CONTROL up or down to put a clock right.**

- You can match the clock to a time signal by pressing **MULTI-CONTROL**.
  - If **00** to **29**, the minutes are rounded down. (e.g., **10:18** becomes **10:00**.)
  - If **30** to **59**, the minutes are rounded up. (e.g., **10:36** becomes **11:00**.) 

### Switching the warning tone

If the front panel is not detached from the head unit within four seconds of turning off the ignition, a warning tone sounds. You can turn off the warning tone.

**1 Use MULTI-CONTROL to select Warning tone in the initial setting menu.**

Refer to *Adjusting initial settings* on the previous page.

**2 Press MULTI-CONTROL to turn warning tone on.**

- To turn warning tone off, press **MULTI-CONTROL** again. 

### Switching the face auto open

To protect against theft, this unit features detachable front panel. To detach the front panel easily, the front panel opens automatically. This function is on as a default.

**1 Use MULTI-CONTROL to select Face auto open in the initial setting menu.**

Refer to *Adjusting initial settings* on the previous page.

**2 Press MULTI-CONTROL to turn the face auto open on.**

- To turn the face auto open off, press **MULTI-CONTROL** again. 

### Switching the auxiliary setting

Auxiliary devices connected to this unit can be activated individually. Set each AUX source to ON when using. For more information about connecting or using auxiliary devices, refer to *Using the AUX source* on page 41.

**1 Use MULTI-CONTROL to select AUX1/ AUX2 in the initial setting menu.**

Refer to *Adjusting initial settings* on the previous page.

**2 Press MULTI-CONTROL to turn AUX1/ AUX2 on.**

- To turn AUX off, press **MULTI-CONTROL** again. 

### Switching the dimmer setting

To prevent the display from being too bright at night, the display is automatically dimmed when the car's headlights are turned on. You can turn the dimmer on or off.

**1 Use MULTI-CONTROL to select Dimmer in the initial setting menu.**

Refer to *Adjusting initial settings* on the previous page.

## Initial Settings

**2 Press MULTI-CONTROL to turn dimmer on.**

- To turn dimmer off, press **MULTI-CONTROL** again.

### Adjusting the brightness

You can adjust the display brightness.

**1 Use MULTI-CONTROL to select Brightness in the initial setting menu.**

Refer to *Adjusting initial settings* on page 35.

**2 Push MULTI-CONTROL left or right to adjust the brightness level.**

**0 to 15** is displayed as the level is increased or decreased.

- When dimmer is functioning, the brightness level can be adjusted **0 to 10**.

### Selecting the illumination color

You can select the illumination color from among White, Red, Amber, Green and Blue. Also, you can adjust brightness of each color.

**1 Use MULTI-CONTROL to select Illumination 1 in the initial setting menu.**

Refer to *Adjusting initial settings* on page 35.

**2 Push MULTI-CONTROL left or right to select the desired illumination color.**

Each time **MULTI-CONTROL** is pushed left or right, the illumination color is selected in the following order:

**White** (white)—**Red** (red)—**Amber** (amber)—**Blue** (blue)—**Green** (green)—**Custom** (custom)

- If you select **Custom**, you can adjust the level of three primary colors such as red, green and blue. For details, *Adjusting the illumination color* on this page.

**3 Push MULTI-CONTROL up or down to adjust the brightness level.**

**+1 to -1** is displayed as the level is increased or decreased.

### Adjusting the illumination color

You can create an illumination color by adjusting the level of the three primary colors, which are red, green and blue.

- This function can be used only when **Custom** is selected in **Illumination 1**.

**1 Use MULTI-CONTROL to select Illumination 2 in the initial setting menu.**

Refer to *Adjusting initial settings* on page 35.

**2 Push MULTI-CONTROL left or right to select the color to adjust.**

**R** (red)—**G** (green)—**B** (blue)

**3 Push MULTI-CONTROL up or down to adjust the level of color.**

**4 to 0** is displayed as the level is increased or decreased.

### Setting the illumination interlock

This unit's button illumination can be interlocked with either the ignition key or the vehicle light switch. In this setting, you can select the appropriate option.

**1 Use MULTI-CONTROL to select ILL line in the initial setting menu.**

Refer to *Adjusting initial settings* on page 35.

**2 Press MULTI-CONTROL to turn this function on.**

When this function is on, the button illumination is interlocked with the vehicle light switch.

When this function is off, the button illumination is interlocked with the ignition switch.

- To turn off, press **MULTI-CONTROL** again.

## Correcting distorted sound

When listening to a CD or other source on which the recording level is high, setting the level of each frequency to high may result in distortion. You can switch the digital attenuator to low to reduce distortion.

- Sound quality is better at the high setting so this setting is usually used.

### 1 Use MULTI-CONTROL to select Digital ATT in the initial setting menu.

Refer to *Adjusting initial settings* on page 35.

### 2 Press MULTI-CONTROL to select the digital attenuator level.

Pressing **MULTI-CONTROL** repeatedly will switch between **High** (high) and **Low** (low) and that status will be displayed. 

## Resetting the audio functions

You can reset all audio functions.

### 1 Use MULTI-CONTROL to select Audio Reset in the initial setting menu.

Refer to *Adjusting initial settings* on page 35.

### 2 Press MULTI-CONTROL.

**Reset data?** appears in the display.

### 3 Push MULTI-CONTROL right.

**Are You Sure?** appears in the display.

### 4 Press MULTI-CONTROL to reset audio functions.

**Complete** appears in the display and audio functions are reset.

- To cancel this function on the way, press **B**. 

## Switching the sound muting/attenuation

Sound from this system is muted or attenuated automatically when the signal from the equipment with mute function is received.

- The sound is muted or attenuated, **MUTE** or **ATT** are displayed and no audio adjustment is possible.

- Sound from this system returns to normal when the muting or attenuation is canceled.

### 1 Use MULTI-CONTROL to select Mute in the initial setting menu.

Refer to *Adjusting initial settings* on page 35.

### 2 Press MULTI-CONTROL to switch the telephone muting/attenuation.

Each press of **MULTI-CONTROL** selects settings in the following order:

**20dB ATT** (20 dB attenuation)—**TEL mute** (mute)—**10dB ATT** (10 dB attenuation)

- **20dB ATT** has a stronger effect than **10dB ATT**. 

## Setting the polarity of the door operation

Before using door mute function, it is necessary to set the polarity of the door operation. Check the polarity of the door opening operation, and set it correctly.

### 1 Use MULTI-CONTROL to select Door mute 1 in the initial setting menu.

Refer to *Adjusting initial settings* on page 35.

### 2 Press MULTI-CONTROL to select setting.

Each press of **MULTI-CONTROL** selects settings in the following order:

**High** (high)—**Low** (low)

- If the polarity changes to + (positive) when the door is opened, select **High**.
- If the polarity changes to - (negative) when the door is opened, select **Low**. 

## Setting the door mute setting

Sound from this system is muted or attenuated automatically when the vehicle door is opened.

- Sound from this system returns to normal when the muting or attenuation is canceled.

## Initial Settings

**1 Use MULTI-CONTROL to select Door mute 2 in the initial setting menu.**  
Refer to *Adjusting initial settings* on page 35.

**2 Press MULTI-CONTROL to switch the door muting/attenuation.**  
Each press of **MULTI-CONTROL** selects settings in the following order:  
**OFF** (off)—**20dB ATT** (20 dB attenuation)—**MUTE** (mute) 

### Switching the reverse mode

If you do not perform an operation for about 30 seconds, screen indications start to reverse, and continue reversing every 10 seconds.

**1 Use MULTI-CONTROL to select Reverse mode in the initial setting menu.**  
Refer to *Adjusting initial settings* on page 35.

**2 Press MULTI-CONTROL to turn the reverse mode on.**

- To turn the reverse mode off, press **MULTI-CONTROL** again.
- You can also turn on or off reverse mode by pressing **B** while this unit is turned off. For more details, refer to *Reverse mode* on page 8. 

### Switching the ever scroll

When ever scroll is set to on, literal information such as CD title scrolls continuously in the display. Set to off if you prefer the information to scroll just once.

**1 Use MULTI-CONTROL to select Ever-scroll in the initial setting menu.**  
Refer to *Adjusting initial settings* on page 35.

**2 Press MULTI-CONTROL to turn the ever scroll on.**

- To turn the Ever Scroll off, press **MULTI-CONTROL** again. 

### Activating the BT Audio source

You need to activate the **BT Audio** source in order to use a Bluetooth audio player.

- You can only operate this function when Bluetooth adapter (e.g. CD-BTB200) is connected to this unit.

**1 Use MULTI-CONTROL to select BT AUDIO in the initial setting menu.**

Refer to *Adjusting initial settings* on page 35.

**2 Press MULTI-CONTROL to turn the BT Audio source on.**

- To turn the **BT Audio** source off, press **MULTI-CONTROL** again. 

### Entering PIN code for Bluetooth wireless connection

To connect your cellular phone to this unit via Bluetooth wireless technology, you need to enter PIN code on your phone to verify the connection. The default code is **0000**, but you can change this in this function.

- With some Bluetooth audio players, you may be required to enter the Bluetooth audio player PIN code in advance to set this unit for a connection.
- You can only operate this function when Bluetooth adapter (e.g. CD-BTB200) is connected to this unit.

**1 Use MULTI-CONTROL to select Pin code input in the initial setting menu.**

Refer to *Adjusting initial settings* on page 35.

**2 Push MULTI-CONTROL up or down to select a number.**

**3 Push MULTI-CONTROL left or right to move the cursor to the previous or next position.**

**4 After inputting PIN code (up to 16 digits), press MULTI-CONTROL.**

PIN code can be stored in memory.

When you press **MULTI-CONTROL** again on the same display, the PIN code you entered is stored in this unit.

- Pushing **MULTI-CONTROL** right in the confirmation display returns you to the PIN code input display, and you can change the PIN code. 

## Displaying system version for repair

Should this unit fails to operate properly and you consult your dealer for repair, you may be asked to indicate the system versions of this unit and of Bluetooth module. You can display the versions and confirm them.

- You can only operate this function when Bluetooth adapter (e.g. CD-BTB200) is connected to this unit.

### 1 Use **MULTI-CONTROL** to select **BT Version Info. in the initial setting menu.**

Refer to *Adjusting initial settings* on page 35. The system (microprocessor) version of this unit is displayed.

### 2 Push **MULTI-CONTROL** left to switch to the version of the Bluetooth module of this unit.

- Pushing **MULTI-CONTROL** right returns to the system version of this unit. 



## Other Functions

### Using the AUX source

Up to two auxiliary devices such as VCR or portable devices (sold separately) can be connected to this unit. When connected, auxiliary devices are automatically read as AUX sources and assigned to **AUX1** or **AUX2**. The relationship between **AUX1** and **AUX2** sources is explained below.

### About AUX1 and AUX2

There are two methods to connect auxiliary devices to this unit.

#### AUX1 source:

*When connecting auxiliary device using a stereo mini plug cable*

**1 Press and hold  $\blacktriangle$ /Open to open the front panel.**

AUX1 input jack appears.

**2 Insert the 2.5 mm stereo plug into the AUX1 input jack on this unit.**

This auxiliary device is automatically set to **AUX1**.

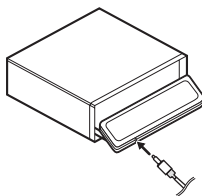

#### AUX2 source:

*When connecting auxiliary device using an IP-BUS-RCA Interconnector (sold separately)*

**● Use an IP-BUS-RCA Interconnector such as the CD-RB20/CD-RB10 (sold separately) to connect this unit to auxiliary device featuring RCA output.**

For more details, refer to the IP-BUS-RCA Interconnector owner's manual.

This auxiliary device is automatically set to **AUX2**.

■ You can only make this type of connection if the auxiliary device has RCA outputs.

### Selecting AUX as the source

**● Press SRC/Off to select AUX (AUX1 or AUX2) as the source.**

■ If the auxiliary setting is not turned on, **AUX** cannot be selected. For more details, refer to *Switching the auxiliary setting* on page 36.

### Setting the AUX title

The title displayed for the **AUX1** or **AUX2** source can be changed.

**1 After you have selected AUX as the source, use MULTI-CONTROL and select FUNCTION to display TitleInput "A".**

**2 Enter a title in the same way as the built-in CD player.**

For details concerning operation, refer to *Entering disc titles* on page 17.  $\square$

### Turning the clock display on or off

You can turn the clock display on or off.

• Even when the sources are off, the clock display appears on the display.

**● Press  $\odot$  to turn the clock display on or off.**

Each press of  $\odot$  turns the clock display on or off.

■ The clock display disappears temporarily when you perform other operations, but the clock display appears again after 4 seconds.  $\square$

## Using the external unit

External unit refers to a Pioneer product (such as ones available in the future) that, although incompatible as a source, enables control of basic functions with this unit. Two external units can be controlled with this unit. When two external units are connected, the external unit is automatically allocated to external unit 1 or external unit 2 by this unit.

Basic operations of the external unit are explained below. Allocated functions are different depending on the connected external unit. For details concerning functions, refer to external unit's owner's manual.

### Selecting the external unit as the source

- Press **SRC/Off** to select **EXTERNAL** as the source.

### Basic operation

Functions allocated to the following operations are different depending on the connected external unit. For details concerning functions, refer to the connected external unit's owner's manual.

- Press **B**.
- Press and hold **B**.
- Push **MULTI-CONTROL** left or right.
- Push and hold **MULTI-CONTROL** left or right.
- Push **MULTI-CONTROL** up or down.

### Advanced operations

- 1 Press **MULTI-CONTROL** to display the main menu.

#### 2 Use **MULTI-CONTROL** to select **FUNCTION**.

Turn to change the menu option. Press to select.

#### 3 Turn **MULTI-CONTROL** to select the function.

**Function1** (function 1)—**Function2** (function 2)—**Function3** (function 3)—**Function4** (function 4)—**Auto/Manual** (auto/manual)

- To return to the ordinary display, press **B**. 

## Using different entertainment displays

You can enjoy entertainment displays while listening to each sound source.

#### 1 Press **MULTI-CONTROL** to display the main menu.

**2 Use MULTI-CONTROL to select DISPLAY.**  
Turn to change the menu option. Press to select.

#### 3 Use **MULTI-CONTROL** to change the display.

Turn to change the menu option. Press to select.

**BASIC DISPLAY** (basic display)—

**SPECTRUM ANALYZER-1** (spectrum analyzer 1)—**SPECTRUM ANALYZER-2** (spectrum analyzer 2)—**LEVEL METER** (level meter)—

**DISPLAY OFF** (display off)

- To return to the playback display, press **B**.
- You can also select **DISPLAY OFF** (display off) by pressing and holding **EQ**.
- While the display indication is turned off, display off indicator lights up. 

## Using the **DF** (direct function) button

You can operate the preprogrammed functions for each source by using **DF** on the remote control.

## Other Functions

- **Press DF to turn pause on when selecting the following sources:**

- **CD** – Built-in CD player
- **iPod** – iPod connected using USB input/  
iPod connected with the interface adapter
- **Multi CD** – Multi-CD player
- **USB** – USB portable audio player/USB  
memory
- **BT Audio** – Bluetooth audio player
- **DVD** – DVD player/multi-DVD player
- To turn pause off, press **DF** again.

- **Press DF and hold to turn BSM on when selecting tuner as the source.**

Press **DF** and hold until the BSM turns on.

- To cancel the storage process, press **DF** again.

- **Press DF to turn function 1 on when selecting EXT (external unit 1/external unit 2) as the source.**

- To turn function 1 off, press **DF** again.

## XM tuner

### Listening to XM Satellite Radio

You can use this unit to control an XM satellite digital tuner (GEX-P920XM), which is sold separately.

For details concerning operation, refer to the XM tuner's operation manuals. This section provides information on XM operations with this unit which differs from that described in the XM tuner's operation manual.

- With this unit, you can operate two additional functions: XM channel direct selection and preset channel list.



- ① XM band indicator
- ② XM channel number indicator
- ③ XM preset number indicator
- ④ XM channel select setting indicator  
Shows what channel select setting has been selected. **CH** is displayed when **Channel number** is selected, and **CAT** is displayed when **Category** is selected.
- ⑤ Voltage indicator  
Shows the battery voltage.
  - The level displayed on the voltage indicator may differ from the actual voltage level.
- ⑥ XM text information  
Shows the text information of broadcast channel.

- **Select an XM band.**

Press **B**.

- Band can be selected from **XM1**, **XM2** or **XM3**.

- **Select a channel.**

Push **MULTI-CONTROL** left or right.

- If you push and hold **MULTI-CONTROL** left or right, you can increase or decrease channel number continuously.
- You can also perform tuning from a desired channel category. (Refer to *Selecting a channel in the channel category* on the next page.)

### Switching the XM display

- **Press D/Scr1 to switch the XM display.**
  - You can scroll the text information to the left by pressing and holding **D/Scr1**.

### Storing and recalling broadcast stations

You can easily store up to six broadcast stations for later recall.

- Six stations for each band can be stored in memory.

#### 1 Use MULTI-CONTROL to store the selected station in memory.

Turn to change the preset number. Press and hold to store.

The XM preset number you have selected will flash and then remain lit. The selected station has been stored in memory.

#### 2 Use MULTI-CONTROL to select the desired station.

Turn to change the station; press to select.

- You can also change the station by pushing **MULTI-CONTROL** up or down.
- If you do not operate the list within about 30 seconds, the display is automatically returned to the ordinary display.

### Selecting the XM channel select mode

You have two methods for selecting a channel: by number and by category. When selecting by number, channels in any category can be selected. Select by category to narrow your search down to only channels in a particular category.

## Available accessories

- Press **B** repeatedly to select the desired channel select setting.

**Channel number** (channel number select setting)—**Category** (channel category select setting)

- If you do not operate the function within about 30 seconds, the display is automatically returned to the channel display.

### Note

You can also perform this operation in the menu that appears by using **MULTI-CONTROL**.

## Selecting a channel in the channel category

- 1 Switch the channel select settings to **Category**.

Refer to *Selecting the XM channel select mode* on the previous page.

- 2 Push **MULTI-CONTROL** up or down to select the desired channel category.

- 3 Push **MULTI-CONTROL** left or right to select the desired channel in the selected channel category.

## Displaying the Radio ID

### Channel number select setting

- 1 Select the channel select settings to **Channel number**.

Refer to *Selecting the XM channel select mode* on the previous page.

- 2 Push **MULTI-CONTROL** left or right to select **RADIO ID**.

- If you select another channel, display of the ID code is canceled.
- Display of the ID code repeats displaying **RADIO ID** and the ID code one after the other. 

## SIRIUS Satellite Radio tuner

### Listening to SIRIUS Satellite Radio

You can use this unit to control a SIRIUS Satellite Radio tuner, which is sold separately.

When the SIRIUS tuner is used together with this unit, some operations differ slightly from those described in the SIRIUS operation manual. This manual provides information on these points. For all other information on using the SIRIUS tuner, please refer to the SIRIUS operation manual.

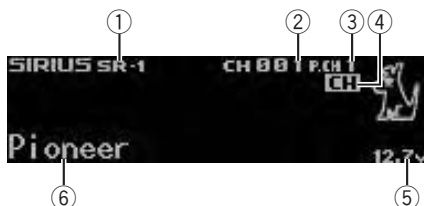

- ① SIRIUS band indicator
- ② SIRIUS channel number indicator
- ③ SIRIUS preset number indicator
- ④ SIRIUS channel select setting indicator  
Shows what channel select setting has been selected. **CH** is displayed when **Channel number** is selected, and **CAT** is displayed when **Category** is selected. **I.R** is displayed during the Instant Replay mode.
- ⑤ Voltage indicator  
Shows the battery voltage.
  - The level displayed on the voltage indicator may differ from the actual voltage level.
- ⑥ SIRIUS channel name  
Shows the channel name of broadcast channel.

- **Select a SIRIUS band.**

Press **B**.

- Band can be selected from **SR1**, **SR2** or **SR3**.

- **Select a channel.**

Push **MULTI-CONTROL** left or right.

- If you push and hold **MULTI-CONTROL** left or right, you can increase or decrease channel number continuously.
- You can also perform tuning from a desired channel category. (Refer to *Selecting a channel in the channel category* on the next page.)

**Note**

It may take a few seconds before you can hear anything while this unit acquires and processes the satellite signal when you change the source to SIRIUS tuner or select a channel.

**Switching the SIRIUS display**

- **Press D/Scrl to switch the SIRIUS display.**

Each press of **D/Scrl** changes the SIRIUS display in the following order:

Play time—Channel number—Channel name—Category name—Artist name—Song title/program title—Composer name

- Play time is displayed during the Instant Replay mode. Refer to *Using Instant Replay function* on page 48.
- Play time display indicates the time inverted from the live broadcast. Play time is displayed in negative number.

**Storing and recalling broadcast stations**

You can easily store up to six broadcast stations for later recall.

- Six stations for each band can be stored in memory.

- 1 Use MULTI-CONTROL to store the selected station in memory.**

Turn to change the preset number. Press and hold to store.

The SIRIUS preset number you have selected will flash and then remain lit. The selected station has been stored in memory.

- 2 Use MULTI-CONTROL to select the desired station.**

Turn to change the station; press to select.

- You can also change the station by pushing **MULTI-CONTROL** up or down.
- If you do not operate the list within about 30 seconds, the display is automatically returned to the ordinary display.

**Introduction of advanced operations**

- 1 Press MULTI-CONTROL to display the main menu.**

- 2 Use MULTI-CONTROL to select FUNCTION.**

The function selection menu is displayed. Turn to change the menu option. Press to select.

- 3 Turn MULTI-CONTROL to select the function.**

**Channel mode** (channel select mode setting)—**Game alert** (game alert setting)—**Team setting** (team setting)—**Game info** (game info)—**Pause** (pause)

**Notes**

- To return to the ordinary display, press **B**.
- If you do not operate functions within about 30 seconds, the display is automatically returned to the ordinary display.
- During the Instant Replay mode, you can select **Pause** (pause). Refer to *Using Instant Replay function* on page 48.
- **Pause** is the same as that of the built-in CD player. (Refer to *Pausing playback* on page 17.)

## Available accessories

### Selecting the SIRIUS channel select mode

You have two methods for selecting a channel: by number and by category. When selecting by number, channels in any category can be selected. Select by category to narrow your search down to only channels in a particular category.

- **Press B repeatedly to select the desired channel select setting.**

**Channel number** (channel number select setting)—**Category** (channel category select setting)



#### Note

You can also perform this operation in the menu that appears by using **MULTI-CONTROL**.

### Selecting a channel in the channel category

- 1 Select the channel select settings to Category.**

Refer to *Selecting the SIRIUS channel select mode* on this page.

- 2 Push MULTI-CONTROL up or down to select the desired channel category.**

- 3 Push MULTI-CONTROL left or right to select the desired channel in the selected channel category.**

### Using the Game Alert function

This system can alert you when games involving your favorite teams are about to start. To use this function you need in advance to set up a game alert for the teams.

- To use this function, Pioneer SIRIUS bus interface (e.g. CD-SB10) is required.
- To use this function, SIRIUS plug-and-play unit with Game Alert Function is required.
- For details, refer to SIRIUS plug-and-play unit's manuals.

- You can also operate this function when SIR-PNR2 is connected to this unit.

### Selecting teams for Game Alert

- 1 Display the function selection menu.**

Refer to *Introduction of advanced operations* on the previous page.

- 2 Use MULTI-CONTROL to select Team setting in the function menu.**

- 3 Push MULTI-CONTROL left or right to select a desired league.**

League names are switched in the display.

- 4 Push MULTI-CONTROL up or down to select a desired team.**

Teams in the selected category are switched in the display.

- 5 Press MULTI-CONTROL to store the selected team in memory.**

The game alert function will start on that team.

- To turn the Game Alert off of the selected team, press **MULTI-CONTROL** again.
- When you have already made 12 team selections, **FULL** is displayed and additional team selection is not possible. In this case, first delete the team selection and then try again.

- 6 Repeat these steps for selecting other teams.**

Up to 12 teams can be selected.

### Switching the Game Alert on or off

Once you made team selections, you need to turn the Game Alert function on.

- The Game Alert function is on at the default setting.

- 1 Display the function selection menu.**

Refer to *Introduction of advanced operations* on the previous page.

- 2 Use MULTI-CONTROL to select Game alert in the function menu.**

### 3 Press **MULTI-CONTROL** to turn the **Game Alert** on.

The Game Alert function is now on.

- To turn the Game Alert function off, press **MULTI-CONTROL** again.

### When the game of the selected team starts

When a game of the selected team is about to start (or is currently playing) on a different station, **Game alert** is displayed. Press and hold **MULTI-CONTROL** to switch to that station, and you can listen to that game.

- If you do not operate the function within about 10 seconds, the display is automatically returned.

### Displaying game information

If games of your selected teams are currently playing, you can display information of the games and tune to the broadcast channel. You can display information of the games while enjoying the sound from currently tuning station. You can also tune to the broadcast channel when you wish to.

#### 1 Display the function selection menu.

Refer to *Introduction of advanced operations* on page 46.

#### 2 Use **MULTI-CONTROL** to select **Game info** in the function menu.

The game information of your selected team is displayed.

#### 3 Push **MULTI-CONTROL** up or down to select a game.

The game is displayed, followed by more detailed game information.

- Game score will be updated automatically.

#### 4 Press **MULTI-CONTROL** to switch to that station to listen to the game.

### Notes

- If you have not made any team selections, **NOT SET** is displayed.
- When games involving your favorite teams are not currently playing, **NO GAME** is displayed.

### Displaying the Radio ID

If you select **RADIO ID**, the ID code is displayed.

- Push **MULTI-CONTROL** left or right to select **RADIO ID**.

### Note

To select **RADIO ID**, set the channel select setting to **Channel number**. About the channel select setting, refer to *Selecting the SIRIUS channel select mode* on the previous page.

### Using Instant Replay function

Following functions can be operated during the Instant Replay mode.

- To use this function, Pioneer SIRIUS bus interface (e.g. CD-SB10) is required.
- To use this function, SIRIUS plug-and-play unit with Instant Replay Function is required.
- For details, refer to SIRIUS plug-and-play unit's manuals.

#### ● Performing the Instant Replay mode

When SIRIUS tuner is selected as the source, press and hold **B**.

- In the following conditions, tuner exits from the Instant Replay mode.
  - When **B** is pressed
  - When another source is selected

#### ● Select a track

Push **MULTI-CONTROL** left or right.

#### ● Fast forward or reverse

Push and hold **MULTI-CONTROL** left or right for about one second and release. 



## Available accessories

### HD Radio™ tuner

#### Basic Operations

You can use this unit to control an HD Radio tuner (e.g. GEX-P20HD), which is sold separately.

For details concerning operation, refer to the HD Radio tuner's operation manual.

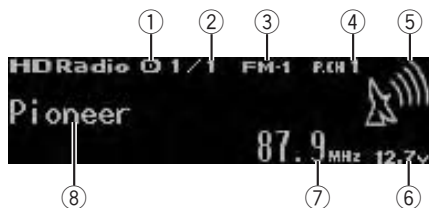

- ① (signal reception status) indicator  
When digital signal is received, is displayed. Otherwise, is displayed.
- ② Channel number
- ③ Band indicator
- ④ Preset number indicator
- ⑤ Signal level indicator  
Shows the radio wave strength.
- ⑥ Voltage indicator  
Shows the battery voltage.
  - The level displayed on the voltage indicator may differ from the actual voltage level.
- ⑦ Frequency indicator
- ⑧ Title name

#### ● Select a band

Press **B**.

- Band can be selected from among **FM1**, **FM2**, **FM3** or **AM**.

#### ● Manual tuning (step by step)

Push **MULTI-CONTROL** left or right.

#### ● Seek tuning

Push and hold **MULTI-CONTROL** left or right, and then release.

- You can cancel seek tuning by pushing **MULTI-CONTROL** left or right.

### Storing and recalling broadcast frequencies

The operation is the same as that of the tuner. (Refer to *Storing and recalling broadcast frequencies* on page 13.)

### Switching the display

Desired information can be displayed.

#### ● Press **D/Scrl**.

Press **D/Scrl** repeatedly to switch between the following settings:

Station name—artist name—song title—program type

- When the tuner has been tuned in to an HD Radio broadcasting, default display is changed into station name instead of frequency.

### Introduction to advanced operations

#### 1 Press **MULTI-CONTROL** to display the main menu.

#### 2 Use **MULTI-CONTROL** to select **FUNCTION**.

Turn to change the menu option. Press to select.

The function menu is displayed.

#### 3 Turn **MULTI-CONTROL** to select the function.

**BSM** (best stations memory)—**Local** (local seek tuning)—**Seek mode** (seek mode)—**Blending** (reception mode)

### Function and operation

**BSM** and **Local** operations are basically the same as that of the tuner.

Function name	Operation
<b>BSM</b>	Refer to <i>Storing the strongest broadcast frequencies</i> on page 14.
<b>Local</b>	Refer to <i>Tuning in strong signals</i> on page 14.

### Note

To return to the playback display, press **B**.

## Switching the seek mode

There are two method of seek tuning settings, one is **Seek HD** (Digital broadcasting stations seek) and the other is **Seek ALL** (normal seek).

### 1 Use MULTI-CONTROL to select Seek mode in the function menu.

Refer to *Introduction to advanced operations* on the previous page.

### 2 Press MULTI-CONTROL to select your favorite setting. Seek ALL—Seek HD

## Switching the reception mode

If a digital broadcast reception condition gets poor, this unit automatically switches to the analog broadcast of the same frequency level. If this function is set to on, the tuner switches between digital broadcast and analog broadcast automatically. If this function is off, reception will be conducted within an analog broadcast.

### 1 Use MULTI-CONTROL to select Blending in the function menu.

Refer to *Introduction to advanced operations* on the previous page.

### 2 Press MULTI-CONTROL to select your favorite setting. ON—OFF

## Playing songs on iPod

### Basic operation

You can use this unit to control an interface adapter for iPod (e.g. CD-IB100II), which is sold separately.



- ① Song number indicator
- ② Voltage indicator  
Shows the battery voltage.
  - The level displayed on the voltage indicator may differ from the actual voltage level.
- ③ Play time indicator
- ④ Song time (progress bar)

### ● Fast forward or reverse

Push and hold **MULTI-CONTROL** left or right.

### ● Select a track

Push **MULTI-CONTROL** left or right.

### Note

- Read the precautions for iPod in the following section. Refer to page 72.
- If an error message is displayed, refer to *Error messages* on page 68.
- When the ignition switch is set to ACC or ON, the iPod's battery is charged while the iPod is connected to this unit.
- While the iPod is connected to this unit, the iPod cannot be turned on or off.
- Before connecting the iPod to this unit, disconnect the headphones from the iPod.
- The iPod is turned off about two minutes after the ignition switch is set to OFF.

## Available accessories

### Displaying text information on iPod

#### ● Press D/Scrl to select the desired text information.

Play time—: artist name and : song title  
—: artist name and : album name—:  
album name and : song title—: song title  
and play time

- If the characters recorded on the iPod are not compatible with this unit, those characters are not displayed.



#### Notes

- You can scroll through text data by pressing and holding **D/Scrl**.
- When Ever Scroll is set to ON at the initial setting, text information scrolls continuously in the display. Refer to *Switching the ever scroll* on page 39.

### Browsing for a song

The operation is the same as that of the iPod connected to USB interface of this unit. (Refer to *Browsing for a song* on page 20.)

However, the selectable categories are slightly different. Selectable categories are **Playlists** (playlists)—**Artists** (artists)—**Albums** (albums)—**Songs** (songs)—**Genres** (genres)

- You cannot search songs by alphabet in the list while using an iPod with interface adapter.

### Introduction to advanced operations

#### 1 Press MULTI-CONTROL to display the main menu.

#### 2 Use MULTI-CONTROL to select FUNCTION.

Turn to change the menu option. Press to select.

#### 3 Turn MULTI-CONTROL to select the function.

**Play mode** (repeat play)—**Shuffle mode** (shuffle)—**Pause** (pause)

### Function and operation

**Play mode** and **Pause** operations are basically the same as that of the built-in CD player.

Also, **Shuffle mode** operation is basically the same as that of iPod connected to USB interface of this unit.

Function name	Operation
<b>Play mode</b>	Refer to <i>Selecting a repeat play range</i> on page 16. However, the repeat play ranges you can select are different from that of the built-in CD player. The repeat play ranges of the iPod are: <ul style="list-style-type: none"> <li>• <b>Repeat One</b> – Repeat the current song</li> <li>• <b>Repeat All</b> – Repeat all songs in the selected list</li> </ul>
<b>Shuffle mode</b>	Refer to <i>Playing songs in a random order (shuffle)</i> on page 22.
<b>Pause</b>	Refer to <i>Pausing playback</i> on page 17.



#### Notes

- To return to the ordinary display, press **B**.
- If you do not operate functions within about 30 seconds, the display automatically returns to the ordinary display.

### Bluetooth Audio

If you connect a Bluetooth adapter (e.g. CD-BTB200) to this unit, you can control Bluetooth audio players via Bluetooth wireless technology.

- In some countries, CD-BTB200 is not sold on the market.

## Basic Operations

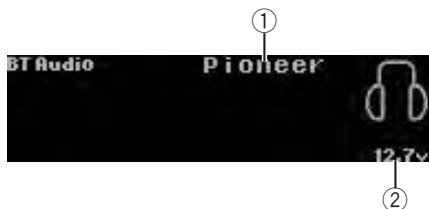

- ① Device name  
Shows the device name of the connected Bluetooth audio player (or Bluetooth adapter).
- ② Voltage indicator  
Shows the battery voltage.
  - The level displayed on the voltage indicator may differ from the actual voltage level.

### Important

- Depending on the Bluetooth audio player connected to this unit, the operations available with this unit are limited to the following two levels:
  - A2DP profile (Advanced Audio Distribution Profile): Only playing back songs on your audio player is possible.
  - AVRCP profile (Audio/Video Remote Control Profile): Playing back, pausing, selecting songs, etc., are possible.
- Since there are a number of Bluetooth audio players available on the market, operations with your Bluetooth audio player using this unit vary extensively. Refer to the instruction manual that came with your Bluetooth audio player as well as this manual while operating your player on this unit.
- Information about songs (e.g. the elapsed playing time, song title, song index, etc.) cannot be displayed on this unit.
- While you are listening to songs on your Bluetooth audio player, refrain from using your cellular phone as much as possible. If you use your cellular phone, the signal from your cellular phone may cause noise on the song playback.

- When you are talking on a cellular phone connected to this unit via Bluetooth wireless technology, song playback from your Bluetooth audio player connected to this unit is muted.
- Even if you are listening to a song on your Bluetooth audio player and you switch to another source, song playback continues.

### ● Fast forward or reverse

Push and hold **MULTI-CONTROL** left or right.

### ● Select a track

Push **MULTI-CONTROL** left or right.

### Notes

- For details concerning operation, refer to the Bluetooth adapter's operation manual. This section provides brief information on Bluetooth audio player operations with this unit, which slightly differs or is abbreviated from that described in the Bluetooth adapter's operation manual.
- Even though your audio player does not contain a Bluetooth module, you can still control it from this unit via Bluetooth wireless technology. To control your audio player using this unit, connect a product featuring Bluetooth wireless technology (available on the market) to your audio player and connect the Bluetooth adapter (e.g. CD-BTB200) to this unit.

## Function and operation

**1 Press MULTI-CONTROL to display the main menu.**

**2 Use MULTI-CONTROL to select FUNCTION.**

Turn to change the menu option. Press to select.

**3 Turn MULTI-CONTROL to select the function.**

**Connection open** (connection open)—**Disconnect audio** (disconnect audio)—**Play** (play)—**Stop** (stop)—**Pause** (pause)—**Device info.** (device information)

## Available accessories

- **Pause** is the same as that of the built-in CD player. (Refer to *Pausing playback* on page 17.)

### Notes

- To return to the ordinary display, press **B**.
- If a Bluetooth audio player is not connected to this unit yet, **Connection open** and **Device info.** appear in the function menu and other functions are not available.
- If a Bluetooth audio player is connected via AVRCP (Audio/Video Remote Control Profile), **Connection open** does not appear in the function menu.
- If a Bluetooth audio player is connected via A2DP (Advanced Audio Distribution Profile), only **Disconnect audio** and **Device info.** appear in the function menu.
- If you do not operate functions other than **Connection open** and **Disconnect audio** within about 30 seconds, the display is automatically returned to the ordinary display.

## Connecting a Bluetooth audio player

**1 Use MULTI-CONTROL to select Connection open in the function menu.**  
Refer to *Function and operation* on the previous page.

**2 Press MULTI-CONTROL to open the connection.**

**Always waiting** is displayed. This unit is now on standby for connection from Bluetooth audio player.

If your Bluetooth audio player is set ready for Bluetooth wireless connection, connection to this unit is automatically established.

### Note

Before you can use audio players you may need to enter the PIN code into this unit. If your player requires a PIN code to establish a connection, look for the code on the player or in its accompanying documentation. Refer to *Entering PIN code for Bluetooth wireless connection* on page 39.

## Playing songs on a Bluetooth audio player

**1 Use MULTI-CONTROL to select Play in the function menu.**

Refer to *Function and operation* on the previous page.

**2 Press MULTI-CONTROL to start playback.**

## Stopping playback

**1 Use MULTI-CONTROL to select Stop in the function menu.**

Refer to *Function and operation* on the previous page.

**2 Press MULTI-CONTROL to stop the playback.**

## Disconnecting a Bluetooth audio player

**1 Use MULTI-CONTROL to select Disconnect audio in the function menu.**

Refer to *Function and operation* on the previous page.

**2 Press MULTI-CONTROL to disconnect the Bluetooth audio player.**

**Disconnected** is displayed. The Bluetooth audio player is now disconnected from this unit.

## Displaying BD (Bluetooth Device) address

**1 Use MULTI-CONTROL to select Device info. in the function menu.**

Refer to *Function and operation* on the previous page.

**2 Push MULTI-CONTROL left to switch to the BD address.**

12-digit hexadecimal string is displayed.

- Pushing **MULTI-CONTROL** right returns to the device name. 

## Bluetooth Telephone

If you use a Bluetooth adapter (e.g. CD-BTB200), you can connect a cellular phone featuring Bluetooth wireless technology to this unit for hands-free, wireless calls, even while driving.

- In some countries, CD-BTB200 is not sold on the market.

## Basic Operations

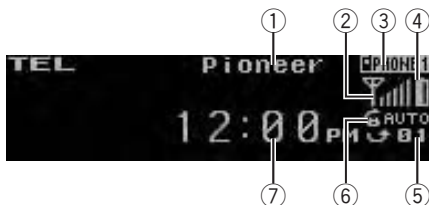

- Device name  
Shows the device name of the cellular phone.
- Signal level indicator  
Shows the signal strength of cellular phone.
  - The level shown on the indicator may differ from the actual signal level.
- User number indicator  
Shows the registration number of the cellular phone.
- Battery strength indicator  
Shows the battery strength of cellular phone.
  - The level shown on the indicator may differ from the actual battery strength.
  - If the battery strength is not available, nothing is displayed in the battery strength indicator area.
- Incoming call notice indication  
Shows when an incoming call has been received and not checked yet.
  - Incoming call notice is not displayed for calls made when your cellular phone is disconnected from this unit.

- Automatic answering/Automatic rejecting indicator  
Shows **AUTO** when the automatic answering function is on (for more details, refer to *Setting automatic answering* on page 62).  
Shows **REFUSE** when the automatic rejecting function is on (for more details, refer to *Setting automatic rejecting* on page 62).
- Clock display  
Shows the time (if connected with a phone).



### Important

- Since this unit is on standby to connect with your cellular phone via Bluetooth wireless technology, using this unit without running the engine can result in battery drainage.
- Advanced operations that require your attention such as dialing numbers on the monitor, using phone book, etc., are prohibited while you are driving. When you need to use these advanced operations, stop your vehicle in a safe place.



### Notes

- The equalizer curve for the phone source is fixed.
- When selecting the phone source, you can only operate **Fader** (balance adjustment) in the audio menu.

## Setting up for hands-free phoning

Before you can use the hands-free phoning function you must set up the unit for use with your cellular phone. This entails establishing a Bluetooth wireless connection between this unit and your phone, registering your phone with this unit, and adjusting the volume level.

### 1 Connection

For detailed instructions on connecting your phone to this unit via Bluetooth wireless technology, refer to *Connecting a cellular phone* on page 56.

## Available accessories

- Your phone should now be temporarily connected. However, to make best use of the technology, we recommend you register the phone to this unit.

### 2 Registration

To register your temporarily connected phone, refer to *Registering a connected cellular phone* on page 57.

### 3 Volume adjustment

Adjust the earpiece volume on your cellular phone for comfort. When adjusted, the volume level is recorded in this unit as the default setting.

- Caller's voice volume and ring volume may vary depending on the type of cellular phone.
- If the difference between the ring volume and caller's voice volume is big, overall volume level may become unstable.
- Before disconnecting the cellular phone from this unit, make sure to adjust the volume to a proper level. If the volume is muted (zero level) on your cellular phone, the volume level of your cellular phone remains muted even after the cellular phone is disconnected.

## Making a phone call

### Voice recognition

#### 1 Press B and hold until Voice dial appears in the display.

**Voice dial** appears in the display. When **Voice dial ON** is displayed, voice recognition function is now ready.

- If your cellular phone does not feature voice recognition function, **No voice dial** appears in the display and operation is not possible.

#### 2 Pronounce the name of your contact.

## Taking a phone call

### Answering or rejecting an incoming call

#### ● Answering an incoming call

When a call comes in, press

**MULTI-CONTROL**.

- You can also perform this operation by pushing **MULTI-CONTROL** up.

#### ● End a call

Push **MULTI-CONTROL** down.

#### ● Rejecting an incoming call

When a call comes in, push **MULTI-CONTROL** down.



#### Notes

- If private mode is selected on the cellular phone, hands-free phoning may not be performed.
- The estimated call time appears in the display (this may differ slightly from the actual call time).

## Operating a call waiting

#### ● Answering a call waiting

When a call comes in, press

**MULTI-CONTROL**.

- You can also perform this operation by pushing **MULTI-CONTROL** up.

#### ● End all calls

Push **MULTI-CONTROL** down.

#### ● Switch between callers on hold

Press **MULTI-CONTROL**.

- You can also perform this operation by pushing **MULTI-CONTROL** up.

#### ● Rejecting call waiting

Push **MULTI-CONTROL** down.



#### Notes

- Pushing **MULTI-CONTROL** down ends all calls including calls waiting on line.

- To end the call, both you and your caller need to hang up the phone.

## Function and operation

**1 Press MULTI-CONTROL to display the main menu.**

**2 Use MULTI-CONTROL to select FUNCTION.**

Turn to change the menu option. Press to select.

**3 Turn MULTI-CONTROL to select the function.**

**Search&Connect** (search and connect)—

**Disconnect phone** (disconnect phone)—

**Connection open** (connection open)—

**Set phone** (registering phone)—

**Connect phone** (connect phone)—

**Delete phone** (delete phone)—**PH.B.Transfer**

(phone book transfer)—**PH.B.Name view**

(phone book name view)—**Clear memory**

(clear memory)—**Number dial** (call by enter-

ing number)—**Refuse calls** (automatic reject

setting)—**Auto answer** (automatic answer

setting)—**Ring tone** (ring tone select)—

**Auto connect** (automatic connection setting)

—**Echo cancel** (echo cancel)—**Device info.**

(device information)

### **If not connected yet**

The following functions cannot be operated.

- **Disconnect phone** (disconnect phone)
- **Set phone** (registering phone)
- **PH.B.Name view** (phone book name view)
- **Clear memory** (clear memory)
- **Number dial** (call by entering number)

### **If connected but not registered yet**

The following functions cannot be operated.

- **Search&Connect** (search and connect)
- **Connection open** (connection open)
- **Connect phone** (connect phone)
- **PH.B.Name view** (phone book name view)
- **Clear memory** (clear memory)

### **If already connected and registered**

The following functions cannot be operated.

- **Search&Connect** (search and connect)

- **Connection open** (connection open)
- **Set phone** (registering phone)
- **Connect phone** (connect phone)



### Notes

- To return to the playback display, press **B**.
- **Device info.** is the same as that of the Bluetooth audio. (Refer to *Displaying BD (Bluetooth Device) address* on page 53.)
- **PH.B.Name view** (phone book name view) cannot be selected for cellular phone registered guest phone.
- If cellular phone is connected to this unit via Bluetooth wireless technology with HSP (Head Set Profile), **PH.B.Name view**, **Clear memory**, **Number dial** and **Refuse calls** cannot be selected.
- If you do not operate functions other than **Search&Connect**, **Connection open**, **Connect phone**, **PH.B.Transfer**, **Disconnect phone**, **Number dial** and **Clear memory** within about 30 seconds, the display automatically returns to the ordinary display.

## Connecting a cellular phone

### Searching for available cellular phones

**1 Use MULTI-CONTROL to select Search&Connect in the function menu.**

Refer to *Function and operation* on this page.

**2 Press MULTI-CONTROL to search for available cellular phones.**

While searching, **Searching** flashes. When available cellular phones featuring Bluetooth wireless technology are found, device name or **Name not found** (if names cannot be obtained) is displayed.

- If this unit fails to find any available cellular phones, **Not found** is displayed.

**3 Push MULTI-CONTROL up or down to select a device name you want to connect.**

- Push **MULTI-CONTROL** left or right to switch the BD address and device name.



## Available accessories

### 4 Press MULTI-CONTROL to connect the selected cellular phone.

While connecting, **Connecting** flashes. To complete the connection, check the device name (**Pioneer BT Unit**) and enter the link code on your cellular phone. If the connection is established, **Connected** is displayed.

- PIN code is set to **0000** as the default. You can change this code. Refer to *Entering PIN code for Bluetooth wireless connection* on page 39.

### Using a cellular phone to initiate a connection

#### 1 Use MULTI-CONTROL to select Connection open in the function menu.

Refer to *Function and operation* on the previous page.

#### 2 Press MULTI-CONTROL to open the connection.

**Always waiting** flashes and the unit is now on standby for connection from a cellular phone.

#### 3 Use cellular phone to connect to this unit.

- PIN code is set to **0000** as the default. You can change this code. Refer to *Entering PIN code for Bluetooth wireless connection* on page 39.

### Disconnecting a cellular phone

#### 1 Use MULTI-CONTROL to select Disconnect phone in the function menu.

Refer to *Function and operation* on the previous page.

Device name of the connected phone appears in the display.

#### 2 Press MULTI-CONTROL to disconnect a cellular phone from this unit.

After disconnection is completed, **Disconnected** is displayed.

### Registering a connected cellular phone

#### 1 Use MULTI-CONTROL to select Set phone in the function menu.

Refer to *Function and operation* on the previous page.

#### 2 Push MULTI-CONTROL up or down to select a pairing assignment.

**P1** (user phone 1)—**P2** (user phone 2)—**P3** (user phone 3)—**G1** (guest phone 1)—**G2** (guest phone 2)

- Push **MULTI-CONTROL** left or right to switch the BD address and device name.

- As you select each assignment, you can see whether or not a phone is already registered. If the assignment is empty, **No data** is displayed. If the assignment is already taken, the device name appears. To replace an assignment with a new phone, first delete the current assignment. For more detailed instructions, see *Deleting a registered phone* on this page.

#### 3 Press MULTI-CONTROL to register the currently connected phone.

When registration is completed,

**Reg.Completed** is displayed.

- If the registration fails, **Reg.ERROR** is displayed. In this case, return to step 1 and try again.

### Deleting a registered phone

#### 1 Use MULTI-CONTROL to select Delete phone in the function menu.

Refer to *Function and operation* on the previous page.

#### 2 Push MULTI-CONTROL up or down to select a pairing assignment.

**P1** (user phone 1)—**P2** (user phone 2)—**P3** (user phone 3)—**G1** (guest phone 1)—**G2** (guest phone 2)

- Push **MULTI-CONTROL** left or right to switch the BD address and device name.

- If the assignment is empty, **No data** is displayed and operation is not possible.

### 3 Push MULTI-CONTROL right to select Delete YES.

Delete YES is displayed. Deleting phone is now on standby.

### 4 Press MULTI-CONTROL to delete the phone.

After the phone is deleted, Deleted is displayed.

## Connecting to a registered cellular phone

### Connecting to a registered phone manually

#### 1 Use MULTI-CONTROL to select Connect phone in the function menu.

Refer to *Function and operation* on page 56.

#### 2 Push MULTI-CONTROL up or down to select a pairing assignment.

P1 (user phone 1)—P2 (user phone 2)—P3 (user phone 3)—G1 (guest phone 1)—G2 (guest phone 2)

- Push MULTI-CONTROL left or right to switch the BD address and device name.
- If the assignment is empty, No data is displayed and operation is not possible.

#### 3 Press MULTI-CONTROL to connect the selected cellular phone.

While connecting, Connecting is displayed. After the connection is completed, Connected is displayed.

### Connecting to a registered phone automatically

#### 1 Use MULTI-CONTROL to select Auto connect in the function menu.

Refer to *Function and operation* on page 56.

#### 2 Press MULTI-CONTROL to turn automatic connection on.

If your cellular phone is ready for Bluetooth wireless connection, connection to this unit is automatically established.

- To turn automatic connection off, press MULTI-CONTROL again.

## Using the phone book

### Transferring entries to the phone book

The Phone Book can hold a total of 500 entries. 300 from User 1, 150 from User 2, and 50 from User 3.

#### 1 Use MULTI-CONTROL to select PH.B.Transfer in the function menu.

Refer to *Function and operation* on page 56.

#### 2 Press MULTI-CONTROL to enter the phone book transfer standby mode.

Transfer YES appears in the display.

#### 3 Press MULTI-CONTROL to show the confirmation display.

Transfer -/- appears in the display.

#### 4 Use the cellular phone to perform phone book transfer.

Perform phone book transfer using the cellular phone. For detailed instructions, refer to the instruction manual that came with your cellular phone.

- The display indicates how many entries have been transferred and the total number to be transferred.

#### 5 Data transferred is displayed and phone book transfer is completed.

## Changing the phone book display order

#### 1 Use MULTI-CONTROL to select PH.B.Name view in the function menu.

Refer to *Function and operation* on page 56.

Invert names YES appears in the display.

#### 2 Press MULTI-CONTROL to change the name view order.

Inverted is displayed and the name view order is changed.

## Available accessories

Pressing **MULTI-CONTROL** repeatedly changes the name view order between first and last name.

### Calling a number in the phone book

#### Important

Be sure to park your vehicle and apply the parking brake when performing this operation.

After finding the number you want to call in the phone book, you can select the entry and make the call.

#### 1 Turn **MULTI-CONTROL** to display the list.

#### 2 Press **D/Scrl** to display the phone book.

Press **D/Scrl** repeatedly to switch between the following lists:

Phone book—Missed call—Dialled call—Received call

#### 3 Push **MULTI-CONTROL** left or right to select the first letter of the name you are looking for.

#### 4 Press **MULTI-CONTROL** to display entries.

The display shows the first three Phone Book entries starting with that letter (e.g. “Ben”, “Brian” and “Burt” when “B” is selected).

#### 5 Push **MULTI-CONTROL** up or down to select a Phone Book entry you want to call.

- You can scroll through text data by pressing and holding **D/Scrl**.

#### 6 Push **MULTI-CONTROL** right to display the detailed list of the selected entry.

The phone number, name and genre (if assigned) of entries are displayed in the detailed list.

- You can scroll through text data by pressing and holding **D/Scrl**.

- If several phone numbers are included in an entry, select one by turning **MULTI-CONTROL**.

- If you want to go back and select another entry, push **MULTI-CONTROL** left.

#### 7 Press **MULTI-CONTROL** to make a call.

#### 8 To end the call, push **MULTI-CONTROL** down.

### Editing the name of a Phone Book entry

#### Important

Be sure to park your vehicle and apply the parking brake when performing this operation.

You can edit the names of Phone Book entries. Each name can be up to 16 characters long.

#### 1 Display the detailed list of your desired Phone Book entry.

Please see Steps 1 to 6 of the following section for how to do this. Refer to *Calling a number in the phone book* on this page.

#### 2 Press and hold **MULTI-CONTROL** to display the name input screen.

**Edit name** is displayed.

#### 3 Press **D/Scrl** to select the desired character type.

Each press of **D/Scrl** switches the character types in the following order:

Alphabet (upper case), numbers and symbols—alphabet (lower case)—numbers and symbols—European characters, such as those with accents (e.g., **á**, **à**, **ä**, **ç**) or Russian characters

- Pressing and holding **D/Scrl** enables you to switch character set between ISO8859-1 (European characters) and ISO8859-5 (Russian characters) alternately.

- European characters and Russian characters can't be mixed.

#### 4 Push **MULTI-CONTROL** up or down to select a letter.

- To delete a character and leave a space, select “\_” (underscore).

**5 Push MULTI-CONTROL left or right to move the cursor to the previous or next character position.**

**6 Press MULTI-CONTROL to store the new name.**

### Editing phone numbers



#### Important

Be sure to park your vehicle and apply the parking brake when performing this operation.

You can edit the numbers of Phone Book entries. Each phone number can be up to 24 digits long.

#### 1 Display the detailed list of your desired Phone Book entry.

Please see Steps 1 to 6 of the following section for how to do this. Refer to *Calling a number in the phone book* on the previous page.

#### 2 Press and hold MULTI-CONTROL to display the name input screen.

**Edit name** is displayed.

#### 3 Turn MULTI-CONTROL to switch to the number input screen.

**Edit name** (name input screen)—

**Edit number** (number input screen)—

**Clear memory** (clear memory screen)

#### 4 Push MULTI-CONTROL left or right to move the cursor to the number you want to change.

#### 5 Push MULTI-CONTROL up or down to change numbers.

Repeat these steps until you have finished changing.

#### 6 Press MULTI-CONTROL to store the new number.

### Clearing a phone book entry



#### Important

Be sure to park your vehicle and apply the parking brake when performing this operation.

#### 1 Display the detailed list of your desired Phone Book entry.

Please see Steps 1 to 5 of the following section for how to do this. Refer to *Calling a number in the phone book* on the previous page.

#### 2 Press and hold MULTI-CONTROL to display the name input screen.

**Edit name** is displayed.

#### 3 Turn MULTI-CONTROL to switch to the clear memory screen.

**Edit name** (name input screen)—

**Edit number** (number input screen)—

**Clear memory** (clear memory screen)

#### 4 Push MULTI-CONTROL right to show a confirmation display.

**Clear memory YES** is displayed.

- If you do not want to clear the memory that you have selected, push **MULTI-CONTROL** left. The display reverts to normal.

#### 5 Press MULTI-CONTROL to delete the Phone Book entry.

**Cleared** is displayed.

The Phone Book entry is deleted. The display returns to Phone Book entry list.

### Using the call history



#### Important

Be sure to park your vehicle and apply the parking brake when performing this operation.

The 12 most recent calls made (dialled), received and missed, are stored in the call history. You can browse the call history and call numbers from it.

#### 1 Turn MULTI-CONTROL to display the list.

## Available accessories

### 2 Press D/Scrl to display the phone book.

Press **D/Scrl** repeatedly to switch between the following lists:

Phone book—Missed call—Dialled call—Received call

- For more details about the Phone Book list, refer to *Using the phone book* on page 58.
- If no phone numbers are stored in the selected list, **No data** is displayed.

### 3 Turn MULTI-CONTROL to select a phone number.

Turning **MULTI-CONTROL** to change the phone numbers stored in the list.

- If the phone number is already in the phone book, the corresponding name is displayed.
- You can also change the phone number by pushing **MULTI-CONTROL** up or down.

### 4 Push MULTI-CONTROL right to display the detailed list.

Name and phone number are displayed in the detailed list.

- If the number is already in the Phone Book then the name is also displayed.
- Turning **MULTI-CONTROL** switches to the previous or next phone number displayed in the detailed list.
- If you do not operate functions other than *Editing the name of a Phone Book entry* and *Editing phone numbers* within about 30 seconds, the display automatically returns to the ordinary display.

### 5 Press MULTI-CONTROL to make a call.

- For an international call, press and hold **MULTI-CONTROL** to add + to the phone number.

### 6 To end the call, push MULTI-CONTROL down.

## Making a call by entering phone number



### Important

Be sure to park your vehicle and apply the parking brake when performing this operation.

### 1 Use MULTI-CONTROL to select Number dial in the function menu.

Refer to *Function and operation* on page 56.

### 2 Push MULTI-CONTROL up or down to select a number.

### 3 Push MULTI-CONTROL left or right to move the cursor to the previous or next position.

- Up to 24 digits can be entered.

### 4 When you finish entering the number, press MULTI-CONTROL.

Call confirmation appears.

- Pushing **MULTI-CONTROL** right in the confirmation display returns you to the number input display, and you can reenter the phone number.

### 5 Press MULTI-CONTROL to make a call.

### 6 To end the call, push MULTI-CONTROL down.

## Clearing memory

### 1 Use MULTI-CONTROL to select Clear memory in the function menu.

Refer to *Function and operation* on page 56.

### 2 Push MULTI-CONTROL up or down to select an item.

Each time **MULTI-CONTROL** is pushed up or down, the items are switched in the following order:

**Phone book** (phone book)—**Missed calls** (missed call history)—**Dialed calls** (dialled call history)—**Received calls** (received call history)—**Dial preset** (preset phone numbers)—**All clear** (delete all memory)

- If you want to clear all the Phone Book, dialled/received/missed call history list and preset phone number, select **All clear**.
- If guest phone is connected to this unit via Bluetooth wireless technology, **Phone book** cannot be selected.

**3 Push MULTI-CONTROL right to determine the item that you want to delete from this unit.**

**Clear memory YES** is displayed. Clearing memory is now on standby.

▪ If you do not want to clear the memory that you have selected, push **MULTI-CONTROL** left. The display reverts to normal.

**4 Press MULTI-CONTROL to clear the memory.**

**Cleared** is displayed and data on the selected item is cleared from this unit's memory.

## Setting automatic rejecting

**1 Use MULTI-CONTROL to select Refuse calls in the function menu.**

Refer to *Function and operation* on page 56.

**2 Press MULTI-CONTROL to turn automatic call rejection on.**

▪ To turn automatic call rejection off, press **MULTI-CONTROL** again.

## Setting automatic answering

**1 Use MULTI-CONTROL to select Auto answer in the function menu.**

Refer to *Function and operation* on page 56.

**2 Press MULTI-CONTROL to turn automatic answering on.**

▪ To turn automatic answering function off, press **MULTI-CONTROL** again.

## Switching the ring tone

**1 Use MULTI-CONTROL to select Ring tone in the function menu.**

Refer to *Function and operation* on page 56.

**2 Press MULTI-CONTROL to turn the ring tone on.**

▪ To turn the ring tone off, press **MULTI-CONTROL** again.

## Echo canceling and noise reduction

**1 Use MULTI-CONTROL to select Echo cancel in the function menu.**

Refer to *Function and operation* on page 56.

**2 Press MULTI-CONTROL to turn echo canceling on.**

▪ To turn echo canceling off, press **MULTI-CONTROL** again. 

## Multi-CD Player

### Basic Operations

You can use this unit to control a multi-CD player, which is sold separately.

- Only functions described in this section can be operated.
- Only functions described in this manual are supported by 50-disc multi-CD players.
- This unit is not designed to operate disc title list functions with a 50-disc multi-CD player. For information about the disc title list functions, refer to *Selecting discs from the disc title list* on page 65.



- ① Disc number indicator
  - ② Track number indicator
  - ③ Play time indicator
  - ④ Voltage indicator  
Shows the battery voltage.
    - The level displayed on the voltage indicator may differ from the actual voltage level.
- **Select a disc**  
Push **MULTI-CONTROL** up or down.

## Available accessories

### ● Fast forward or reverse

Push and hold **MULTI-CONTROL** left or right.

### ● Select a track

Push **MULTI-CONTROL** left or right.

### Notes

- When multi-CD player completes preparatory operations, **READY** is displayed.
- If an error message is displayed, refer to the multi-CD player owner's manual.
- If there are no discs in the multi-CD player magazine, **NO DISC** is displayed.

## Using CD TEXT functions

*You can use these functions only with a CD TEXT compatible multi-CD player.*

The operation is the same as that of the built-in CD player.

Refer to *Displaying text information on disc* on page 15.

## Introduction to advanced operations

*You can only use **Compression** (compression and DBE) with a multi-CD player that supports them.*

**1 Press MULTI-CONTROL to display the main menu.**

**2 Use MULTI-CONTROL to select FUNCTION.**

Turn to change the menu option. Press to select.

**3 Turn MULTI-CONTROL to select the function.**

**Play mode** (repeat play)—**Random mode** (random play)—**Scan mode** (scan play)—**Pause** (pause)—**Compression** (compression and DBE)—**ITS play mode** (ITS play)—**ITS memo** (ITS programming)—**TitleInput "A"** (disc title input)

- If you do not operate functions other than **ITS memo** and **TitleInput "A"** within about 30 seconds, the display automatically returns to the ordinary display.
- When playing a CD TEXT disc on a CD TEXT compatible multi-CD player, you cannot switch to **TitleInput "A"**. The disc title is already recorded on the CD TEXT disc.

## Function and operation

**Play mode, Random mode, Scan mode,**

**Pause** and **TitleInput "A"** operations are basically the same as that of the built-in CD player.

Function name	Operation
<b>Play mode</b>	Refer to <i>Selecting a repeat play range</i> on page 16. However, the repeat play ranges you can select are different from that of the built-in CD player. The repeat play ranges of the multi-CD player are: <ul style="list-style-type: none"> <li>• <b>M-CD repeat</b> – Repeat all discs in the multi-CD player</li> <li>• <b>Track repeat</b> – Repeat just the current track</li> <li>• <b>Disc repeat</b> – Repeat the current disc</li> </ul>
<b>Random mode</b>	Refer to <i>Playing tracks in random order</i> on page 16.
<b>Scan mode</b>	Refer to <i>Scanning folders and tracks</i> on page 17.
<b>Pause</b>	Refer to <i>Pausing playback</i> on page 17.
<b>TitleInput "A"</b>	Refer to <i>Entering disc titles</i> on page 17.

### Notes

- To return to the playback display, press **B**.
- If you select other discs during repeat play, the repeat play range changes to **M-CD repeat**.
- If you perform track search or fast forward/reverse during **Track repeat**, the repeat play range changes to **Disc repeat**.

- After track or disc scanning is finished, normal playback of the tracks begins again.

## Using compression and bass emphasis

You can only use these functions with a multi-CD player that supports them.

COMP (compression) and DBE (dynamic bass emphasis) functions lets you adjust the sound playback quality of the multi-CD player.

### 1 Use MULTI-CONTROL to select Compression in the function menu.

Refer to *Introduction to advanced operations* on the previous page.

- If the multi-CD player does not support COMP/DBE, **No COMP** is displayed when you attempt to select it.

### 2 Press MULTI-CONTROL to select your favorite setting.

**COMP OFF—COMP 1—COMP 2—  
COMP OFF—DBE 1—DBE 2**

## Using ITS playlists

ITS (instant track selection) lets you make a playlist of favorite tracks from the multi-CD player magazine. After you have added your favorite tracks to the playlist, you can turn on ITS play and play just those selections.

You can use ITS to enter and play back up to 99 tracks per disc from up to 100 discs (with the disc titles). (With multi-CD players sold before the CDX-P1250 and CDX-P650, up to 24 tracks can be stored in the playlist.)

## Creating a playlist with ITS programming

### 1 Play a CD that you want to program.

Push **MULTI-CONTROL** up or down to select the CD.

### 2 Use MULTI-CONTROL to select ITS memo in the function menu.

Refer to *Introduction to advanced operations* on the previous page.

### 3 Select the desired track by pushing MULTI-CONTROL left or right.

### 4 Push MULTI-CONTROL up to store the currently playing track in the playlist.

**Memory complete** is displayed and the currently playing selection is added to your playlist.

### 5 Press B to return to the playback display.



#### Note

After data for 100 discs is stored in memory, data for a new disc will overwrite the oldest one.

## Playback from your ITS playlist

ITS play lets you listen to the tracks that you have entered into your ITS playlist. When you turn on ITS play, tracks from your ITS playlist in the multi-CD player begin to play.

### 1 Select the repeat range.

Refer to *Playing tracks in random order* on page 16.

### 2 Use MULTI-CONTROL to select ITS play mode in the function menu.

Refer to *Introduction to advanced operations* on the previous page.

### 3 Press MULTI-CONTROL to turn ITS play on.

**ITS play** appears in the display. Playback begins of those tracks from your playlist within the previously selected **M-CD repeat** or **Disc repeat** ranges.

- If no tracks in the current range are programmed for ITS play, then **ITS empty** is displayed.
- To turn ITS play off, press **MULTI-CONTROL** again.

## Erasing a track from your ITS playlist

You can delete a track from your ITS playlist if ITS play is on.



## Available accessories

If ITS play is already on, skip to step 2. If ITS play is off, use **MULTI-CONTROL**.

### 1 Play the CD with the track you want to delete from your ITS playlist, and turn ITS play on.

Refer to *Playback from your ITS playlist* on the previous page.

### 2 Use MULTI-CONTROL to select ITS memo in the function menu.

Refer to *Introduction to advanced operations* on page 63.

### 3 Select the desired track by pushing MULTI-CONTROL left or right.

### 4 Push MULTI-CONTROL down to erase the track from your ITS playlist.

The currently playing selection is erased from your ITS playlist and playback of the next track begins.

- If there are no tracks from your playlist in the current range, **ITS empty** is displayed and normal playback resumes.

### 5 Press B to return to the playback display.

## Erasing a CD from your ITS playlist

You can delete all tracks of a CD from your ITS playlist if ITS play is off.

### 1 Play the CD that you want to delete.

Push **MULTI-CONTROL** up or down to select the CD.

### 2 Use MULTI-CONTROL to select ITS memo in the function menu.

Refer to *Introduction to advanced operations* on page 63.

### 3 Push MULTI-CONTROL down to erase all tracks on the currently playing CD from your ITS playlist.

All tracks on the currently playing CD are deleted from your playlist and **Memory deleted** is displayed.

### 4 Press B to return to the playback display.

## Using disc title functions

You can input CD titles and display the titles. Then, you can easily search for and play a desired disc.

### Entering disc titles

Use the disc title input feature to store up to 100 CD titles (with ITS playlist) into the multi-CD player. Each title can be up to 10 characters long.

For details concerning operation, refer to *Entering disc titles* on page 17.

- Titles remain in the memory even after the disc is removed from the magazine, and are recalled when the disc is reinserted.
- After data for 100 discs is stored in memory, data for a new disc will overwrite the oldest one.

### Displaying disc titles



#### ● Press D/Scrl to select the desired text information.

##### • For title entered CD

Play time—: disc title and play time

##### • For CD TEXT discs

Play time—: disc artist name and : track title

—: disc artist name and : disc title

—: track title and : track title

—: track title and play time

- You can scroll through text data by pressing and holding **D/Scrl**.

### Selecting discs from the disc title list

Disc title list lets you see the list of disc titles entered in the multi-CD player and select one of them to play back.

#### ● Use MULTI-CONTROL to select the desired disc title.

Turn to change the disc title. Press to play.

## Available accessories

- You can also change the disc title by pushing **MULTI-CONTROL** up or down.
- When playing CD TEXT disc, push **MULTI-CONTROL** right to see a list of the tracks in the selected disc. Push **MULTI-CONTROL** left to return to the disc list.
  - If no title is entered for a disc, **NO TITLE** is displayed.
  - **NO DISC** is displayed next to the disc number when there is no disc in the magazine.
  - You can scroll through text data by pressing and holding **D/Scrl**.
  - If you do not operate the list within about 30 seconds, the display automatically returns to the ordinary display. 

## DVD Player

### Basic Operations

You can use this unit to control a DVD player or multi-DVD player, which is sold separately.

For details concerning operation, refer to the DVD player's or multi-DVD player's operation manual. This section provides information on DVD operations with this unit which differs from that described in the DVD player's or multi-DVD player's operation manual.

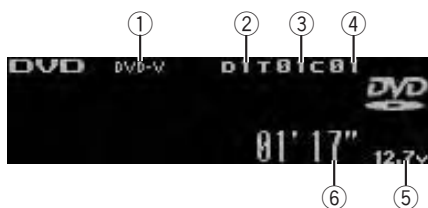

- ① **DVD-V/VCD/CD/MP3/WMA** indicator  
Shows the type of disc currently playing.
- ② Disc number indicator  
Shows the number of the disc currently playing when using a multi-DVD player.
- ③ Title/Folder number indicator  
Shows the title (when playing DVD video) or folder (when playing compressed audio) of the selection currently playing.
- ④ Chapter/track number indicator

Shows the chapter (when playing DVD video) or track (when playing Video CD, CD or compressed audio) currently playing.

- ⑤ Voltage indicator  
Shows the battery voltage.
  - The level displayed on the voltage indicator may differ from the actual voltage level.
- ⑥ Play time indicator

● **Select a chapter/track**  
Push **MULTI-CONTROL** left or right.

● **Fast forward or reverse**  
Push and hold **MULTI-CONTROL** left or right.
 

- When playing compressed audio, there is no sound on fast forward or reverse.

● **Select a disc/title**  
**VCD/CD:** Push **MULTI-CONTROL** up or down.  
**DVD-V/MP3/WMA:** Push and hold **MULTI-CONTROL** up or down.

● **Select a folder**  
Push **MULTI-CONTROL** up or down.
 

- You can operate this function only when a DVD player compatible with compressed audio playback is connected to this unit.
- You cannot select a folder that does not have a compressed audio file recorded in it.

## Introduction to advanced operations

1 Press **MULTI-CONTROL** to display the main menu.

2 Use **MULTI-CONTROL** to select **FUNCTION**.

Turn to change the menu option. Press to select.

3 Turn **MULTI-CONTROL** to select the function.

**During DVD video or Video CD playback**  
**Play mode** (repeat play)—**Pause** (pause)  
**During CD playback**

## Available accessories

**Play mode** (repeat play)—**Random mode** (random play)—**Scan mode** (scan play)—**Pause** (pause)—**ITS play mode** (ITS play)—**ITS memo** (ITS input)—**TitleInput "A"** (disc title input)

**During compressed audio playback**  
**Play mode** (repeat play)—**Random mode** (random play)—**Scan mode** (scan play)—**Pause** (pause)

- To return to the playback display, press **B**.
- If you do not operate functions except for **ITS memo** and **TitleInput "A"** within about 30 seconds, the display is automatically returned to the ordinary display.

### Function and operation

**Play mode**, **Random mode**, **Scan mode**, **Pause** and **TitleInput "A"** operations are basically the same as that of the built-in CD player. Also, **ITS play mode** and **ITS memo** operations are basically the same as that of the multi-CD player.

Function name	Operation
<b>Play mode</b>	<p>Refer to <i>Selecting a repeat play range</i> on page 16.            But the repeat play range that you can select is vary depending on the type of disc or system. The repeat play ranges of the DVD player/multi-DVD player are as below:            During PBC playback of Video CDs, this function cannot be operated.</p> <ul style="list-style-type: none"> <li>• <b>Disc repeat</b> – Repeat the current disc</li> <li>• <b>Folder repeat</b> – Repeat the current folder</li> <li>• <b>Title repeat</b> – Repeat just the current title</li> <li>• <b>Chapter repeat</b> – Repeat just the current chapter</li> <li>• <b>Track repeat</b> – Repeat the current track</li> </ul>
<b>Random mode</b>	Refer to <i>Playing tracks in random order</i> on page 16.
<b>Scan mode</b>	Refer to <i>Scanning folders and tracks</i> on page 17.

<b>Pause</b>	Refer to <i>Pausing playback</i> on page 17.
<b>ITS play mode</b>	Refer to <i>Using ITS playlists</i> on page 64.
<b>ITS memo</b>	Refer to <i>Using ITS playlists</i> on page 64.
<b>TitleInput "A"</b>	Refer to <i>Entering disc titles</i> on page 17.



### Notes

- If you select other discs during repeat play, the repeat play range changes to **Disc repeat**.
- When playing back Video CD or CD, if you perform track search or fast forward/reverse during **Track repeat**, the repeat play range changes to **Disc repeat**.
- When playing back compressed audio, if you select another folder during repeat play, the repeat play range changes to **Disc repeat**.
- When playing back compressed audio, if you perform track search or fast forward/reverse during **Track repeat**, the repeat play range changes to **Folder repeat**.
- Multi-DVD player that has ITS functions and disc title functions can also be connected to this unit. In this case, **ITS play mode**, **ITS memo** and disc title input can be controlled.
- The ITS function of a DVD player differs slightly from ITS playback with a multi-CD player. With multi-DVD player, ITS playback applies only to the CD playing. For details, refer to *Using ITS playlists* on page 64. ■

## Additional Information

### Error messages

When you contact your dealer or your nearest Pioneer Service Center, be sure to have the error message recorded.

#### Built-in CD Player

Message	Cause	Action
<b>ERROR-11, 12, 17, 30</b>	Dirty disc	Clean disc.
	Scratched disc	Replace disc.
<b>ERROR-10, 11, 12, 15, 17, 30, A0</b>	Electrical or mechanical	Turn the ignition switch OFF and back ON, or switch to a different source, then back to the CD player.
<b>ERROR-15</b>	The inserted disc does not contain any data	Replace disc.
<b>ERROR-22, 23</b>	The CD format cannot be played back	Replace disc.
<b>NO AUDIO</b>	The inserted disc does not contain any files that can be played back	Replace disc.
<b>TRK SKIPPED</b>	The inserted disc contains WMA files that are protected by DRM	Replace disc.
<b>PROTECT</b>	All the files on the inserted disc are secured by DRM	Replace disc.

#### USB storage device

Message	Cause	Action
<b>NO AUDIO</b>	No songs	Transfer the audio files to the external storage device and connect.
	USB storage device with security enabled is connected	Follow the USB storage device instructions to disable the security.
<b>NO DEVICE</b>	The USB storage device or iPod is not connected to the USB port of this unit.	Connect a compatible USB storage device.

<b>TRK SKIPPED</b>	The connected USB storage device contains WMA files that are protected by Windows Media Center™ DRM 9/10	Play an audio file not protected by Windows Media DRM 9/10.
<b>PROTECT</b>	All the files in the USB storage device are protected by Windows Media DRM 9/10	Transfer audio files not protected by Windows Media DRM 9/10 to the USB storage device and connect.
<b>NOT COMPATIBLE</b>	The USB storage device connected to is not supported by this unit.	Connect a USB storage device that is USB Mass Storage Class compliant.
<b>CHECK USB</b>	The USB connector or USB cable is short-circuited.	Confirm that the USB connector or USB cable is not caught in something or damaged.
	The connected USB storage device consumes more than 500 mA (maximum allowable current).	Disconnect the USB storage device and do not use it. Turn the ignition switch to OFF, then to ACC or ON and then connect the compliant USB storage device.
<b>ERROR-19</b>	Communication failure	Perform one of the following operations. –Turn the ignition switch OFF and back ON. –Disconnect or eject the USB storage device. –Change to a different source. Then, return to the USB source.
<b>ERROR-23</b>	USB storage device is not formatted with FAT16 or FAT32	USB storage device should be formatted with FAT16 or FAT32.

## Additional Information

### iPod

Message	Cause	Action
<b>ERROR-19</b>	Communication failure	Disconnect the cable from iPod. Once iPod main menu is displayed, connect the cable again. Reset the iPod.
	iPod failure	Disconnect the cable from iPod. Once iPod main menu is displayed, connect the cable again. Reset the iPod.
<b>ERROR-16, 18</b>	Old version of iPod	Update the iPod version.
	iPod failure	Disconnect the cable from iPod. Once iPod main menu is displayed, connect the cable again. Reset the iPod.
<b>ERROR-A1 CHECK USB</b>	iPod is not charged but operates correctly	Check if the connection cable for iPod shorted out (e.g., not caught in metal objects). After checking, turn the ignition switch OFF and back ON or disconnect the iPod and connect again.
<b>NO SONGS</b>	No songs	Transfer the songs to iPod.
<b>STOP</b>	No songs in the current list	Select a list that contains the songs.
<b>NO DEVICE</b>	The USB storage device or iPod is not connected to the USB port of this unit.	Connect a compatible iPod.



## Understanding auto TA and EQ error messages

When correct measurement of car interior acoustic characteristics is not possible using the auto TA and EQ, an error message may appear on the display. If an error message appears, refer to the table below to see what the problem is and the suggested method of correcting the problem. After checking, try again.

Message	Cause	Action
<b>ERR:MIC check</b>	Microphone is not connected.	Plug the supplied microphone securely into the jack.
<b>ERR:High Band, ERR:High-Lch, ERR:High-Rch, ERR:Mid Band, ERR:Mid-Lch, ERR:Mid-Rch, ERR:Low Band, ERR:Low-Lch, ERR:Low-Rch, ERR:SUBWOOFER, ERR:SW-Lch, ERR:SW-Rch</b>	The microphone cannot pick up the measuring tone of a speaker.	<ul style="list-style-type: none"> <li>• Confirm that the speakers are connected correctly.</li> <li>• Correct the input level setting of the power amp connected to the speakers.</li> <li>• Set the microphone correctly.</li> </ul>
<b>ERR:Outside Noise</b>	The surrounding noise level is too high.	<ul style="list-style-type: none"> <li>• Stop your car in a place that is as quiet as possible, and switch off the engine, air conditioner or heater.</li> <li>• Set the microphone correctly.</li> </ul>



## Additional Information

### Handling guideline of discs and player

- Use only discs featuring either of following two logos.



- Use only conventional, fully circular discs. Do not use shaped discs.



- Use a 12-cm CD. Do not use an 8-cm disc.
- Do not insert anything other than a CD into the CD loading slot.
- Do not use cracked, chipped, warped, or otherwise damaged discs as they may damage the player.
- Unfinalized CD-R/CD-RW disc playback is not possible.
- Do not touch the recorded surface of the discs.
- Store discs in their cases when not in use.
- Avoid leaving discs in excessively hot environments including under direct sunlight.
- Do not attach labels, write on or apply chemicals to the surface of the discs.
- To clean a CD, wipe the disc with a soft cloth outward from the center.
- Condensation may temporarily impair the player's performance. Leave it to adjust to the warmer temperature for about one hour. Also, wipe any dump discs with a soft cloth.
- Playback of discs may not be possible because of disc characteristics, disc format, recorded application, playback environment, storage conditions, and so on.

- Text information may not be correctly displayed depending on the recorded environment.
- Road shocks may interrupt disc playback.
- Read the precautions for discs before using them.

### DualDiscs

- DualDiscs are two-sided discs that have a recordable CD for audio on one side and a recordable DVD for video on the other.
- Since the CD side of DualDiscs is not physically compatible with the general CD standard, it may not be possible to play the CD side with this unit.
- Frequent loading and ejecting of a DualDisc may result in scratches on the disc. Serious scratches can lead to playback problems on this unit. In some cases, a DualDisc may become stuck in the disc loading slot and will not eject. To prevent this, we recommend you refrain from using DualDisc with this unit.
- Please refer to the information from the disc manufacturer for more detailed information about DualDiscs.

### Handling guideline of USB storage device and this unit

- This unit can play back files in the USB portable audio player/USB memory that is USB Mass Storage Class.
- Optimum performance of this unit may not be obtained depending on the connected USB storage device.
- Do not leave the USB storage device in any place with high temperatures.
- Depending on the kind of USB storage device you use, this unit may not recognize the storage device or file may not be played back properly.
- Operations may vary depending on the kind of a USB storage device.

## Additional Information

- You cannot connect a USB storage device to this unit via a USB hub.
- Do not plug anything other than the USB storage device into the USB port.
- Firmly secure the USB storage device when driving. Do not let the USB storage device fall onto the floor, where it may become jammed under the brake or accelerator pedal.
- Partitioned USB storage device is not compatible with this unit.
- Depending on the USB storage device connected to this unit, it may generate noise in the radio. 

### Compressed audio compatibility (disc, USB)

#### WMA

- Compatible format: WMA encoded by Windows Media Player
- File extension: .wma
- Bit rate: 48 kbps to 320 kbps (CBR), 48 kbps to 384 kbps (VBR)
- Sampling frequency: 32 kHz to 48 kHz
- Windows Media Audio Professional, Lossless, Voice: No

#### MP3

- File extension: .mp3
- Bit rate: 8 kbps to 320 kbps (CBR, VBR)
- Sampling frequency: 16 kHz to 48 kHz (32, 44.1, 48 kHz for emphasis)
- Compatible ID3 tag version: 1.0, 1.1, 2.2, 2.3, 2.4 (ID3 tag Version 2.x is given priority than Version 1.x.)
- M3u playlist: No
- MP3i (MP3 interactive), mp3 PRO: No

#### AAC

- Compatible format: AAC encoded by iTunes
- File extension: .m4a
- Transmission rate: 16 kbps to 320 kbps (CBR)
- Sampling frequency: 11.025 kHz to 48 kHz
- Apple Lossless: No

#### WAV

- Compatible format: Linear PCM (LPCM), MS ADPCM
- File extension: .wav
- Quantization bits: 8 and 16 (LPCM), 4 (MS ADPCM)
- Sampling frequency: 16 kHz to 48 kHz (LPCM), 22.05 kHz to 44.1 kHz (MS ADPCM)

### Supplemental information of compressed audio (disc, USB)

- There may be a slight delay when starting playback of audio files encoded with image data.
- File extensions must be used properly.
- Only 32 characters from the beginning can be displayed as a file name (including the extension) or a folder name.
- Russian text to be displayed on this unit should be encoded with the following character sets:
  - Unicode (UTF-8, UTF-16)
  - Character sets other than Unicode that are used in Windows environment and are set to Russian in the multi-language setting
- The text information of some audio files may not be correctly displayed. 

### Compressed audio files on the disc

- ISO 9660 Level 1 and 2 compliant. Romeo and Joliet file systems are both compatible with this player.
- Multi-session playback is possible.
- Compressed audio files are not compatible with packet write data transfer.
- Regardless of the length of blank section between the songs of original recording, compressed audio discs play with a short pause between songs. 

## Additional Information

### Compressed audio files in the USB storage device

About USB storage device compatibility, refer to *Specifications* on page 75.

- Copyright protected files cannot be played back.
- There may be a slight delay when starting playback of audio files on a USB storage device with numerous folder hierarchies. 

### Example of a hierarchy and playback sequences

 Folder

 Compressed audio file

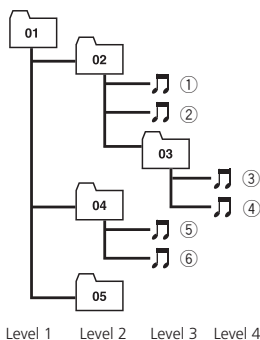

### The sequence of audio files on the USB storage device

*For USB portable audio players, the sequence is different and depends on the player.*

- 01 to 05 represent assigned folder numbers. ① to ⑥ represent the playback sequence. The user cannot assign folder numbers and specify the playback sequence with this unit.
- Playback sequence is the same as recorded sequence in the USB storage device.
- To specify the playback sequence, the following method is recommended.
  - 1 Create the file name including numbers that specify the playback sequence (e.g., 001xxx.mp3 and 099yyy.mp3).
  - 2 Put those files into a folder.
  - 3 Record the folder containing files into the USB storage device.

However, depending on the system environment, you cannot specify the playback sequence.

- Up to 15 000 files in a USB storage device can be played back.
- Up to 500 folders in a USB storage device can be played back.
- Up to eight tiers directory in a USB storage device can be played back. 

### The sequence of audio files on the disc

- This unit assigns folder numbers. The user cannot assign folder numbers.
- Folder selection sequence or other operation may be altered depending on the encoding or writing software.
- For practical use, the folder hierarchy should have as few tiers as possible.
- Up to 999 files on a disc can be played back.
- Up to 99 folders on a disc can be played back.

## iPod

### iPod compatibility

- This unit supports only the following iPod models. Supported iPod software versions are shown below. Older versions of iPod software may not be supported.
  - iPod nano first generation (software version 1.3.1)
  - iPod nano second generation (software version 1.1.3)
  - iPod nano third generation (software version 1.1.2)
  - iPod nano fourth generation (software version 1.0.3)



## Additional Information

- iPod fifth generation (software version 1.3.0)
- iPod classic (software version 1.1.2)
- iPod touch (software version 2.0)
- iPhone (software version 2.0)
- iPhone 3G (software version 2.0)
- Depending on the generation or version of the iPod, some functions can not be operated.
- Operations may vary depending on the software version of iPod.
- When using an iPod, iPod Dock Connector to USB Cable is required.
- Pioneer CD-IU50 interface cable is also available. For details, consult your dealer.
- This unit can control previous generations iPod models with a Pioneer iPod adapter (e.g. CD-IB100II).  
For details concerning operation with the iPod adapter, refer to *Playing songs on iPod* on page 50.

### About handling the iPod

- Do not leave the iPod in direct sunlight for extended amounts of time. Extended exposure to direct sunlight can result in iPod malfunction due to the resulting high temperature.
- Do not leave the iPod in a high temperature.
- Connect directly the dock connector cable to the iPod so that this unit works properly.
- Firmly secure the iPod when driving. Do not let the iPod fall onto the floor, where it may become jammed under the brake or accelerator pedal.
- For details, refer to the iPod's manuals.

### About iPod settings

- You cannot operate the iPod Equalizer on Pioneer products. We recommend that you set the iPod Equalizer to off, before connecting to this unit.
- You cannot set Repeat to off on the iPod when using this unit. Even if you set Repeat

to off on the iPod, Repeat is automatically changed to All when connecting the iPod to this unit. ■

## Copyright and trademark notice

### WMA



Windows Media and the Windows logo are trademarks or registered trademarks of Microsoft Corporation in the United States and/or other countries.

This product includes technology owned by Microsoft Corporation and cannot be used or distributed without a license from Microsoft Licensing, Inc.

### MP3

Supply of this product only conveys a license for private, non-commercial use and does not convey a license nor imply any right to use this product in any commercial (i.e. revenue-generating) real time broadcasting (terrestrial, satellite, cable and/or any other media), broadcasting/streaming via internet, intranets and/or other networks or in other electronic content distribution systems, such as pay-audio or audio-on-demand applications. An independent license for such use is required. For details, please visit <http://www.mp3licensing.com>.

### iTunes

Apple and iTunes are trademarks of Apple Inc., registered in the U.S. and other countries.

## Additional Information

### iPod



iPod is a trademark of Apple Inc., registered in the U.S. and other countries.

"Made for iPod" means that an electronic accessory has been designed to connect specifically to iPod and has been certified by the developer to meet Apple performance standards.

Apple is not responsible for the operation of this device or its compliance with safety and regulatory standards.

### iPhone



iPhone is a trademark of Apple Inc.

"Works with iPhone" means that an electronic accessory has been designed to connect specifically to iPhone and has been certified by the developer to meet Apple performance standards.

Apple is not responsible for the operation of this device or its compliance with safety and regulatory standards.

### SAT Radio



The SAT RADIO READY mark indicates that the Satellite Radio Tuner for Pioneer (i.e., XM tuner and Sirius satellite tuner which are sold separately) can be controlled by this unit.

Please inquire to your dealer or nearest authorized Pioneer service station regarding the satellite radio tuner that can be connected to this unit. For satellite radio tuner operation, please refer to the satellite radio tuner owner's manual.

- The system will use direct satellite-to-receiver broadcasting technology to provide listeners in their cars and at home with crystal-clear sound seamlessly from coast to coast. Satellite radio will create and package over 100 channels of digital-quality music, news, sports, talk and children's programming.
- "SAT Radio", the SAT Radio logo and all related marks are trademarks of Sirius Satellite Radio Inc., and XM Satellite Radio Inc.

### HD Radio Technology

- HD Radio™ and the HD Radio Ready logo are proprietary trademarks of iBiquity Digital Corp. 

# Additional Information

## Specifications

### General

Power source .....	14.4 V DC (10.8 V to 15.1 V allowable)
Grounding system .....	Negative type
Max. current consumption .....	2.0 A
Dimensions (W × H × D): DIN	
Chassis .....	178 mm × 50 mm × 164 mm (7 in. × 2 in. × 6-1/2 in.)
Nose .....	188 mm × 58 mm × 18 mm (7-3/8 in. × 2-1/4 in. × 3/4 in.)
D	
Chassis .....	178 mm × 50 mm × 164 mm (7 in. × 2 in. × 6-1/2 in.)
Nose .....	170 mm × 45 mm × 18 mm (6-3/4 in. × 1-3/4 in. × 3/4 in.)
Weight .....	1.6 kg (3.5 lbs)

### Audio/DSP

Preout max output level .....	5.0 V
Loudness contour .....	+10 dB (100 Hz), +6.5 dB (10 kHz) (volume: -30 dB)
Equalizer (Left/Right independent 31-Band Graphic Equalizer):	
Frequency .....	20/25/31.5/40/50/63/80/100/125/160/200/250/315/400/500/630/800/1k/1.25k/1.6k/2k/2.5k/3.15k/4k/5k/6.3k/8k/10k/12.5k/16k/20k Hz
Equalization range .....	±12 dB (0.5 dB step)
Time alignment .....	0 cm to 394.24 cm (0.77 cm/step), 0 inch to 155.392 inch (0.3035 inch/step)
Network (Left/Right independent):	
High:	
<b>LPF</b>	
Frequency .....	5k/6.3k/8k/10k/12.5k/16k/20k Hz
Slope .....	PASS, -6/-12/-18/-24/-30/-36 dB/oct
Gain .....	0 dB to -24 dB/Mute (1 dB step)
Phase .....	Normal/Reverse
<b>HPF</b>	
Frequency .....	800/1k/1.25k/1.6k/2k/2.5k/3.15k/4k/5k/6.3k/8k/10k/12.5k/16k Hz
Slope .....	-6/-12/-18/-24/-30/-36 dB/oct

Gain ..... 0 dB to -24 dB/Mute (1 dB step)

Phase ..... Normal/Reverse

Mid:

### HPF/LPF

Frequency (LPF) ... 25/31.5/40/50/63/80/100/125/160/200/250/315/400/500/630/800/1k/1.25k/1.6k/2k/2.5k/3.15k/4k/5k/6.3k/8k/10k/12.5k/16k/20k Hz

Frequency (HPF)

..... 20/25/31.5/40/50/63/80/100/125/160/200/250/315/400/500/630/800/1k/1.25k/1.6k/2k/2.5k/3.15k/4k/5k/6.3k/8k/10k/12.5k/16k Hz

Slope (LPF) ..... PASS, -6/-12/-18/-24/-30/-36 dB/oct

Slope (HPF) ..... PASS, -6/-12/-18/-24/-30/-36 dB/oct

Gain ..... 0 dB to -24 dB/Mute (1 dB step)

Phase ..... Normal/Reverse

Low:

### HPF/LPF

Frequency (LPF) ... 25/31.5/40/50/63/80/100/125/160/200/250/315/400/500/630/800/1k/1.25k/1.6k/2k/2.5k/3.15k/4k/5k/6.3k/8k/10k/12.5k/16k/20k Hz

Frequency (HPF)

..... 20/25/31.5/40/50/63/80/100/125/160/200/250/315/400/500/630/800/1k/1.25k/1.6k/2k/2.5k/3.15k/4k/5k/6.3k/8k/10k/12.5k/16k Hz

Slope (LPF) ..... PASS, -6/-12/-18/-24/-30/-36 dB/oct

Slope (HPF) ..... PASS, -6/-12/-18/-24/-30/-36 dB/oct

Gain ..... +6 dB to -24 dB/Mute (1 dB step)

Phase ..... Normal/Reverse

## Additional Information

SW:

**HPF/LPF**

Frequency (LPF) ... 25/31.5/40/50/63/80/100/125/  
160/200/250/315/400/500/  
630/800/1k/1.25k/1.6k/2k/  
2.5k/3.15k/4k/5k/6.3k/8k/  
10k/12.5k/16k/20k Hz

Frequency (HPF)

..... 20/25/31.5/40/50/63/80/100/  
125/160/200/250/315/400/  
500/630/800/1k/1.25k/1.6k/  
2k/2.5k/3.15k/4k/5k/6.3k/8k/  
10k/12.5k/16k Hz

Slope (LPF) ..... PASS, -6/-12/-18/-24/-30/  
-36 dB/oct

Slope (HPF) ..... PASS, -6/-12/-18/-24/-30/  
-36 dB/oct

Gain ..... +6 dB to -24 dB/Mute (1  
dB step)

Phase ..... Normal/Reverse

**CD player**

System ..... Compact disc audio system

Usable discs ..... Compact disc

Signal-to-noise ratio ..... 115 dB (1 kHz) (IHF-A net-  
work)

Number of channels ..... 2 (stereo)

MP3 decoding format ..... MPEG-1 & 2 Audio Layer 3

WMA decoding format ..... Ver. 7, 7.1, 8, 9, 10, 11 (2ch  
audio)  
(Windows Media Player)

AAC decoding format ..... MPEG-4 AAC (iTunes en-  
coded only) (.m4a)  
(Ver. 7.7 and earlier)

WAV signal format ..... Linear PCM & MS ADPCM  
(Non-compressed)

**USB**

USB standard specification

..... USB 2.0 full speed

Maximum current supply .... 500 mA

Minimum memory capacity

..... 256 MB

USB Class ..... MSC (Mass Storage Class)

File system ..... FAT16, FAT32

MP3 decoding format ..... MPEG-1 & 2 Audio Layer 3

WMA decoding format ..... Ver. 7, 7.1, 8, 9, 10, 11 (2ch  
audio)  
(Windows Media Player)

AAC decoding format ..... MPEG-4 AAC (iTunes en-  
coded only) (.m4a)  
(Ver. 7.7 and earlier)

WAV signal format ..... Linear PCM & MS ADPCM  
(Non-compressed)

**FM tuner**

Frequency range ..... 87.9 MHz to 107.9 MHz

Usable sensitivity ..... 9 dBf (0.8  $\mu$ V/75  $\Omega$  mono,  
S/N: 30 dB)

Signal-to-noise ratio ..... 72 dB (IHF-A network)

**AM tuner**

Frequency range ..... 530 kHz to 1 710 kHz (10  
kHz)

Usable sensitivity ..... 25  $\mu$ V (S/N: 20 dB)

Signal-to-noise ratio ..... 62 dB (IHF-A network)

**Note**

Specifications and the design are subject to mod-  
ifications without notice due to improvements. 

*Register your product at  
Enregistrez votre produit au*

**<http://www.pioneerelectronics.com>**

*See "Visit our website" page  
Voir la page "Visitez notre site Web"*

**PIONEER CORPORATION**

4-1, MEGURO 1-CHOME, MEGURO-KU  
TOKYO 153-8654, JAPAN

**PIONEER ELECTRONICS (USA) INC.**

P.O. Box 1540, Long Beach, California 90801-1540, U.S.A.  
TEL: (800) 421-1404

**PIONEER EUROPE NV**

Haven 1087, Keetberglaan 1, B-9120 Melsele, Belgium/Belgique  
TEL: (0) 3/570.05.11

**PIONEER ELECTRONICS ASIACENTRE PTE. LTD.**

253 Alexandra Road, #04-01, Singapore 159936  
TEL: 65-6472-7555

**PIONEER ELECTRONICS AUSTRALIA PTY. LTD.**

178-184 Boundary Road, Braeside, Victoria 3195, Australia  
TEL: (03) 9586-6300

**PIONEER ELECTRONICS OF CANADA, INC.**

300 Allstate Parkway, Markham, Ontario L3R 0P2, Canada  
TEL: 1-877-283-5901  
TEL: 905-479-4411

**PIONEER ELECTRONICS DE MEXICO, S.A. de C.V.**

Bldv.Manuel Avila Camacho 138 10 piso  
Col.Lomas de Chapultepec, Mexico, D.F. 11000  
TEL: 55-9178-4270

**先鋒股份有限公司**

總公司：台北市中山北路二段44號13樓  
電話：(02) 2521-3588

**先鋒電子（香港）有限公司**

香港九龍尖沙嘴海港城世界商業中心  
9樓901-6室  
電話：(0852) 2848-6488

Published by Pioneer Corporation.  
Copyright © 2009 by Pioneer Corporation.  
All rights reserved.

Printed in Japan

<CRB3070-A> UC

<KSNZF> <09D00000>