

Tabletop Freezer STG 85 A1

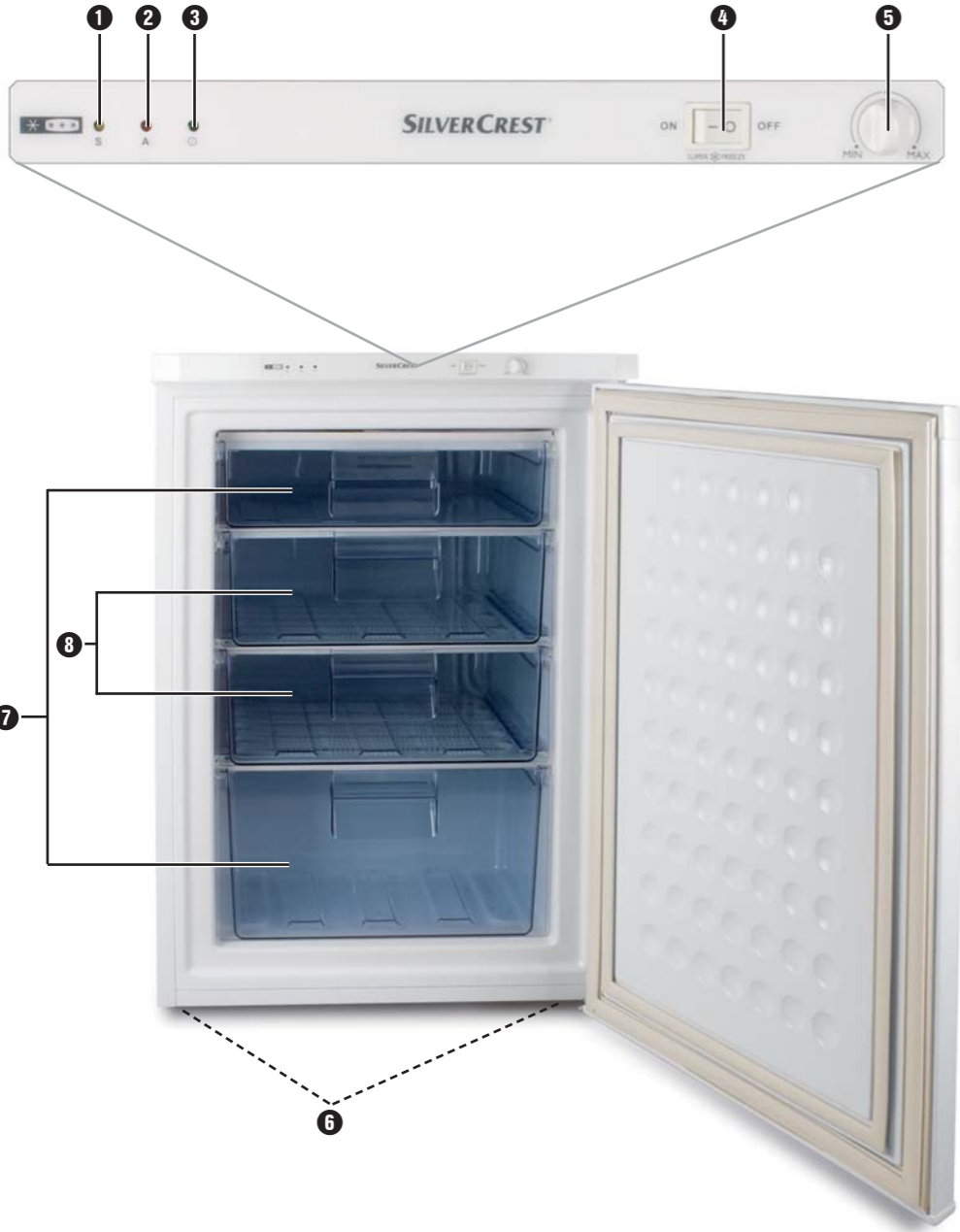

GB **Tabletop Freezer**
IE **Operating instructions**
CY



CONTENT	PAGE
Intended Use	2
Safety instructions	2
Technical data	3
Items supplied	4
Description of the appliance	4
Setting the appliance up	4
Ventilation	4
Laying and connecting the power cable	4
Protect against moisture and heat	4
Installation of the appliance.....	4
Start-up	5
Switching on	5
Control lamps	5
Storage times	6
Freezing fresh foods.....	6
Frozen Foods	6
Making ice cubes.....	7
Operating noises	7
Saving energy	7
Power failure	7
Defrosting	8
Cleaning and Care	8
Cleaning the interior	9
Cleaning the outside of the appliance.....	9
Prolonged non-usage.....	9
Changing the door hinging	9
Troubleshooting	10
Information about the refrigerant	11
Disposal	12
Warranty and Service	12
Importer	13

Read the operating instructions carefully before using the appliance for the first time and preserve this booklet for later reference. Pass the manual on to whomsoever might acquire the appliance at a later date.

Tabletop Freezer

Intended Use

This appliance is intended solely for the freezing of fresh foods and the storage of frozen foods. This appliance is not intended for industrial, commercial or laboratory use, only for employment in domestic households. **In cases of improper use there will be risk to life and limb** due to electric shock or fire.

In addition, the warranty will become void.

Safety instructions

Attention! Risk of electric shock!

- NEVER open the housing of your freezer. There are no user-serviceable elements inside. Arrange for repairs to be carried out by qualified specialist workshops that are approved and authorised by us.
- Never allow children to play with the appliance or insert anything into any of the openings. There will be a risk of a potentially fatal electric shock.
- Never touch the power cable with moist or wet hands! Never use a damaged power cable! This brings also the **risk of an electric shock**.
- Arrange for defective power plugs and/or cables to be replaced at once by qualified technicians or our Customer Service Department.

- The electrical safety regulations require that this equipment may **only be operated when it is earthed**. The manufacturer accepts no liability for injury to life or limb of persons resp. animals or property damage arising from any breach of these regulations.
- Before you connect the appliance, you must check to ensure that the power cable has withstood the transportation and is undamaged.
- The **electrical safety** of this appliance can only be assured when it is operating on **a properly connected and earthed household mains power socket**.
- When setting the appliance up, ensure that the appliance cannot damage the power cable.
- Before cleaning the appliance, disconnect it from the mains power supply or switch off the corresponding circuit breaker.

Risk of personal injury!

- This appliance is not intended for use by individuals (including children) with restricted physical, physiological or intellectual abilities or deficiencies in experience and/or knowledge unless they are supervised by a person responsible for their safety or receive from this person instruction in how the appliance is to be used.
- Children should be supervised to ensure that they do not play with the appliance.
- Use the appliance only for storing frozen foods or for freezing fresh food. Do not place glass containers containing liquids in the appliance, they may burst.
- Never take anything out of the freezer if you have wet/damp hands. You could get stuck to the frozen item.
- Do not eat ice lollipops immediately after removal from the freezer, otherwise they could cause frostbite or numbness.

- **DANGER!** NEVER allow children to play in a freezer or to hide in it! They could become trapped in the device and suffocate!

Risk of fire!

- Should the power cable be too short to reach an existing mains power socket, arrange for a qualified electrician to install a new one. Do not use extension cables or multi-plug sockets.
- Do not store or use petrol, gas or flammable liquids in the vicinity of the appliance or other electrical equipments. The vapours could cause a fire or an explosion.
- Never damage the pipes of the coolant circulation system.

Warning in regard to property damage!

- The appliance may only be operated in indoor spaces.
- This appliance is designed for operation with an alternating current power supply of 230V /50Hz. NEVER attempt to operate the appliance with a different power source rating.
- Wait at least 4 hours for the first start-up, so that the coolant has re-amassed.
- **If you have disconnected the appliance from the mains power supply, you must wait at least 5 minutes before you reconnect the appliance. If you do not, the compressor could be damaged.** In the event of a power failure, you should immediately unplug the appliance from the mains power socket. After 5 minutes you can re-connect it, regardless of whether the power supply is working again or not.
- Before plugging in, ensure that the voltage of your domestic power supply is the same as that indicated on the appliance typeplate.

- Do not locate the appliance near a source of heat (e.g. oven, electric heater).
- To ensure adequate ventilation, there must be sufficient clearance behind the appliance. In this regard, comply with the information provided for setting up the appliance.
- Ensure that the ventilation openings on the appliance are always clear.
- Take care to locate the appliance only on a surface that can also carry the weight of it.
- Move the appliance gently over the floor, so that you do not cause damage it (e.g., parquet floors).
- Do not use any mechanical, electrical or chemical method for defrosting, briefly any method other than those recommended by the manufacturer.
- Do not use or place any electrical devices in the interior of the freezer, unless they are expressly authorised by the manufacturer.

We exclude all liability for damages if one or more of the above safety instructions or general recommendations has not been complied with.

Technical data

Voltage :	230 V ~ / 50 Hz
Power consumption :	110 W
Rated current:	0,8 A
Volume:	85l (Total content, when all drawers (freezer compartments/storage compartments) are removed)
Freezing capacity:	10.5 kg in 24 hours
Storage time on defect:	14 hours

Items supplied

Tabletop Freezer
Ice cube mould
Operating instructions

Description of the appliance

- ❶ "Super Freeze" control lamp (yellow)
- ❷ Temperature control lamp (red)
- ❸ Operational control lamp (green)
- ❹ "Super Freeze" switch
- ❺ Temperature regulator
- ❻ Adjustable feet
- ❼ Storage compartments
- ❽ Freezer compartments 

Setting the appliance up

Note

While setting the appliance up, and also later should you want to relocate it, do not slope it by more than 45 °.

Ventilation

In order not to impede the heat exchange, and to ensure high cooling efficiency with low power consumption, a free space of 50 mm should remain above the appliance. Should this not be possible, then at least a space of 25 mm on each side of the appliance.

Laying and connecting the power cable

Connect the appliance via the power cable with a properly connected and earthed 230 V mains power socket. Do not use extension cables or multi-plug sockets. It must at all times be possible to disconnect the appliance from the mains power supply by simply removing the plug from the mains power socket. Route the power cable so that it does not make contact with the compressor of the appliance. This becomes hot during operation and could damage the insulation of the cable. Also ensure that the cable does not come under the adjustable feet ❻ or is in any way clamped and, because of this, could be damaged.

Protect against moisture and heat

Place the appliance in a dry and well ventilated room. The appliance is not suitable for operation outdoors. Protect the appliance from direct sunlight and do not place it near sources of heat such as stoves or radiators, etc.

Installation of the appliance

Ensure that the freezer is positioned horizontally on a stable surface. It works properly only in this position. Check that it is horizontal with a spirit level. To make any corrections, you can screw the the adjustable feet ❻ in or out. All adjustable feet ❻ must have solid contact to the undersurface so that the appliance stands firmly.

Attention!

To avoid the risk of fire, do not place electrical heaters on the freezer. Also, do not place kettles or water boilers on it, as overflowing boiling liquids could damage the electrical insulation of the appliance.

Start-up

Before commissioning, remove all paper and plastic packaging from the appliance. Check to ensure that the appliance is not damaged and the door closes properly. Clean the inside of the appliance (see chapter "Cleaning and Care").

Switching on

⚠ Attention!

Wait at least 4 hours for the first start-up, so that the coolant has re-amassed. If you do not, it would lead to irreparable damage to the appliance!

1. Connect the appliance via the power cable with a properly connected and earthed 230 V mains power socket.
2. Bring the temperature controller **5** into the desired position. The further you turn the regulator clockwise, the lower the temperature will be inside the appliance.

- MIN = relatively low cooling
- = normal setting
- MAX = lowest temperature, maximum cooling

- The appliance will take about four hours to reach the desired interior temperature. Please wait this long until you start to fill the appliance with frozen foods.

i Note

The cooling temperature is influenced by, ...

- ... how high the ambient room temperature is,
- ... how much food is stored in the appliance,
- ... how you have set the appliance up.

Please take note of all of these factors when setting the cooling temperature. Do not be afraid to experiment a little to find out which cooling temperature best suits your needs.

i Note

With the "super freeze function" you can in a short time set the maximum cooling performance. In this case it does not matter at what level the temperature regulator **5** is set.

Place the switch "Super Freeze" **4** at the ON position if you want to cool the appliance down before freezing fresh foods (see chapter "Freezing fresh foods").

Always distribute the food to be frozen evenly in the freezer compartments **6**.

Later, do not forget to place the switch **4** back into the OFF position.

Control lamps

- The operating control lamp (green) **3** glows constantly when the appliance is connected to the mains power supply. When you disconnect the appliance from the power mains or there is a power failure, then the lamp extinguishes.

- The temperature control lamp (red) **2** indicates a temperature in the freezer compartment that is too high. These may be the reasons for it:
 - the appliance was just connected to the mains power supply,
 - a larger quantity of food is being stored in the appliance than is admissible as given on the typeplate,
 - the appliance door has been left open for too long,
 - the temperature controller has just been turned clockwise and the appliance has not yet reached the desired temperature.

- The "Super Freeze" control lamp (yellow) **1** glows when the "Super Freeze" switch is brought into the ON position - the compressor then operates continuously.

Storage times

This freezer is suitable for the long-term storage of frozen foods. You can also freeze fresh foods in it and then store them there. The following list is intended as general information about how long you can store frozen foods in the appliance. In every case you should however pay heed to the storage instructions printed on the packaging of already frozen foods.

- Meat and poultry - up to 12 months
- Prepared Meats - up to 2 months
- Fresh fish - up to 6 months
- Fruits and vegetables - up to 12 months
- Bread and Cake - up to 6 months



Note

Write down the date of freezing on the package when you freeze fresh food yourself.

Attention!

Under no circumstances should you store liquids in bottles or cans in the appliance, because, when it freezes its volume also increases, which would lead to the bursting of the container! Risk of Injury!

Freezing fresh foods

1. If you want to freeze fresh food yourself, activate the "Super Freeze" feature around 24 hours beforehand, by moving the switch "Super Freeze"  into the ON position. The setting of the temperature controller  is for the moment unimportant, as the "Super Freeze" function, regardless of the setting of the temperature controller , always provides the maximum cooling performance.
2. Firmly pack the fresh foods into aluminum foil, plastic wrap or airtight and watertight plastic bags. You can also use plastic containers with lids or freezer boxes which are suitable for the freezing of fresh foods.

Note

Pack the foods in the smallest possible portions. Thus, the food freezes faster. You can freeze a maximum of 10.5 kg at one time.

3. Distribute the food to be frozen evenly in the freezer compartments .

Note

Ensure that the food being frozen does not come into contact with the already frozen foods. Otherwise they could defrost.

4. Deactivate the "Super Freeze" function after you have put the food in the appliance: Place the switch "Super Freeze"  at the OFF position and turn the temperature controller to a central position between "•" and "• MAX".

Note

Never freeze more than 10.5 kg at one time.

The foods will be completely frozen in 24 hours.

Frozen Foods

Please take note of the following when you buy already frozen products:

- Ensure that the packaging is not damaged. Damaged packaging may have a negative impact on the quality of frozen food. If the packaging shows signs of swelling or moist spots, the foods could have been frozen under adverse conditions and/or is already thawed.
- When shopping, select your frozen foods as the very last and transport them only in isolated cool bags.
- Place your frozen foods into the appliance immediately after you arrive home.
- Should the foods already be thawed, do not freeze them again, instead, consume them within 24 hours.

- Always comply with the information given on the packaging about storage.

Making ice cubes

Fill the ice cube mould to two thirds with water.
Place the ice cube mould level on the bottom of one of the freezer compartments **3**.

Operating noises

You may possibly hear a faint gurgle when the appliance pumps the coolant in the cooling system through the coils and pipes on the back of the appliance.

When the compressor is working, you can hear a slight rustling or pulsation.

The temperature controller controls the compressor and you may hear a slight click when it is switched on or off. All of this is completely normal and does not indicate a malfunction of the appliance!

Saving energy

- The cooler the ambient air, the less energy the appliance has to consume to deliver the desired cooling capacity. Accordingly, never locate the unit next to sources of heat such as radiators, stoves or dishwashers. Provide for sufficient ventilation.
- Do not leave the door open for longer than necessary. If you do, warm air will flow into the interior, which will lead to increased ice formation and cause an increase in energy consumption.
- Take care to ensure that no objects, or incompletely closed drawers, in the freezer compartments **3** or the storage compartments **7** impede the proper closing of the door.

Power failure

- If the power supply should suddenly fail, immediately disconnect the power cable from the mains power socket. After 5 minutes you can re-connect it, regardless of whether the power supply is working again or not.
- Should a power cut be planned, and therefore have a lead time, we recommend turning the temperature regulator **5** to the position "max" 2 - 3 hours beforehand and to switch the "Super-Freeze" function on.
- During the power cut avoid any unnecessary opening of the appliance door and place no foods in for storage.
- If the power cut lasts for a long time, when the power is switched back on check to see if melt water has collected on the bottoms of the freezer compartments **6** or on the bottoms of the storage compartments **7**. In this case, you must wipe the water up with a soft, dry cloth so that the foods do not freeze to these surfaces.
- Check the condition of the foods. Should they be slightly or even fully thawed, they should be removed from the appliance and consumed promptly.

Defrosting

Ice forms on the inside surfaces of the appliance through normal use. This is normal. How much ice is formed, and how quickly, is dependent on the ambient temperature, the humidity level and the frequency of door opening. If this ice is too thick, the cooling capacity and efficiency of the appliance will deteriorate.

If the ice layer is thicker than 3 - 5 mm you need to defrost the appliance. If possible, defrost the appliance when it is almost empty.

1. Disconnect the appliance from the power supply by removing the plug from the mains power socket.
2. Take the food out of the appliance, wrap it in newspaper and put it all together in a cool place or in a portable cooler box.
3. Leave the appliance with the door open until the ice has melted.

Appliance damage!

- Never use sharp-edged tools to separate the ice from the housing.
 - Do not use hot water or a hairdryer to accelerate the melting rate. This could damage the material of the interior walls.
4. Mop up the meltwater with a soft, dry cloth. Clean the inside surfaces with a sponge and some warm water and/or a neutral detergent.

Appliance damage!

Never use aggressive, chemical or abrasive cleansers! These could damage the surfaces.

5. Thoroughly dry the interior.

Note

Check the food to be refrozen to see if any of it has started to thaw. Do not refreeze food that has started to thaw, instead, consume it.

6. Place the food back into the freezer and close the door.
7. Connect the appliance once again to the mains power supply. Keep in mind that it will take some time until it reaches the desired cooling temperature.

Cleaning and Care

Danger of electrical shock

Before cleaning, ALWAYS remove the plug from the mains power socket. If you do not, there is the great risk of you receiving an electric shock!

Risk of Injury!

There may be some sharp edges below the appliance, please exercise care when cleaning it.

Appliance damage!

Never use aggressive, chemical or abrasive cleansers! These could damage the surfaces.

Note

After cleaning, always check the food to be refrozen to see if any of it has started to thaw. Do not refreeze food that has started to thaw. There is a risk that bacteria can form in it.

Cleaning the interior

- Allow the appliance to defrost as previously described.
- Clean the appliance with a soft cloth, warm water or a little neutral detergent.
- Dry the appliance thoroughly with a dry cloth.

We recommend a cleaning every month.

Cleaning the outside of the appliance

- Wipe the housing down with warm soapy water.
- Dry the housing thoroughly with a dry cloth.
- Once or twice a year use a brush or a vacuum cleaner to remove dust from the back of the unit and the compressor. This increases the performance and energy efficiency of the appliance.

Prolonged non-usage

- Take all foodstuffs out of the appliance.
- Unplug the appliance from the mains power supply.
- Defrost the appliance and clean the inside.
- Leave the door open during long periods of non-usage, so that mould, mildew, foul odours or oxidation cannot form.
- Regularly clean the appliance inside and out even when it is not in use.

Changing the door hinging

Subject to preference, the door of the freezer can open to either the right or the left. Decisive for this is the position of the door hinge. On delivery, the door hinge is fitted on the right.

⚠ Danger of electrical shock

Before changing the hinge, unplug the appliance from the mains power socket. Otherwise, there is the great risk of receiving an electric shock!

ⓘ Note

Changing the door hinge is easier to carry out when there is assistance from a second person.

1. Unscrew the two screws at the rear that secure the upper appliance cover. Pull the temperature control from the axle to the front by using pliers. Pull the upper appliance unit cover upwards and then press it forward. Turn it a little so that you have access to the screws on the top hinge. Then loosen the screws securing the top hinge and remove it (Fig. 1). Replace the screws back into the holes on the freezer.

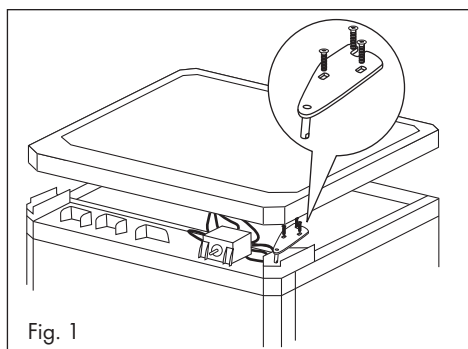

- Lean the appliance back a little and secure it so that it is safe. Completely unscrew and remove the front adjustable feet. Before you commence the next step, make preparations to prevent the appliance door from falling down. Remove the screws holding the lower door hinge and take the hinge off (Fig. 2). Replace the screws back into the holes on the freezer.

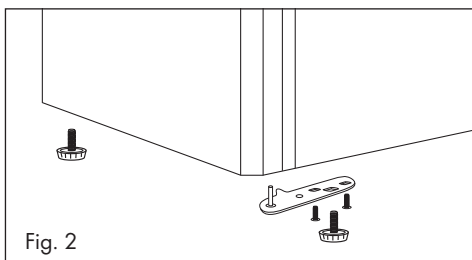

- Now lay the door to the side.
- Unscrew the nut of the lower door hinge off and remove the axle. Fit the axle on the other side. Now rescrew the nut tightly firmly back on the axle (Fig. 3).

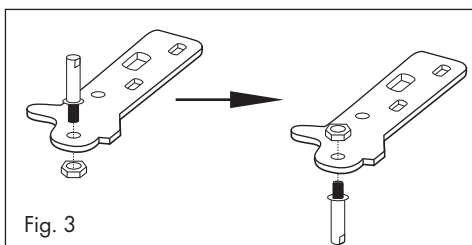

- You now have to reassemble the components on the opposite side. For this, unscrew the screws from the pre-drilled holes and screw the door hinge back on. Replace the adjustable feet. The adjustable foot with the long screwed thread must be located on the side where the door hinges are fixed. Bring the appliance back into the horizontal.
- Unscrew the axle of the upper door hinge. Turn the hinge around through 180 ° on its longitudinal axis and rescrew the axle back in (Fig. 4).

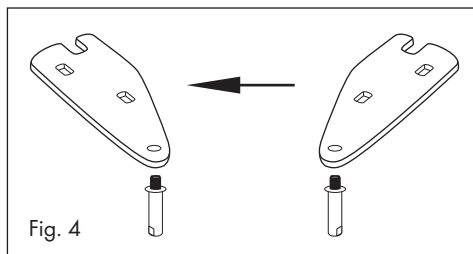

- Remove the white cap on the door bottom that covers the hole for the axis of the hinge. Replace the white cap in the now no longer needed hole.
- Now position the door on the axis of the lower hinge. Remove the screws for the top hinge from the holes on the opposite side of the freezer and screw the top hinge back on with the help of these screws, **but not yet firmly**.
- Now check the horizontal and vertical alignment of the door. Ensure that the sealing of the door sits firmly against its counterpart on the housing. First then do you secure all screws hand tight.
- Now replace the upper appliance cover and screw it down tightly using the corresponding screws. Refit the temperature controller on the axle so that it is firmly seated.

Troubleshooting

Should the problems or malfunctions described in the following occur in the operation of your appliance, please first try to resolve the problem by means of this checklist. If this does not help, please contact our Service Hotline.

The appliance doesn't work

- Is there possibly a power failure?
- Is the plug sitting firmly in the mains power socket?
- Is the circuit-breaker turned on in the residence?
- Is the power cable damaged? **CAUTION!** Check this only after you have removed the plug!
- Is the appliance possibly standing in direct sunlight or close to a source of heat?

The inside temperature does not sink deep enough

- Is the door is properly closed?
- Is the appliance possibly standing in direct sunlight or close to a source of heat?
- Is the temperature regulator **5** correctly set?
- Did you leave enough space around the appliance when setting it up ?

The inside temperature is too low

- Is the temperature regulator **5** correctly set?
- Is the "Super Freeze" function activated?

The appliance generates considerable noise

- Have you set the appliance up correctly according to these instructions?
- Does the appliance vibrate or does it hit on the back somewhere?
- The sounds described in the chapter "Operating noises" are harmless.

Strong ice formation on the inside

- Is the door is properly closed?
- Check that the door seal is clean.
- Is possibly some stored food preventing the correct closing of the door?
- Is the door being opened too often?

The compressor runs continuously

- Is the door is properly closed?
- Have you just frozen large quantities of food?
If yes, please allow the appliance a few hours to regain the desired cooling temperature.

- Is the door being opened too often?
- Is the "Super Freeze" function activated?

Condensation forms on the freezer interior surfaces

- Is the weather particularly hot or humid? This can cause increased condensation.
- Has the door been left open?
- Was the door opened very often or allowed to stand open for an extended period?

Condensation forms on the freezer exterior surfaces

- Is there especially high humidity at present? This can cause increased condensation on the exterior surfaces. As soon as the humidity decreases, the condensation will disappear.

It smells unpleasant in the freezer interior

- Does the interior need to be cleaned?
- Are perhaps packaging materials causing the smell?

Information about the refrigerant

This appliance contains the refrigerant Isobutane (R600a). Isobutane is a naturally occurring, low-polluting gas. Nevertheless, caution is advised, because Isobutane is a flammable gas. Therefore, you must make sure that the pipes of the cooling circuit cannot be damaged. Should it ever happen, you must avoid sparks and open flames. Do not smoke! Carefully ventilate the room!
Please contact the Service Hotline in conjunction with this.

Disposal



Do not dispose of the appliance in your normal domestic waste. This product is subject to the provisions of European Directive 2002/96/EC.

Dispose of the appliance through an approved disposal centre or at your community waste facility.

Observe the currently applicable regulations.

In case of doubt, please contact your waste disposal centre.



Dispose of all packaging materials in an environmentally friendly manner.

Warranty and Service

You receive a 3-year warranty for this device as of the purchase date. The appliance has been manufactured with care and meticulously examined before delivery.

During the warranty period our warranty covers, at our option, either the repair or the replacement of the appliance against an equivalent appliance. The wages, material costs and transport costs of the appliance incurred by us will be assumed by us. Please retain your receipt as proof of purchase.

Without a receipt, we cannot provide free warranty services. In the case of a warranty claim, please make contact by telephone with our Service Department.

The warranty covers only claims for material and manufacturing defects, but not for transport damage, improper set-up, wearing parts or for damage to fragile components, e.g. buttons or batteries. This product is for private use only and is not intended for commercial use.

The warranty is void in the case of abusive and improper handling, use of force and internal tampering not carried out by our authorized service branch. Your statutory rights are not restricted in any way by this warranty.

The warranty period is not extended by a repair made under warranty. This also applies to replaced and repaired parts. Damages and defects extant on purchase must be reported immediately after unpacking, at the latest by two days after the date of purchase. Repairs made after expiry of the warranty period will be subject to charge.

The warranty becomes void if the appliance has been opened, and/or modifications have been made to it, by you or by a third party not authorized by us.

The warranty does not cover any further liability on our part, in particular no liability for damages that are not from the appliance itself or caused by the failure of the appliance until it is repaired (e.g. transport costs, handling costs, etc.). Hereby, our statutory liabilities, in particular under product liability laws, are in no way limited or excluded.

Limitation of the warranty in regard to noise development: Noises generated by cooling and freezing equipments do not result in any warranty claims. This includes all of the sounds that may occur in normal operation.

Contact your Service Department in a case of malfunction. There, the next steps can be discussed.

Importer

KOMPERNASS GMBH
BURGSTRASSE 21
44867 BOCHUM, GERMANY

www.kompernass.com

DES UK LTD

Tel.: 0871 5000 700 (£ 0.10 / minute)

e-mail: support.uk@kompernass.com

Kompernass Service Ireland

Tel: 1850 930 412 (0,082 EUR/Min.)

Standard call rates apply. Mobile operators may vary.

e-mail: support.ie@kompernass.com

