

WINDOW TYPE ROOM AIR CONDITIONER OPERATION MANUAL

HW-07LM13

HW-07LM03

HW-09LM13

HW-09LM03

HW-12LM13

HW-12LM03

- Please read this operation manual before using the air conditioner.
- Please keep it attentively.

Contents

Contents	2
Part Name.....	3
Operation Guide	4-5
Maintenance	6-8
Trouble shooting	9
Installation Instructions.....	10
Installation Guide.....	11-12

The machine is adaptive in following situation:

1. Applicable ambient temperature range:

Cooling	Indoor	Maximum: D.B/W.B Minimum: D.B/W.B	32°C/23°C 18°C/14°C
	Outdoor	Maximum: D.B/W.B Minimum: D.B	43°C/26°C 18°C

2. If the supply cord is damaged, it must be replaced by the manufacturer or its serviceagent or a similar qualified person.
3. After installation, the power plug should be easily reached.
4. The wiring method should be in line with the local wiring standard.

Parts Name

Machine body

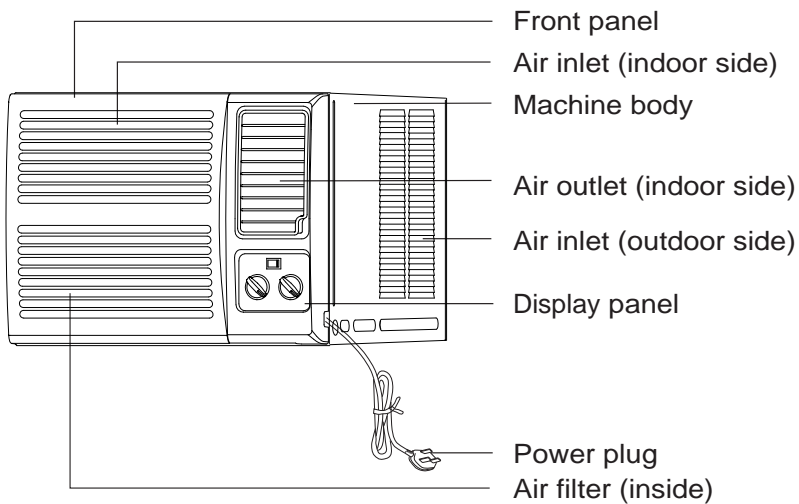

Operation panel

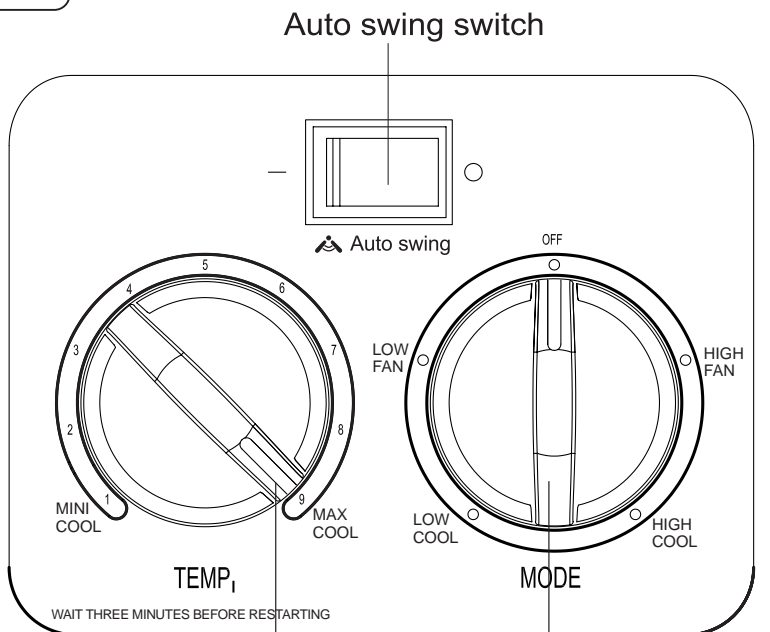

Thermostat switch

Mode selection switch

Operation Guide

● Auto swing switch

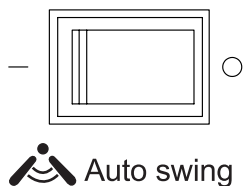

When the switch is set to "—", and vertical louvers will swing from side to side, delivering gentle air thus making you feel very comfortable. When it is set to "○", the indicator goes out, and the vertical louvers stop at any position.

● Mode selection switch

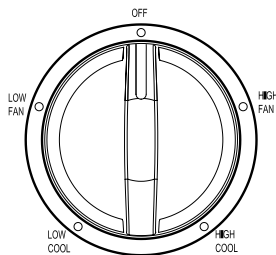

Mode selection switch controls the fan motor speed and cooling speed.

- <1> When set to "HIGH FAN", fan motor runs at high speed to blow out strong air.
- <2> When set to "LOW FAN", fan motor runs at low speed to blow out gentle air.
- <3> When set to "LOW COOL", air conditioner will start cooling at low speed, blowing out gentle air.
- <4> When set to "HIGH COOL", air conditioner will start speedy cooling, blowing out strong air.
- <5> When set to "OFF", air conditioner stops running.

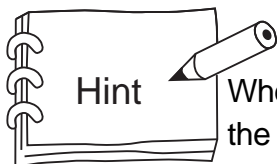

When the mode selection switch is turned to "HIGH FAN" or "LOW FAN", the air conditioner will only blow out air without cooling.

If the mode selection switch is turned from cooling mode to fan mode, do not turn it back until at least 3 minutes have elapsed.

Operation Guide

● Thermostat switch

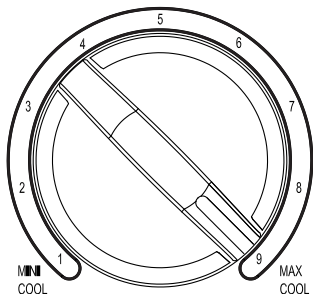

This switch controls the preset indoor temperature to make the air conditioner start or stop automatically, so as to reduce power consumption and operate the system both comfortably and economically.

Remark: The compressor stops running when the set temperature is reached but the fan continues to operate to keep an even indoor temperature.

Airflow Direction Vane

- The Vertical Airflow Direction Vane is manually controlled by positioning the vane to discharge the air upward, downward or straight out.
- The horizontal air direction is adjusted by setting the AUTO SWING switch to the ON position.

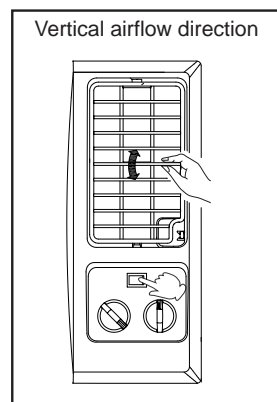

Note:

- It is advisable not to keep vertical flap at downward position for a long time in COOL or FAN mode, otherwise, condensate water might occur.
- Don't move the horizontal flap with hand in order to avoid the vertical flap abnormal, using the remote controller to adjust the move of vertical flap.



CAUTION

- In cooling mode, after you turn thermostat switch counter-clockwise, do not turn it back until at least 3 minutes have elapsed. Otherwise, the fuse may blow due to overload. Do not exceed the selection range.

Maintenance

Air filter cleaning (before cleaning, turn off the power)

When dirt accumulates on air filter, air circulation will be blocked, which causes poor cooling. It is advisable to clean air filter every two weeks for longer operation.

Take out the air filter

1. Press the concave parts on both sides at the lower part of air inlet grille to open the air inlet grille.
2. Hold the hump of filter mesh with fingers (as illustrated) and take it out.

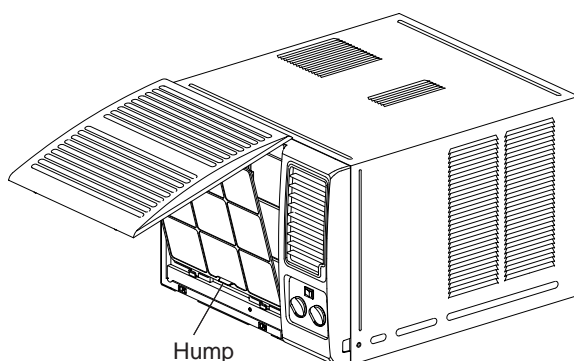

Air filter cleaning

1. Gently flap the dirt off the air filter.
2. Carefully wash air filter in warm water (below 40°C). To obtain better cleaning effect, soap water or neutral detergent may be used.
3. Flush air filter carefully with clean water after removing dirt. Let it dry completely.

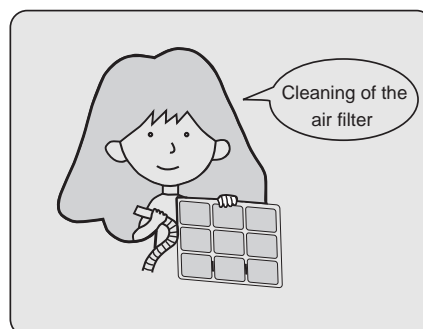

Maintenance

Disposal of the condensed water

Generally there are two methods available on disposal of the condensed water:

1. Block the bottom plate hole of the conditioner with rubber lid, install outlet pipe fitting on the back hole and let the condensing water flow from the back hole of the conditioner. (See Fig.1) In this method, the accumulated condensed water in the bottom plate is hit by the fan onto the heat exchanger, and evaporated and blown out from the machine. It can cool the heat exchanger radiator more quickly, and improve the energy efficiency of the conditioner. But the hitting noise by the fan at the outdoor side is relatively large.
2. Block the back hole of the conditioner with rubber lid and install outlet pipe fitting to the bottom hole, which can make the condensed water flow out from the bottom plate. (See Fig.2) If necessary the above two methods can both have extra pipe added on the outlet pipe fitting. (available on the market).

(Refer to P12 for choosing these two modes.)

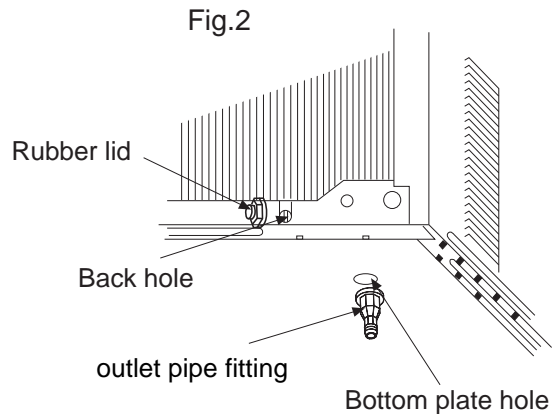
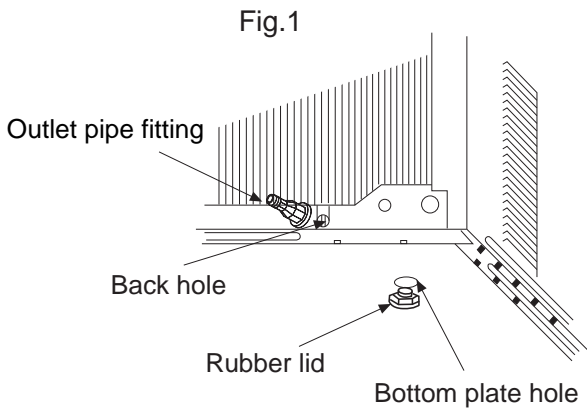

Cautions

- Power cord: Be sure to use the exclusive power cord.
- Change installation place: If air-con need to be changed to another place please contact the dealer, who sold you the unit.

Maintenance

- Avoid opening doors and windows unless necessary.

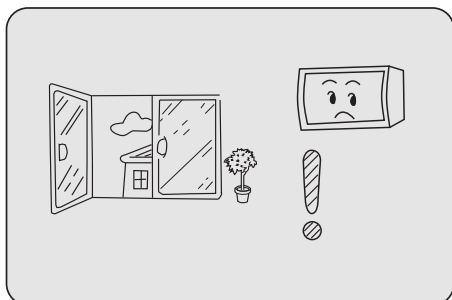

- Don't be exposed to cold air for a long time.



- Use curtain or blind
Direct sunlight may reduce cooling effect, always use window curtain.

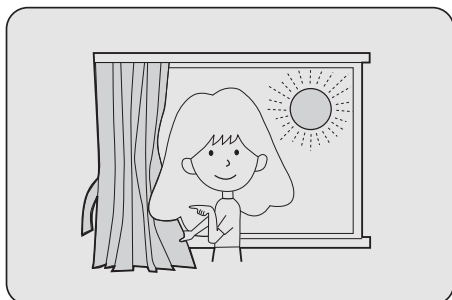

- Keep heat source away from air conditioner.

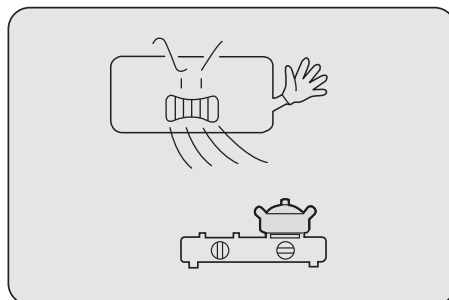

- Set temp . a little bit higher before going to bed.

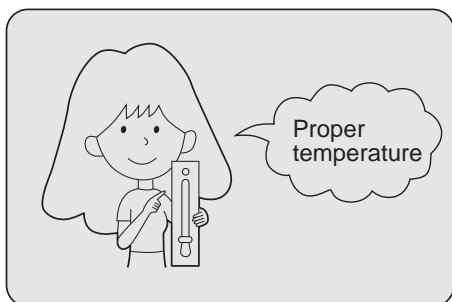

- After unit stops, don't restart it until 3 min. have elapsed.

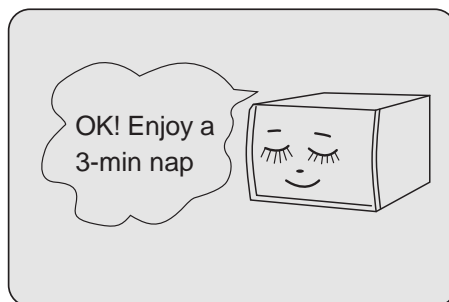

Troubleshooting

Doesn't work

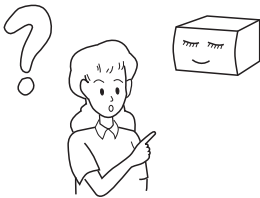

No cool air or poor cooling

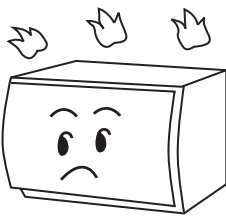

Is plug firmly inserted?
Is there power failure?

Readjust power supply.

Does fuse get burned?

Replace fuse.

Is thermostat switch
wrongly adjusted?

Readjust the thermostat.

Is there any direct
sunlight in the room?

Use curtain or blind.



Are doors or windows
left open?

Shut doors and windows.

Are there any obstacles
blocking air inlet and
outlet?

Remove the obstacles.

Is air filter clogged?

Clean it.



Is there too much heat
source in the room?

Remove the heat source

If problems can not be solved
please pull out power plug and
contact your dealer.

Installation Instructions

- Don't hang clothes in the vicinity of air inlet. This will decrease cooling effect and cause abnormal operation.

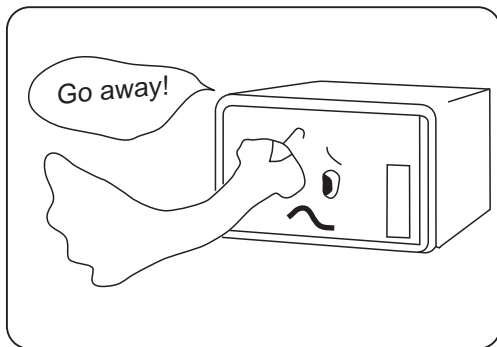

- Temperature should be set properly when there are infant, child, the aged or disabled in the room.

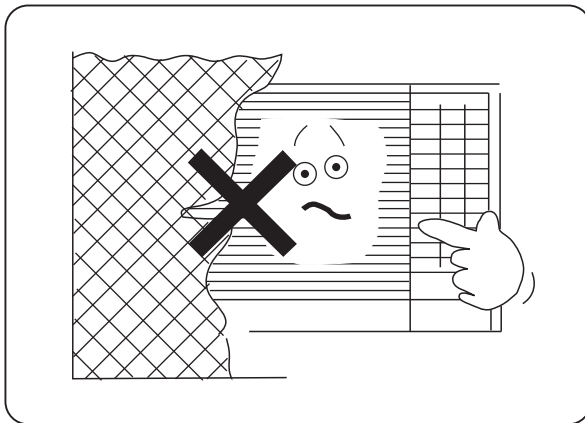
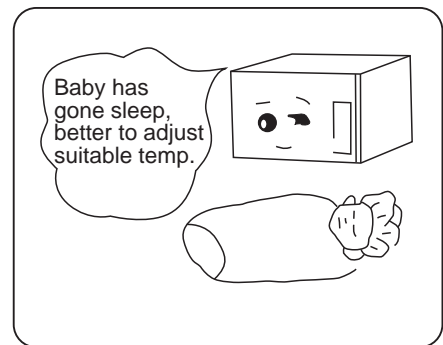

- Before operating mode selection switch, check that if the air inlet or outlet have been blocked.

For longer and trouble-free operation of the unit, pay special attention to the following:

- Install air-con at a place strong enough to support the unit.
- Leave enough space around air inlet and outlet for better circulation.
- Avoid places where flammable gas leaks.
- Problems may occur if unit is installed in the following places:
Place where oil exists in the air including engine oil or seaside with salt breeze blows and hot spring area with sulphurous gas in the air.

Installation Guide

Selection of the installation position

1. The air-conditioner is better installed in shadow or in a place with short period of sunshine. In case the air-conditioner is installed at the point exposed directly to the sunshine, it should be protected from the direct sunlight as possible in order to avoid the long time of direct sunlight otherwise its performance will be lowered. (As illustrated in Fig. 1).
2. For the convenience of operation, it is recommended that air-conditioner be installed at least at the height of 760-1300 mm above the floor and no obstacles before it for a free airflow.
3. The shutters at both sides and the top of air-conditioner should be protruded outdoors free from being blocked by wall, window, etc.
4. The back of air-conditioner should be kept over 500mm from the obstacles (for example, wall, etc.) (As illustrated in Fig. 2).
5. To have an efficient drainage, the back part of the air-conditioner should be inclined downward by 5-10mm (As illustrated in Fig. 3).

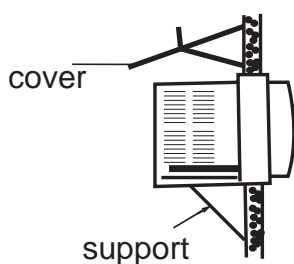

fig.1

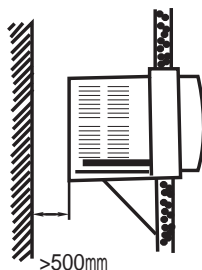

fig.2

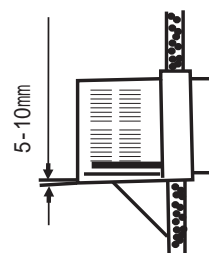



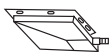



fig.3

The enclosed accessories of the conditioner are:

Name	Manual	Outlet pipe fitting	Sealed gasket	Drain pan	Screw
Figure					
Quantity	1	1	1	1	2

Installation Guide

Installation of air-conditioner (only for reference)

1. Make the wall hole or window hole (see Fig.1).
2. Fix the prefabricated iron frame to stable position by expansible screws.
3. Take out the conditioner and accessories from the package .
4. Cooling-only type air-conditioner: before dispatched from the factory, the drip hole at the bottom plate has been blocked by rubber lid in the accessories. If the surrounding humidity is high, should assemble drainage bend in the drainage hole at the back of bottom plate and connect the drainage tube as illustrated in Fig. 3. If the user doesn't need to retain the condensate in the bottom plate, can remove the rubber lid on the bottom and as illustrated in Fig. 2, assemble the attached drain pan on the bottom of the air-conditioner, and connect drainage tube at the water outlet hole on the drain pan.
5. If you need to lead the condensed water to indicated position, please purchase a piece of plastic pipe , set it on the outlet pipe fitting and tie it tightly.
6. After installation of all the accessories, put the whole machine on the iron frame. If there's water outlet flexible pipe, lead the pipe to needed position(see Fig.4).
7. Fill any distance between the wall hole and the machine body with flexible sponge rubber strip to prevent the entering of outer noise and the leaking of the coolness.
8. After installation of the conditioner, insert the power plug into the outlet and perform test-run.

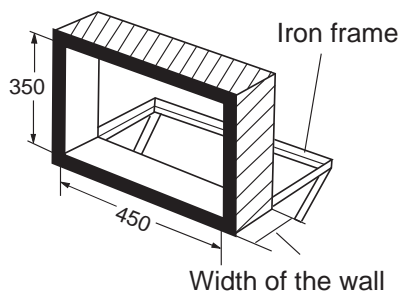

Fig. 1

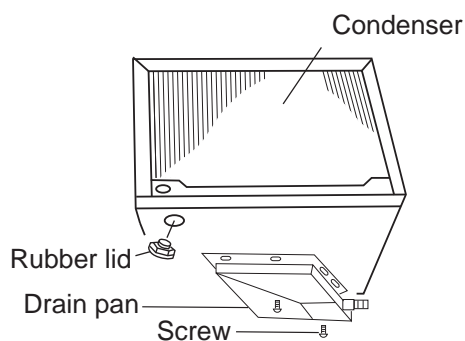

Fig. 2

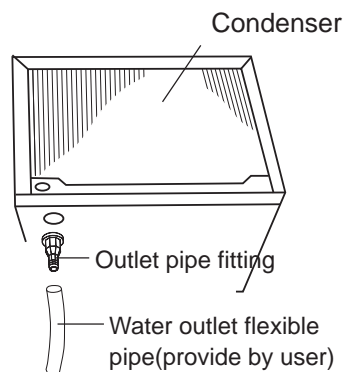

Fig.3

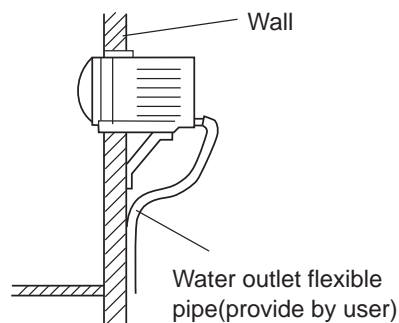

Fig.4