

# Operating Instructions Bedienungsanleitung Manuel d'instructions Bruksanvisning Manuale di istruzioni

Changer Control High-Power CD Player/RDS Receiver  
RDS CD-Tuner; High Power; CD-Wechslersteuerung  
Récepteur CD Pilote Changeur haute Puissance/Récepteur RDS  
Hög uteffekts CD/RDS radio med CD växlar styrning  
Sinto/lettore CD High Power con RDS/controllo per cambia CD

## CQ-DPG55LEN

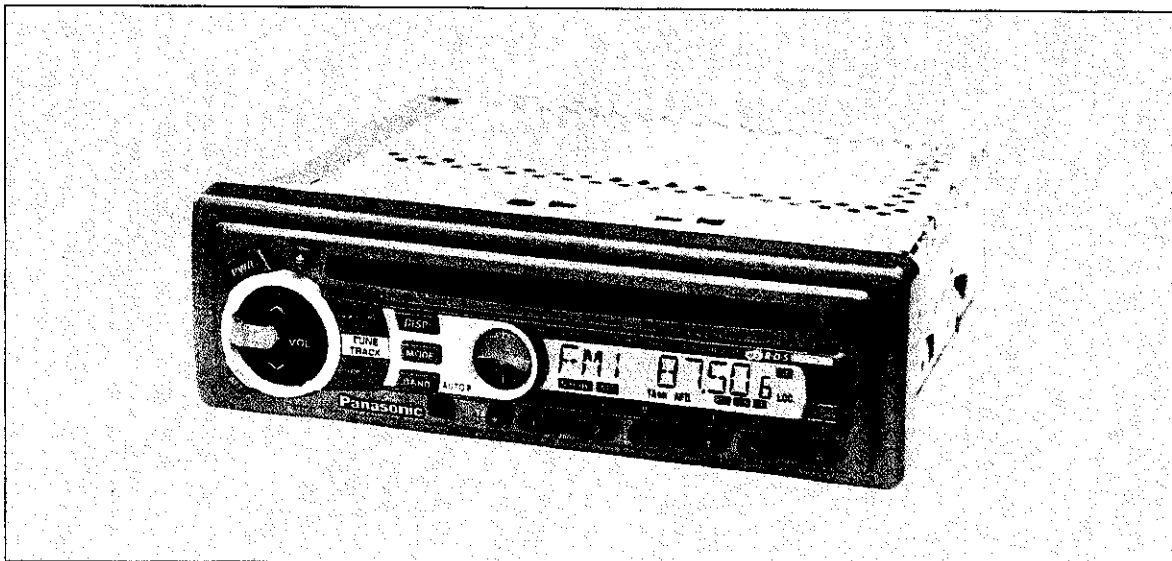

# Panasonic

Before operating this set, please read these instructions completely.  
Bitte lesen Sie diese Bedienungsanleitung vor der Inbetriebnahme aufmerksam durch.  
Nous vous recommandons de lire attentivement ces instructions avant d'utiliser cet appareil.  
Läs noga dessa anvisningar före apparatens användning.  
Prima di adoperare l'apparecchio, vogliate leggere attentamente le istruzioni.

# Contents

	Page		Page
Precautions (ISO Connector) .....	4	Installation .....	37
Power and Sound Controls .....	14	Electrical Connection .....	40
Radio Basics .....	16	Speaker Connections .....	41
RDS (Radio Data System) Reception .....	18	Special Notes .....	42
Compact Disc Player Basics .....	26	Fuse .....	43
CD Changer Basics .....	28	Maintenance .....	43
Remote Control Basics .....	30	Specifications .....	43
Anti-Theft System .....	34		

# Inhaltsverzeichnis

	Seite		Seite
ISO-Anschlußschema-Achtung :Sehr wichtig .....	6	Einbau .....	67
Stromversorgung und Klangregler .....	44	Elektrischer Anschluß .....	70
Rundfunkempfang .....	46	Anschluß der Lautsprecher .....	71
Radio-Data-System (RDS)-Empfang .....	48	Besondere Hinweise .....	72
Grundlagen für die Bedienung des CD-Spielers .....	56	Sicherung .....	73
Grundlagen für die Bedienung des CD-Wechslers ...	58	Pflege .....	73
Grundlagen für Fernbedienung .....	60	Technische Daten .....	73
Diebstahlschutz .....	64		

# Sommaire

	Page		Page
Précautions (Connecteur ISO) .....	8	Installation .....	97
Mise sous tension et commandes de son .....	74	Connexions électriques .....	100
Utilisation de la radio .....	76	Connexion des haut-parleurs .....	101
Réception avec le système RDS .....	78	Remarques spéciales .....	102
Utilisation de base du lecteur CD .....	86	Fusible .....	103
Utilisation de base du changeur de CD .....	88	Entretien .....	103
Utilisation de la télécommande .....	90	Spécifications .....	103
Système anti-vol .....	94		

# Innehåll

	Sida		Sida
Observera (ISO-kontakter) .....	10	Montering .....	127
Ström- och ljudreglage .....	104	Elektriska anslutningar .....	130
Grundläggande manövrering av radion .....	106	Anslutning av högtalare .....	131
RDS-mottagning (datastyrd radiomottagning) .....	108	Speciella anmärkningar .....	132
Grundläggande manövrering av CD-spelaren .....	116	Säkring .....	133
CD-spelarens grundläggande funktioner .....	118	Underhåll .....	133
Grundläggande tillvägagångssätt vid fjärrstyrning ..	120	Tekniska data .....	133
Stöldskyddsanordning .....	124		

# Contenuto

	Pag.		Pag.
Precauzioni (Connectore ISO).....	12	Installazione .....	157
Comandi di alimentazione e del suono.....	134	Collegamenti elettrici .....	160
Funzionamento della radio .....	136	Collegamento diffusori.....	161
Ricezione RDS (Radio Data System).....	138	Note speciali .....	162
Funzionamento del lettore CD.....	146	Fusibile .....	163
Operazioni fondamentali del cambiadischi CD ....	148	Manutenzione .....	163
Fondamenti del telecomando .....	150	Dati tecnici .....	163
Sistema antifurto .....	154		

- Label Indications and Their Locations
- Warnetiketten und deren Anbringungsort
- Indications portées les étiquettes et emplacement

- Varningsskyltarna, och deras placering
- Indicazioni delle etichette e le loro posizioni

- APPAREIL À LASER DE CLASSE 1
- KLASS 1 LASER APPARAT
- LUOKAN 1 LASERPLAITE

VORSICHT! UNSICHTBARE LASERSTRAHLUNG, WENN ABDECKUNG GEÖFFNET IST, NICHT DEM LASERSTRAHL AUSSETZEN.

A) ADVERSEL! Usynlig laserstråling når deksel åpnes og sikkerhedslås brytes. Unngå eksponering for strålen.

B) VARNING! Osynlig laserstråling när denna del är öppnad och spärren är urkopplad. Betrakta ej strålen.

C) VARO! Avattaessa ja suojalukitus ohitettaessa olet alitiina näkymättömälle lasersäteilylle. Älä katso säteeseen.

CLASS 1  
LASER PRODUCT

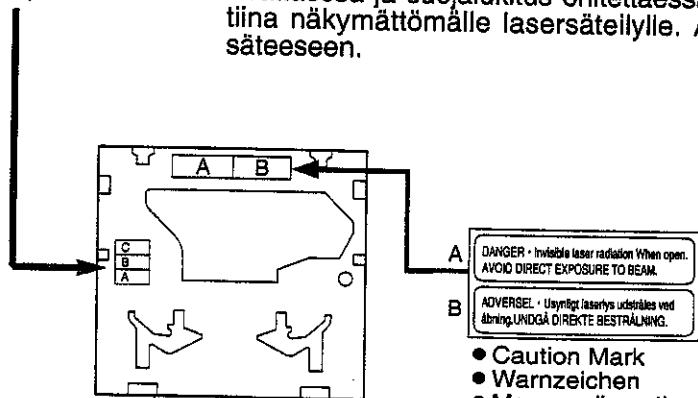
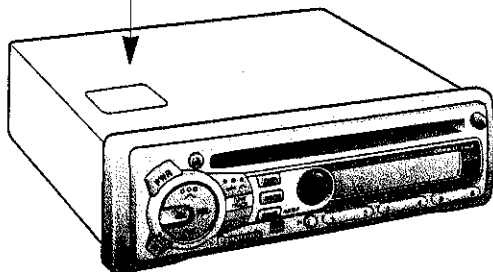

- Caution Mark
- Warnzeichen
- Marque d'avertissement
- Varningsmärke
- Marca di precauzione

- Deck Ass'y (Upper Side)
- Geräteansicht (Oberseite)
- Assemblage de la table lecture (Côté supérieur)
- Däcksenhet (Topp)
- Gruppo della piastra (Lato superiore)

# Precautions (ISO connector)

- Wiring for the power connector conforms to the arrangement of standard ISO connectors.
- In case of some car types, the arrangement of connector may differ from the standard ISO as shown in Table 1, even though ISO connectors are adopted.

Table 1

Fig. 1 Pin No.	A4	A7
Car for standard ISO	Battery (permanent 12 V supply)	"IGN" or "ACC" (switched 12 V supply)
In case of Car type A	"IGN" or "ACC" (switched 12 V supply)	Battery (permanent 12 V supply)
In case of Car type B	No Connection	Battery (permanent 12 V supply)

- Make sure the ISO connector arrangement in your car side is as same as the standard ISO. (Table 1, Fig. 1)
- In case of arrangement for Car type A or B, change connections of the red/yellow leads at the re-connectable joint (※) as shown in Fig.1.

Fig.1

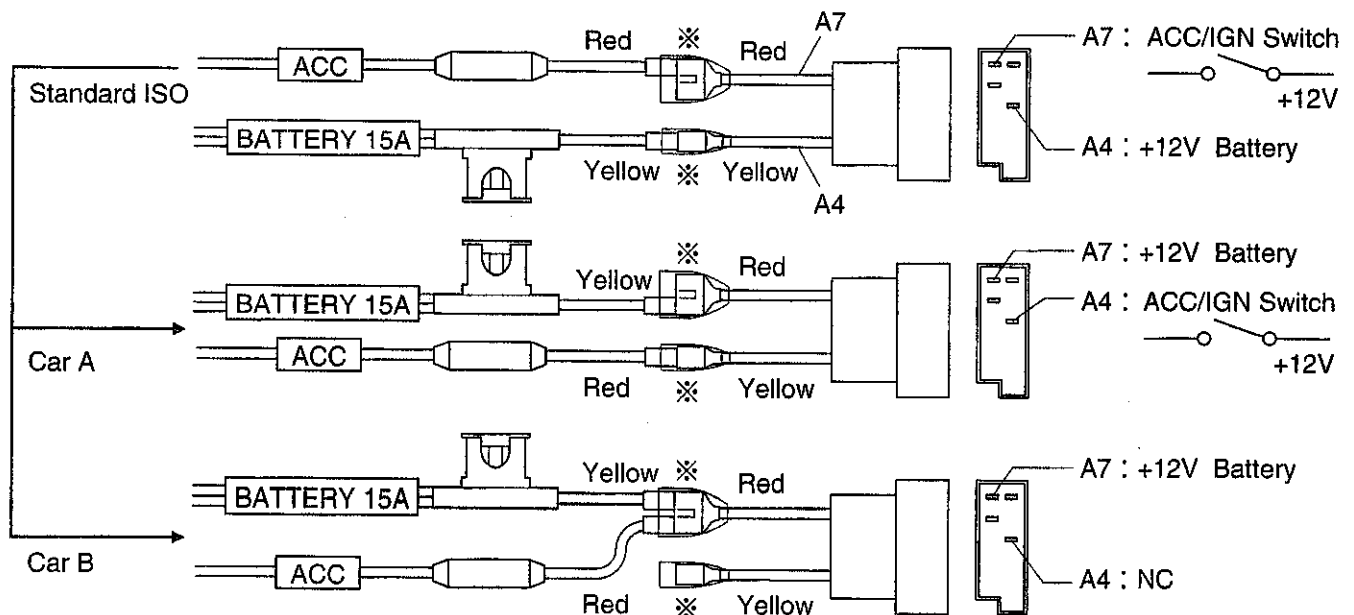

- After fix the connections, the part (※) should be insulated with electrical tape to keep away from unit damage.

**Panasonic** welcomes you to their constantly growing family of electronic products owners. We endeavor to give you the advantages of precise electronic and mechanical engineering, manufactured with carefully selected components, and assembled by people who are proud of the reputation their work has built for our company. We know this product will bring you many hours of enjoyment, and after you discover the quality, value, and reliability we have built into it, you too will be proud to be a member of our family.

## Precautions

### Volume Level

For your driving safety, keep the volume level low enough to be aware of road and traffic conditions.

### Car Washing

To avoid electrical shorts which may cause fire, or other damage, do not expose this equipment (including the speakers and CDs) to water or excessive moisture.

### Car Ventilation

If your car is parked for several hours in direct sunlight, the temperature inside the car may become very high. It is advisable to drive the car and give the interior a chance to cool down before switching the unit on.

### Power Supply

This equipment is designed to be used in a car having 12-Volt negative ground battery system.

### Disc Mechanism

Do not insert coins or any small objects. Keep screwdrivers and other metallic objects away from the disc mechanism and disc.

### Service

This unit is made of precision parts. Do not attempt to disassemble or adjust any parts. For repair, please consult your nearest authorized Panasonic Service Center.

### Note:

The preset memory is cleared to return to the original factory setting when the power connector or battery is disconnected.

## Laser Products

### Caution:

This product utilizes a laser. Use of controls or adjustments or performance of procedures other than those specified herein may result in hazardous radiation exposure.

### Laser products:

Wave Length 780 nm  
Laser Power No hazardous radiation is emitted with safety protection.

### Do not take apart this unit or attempt to make any changes yourself.

This unit is a very intricate device that uses a laser pickup to retrieve information from the surface of compact discs. The laser is carefully shielded so that its rays remain inside the cabinet. Therefore, never try to disassemble the player or alter any of its parts since you may be exposed to laser rays and dangerous voltages.

# ISO-Anschlußschema-Achtung: Sehr wichtig

- Die Verdrahtung des mitgelieferten Stromkabels entspricht der Anordnung der normalen ISO-Steckverbinder.
- Bei einigen Autotypen kann es vorkommen, daß die Verdrahtung anders als die aus der Tabelle 1 ersichtlichen ISO-Anordnung ist, obwohl ISO-Steckverbinder verwendet werden.

Tabelle 1

Abb. 1, Stift Nr.	A4	A7
Auto für normale ISO-Anordnung	Batterie (ständige 12V-Stromversorgung)	"IGN" oder "ACC" (umgeschaltete 12V-Stromversorgung)
Beispiel Auto A	"IGN" oder "ACC" (umgeschaltete 12V-Stromversorgung)	Batterie (ständige 12V-Stromversorgung)
Beispiel Auto B	Kein Anschluß	Batterie (ständige 12V-Stromversorgung)

- Die Daten überprüfen, um sicherzustellen, daß die Anordnung der ISO-Steckverbinder auf der Autoseite die gleiche ist wie die normale ISO-Anordnung (Tabelle 1, Abb. 1).
- Im Falle der Anordnung für Auto A oder B die Anschlüsse der rot/gelben Kabel am Übertragungs-Steckverbinderblock (※) gemäß Abb. 1 ändern.



Abb. 1

- Nach der Verkabelung sollte unbedingt der durch ※ gekennzeichnete Teil mit Hilfe von Isolierbändern o.ä. isoliert werden.

### **Lieber Panasonic-Kunde**

Wir möchten Ihnen dafür danken, daß Sie sich für dieses Gerät entschieden haben. Wir heißen Sie hiermit herzlich willkommen in der ständig wachsenden Familie zufriedener Besitzer von Panasonic-Geräten in der ganzen Welt. Wir sind sicher, daß mit dieser Neuerwerbung alle ihre Ansprüche befriedigt werden. Lesen Sie bitte diese Bedienungsanleitung sorgfältig durch, und halten Sie sie immer griffbereit. Denn sie enthält eine Anzahl wichtiger Hinweise, die gewährleisten, daß Sie die Möglichkeiten ihres Gerätes voll ausnutzen können.

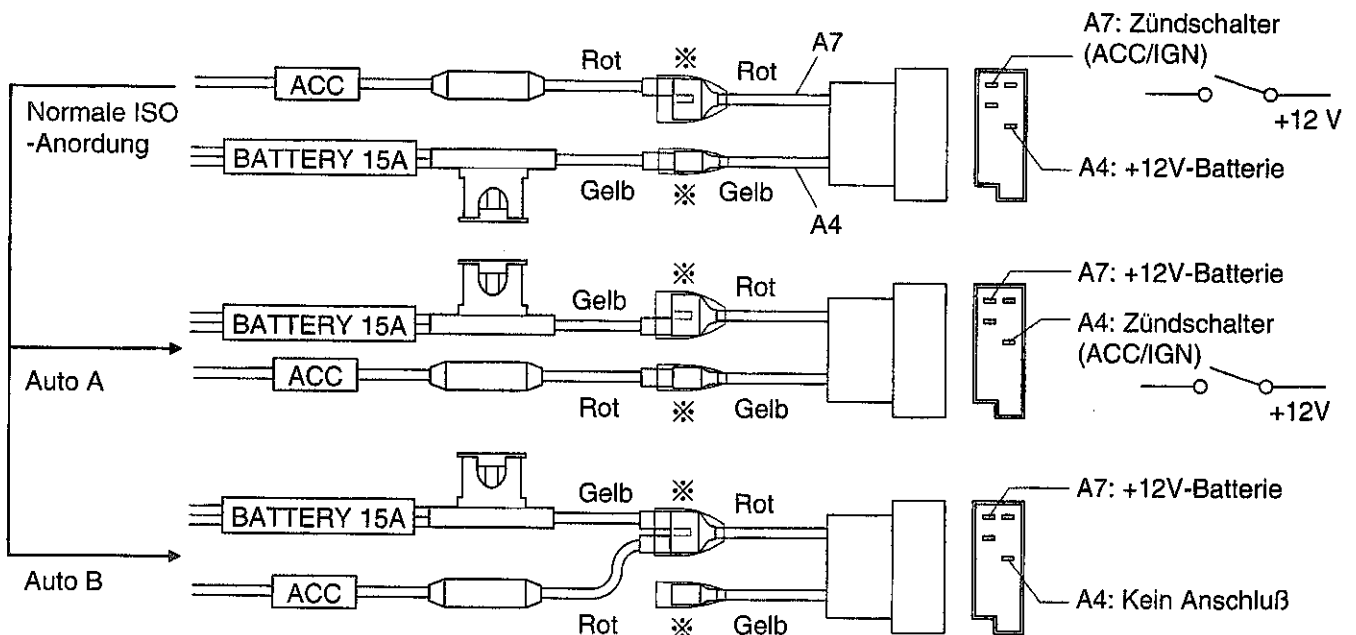
## **Vorsichtsmaßnahmen**

### **Lautstärkepegel**

Aus Gründen der Fahrsicherheit ist der Lautstärkepegel so einzustellen, daß auch andere Verkehrsgeräusche (Hupen, Warnsignale) vernommen werden können.

### **Autowäsche**

Dieses Gerät (einschließlich Lautsprecher und CD) vor Wasser und übermäßiger Feuchtigkeit schützen, um elektrischen Kurzschlüssen vorzubeugen.

### **Belüftung**

Falls Ihr Wagen längere Zeit in direktem Sonnenlicht geparkt ist, könnte sich das Innere sehr stark erwärmen. In einem solchen Fall sollte das Fahrzeug mit geöffneten Fenstern für einige Zeit gefahren werden, damit sich das Wageninnere abkühlen kann. Erst danach das Gerät einschalten.

### **Stromversorgung**

Dieses Gerät darf nur in Fahrzeuge mit 12 V-Batterie und negativer Batterieklemme an Masse eingebaut werden.

### **CD-Laufwerk**

Keine Münzen oder kleine Gegenstände in das Gerät einstecken. Schraubenzieher und andere metallische Gegenstände vom CD-Laufwerk und den CDs fernhalten.

### **Kundendienst**

Dieses Gerät ist aus Präzisionsteilen zusammengestellt. Niemals selbst das Gerät zerlegen bzw. einzelne Teile einstellen. Für Reparaturen wenden Sie sich bitte an den Panasonic Kundendienst.

### **Hinweis:**

Beim Trennen des Versorgungssteckers oder der Batterie wird der Voreinstellungsspeicher gelöscht und die ursprüngliche Werkseinstellung wird wieder aktiv.

## **Laser Erzeugnisse**

### **Vorsicht:**

**Dieses Gerät arbeitet mit Laserstrahlen. Benutzung der Bedienungselemente anders als in der Bedienungsanleitung beschrieben oder Veränderungen der Betriebsweise können zu gefährlicher Strahlenaussetzung führen.**

### **Laser-Erzeugnisse:**

Wellenlänge 780 nm

Laser Energie Mit Sicherheitsschutz entweicht keine gefährliche Strahlung.

**Öffnen Sie dieses Gerät nicht, und versuchen Sie unter keinen Umständen, am Gerät herumzubasteln.**

Dieses Gerät ist ein sehr kompliziertes Instrument, das einen Laserstrahl benutzt, um die auf der Oberfläche der CDs gespeicherten Informationen abzulesen. Der Laserstrahl ist sorgfältig abgeschirmt, so daß die Strahlung innerhalb des Gerätes verbleibt.

Aus diesem Grunde öffnen Sie das Gerät auf keinen Fall, und versuchen Sie unter keinen Umständen Geräteteile zu verändern. Sie können sich unter Umständen gefährlicher Strahlung und Stromspannung aussetzen.

# Précautions (Connecteur ISO)

- Le câblage pour le cordon d'alimentation prévu en accessoire se conforme à l'alignement des connecteurs standard ISO.
- Pour certains types de véhicules, une partie de câblage peut différer de l'alignement standard ISO comme l'indique le Tableau 1, même si les connecteurs ISO sont adoptés.

Tableau 1

N° de broche sur la Fig. 1	A4	A7
Véhicule pour l'alignement standard ISO	Batterie (alimentation permanente en 12 V)	"IGN" ou "ACC" (alimentation en 12 V sélectionnée)
Exemple de véhicule A	"IGN" ou "ACC" (alimentation en 12 V sélectionnée)	Batterie (alimentation permanente en 12 V)
Exemple de véhicule B	Absence de connexion	Batterie (alimentation permanente en 12 V)

- Vérifier les données pour s'assurer que l'alignement de connecteur ISO du côté véhicule est identique à celui standard ISO (Tableau 1, Fig. 1).
- En cas d'alignement pour le véhicule A ou B, changer les connexions des conducteurs rouges/jaunes au bloc connecteur de transfert (※) comme le montre la Fig. 1.

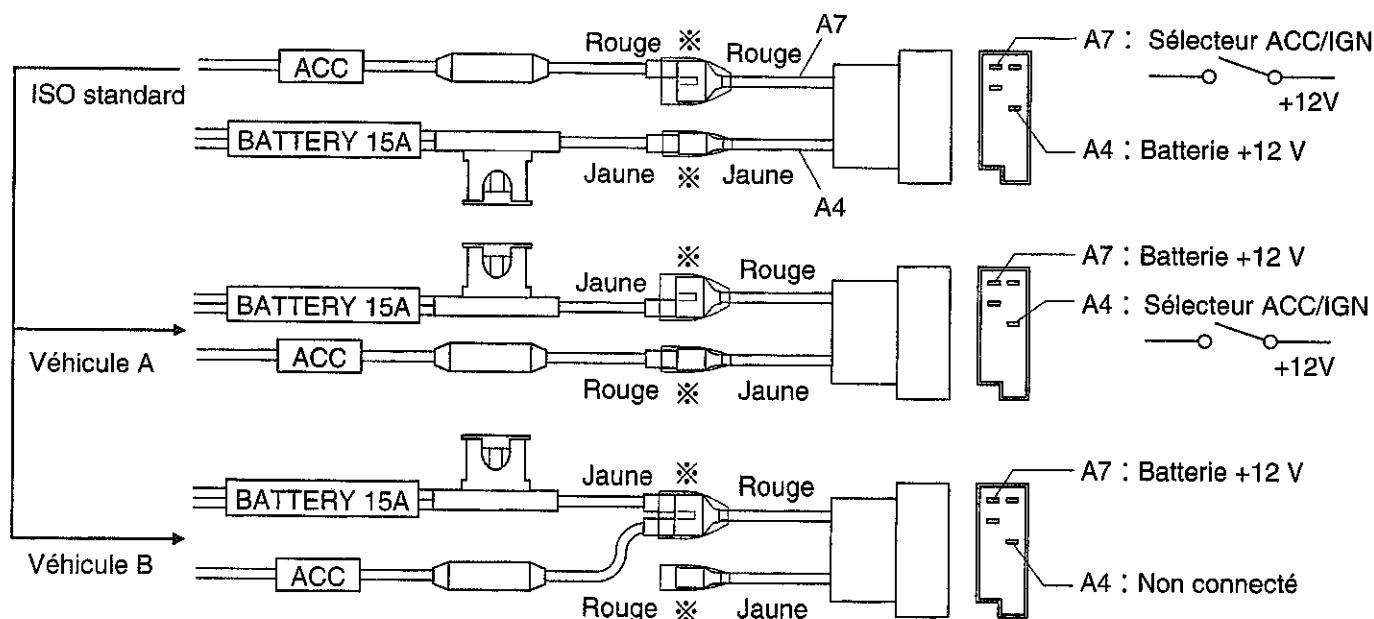

Fig.1

- Après les opérations, les parties marquées par un astérisque (※) doivent être isolées sans faute en utilisant des rubans isolants ou des matériaux similaires.



**Panasonic** vous souhaite la bienvenue parmi la famille toujours croissante des possesseurs de nos appareils électroniques. Nous avons fait de notre mieux pour vous apporter les avantages de la précision mécanique et électronique de pointe, étant donné que l'appareil a été composé avec des pièces soigneusement choisies et montées par des gens qui sont fiers de la renommée de leur Société que leur travail consciencieux lui a valu. Nous sommes sûrs que cet appareil vous permettra de profiter de nombreuses heures d'écoute, et après avoir découvert la qualité intrinsèque et la fiabilité de l'appareil, vous serez vous aussi fier d'appartenir à la famille **Panasonic**.

## Précautions

### Niveau du volume

Par mesure de sécurité routière, maintenez le niveau de volume assez bas pour pouvoir entendre les bruits de la rue.

### Nettoyage de la voiture

Pour éviter les court-circuits électriques qui peuvent provoquer un incendie ou autre dommage, n'exposez pas l'appareil (y compris les hautparleurs, les CDs) à l'eau ou à une humidité excessive.

### Ventilation de la voiture

Si votre véhicule est stationné pendant plusieurs heures au soleil, la température intérieure peut être très élevée. Pour revenir au mode de température normal, il est recommandé de conduire un certain temps avant de mettre l'appareil sous tension.

### Alimentation

Cet équipement est conçu pour fonctionner avec du 12 V cc, masse négative.

### Mécanisme d'entraînement du disque

Ne pas introduire de pièce de monnaie ou tout autre petit objet. Eloigner les aimants, tournevis et autres objets métalliques du mécanisme d'entraînement et du disque.

### Entretien

Cet appareil est conçu à partir d'éléments de précision. N'essayez pas de démonter ces éléments. Pour l'entretien, adressez-vous à votre service d'entretien Panasonic le plus proche.

### Remarque:

Les présélections mémorisées sont effacées pour revenir aux sélections initiales en usine lorsque le connecteur d'alimentation ou la batterie est débranché.

## Caractéristiques du dispositif laser

### Attention:

**Ce produit utilise un laser.**

L'utilisation des commandes, le réglage ou le fonctionnement, suivant les procédures différentes de celles exposées ci-dessus peuvent entraîner une exposition dangereuse aux radiations.

### Caractéristiques du dispositif laser:

Longueur d'onde 780 nm

Puissance Aucune radiation nocive n'est émise avec protection de sécurité.

### Ne pas démonter cet appareil ni y apporter de modifications vous-même.

Cet appareil est un dispositif très complexe utilisant une tête de lecture laser pour extraire des informations de la surface des disques compacts.

Le laser est soigneusement protégé de telle manière que le faisceau laser reste à l'intérieur du coffret.

Par conséquent, ne jamais essayer de démonter le lecteur ni modifier une de ses parties étant donné que vous pourriez ainsi être exposé au faisceau laser et à des tensions dangereuses.

# Observera (ISO-kontakter)

- Kontrollera att kablarna för tändningens strömkabel är korrekt utformade för anpassning till standard ISO-kontakter.
- I en del typer av bilar kan det hända att vissa kablar skiljer sig från anpassningen till standard ISO-kontakter på det sätt som framgår av tabell 1, även om ISO-kontakter används.

Tabell 1

Ill. 1, pol nr.	A4	A7
Bil för anpassning till standard ISO-kontakt	Batteri (ständig, 12 V strömförsörjning)	Tändning (omkopplad, 12 V strömförsörjning)
Exempel på bil A	Tändning (omkopplad, 12 V strömförsörjning)	Batteri (ständig, 12 V strömförsörjning)
Exempel på bil B	Ingen anslutning	Batteri (ständig, 12 V strömförsörjning)

- Kontrollera data för att bekräfta att anpassningen till ISO-kontakter på bilens kablar överensstämmer med anpassningen till standard ISO-kontakter (tabell 1/ill. 1).
- Ändra den röda och den gula kabelns anslutningar till överföringskontakten (※) såsom visas på ill. 1, när anpassning för bil A eller bil B gäller.

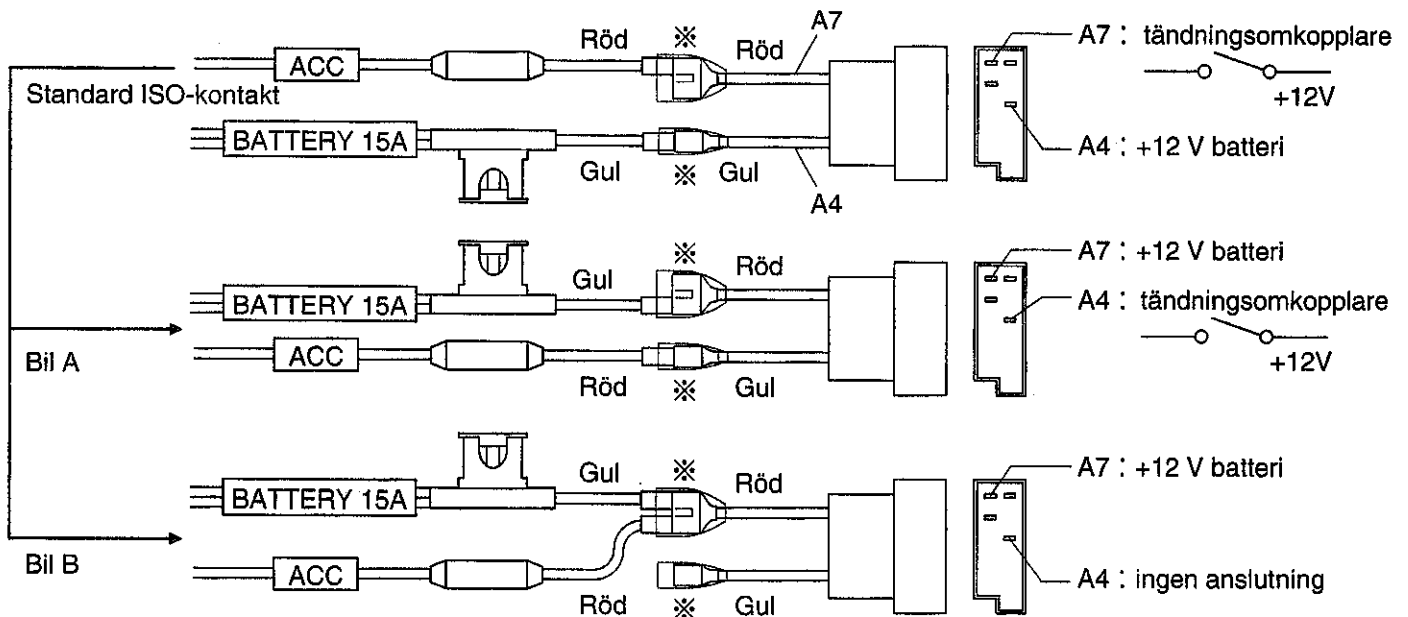

III. 1

- Kontakterna märkta ※ måste alltid isoleras med hjälp av isoleringstejp eller liknande, efter slutförda anslutningar.

Välkommen till den ständigt växande gruppen av ägare till **Panasonic** elektroniska produkter. Varje produkt tillverkas av noggrant utvalda komponenter och sammansätts av välutbildad personal under sträng kvalitetskontroll.

Läs bruksanvisningen noga och lär apparaten väl innan den används.

## Observera

### Volym

Anpassa ljudvolymen så att säker bilkörning ej hindras.

### Biltvättning

För att undvika kortslutningar som kan resultera i brand eller annan skada, får apparaten (inklusive högtalarna och skivorna) inte utsättas för vatten eller fukt.

### Ventilation inom bilen

Är det mycket varmt i bilen, kör den då en stund för att sänka temperaturen innan apparaten kopplas på.

### Strömförsörjning

Apparaten får enbart anslutas till ett fordon vars elektriska system är 12 V likspänning och negativ jordning.

### Skyvmekanism

Stoppa inte in mynt eller andra småföremål. Håll, skruvmejslar och andra metallföremål borta från skyvmekanismen och skivor.

### Service

Apparaten är tillverkad av precisionsdelar. Tag aldrig isär eller justera någonting själv. För reparation, lämna apparaten till en Panasonic-återförsäljare.

### Anm:

Observera att samtliga uppgifter, som lagrats i minnet, återgår till de inställningar som gjordes före bilstereons leverans från fabriken när strömkabeln eller batterikabeln kopplas ur.

## Om laserprodukter

### Att observera:

**En laserstråle används i denna produkt.**

Användandet av reglage och utförandet av justeringar/tillvägagångssätt, som inte beskrivs i denna bruksanvisning, kan bli orsak till farlig strålning.

### Laserstrålens egenskaper:

Våglängd 780 nm

Lasereffekt Ingen farlig strålning avges med skyddssäkringarna intakta.

### Denna apparat får inte plockas isär och Inga ändringar får utföras av konsumenten.

Denna apparat är en mycket komplicerad anordning som nyttjar en laserstråle för upptagning av informationen från CD-skivans yta. Lasern är noggrant avskärmd så att dess strålar förblir innanför apparathöljet. Därför får CD-spelaren inte tagas isär eller någon av dess delar ändras eftersom du kan utsättas för laserstrålen och hög spänning.

**VARNING!** Om apparaten används på annat sätt än i denna bruksanvisning specificerats, kan användaren utsättas för osynlig laserstrålning, som överskrider gränsen för laserklass 1.

**VAROITUS!** Laitteen käyttäminen muulla kuin tässä käyttöohjeessa mainitulla tavalla saattaa altistaa käyttäjän turvallisuusluokan I ylittävälle näkymättömälle lasersäteilylle.

# Precauzioni (Connettore ISO)

- Il cablaggio per il cavo di alimentazione accessoria è conforme all'allineamento dei collegamenti ISO standard.
- Per alcuni tipi di auto, parti del cablaggio possono differire dall'allineamento ISO standard mostrato nella tabella 1, anche se sono impiegati connettori ISO.

**Tabella 1**

N. terminale in Fig. 1	A4	A7
Auto per allineamento ISO standard	Batteria (12 V forniti continuamente)	"IGN" o "ACC" (12 V forniti a commutazione)
Esempio di auto A	"IGN" o "ACC" (12 V forniti a commutazione)	Batteria (12 V forniti continuamente)
Esempio di auto B	Nessun collegamento	Batteria (12 V forniti continuamente)

- Controllare i dati per verificare che l'allineamento connettori ISO sul lato dell'auto sia uguale all'allineamento ISO standard (Tabella 1, Fig. 1).
- Nel caso dell'allineamento per auto A o B, cambiare il collegamento dei cavi rosso/giallo al blocco connettore di trasferimento (※) come mostrato nella Fig. 1.

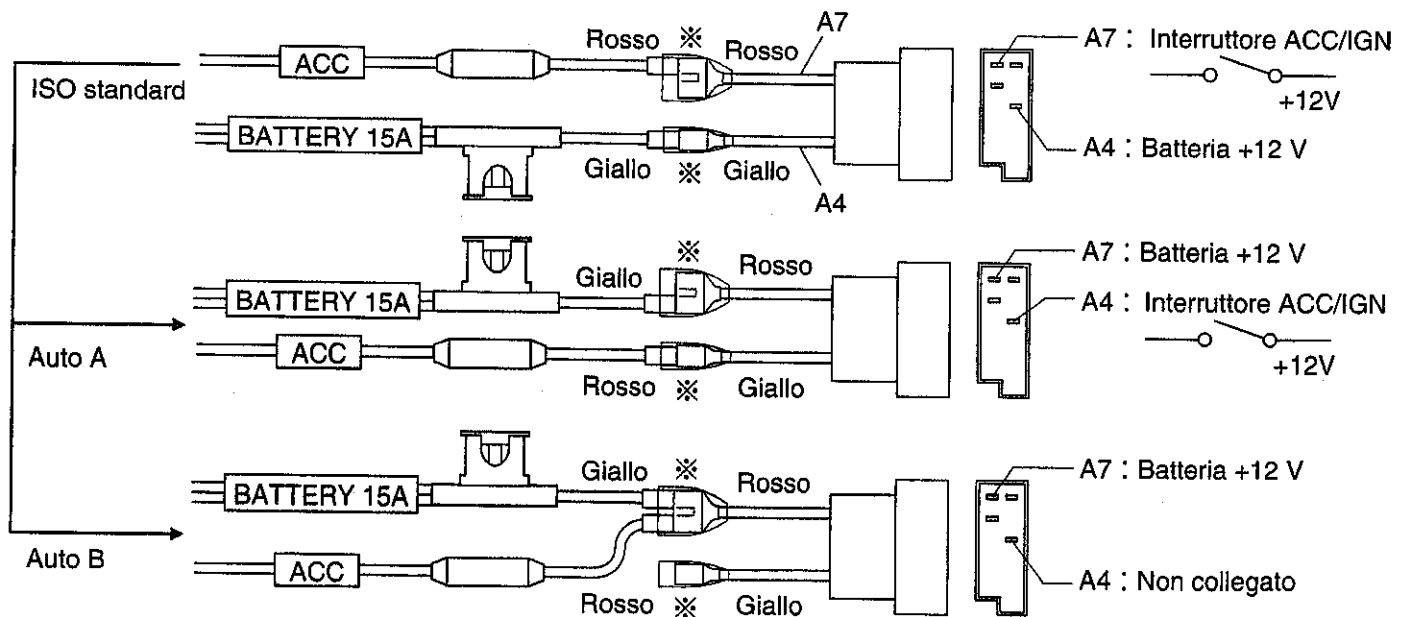

**Fig. 1**

- Dopo l'operazione la parte indicata da ※ deve essere assolutamente isolata, usando nastro isolante o simili.

**Panasonic** Vi dà il benvenuto nella famiglia in costante aumento dei proprietari dei suoi prodotti elettronici. Noi cerchiamo sempre di offrirvi i vantaggi di una tecnica elettronica e di una meccanica perfetta nei nostri prodotti fabbricati con componenti altamente selezionati e lavorati da persone che godono di piena fiducia presso la nostra compagnia. Noi siamo sicuri che questo prodotto Vi offrirà molte ore piacevoli e che dopo averne scoperto la qualità, il valore e l'affidabilità, anche Voi sarete orgogliosi di essere un membro della nostra famiglia.

## Precauzioni

### Livello del volume

Per la vostra sicurezza quando portate l'automobile, tenete il volume su un livello abbastanza basso per poter sentire il suono di avvertimento del traffico.

### Lavaggio dell'automobile

Per evitare cortocircuiti elettrici, che potrebbero causare incendi o altri danni, non esponete quest'unità (inclusi gli altoparlanti, i dischi) all'acqua o ad eccessive quantità di umidità.

### Ventilazione dell'automobile

Nel caso in cui lasciate l'automobile parcheggiata per parecchie ore nella luce diretta del sole, la temperatura all'interno dell'automobile può diventare molto alta. Per far ritornare la temperatura interna ad un livello normale, è consigliabile guidare l'automobile un po' di tempo prima di accendere l'unità.

### Alimentazione

Quest'unità è stata disegnata per essere alimentata con 12 V di corrente continua, massa negativa.

### Meccanismo dei dischi

Non inserire delle monete o altri oggetti piccoli. Allontanare i cacciaviti ed altri oggetti metallici dal meccanismo dei dischi e dai dischi.

### Servizio

Quest'unità è stata costruita con parti di precisione. Non cercate di smontare o aggiustare queste parti. Per i lavori di servizio, consultate il più vicino centro assistenza della Panasonic.

### Nota:

Quando si stacca il cablaggio o la batteria, la memoria di preselezione si cancella e torna la regolazione operata in fabbrica.

## Prodotti laser

### Precauzione:

**Questo prodotto utilizza un laser.**

L'impiego dei comandi o regolazioni, o una esecuzione dei procedimenti diversi da quelli specificati in questo manuale possono risultare in una esposizione pericolosa a radiazioni.

### Prodotti laser:

Lunghezza d'onda 780 nm

Potenza dei laser Nessuna radiazione pericolosa viene emessa con una protezione di sicurezza.

### Non smontare quest'unità o tentare di eseguire dei cambiamenti da solo.

Quest'unità è un apparecchio con pezzi di precisione che usa un pick-up con laser per ricevere dati dalla superficie dei compact disc. Il laser viene protetto con cura di modo che rimanga all'interno del mobiletto. Si raccomanda quindi di non smontare la piastra o eseguire delle modificazioni con i suoi componenti poiché procedendo così si può esporsi al raggio del laser ed alle tensioni pericolose.

# Power and Sound Controls

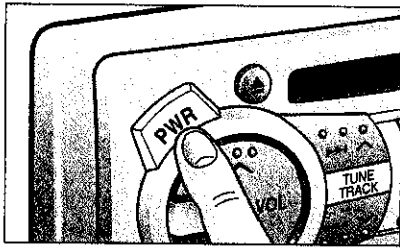
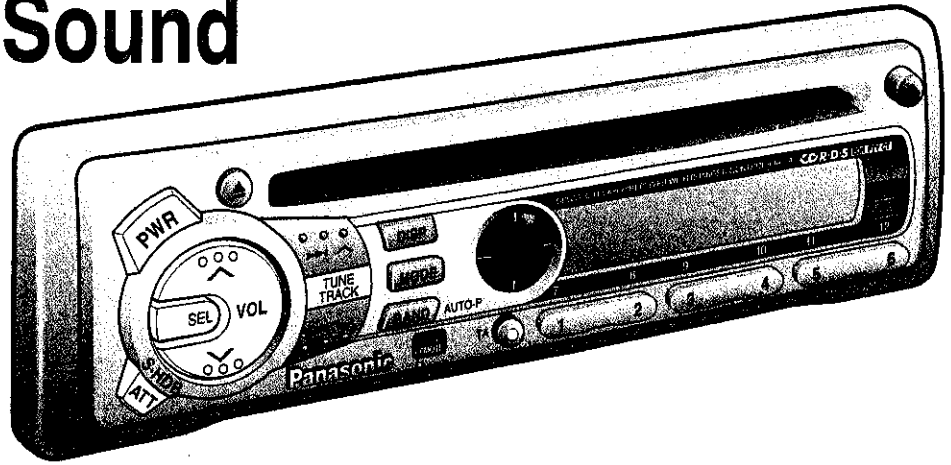

## Power

If the car is not already running, turn the key in the ignition until the accessory indicator lights.

Press PWR to switch on the power.

Press and hold PWR again to switch off the power.

**Note:** When power is switched on for the first time, demonstration display appears. To release this display, press DISP.

FM 87.50

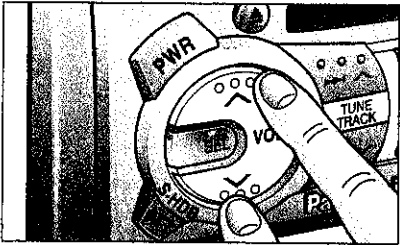

## Volume

Press "VOL ^" or "VOL v" to increase or decrease volume.

VOL 40 ——— Volume Level

0 to 40

Press "VOL ^" or "VOL v" for more than a half second to sequentially change numeric levels on the display.

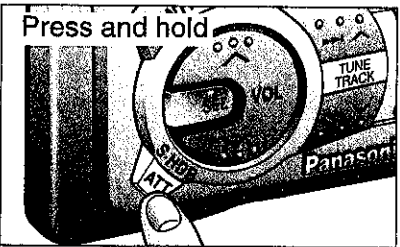

## S•HDB (Super High Definition Bass)

Especially for rock music, the bass-sound will be more powerful.

- Press and hold ATT for more than 2 seconds to be able to listen to high-definition bass.

S•HDB

- Press and hold ATT for more than 2 seconds again to cancel.

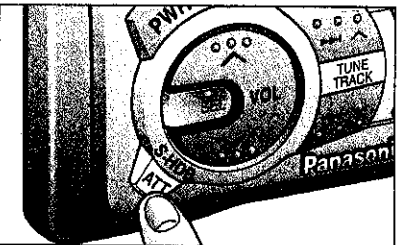

## Attenuator

- Press ATT to decrease volume to about 1/10 of the previous level.

ATT

- Press ATT again to cancel.

**Note:** This unit is equipped with anti-volume-blast circuit which serves as an automatic volume level adjuster so that you will not be deafened with sudden loud volume.

This system operates as below. When PWR is first pressed to switch on, the volume level is low. After that, the volume level gradually returns to the level when the switch is turned off.

Anti-volume-blast circuit is not effective when volume level is lower than position 20 at the display.



# Radio Basics

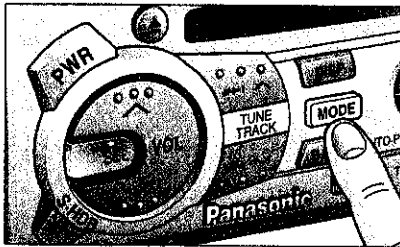
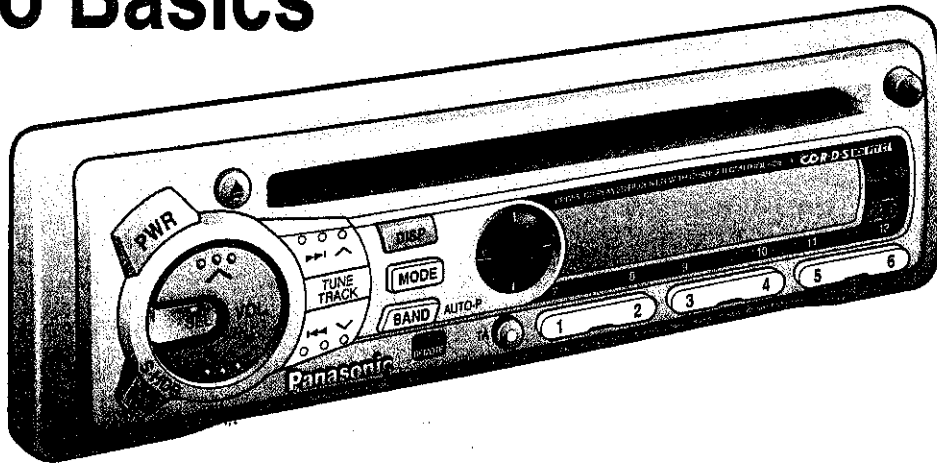

## To change Tuner Mode

Press MODE to switch the operation mode in the following order.

Tuner → CD Player → (CD Changer Control)

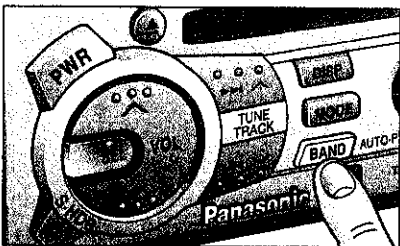
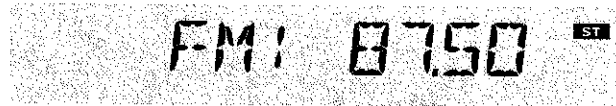
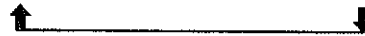

## Selecting a Band

Press BAND to select the bands in the following order.  
"ST" indicator lights if the station is broadcasting in stereo.

FM1 → FM2 → FM3 → AM(LW/MW)

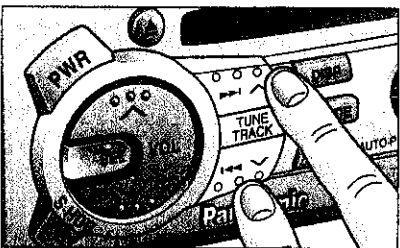

## Manual Tuning

Press "∨ TUNE" or "TUNE ∧" to move to a lower or higher frequency.



Press and hold "∨ TUNE" or "TUNE ∧" to move to a lower or higher frequency rapidly.

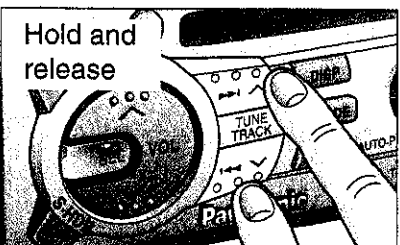

## Seek Tuning

Press and hold "∨ TUNE" or "TUNE ∧" for more than a half second, then release. The radio automatically stops on the next station.



# Preset Station Setting

Up to 24 stations can be preset in the station memory as follows;

FM1	FM2	FM3	AM(LW/MW)
6 stations	6 stations	6 stations	6 stations

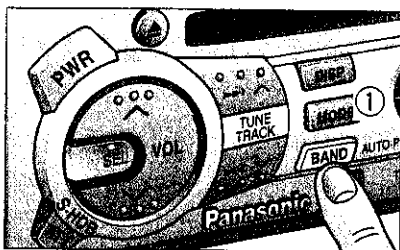

## Manual Station Preset

- ① Press BAND to select a desired band.
- ② Use manual or seek tuning to find a station that you want to program into memory.
- ③ Press and hold one of the station selector buttons 1 through 6 for more than 2 seconds until the display blinks. Repeat the process to set other stations for the FM1 to AM bands.

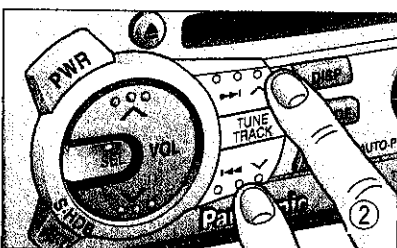

**Note:** You can change the memory setting by repeating the above procedure.

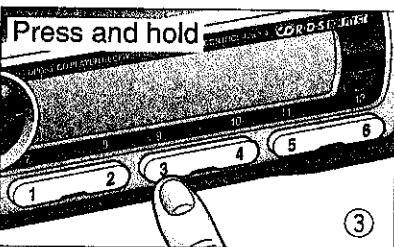

## Tuning in a Preset Station

Press any of the buttons 1 through 6 to tune in the station preset by the above steps ① to ③.

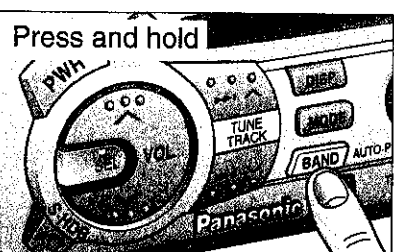

## Auto Station Preset

Select a band and press and hold BAND (AUTO·P) for more than 2 seconds.

- The six strongest available stations will be automatically set in memory on preset buttons 1 through 6.
- Once set, the preset stations are sequentially scanned for 5 seconds each.
- Press the appropriate preset button for the station you want to hear.

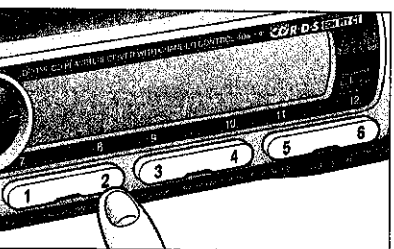

**CAUTION:** For safety reasons, do not attempt to program while driving.

# RDS (Radio Data System) Reception

Many FM stations are broadcasting added data compatible with RDS. This radio set offers convenient functions using such data.

## **AF (Alternative Frequency)**

When receiving condition becomes poor, an RDS station with the same program will be automatically selected.

## **EON (Enhanced Other Networks)**

When EON data is received, the EON indicator lights and the TA and AF functions are expanded.

**TA:** Traffic information from not only the station now tuned in to but also other stations of the same network can be received.

**AF:** The frequency list of the RDS stations preset by received EON data is updated.

## **PS (Program Service Name)**

When an RDS station is received, the RDS indicator lights and automatically displays the name of that station instead of the frequency. When DISP is pressed during PS display, the frequency is displayed for 3 seconds, then PS display returns.

## **PI (Program Identification)**

If a preset RDS station is poor in receiving condition when it is selected, the automatic seek (PI Seek) starts to seek the same program and tune in to it.

## **PTY (Program TYPe)**

Program type identification signal

## **TA (Traffic Announcement)**

When an FM station that periodically provides the latest traffic information is received, the TP indicator lights. If TA ON is set, FM traffic information automatically interrupts your listening to a CD, CD changer source until it ends, then you will listen again to whatever you have been listening to.

## **REG(Region)**

The AF, Best Station Research, PI Seek functions will be as follows:

**REG ON :** The frequency changes only with the same regional program. This function is mainly used while driving in the same area, for example, in a city.

**REG OFF:** The frequency changes even with a different regional program if the station is in the same network. The broadcast may be different depending on the case. This function is mainly used when driving far from one region to another.

## **WHAT PROVIDES EON CAPABILITIES**

EON lets the radio set take advantage of RDS information much more than before. It constantly updates the AF list of all presets, including the station currently tuned in to. So, even if you change preset far from home, you will be able to receive the same station at an alternative frequency, or another station serving the same program if any. EON also keeps track of locally available TP stations for quick reception.

**Note:** When you're in "AF ON" mode, auto preset memory only works for RDS station. When in "TA on" mode, it only works for TP stations. To make auto preset for ordinary stations, cancel AF mode and switch to TA off in advance.

# A. Basic Operation in RDS Reception (PS, AF, CT, PI)

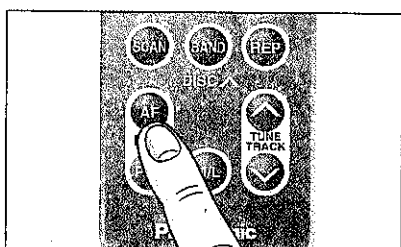
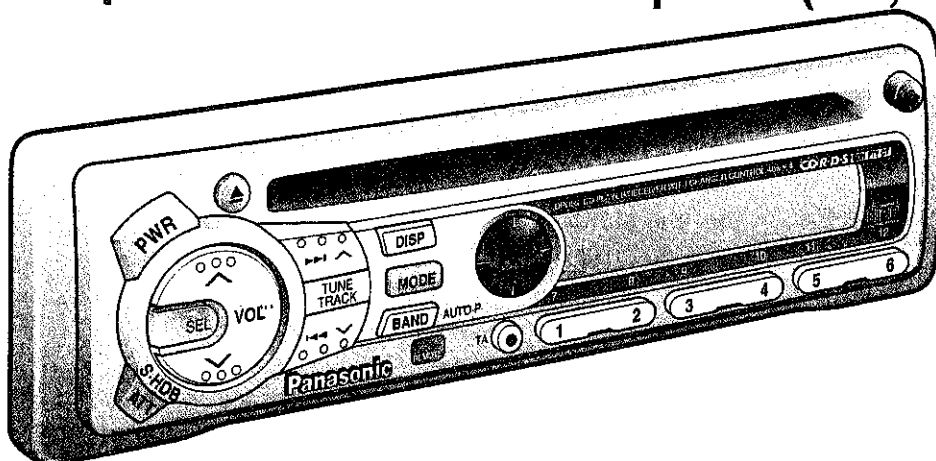

<Remote control operation>

## RDS Reception

(Use the remote controller for the following operation.)

Press AF when receiving a station in the FM1, FM2 or FM3 band.

- The operating mode changes to AF ON or AF OFF, respectively.

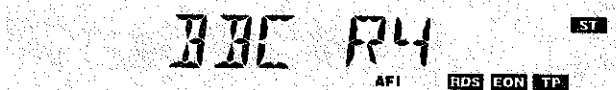

- Select AF ON if you wish to use the AF network of an RDS station. Best station research is activated at the same time.
- Select AF OFF if the AF network of an RDS station is not necessary.

## Best Station Research

If a preset RDS station is in poor condition of reception when you try to tune in to it, the best frequency is selected from the AF list of that station.

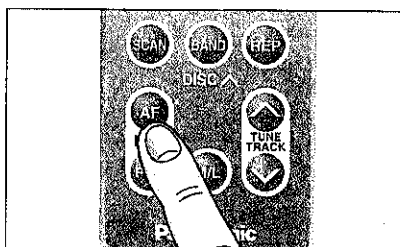

<Remote control operation>

## To Change AF Mode

(Use the remote controller for the following operation.)

Press AF to change AF ON and activate Best Station Research at the same time. (3 seconds maximum)

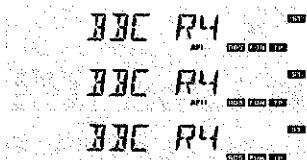

### Notes:

1. Default mode is AF1.
2. AF1 has a low level of AF operating sensitivity in urban areas. Therefore, AF does not frequently operate even if sensitivity is temporarily lowered between skyscrapers, for examples.
3. AF2 is for suburban areas with a higher level of sensitivity than AF1.

# RDS (Radio Data System) Reception continued

For Seek Tuning, RDS Station Preset, Tuning in a RDS preset station, and Auto RDS Station Preset, please refer to Radio Basics (Page 16 to page 17).

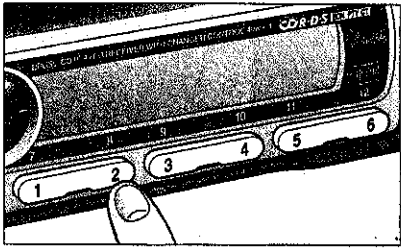

## RDS seek tuning (PI seek)

The PI seek function may be used if an RDS station selected from the memory is poor in receiving condition. Press the preset button again for the station now tuned in to.



**PI Seek:** If Best Station Research fails in selecting the best station, the PI seek function operates to automatically tune in to the same program.

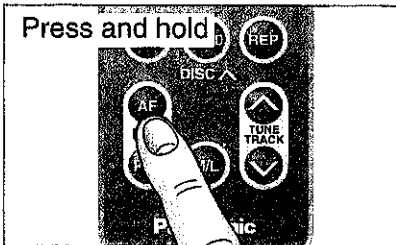

<Remote control operation>

## Region (REG) Switching

(Use the remote controller for the following operation.)

Press and hold AF for more than 1 second in AF mode to alternately select REG ON and REG OFF.

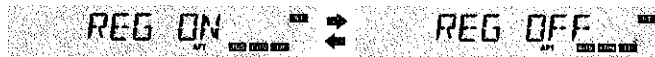

**Note:**

If you wish to stay with the same program, keep REG ON. If you keep REG OFF, there is a higher possibility of returning in to an AF station in better receiving condition.

The relationship of the PI seek function with REG ON and REG OFF is as described above.

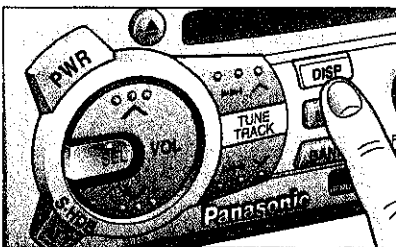

## Changing Display

- Press DISP to change the display as follows.

(Frequency display continues for only 3 seconds, returning to PS display after that.)

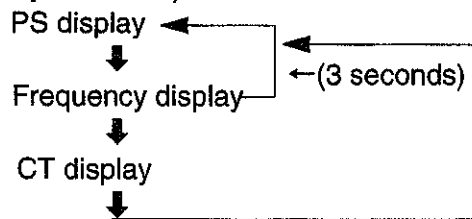

## Clock Time (CT) System

The CT (24-hour) system may not properly operate in areas where RDS CT service is not available. Once CT service is received, the CT system keeps operating. "NO CT" is displayed in areas where no CT service is available.



## Clock Display

Press DISP to indicate the clock display.



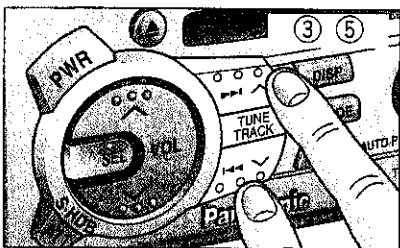
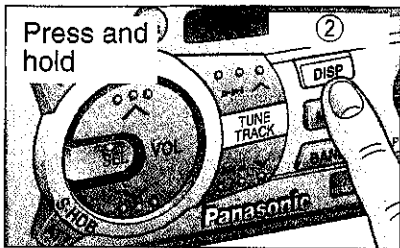
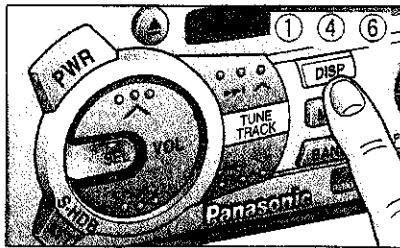

# Initial Time Setting

Press BAND to change to AM mode.

- ① Press DISP. "NO CT" is displayed.
- ② Press and hold DISP again for more than 2 seconds. "hours" blinks indicating the time setting mode is activated.
- ③ To set hours, press "TUNE ^ or VTUNE".
- ④ Press DISP again for minutes setting.
- ⑤ To set minutes, press TUNE ^ or VTUNE. Hold " ^ " or " V " change numbers rapidly.
- ⑥ When set the time, press DISP.

**Notes:**

- If CT display is kept on, it remains on even if PWR and ACC are tuned off and back on again.
- In CD Changer mode, press and hold DISP for more than 2 seconds (In FM, CD mode, press DISP) to get RDS CT-service.

## B. TP Reception

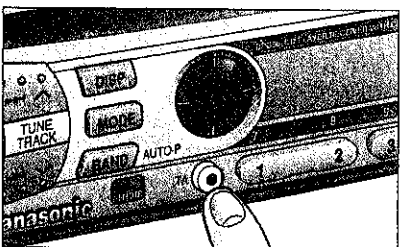

### Select traffic information (TA on) mode

Press TA to switch ON and keep it there when you wish to listen to traffic information. Press TA to switch OFF when no traffic information is needed.

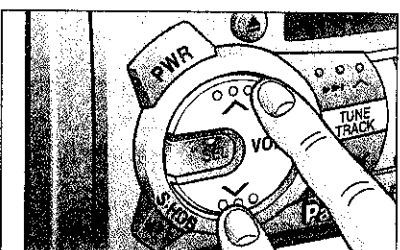
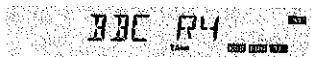

### Volume Setting (Only for CD/CD-C TA on mode)

Adjust the volume as desired using "VOL ^" or "V VOL" while receiving traffic announcement. (TA)

After volume for traffic announcement (TA) is set, the difference between normal volume and TA volume is automatically stored in the memory (up to 5 levels) so that next traffic information will be received at the preceding TA volume which may be higher or lower than normal volume.

Normal volume can be changed up to 5 levels upward or downward. If an adjusted level of volume is over 40 or less than 0, any further change will not be made.

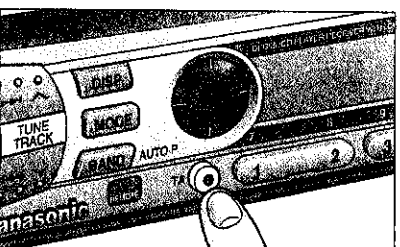

### When receiving a station other than TP station (including EON stations)

A traffic information station is automatically searched for and the radio automatically stops the next available TP station. EON Capabilities:

EON lets the radio take advantage of much more RDS information than before. It constantly updates the AF lists for all switch presets far from home, you will receive an alternative frequency for the same station, or another station carrying the same program, when such exists. EON also keeps track of locally available TP station.

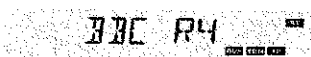

→  
Press TA.



# RDS (Radio Data System) Reception continued

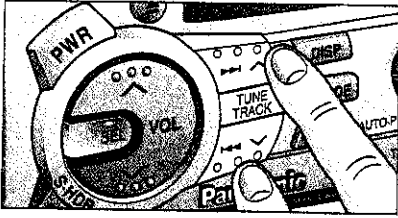

## TP Seek Tuning

Press "∨TUNE" or "TUNE∧" for more than a half second, then release. The radio automatically stops on the next available TP station.

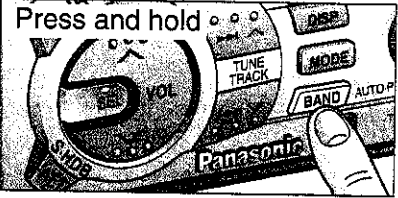

## Auto TP Station Preset

Press and hold BAND (AUTO · P) for more than 2 seconds until the display blinks in TA on. The six strongest available TP stations are automatically set in memory on the preset button 1 through 6.

Once set, the preset stations are sequentially scanned for 5 seconds each.

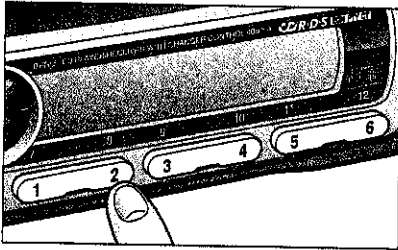

## Tuning in a TP station preset

Press any of the preset buttons 1 through 6 that you want to hear. And then Best Station Research function is activated to automatically select the strongest available frequency for the TP station (through the built-in frequency lists, if reception is weak.

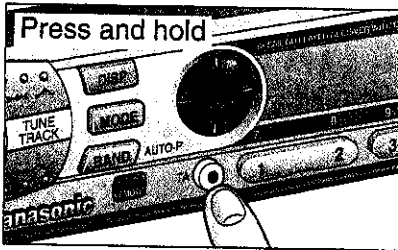

## Muting TA on

Press and hold TA for more than 2 seconds to light "TA on". Then Traffic Announcement (TA) function is activated to operate, allowing you to listen to only Traffic Program whenever it is available.

## Muting TA on canceling (Muting TA on → TA on)

Press TA again.

Press "VOL∧" to increase the volume level.

## TP Auto Search

If receiving conditions are poor when TA is on during muting and if there is no other alternative frequency in the same network, a traffic announcement station in good receiving condition is automatically searched for.

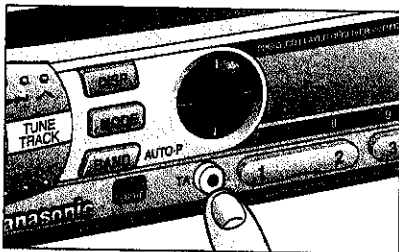

## CD/CD-C TA on

Press TA during CD, CD changer mode.

TA on mode is selected, while listening to the source in that mode, wait for Traffic Announcement to being.

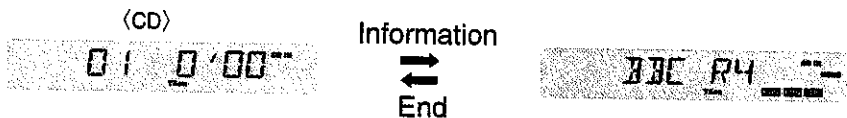

## Switching to TA off Mode

Select either one of the following steps.

- Press TA when TA is ON.
- Press and hold TA for more than 2 seconds when Muting TA is ON.
- Press TA when CD/CD-C TA is ON.

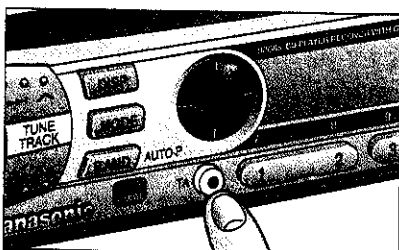

# C. PTY Reception

(There are some areas where PTY service may not be available.)

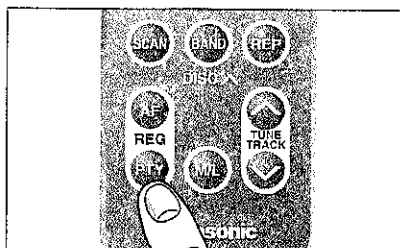

<Remote control operation>

## Switching to PTY mode

(Use the remote controller for the following operation.)  
Press PTY to select PTY display mode, and the PTY of the broadcast now received is displayed.

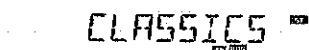

"NO PTY" is show if there is no corresponding program type.

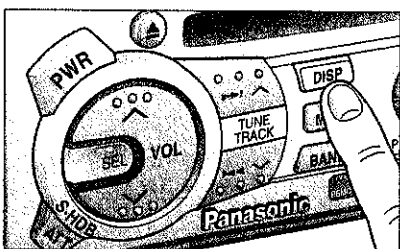

## Changing PTY Display Language

Pressing DISP each time in PTY mode to alternate the language between English and Swedish.

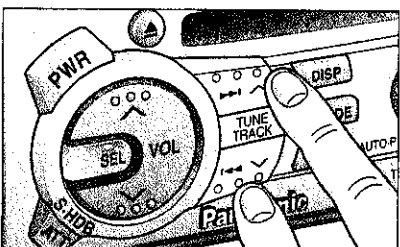

## Program Type Selection

Press "∨ TUNE" or "TUNE ∧" to select the program type in sequence as follows.

- SPEECH - MUSIC - NEWS - AFFAIRS - INFO - SPORT - EDUCATE - DRAMA
- ROCK M - POP M - VARIED - SCIENCE - CULTURES
- M.O.R.M - LIGHT M - CLASSICS - OTHER M - WEATHER - FINANCE
- LEISURE - TRAVEL - PHONE IN - RELIGION - SOCIAL A - CHILDREN
- JAZZ - COUNTRY - NATIONAL - OLDIES - FOLK M - DOCUMENT

When the desired selection has been made, press BAND. Then automatic seek will start to tune into the station broadcasting the selected program type.

**Note :**

Seek tuning does not operate as long as "NO PTY" is displayed.

# RDS (Radio Data System) Reception continued

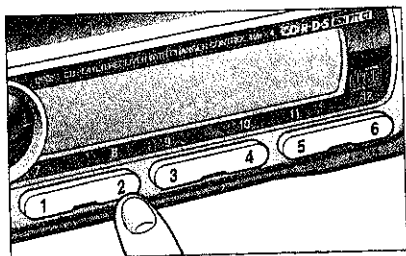

## TABLE of PTY CODE and program Type

Press any of the preset button 1 through 6 that you want to desire the program type. Those buttons are already stored program types as below. (Initial setting)

### <PRESET PTY>

Preset NO.	1	2	3	4	5	6
Program Type	NEWS	SPEECH	SPORTS	POP. MUSIC	CLASSICS	MUSIC
Display	NEWS 1	SPEECH 2	SPORT 3	POP M 4	CLASSICS 5	MUSIC 6
	NEWS	AFFAIRS INFO EDUCATE DRAMA CULTURES SCIENCE VARIED WEATHER FINANCE CHILDREN SOCIAL A RELIGION PHONE IN TRAVEL LEISURE DOCUMENT	SPORT	POP M	CLASSICS	ROCK M M.O.R.M LIGHT M OTHER M JAZZ COUNTRY NATIONAL OLDIES FOLK M

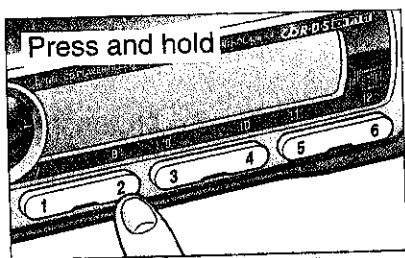

## Program Type Preset

Press and hold one of the buttons 1 through 6 for more than 2 seconds to preset the desired program type selection in that button.

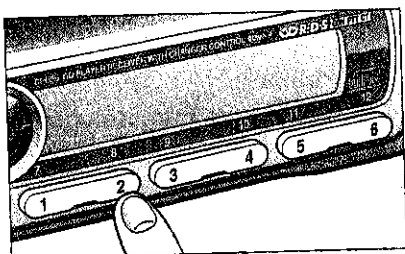

## Tuning in a PTY Preset Station

Press any of the preset buttons 1 through 6 that you want to hear.





<Remote control operation>

## Searching for PTY

(Use the remote controller for the following operation.)

- ① Select the desired station from among those preset in the preset number buttons 1 through 6. (The buttons of Main unit.) Then, the preset PTY and that preset number are displayed for 5 seconds. (When PTY is displayed, PTY may be searched for with the BAND button after selecting PTY with “∨ TUNE” or “TUNE ∧”.)



- ② While the desired type from 6 presets is displayed, take either of the following two steps.

- A) Press the same preset button again. (The buttons of Main unit.)
- B) Press BAND.

If the desired PTY station is available, it is directly received. If it is not, “NO PTY” blinks and the radio returns to the station that was received before the search.

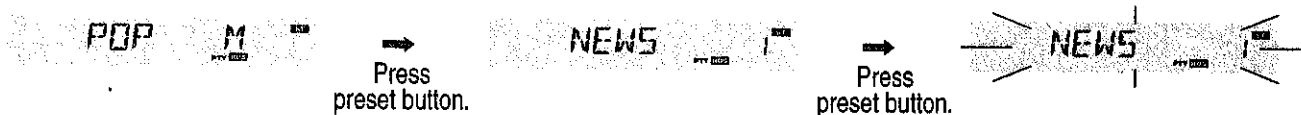

Press the same button again to cancel.



<Remote control operation>

## Canceling of PTY Mode

(Use the remote controller for the following operation.)

Press PTY to cancel.

The set returns to the state existing before PTY mode while the receiving frequency remains unchanged.

## Emergency Announcement Reception

(Some areas are not covered by emergency announcement service.)

If an emergency announcement is broadcast during CD/CD changer mode, the radio is automatically selected to receive the emergency announcement. “ALARM” blinks.

# Compact Disc Player Basics

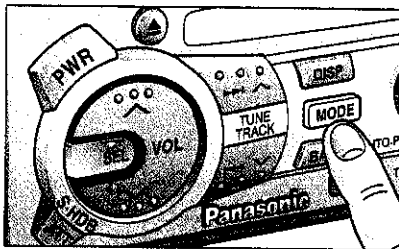
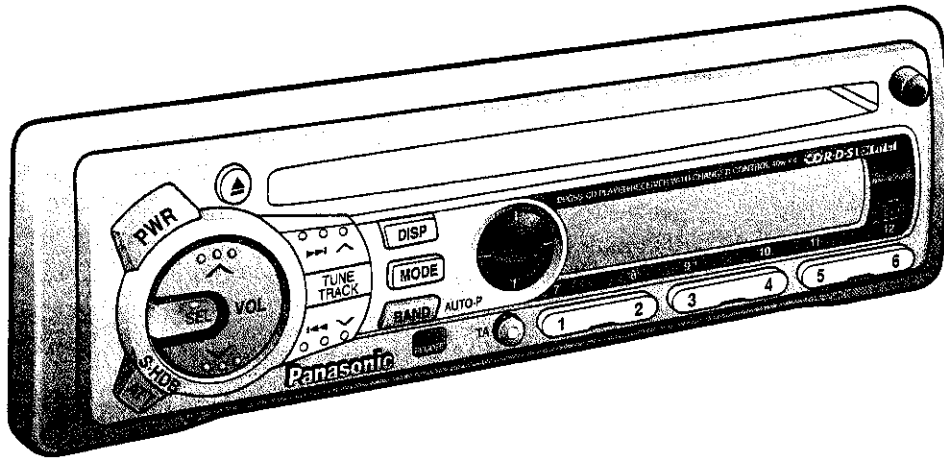

## Mode Selection

Press MODE to change into the CD player mode.

## To start the CD Player

Insert the disc and playback starts automatically.

"CD LOAD" will be displayed until the disc is loaded. Play starts from first track.



**Note:** While the disc is inserted, "CD IN" indicator will light.

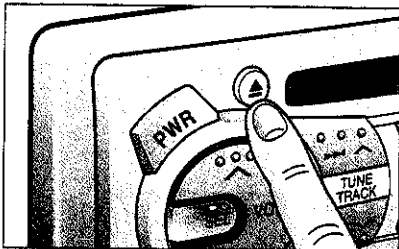

## Stopping and Ejecting a Disc

Press "▲" to stop CD play, and the disc will quietly eject from the CD slot. (During disc ejection, "CD EJECT" will be displayed.)

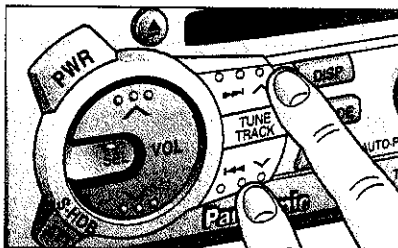

## Selecting a Track

- Press "TRACK▶▶▶" once to go to the next track.
- Press "◀◀◀TRACK" once to play from the beginning of the track you are listening to. Press twice to play the previous track.
- Press repeatedly to skip the desired number of tracks.

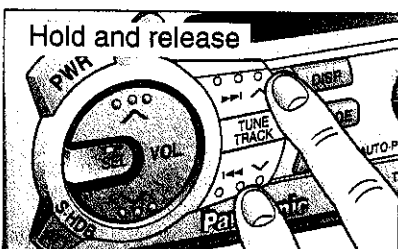

## Searching a Track

- Press and hold "TRACK▶▶▶" or "◀◀◀TRACK" for more than a half second to activate fast forward or reverse through a track.
- Release "TRACK▶▶▶" or "◀◀◀TRACK" to resume the normal CD play.

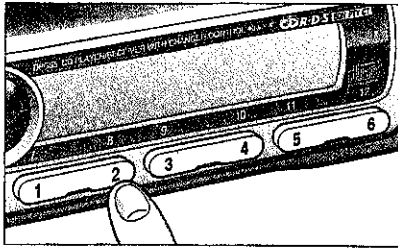

## Selecting by Track Number (Direct Track access)

- Press a number from "1" to "6" than the corresponding track will start.
- Press and hold a number from "7" to "12" ("1" to "6") for more than one second and the corresponding track will start.

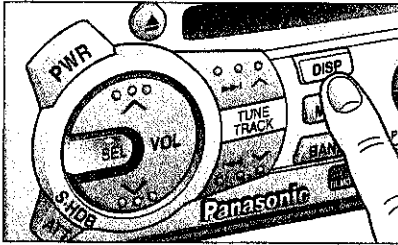

## Changing the Display

Press DISP to switch the display in sequence as follows.

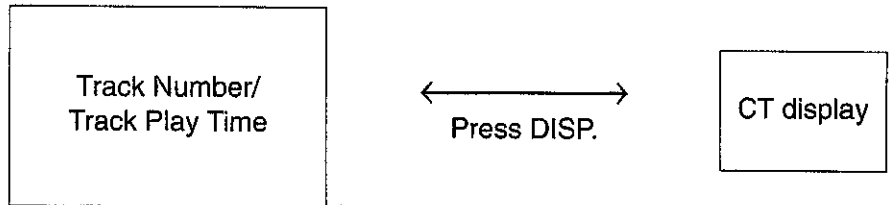

## Error Display Messages

E1	Displays when the compact disc is dirty or upside down. The disc eject automatically. But, the disc may eject automatically, even if this error message is not displayed.
E2	Displays when compact disc is scratched. The disc eject automatically. But, the disc may eject automatically, even if this error message is not displayed.
E3	Displays when the compact disc stops operating for some reason. Please turn off the car engine (ACC off) and remove the fuse from yellow lead for 1 minute. Then reinstall the fuse.

# CD Changer Basics

## Note:

CD changer control functions are applicable to units with optional CD changer unit. (sold separately)

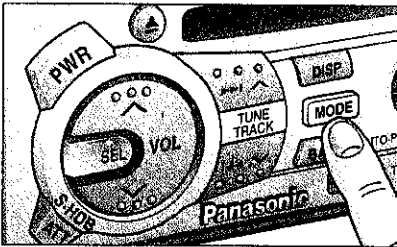
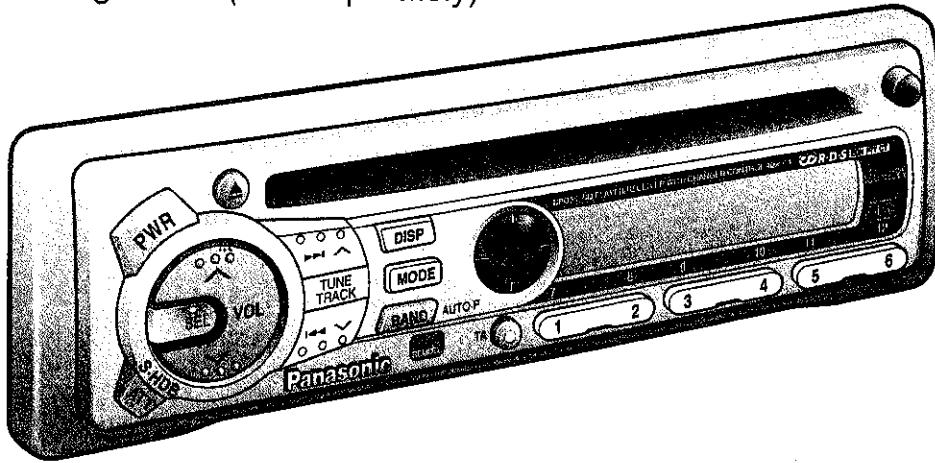

## To start the CD Changer

While CD changer is connected, press MODE to change into the CD changer mode and playback starts automatically.

CHE 1-01

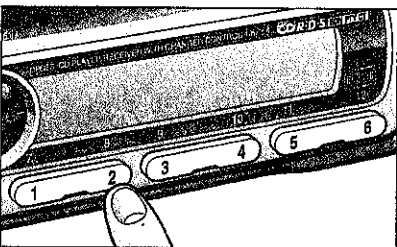

## Selecting a Disc (Direct Disc access)

- Press a number from "1" to "6" than the corresponding Disc will start.
- Only for CX-DP1200EN
- Press and hold a number from "7" to "12" ("1" to "6") for more than one second and the corresponding Disc will start.

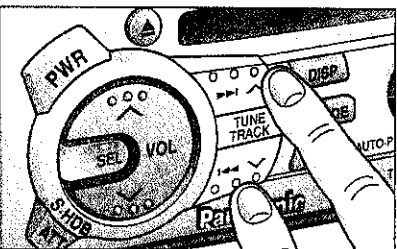

## Selecting a Track

- Press "TRACK ►►" once to go to the next track.
- Press "◄◄ TRACK" once to play from the beginning of the current track. Press twice to play the previous track.
- Press repeatedly to skip the desired number of tracks.



## Searching a Track

- Press and hold "TRACK ►►" or "◄◄ TRACK" for more than a half second to activate fast forward or reverse through a track.
- Release "TRACK ►►" or "◄◄ TRACK" to resume the normal CD play.

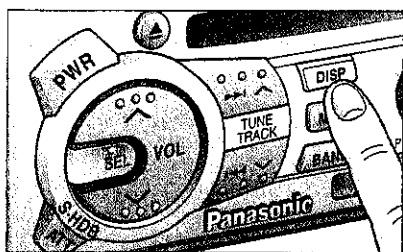

## Changing the Display

Press DISP to switch the display in sequence as follows.

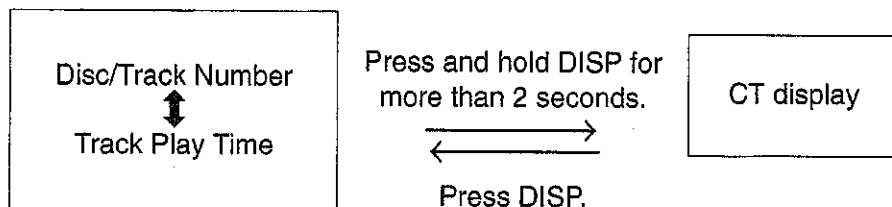

## Error Display Messages

	<p>Displays when the compact disc is dirty or upside down. Selects the next available compact disc.</p>
	<p>Displays when compact disc is scratched. Selects next available compact disc.</p>
	<p>Displays when the unit stops operating for some reason. Press RESET on the CD Changer (optional).</p>
	<p>Displays when there is no disc in the magazine.</p>

# Remote Control Basics

## Battery Replacement:

**1. Remove the battery holder.**  
Pull the holder by the Position B while pushing Position A in the direction indicated by the arrow.

**2. Replace the battery.**  
Set a new battery properly with (+) side up as illustrated.

**3. Insert the battery holder.**  
Push in the holder to the original position.

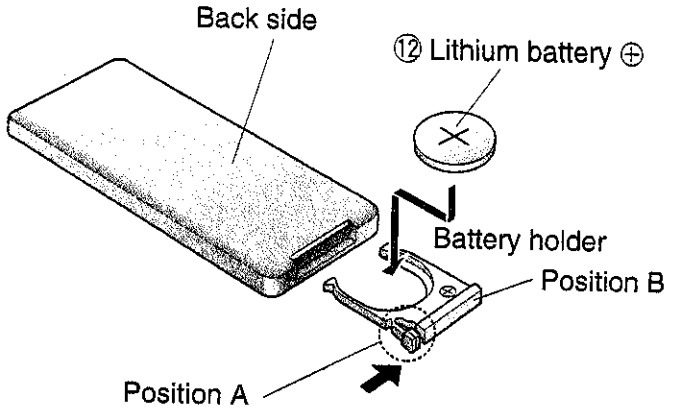

## Note on Batteries:

Old batteries must immediately be removed and disposed.

Battery Information:

- Designated Battery: Panasonic Lithium Battery (CR2025)
- Battery Life: 6 months with normal use (in normal room temperature)

**Caution:**

Improper use of batteries may cause overheating, explosion or ignition, resulting in injury or fire. Battery leakage may cause damage to the unit.

- Do not disassemble or short the batteries. Do not throw the batteries into the fire.
- To avoid the risk of accident, keep the batteries out of reach of children.

## Names of Main Controls:

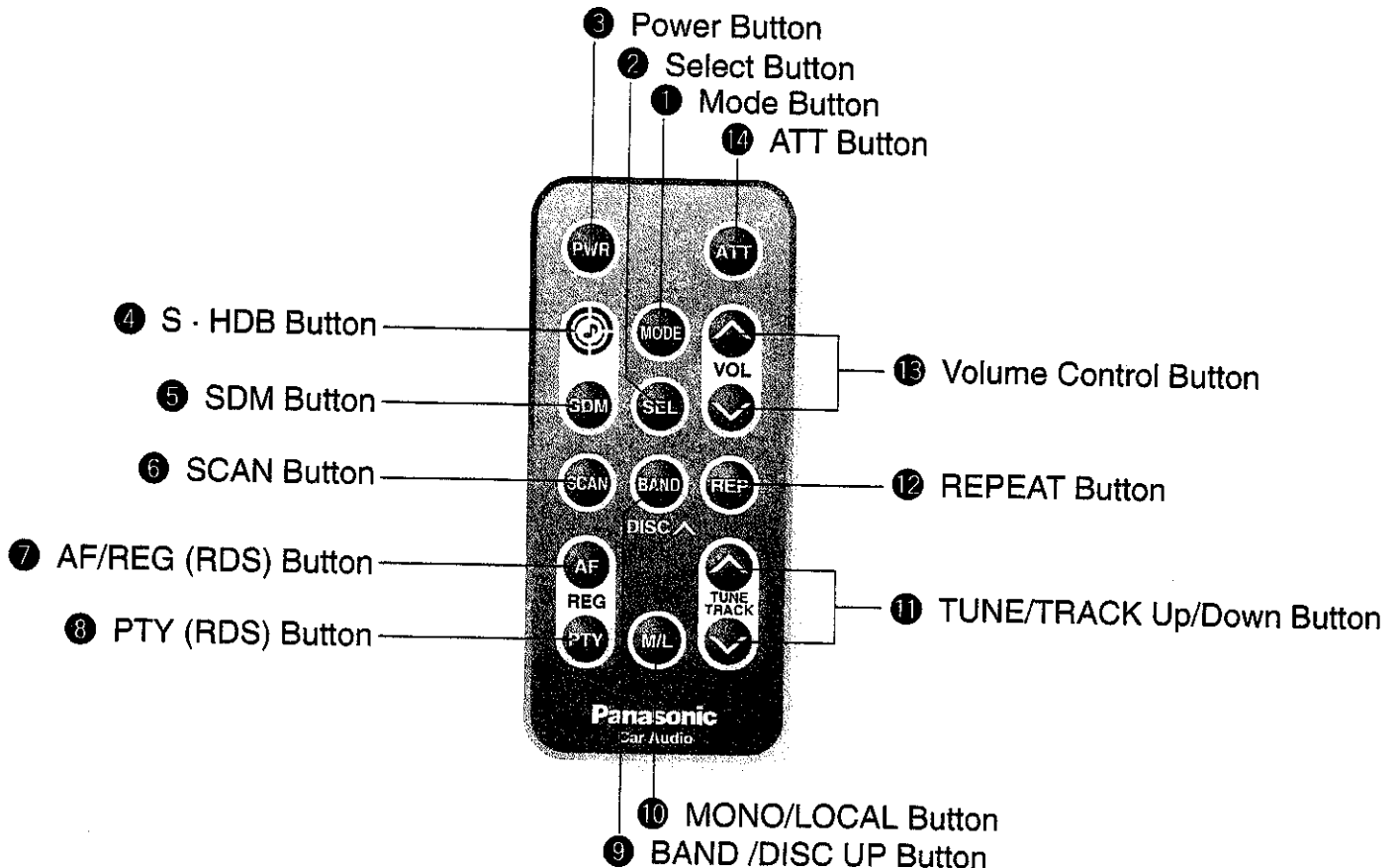

# Operating Procedures

Aim the remote controller toward the sensor of the main unit.

## General

### Power

#### ③ PWR (Power Button)

Press PWR to switch on the power.  
Press PWR again to switch off the power.

### Mode Selection

#### ① MODE (Mode Button)

Press MODE to switch the operation mode in the following order.

Tuner → CD Player → (CD Changer Control)  
↑ ↓

### Volume

#### ⑬ ∇VOL∧ (Volume Control Button)

Press "∧" or "∇" to increase or decrease volume level.

### Super High Definition Bass

#### ④ S · HDB Button

- Press  (S · HDB) to be able to listen to high-definition bass.
- Press the same button again to cancel.

### Attenuator

#### ⑭ ATT Button

- Press ATT to decrease volume to about 1/10 of the previous level.
- Press ATT again to cancel.

### Changing Audio Modes

#### ② SEL (Select Button)

Press SEL to switch the audio control mode in the following order.

Normal Mode → VOL → BAS → TRE → BAL → FAD  
↑ ↓

### Bass and Treble

#### ⑬ ∇VOL∧ (Volume Control Button)

Press SEL to select the BASS (TREBLE) mode. Press "VOL∧" or "∇VOL" to increase or decrease the bass (treble) response.

### Balance

#### ⑬ ∇VOL∧ (Volume Control Button)

Press SEL to select the BALANCE mode. Press "VOL∧" or "∇VOL" to shift the sound volume to the right or left speakers.

### Fader

#### ⑬ ∇VOL∧ (Volume Control Button)

Press SEL to select the FADER mode. Press "VOL∧" or "∇VOL" to shift the sound volume to the front or rear speakers.

## Sound Memory (Only for Remote Control)

### Changing Sound Memory

#### ⑤ SDM (SDM Button)

Press SDM to switch the sound memory in the following order.

Initial → SOUND 0 → SOUND 1 → SOUND 2 → SOUND 3  
↑ ↓

Sound memory settings are as follows.

	BAS	TRE	BAL	FAD	S·HDB
SOUND 0 (at Initial)	0	0	Center	Center	OFF
SOUND 1 (On expressways: recommended)	+6	+3	Center	Center	OFF
SOUND 2 (Vocal emphasized)	-6	-6	Center	Center	OFF
SOUND 3 (Bass emphasized)	0	+3	Center	Center	ON

#### Notes : Desired sound memory input:

- If SDM is pressed at SOUND 0, 1, 2, or 3 after changing BAS, TRE, BAL, FAD, or S·HDB settings, the selected condition is stored in the memory of "SOUND 0".
- When "SOUND" is not displayed, press SDM to show current SOUND mode. Mode change is valid only when "SOUND" is displayed.

# Remote Control Basics continued

## Radio

### To change Tuner Mode

#### ① MODE (Mode Button)

Press MODE to switch the operation mode in the following order.

Tuner → CD Player → (CD Changer Control)

### Manual Tuning

#### ① ∇TUNE∧ (Tuning Button)

Press "∇TUNE" or "TUNE∧" to turn the frequency downward or upward.

### Selecting a Band

#### ⑨ BAND (BAND select Button)

Press BAND to select the band in sequence.

FM1 → FM2 → FM3 → AM

↑ ↓

### Seek Tuning

#### ① ∇TUNE∧ (Tuning Button)

Press and hold "∇TUNE" or "TUNE∧" for more than a half second, then release. The radio will automatically stop on the next station.

### MONO/LOCAL Selection

#### ⑩ MONO/LOCAL Button

- Much interference is reduced during a weak FM stereo broadcasts. when MONO is ON. (Only for FM mode)
- Searching stops automatically at a strong wave station only when LOCAL is ON.

#### ① During FM broadcasts.

Press M/L to switch the mode in the following order.

MONO OFF LOCAL OFF → MONO ON LOCAL OFF → MONO ON LOCAL ON → MONO OFF LOCAL ON

#### ② During AM broadcasts.

Press M/L to switch on or off the LOCAL mode as follows.

LOCAL OFF ↔ LOCAL ON

## RDS (Radio Data System) Reception

### RDS Reception

#### ⑦ AF (AF Button)

Press AF when receiving a station in the FM1, FM2 or FM3 band.

- The operating mode changes to AF ON or AF OFF, respectively.
- Select AF ON if you wish to use the AF network of an RDS station. Best station research is activated at the same time.
- Select AF OFF if the AF network of an RDS station is not necessary.

### To Change AF Mode

#### ⑦ AF (AF Button)

Press AF to change AF ON and activate Best Station Research at the same time. (3 seconds maximum)

### Region (REG) Switching

#### ⑦ AF (AF Button)

Press and hold AF(REG) for more than 1 second in AF mode to alternately select REG ON and REG OFF.

### Switching to PTY mode

#### ⑧ PTY (PTY Button)

Press PTY to select PTY display mode, and the PTY of the broadcast now received is displayed. "NO PTY" is show if there is no corresponding program type.

### Canceling of PTY Mode

#### ⑧ PTY (PTY Button)

Press PTY to cancel. The set returns to the state existing before PTY mode while the receiving frequency remains unchanged.

### Searching for PTY

#### ⑧ PTY (PTY Button)

- ① Select the desired station from among those preset in the preset number buttons 1 through 6. (The buttons of Main unit) Then, the preset PTY and that preset number are displayed for 5 seconds.
- ② While the desired type from 6 presets is displayed, take either of the following two steps.
  - A) Press the same preset button again. (The buttons of Main unit)
  - B) Press BAND.

If the desired PTY station is available, it is directly received. If it is not, "NO PTY" blinks and the radio returns to the station that was received before the search. Press the same button again to cancel.



# Compact Disc Player

(When a disc is inserted, playback starts.)

**To Start CD Play**  
**① MODE (Mode Button)**  
 Only when a disc is inserted, press to select CD play mode, and playback starts automatically.  
 Tuner → CD Player → (CD Changer Control)  
 ↑ ↓

When a disc is inserted, CD play starts automatically regardless what mode you are being listened.

**Selecting a Track**  
**① √ TRACK ^ (Track Select Button)**

- Press “^” once to go to the next track.
- Press “√” once to play from the beginning of the currently played track.
- Press repeatedly to skip forward or backward through all the tracks.

**Searching a Track**  
**① √ TRACK ^ (Track Select Button)**

- Press and hold “√” or “^” for more than a half second to activate fast forward or reverse through the track.
- Release to stop reverse or fast forward.

**Repeating a Track (Only for Remote Control)**  
**⑫ REP (Repeat Button)**  
 Press REP to repeat the current selection. “REP” indicator will light.  
 Press REP again to cancel.

**Scanning a Disc (Only for Remote Control)**  
**⑥ SCAN (SCAN Button)**  
 Press SCAN. The display will blink and the first 10 seconds of each track on the discs play in order.  
 Press SCAN again to cancel.

# CD Changer Control

(In connection with the CD Changer)

**To Start CD Play**  
**① MODE (Mode Button)**  
 When connecting with the CD changer, press repeatedly to select the mode as follows.  
 Tuner → CD Player → (CD Changer Control)  
 ↑ ↓

**Selecting a DISC**  
**⑨ DISC UP (BAND Button)**  
 Press DISC UP to sequentially advance to the next DISC.

**Selecting a Track**  
**① √ TRACK ^ (Track Select Button)**

- Press “^” once to go to the next track.
- Press “√” once to play from the beginning of the currently played track.
- Press repeatedly to skip forward or backward through all the tracks.

**Searching a Track**  
**① √ TRACK ^ (Track Select Button)**

- Press and hold “√” or “^” for more than a half second to activate fast forward or reverse through the track.
- Release to stop reverse or fast forward.

**Repeating a Track (Only for Remote Control)**  
**⑫ REP (Repeat Button)**  
 Press REP to repeat the current selection. “REP” indicator will light.  
 Press REP again to cancel.

**Scanning Track (Only for Remote Control)**  
**⑥ SCAN (SCAN Button)**  
 Press SCAN. The display will blink and the first 10 seconds of each track on the discs play in sequence.  
 Press SCAN again to cancel.

# Anti-Theft System

This unit is equipped with a removable face plate. By removing this face plate, the radio becomes totally inoperable. The security indicator will blink.

## To Remove the Removable Face Plate

- ① Switch off the power.
- ② Press the release button (  ). The removable face plate will be released.

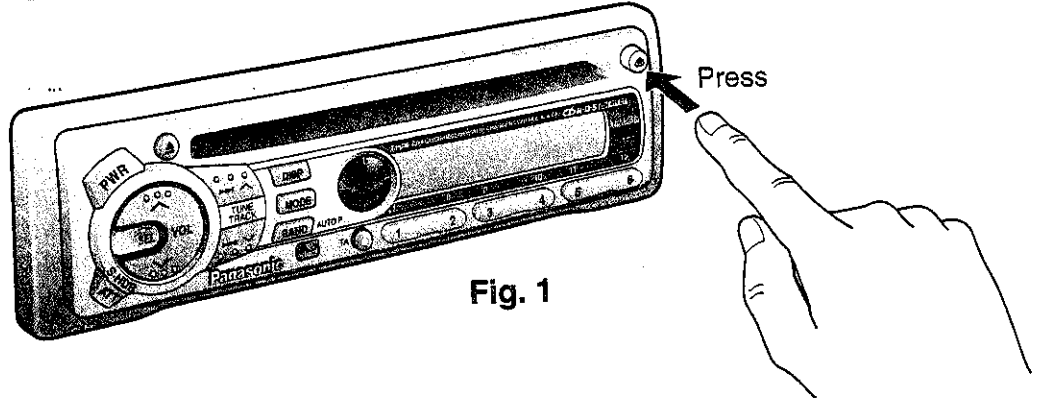

Fig. 1

- ③ Remove the removable face plate by pulling on the right side of the unit. Place the removable face plate in a supplied case.

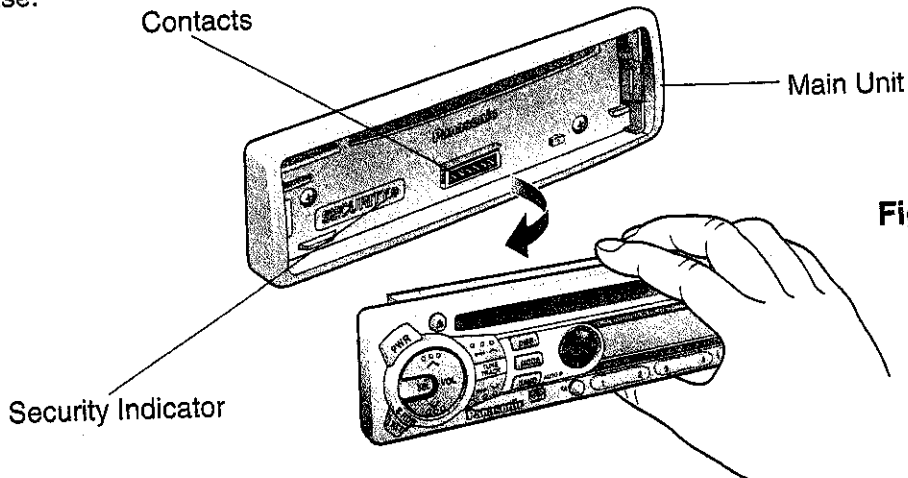

Fig. 2

- ④ As shown in Fig.3, insert the removable face plate with the arrow pointing toward the removable face plate case until you hear a "click". Keep the removable face plate in the case. Then, you can bring the plate safely.

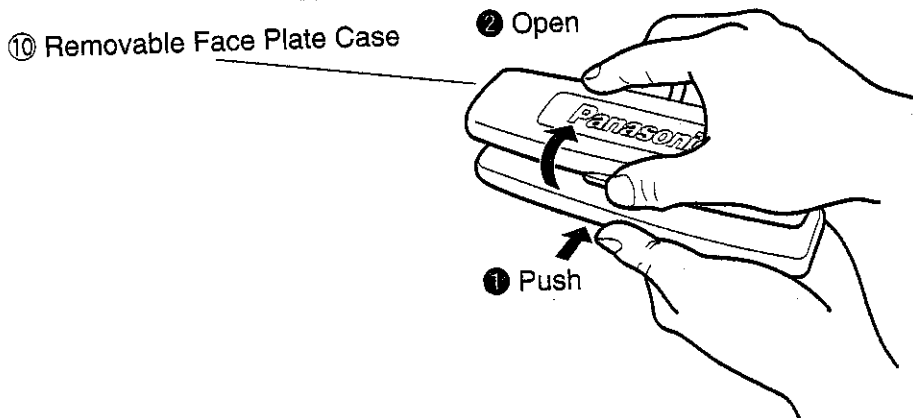

Fig.3

## To install the Removable Face Plate

① Slide the left side of the removable face plate in place.

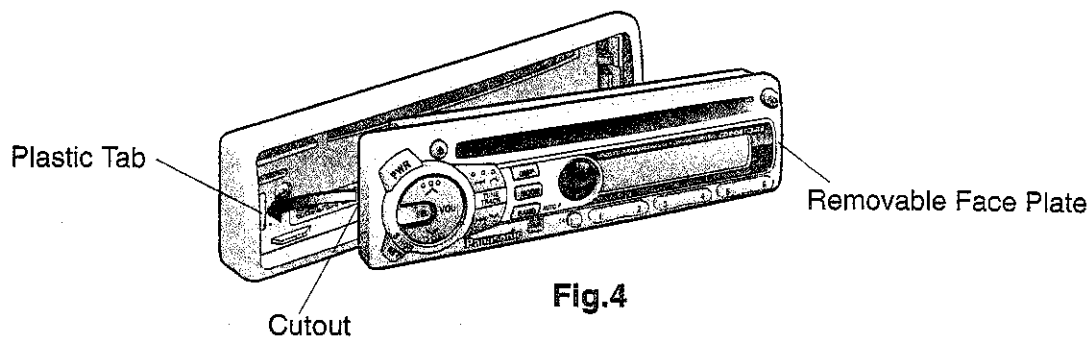

Fig.4

② Press the right end of removable face plate until "click" is heard.

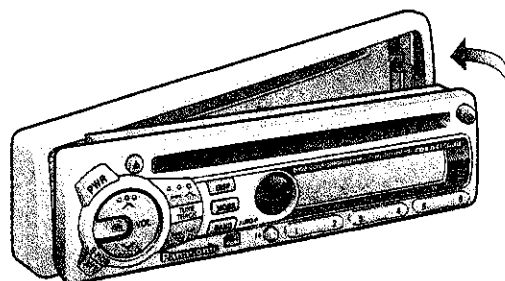

Fig.5

### Caution:

1. Before removing the removable face plate, make sure the power is off.
2. This removable face plate is not water-proof. Do not expose it to water or excessive moisture.
3. Do not remove the removable face plate, while driving your car.
4. Do not place the removable face plate on the dashboard or nearby areas where the temperature rises to high levels.
5. Do not touch the contacts on the removable face plate or on the main unit, since this may result in poor electrical contacts.
6. If dirt or other foreign substances get on the contacts, wipe them with a clean, dry cloth.

# Anti-Theft System continued

## Warning Alarm

### Caution

This car radio is equipped with an integrated Warning Alarm in order to make robbery more difficult. But it has to be secured that the installation will be properly done so that the Warning Alarm may work in a perfect way. Concerning the installation the following points have to be observed:

1. The supplied mounting collar has to be firmly fixed with the mounting tabs to the dashboard.
2. The radio has to be put into the mounting collar in that way that it exactly ends with the collar.
3. Please make sure that the technical features (impedance and power) of the speakers installed correspond to the specifications of this car radio (see technical specifications).

Only when these three points are observed during the installation, the correct function of the "Warning Alarm" will be secured.

If the main unit is not correctly wired and installed, the system may accidentally sound the alarm.

## Warning Alarm and Security Indicator

The security indicator blinks when the removable face plate is removed from the unit. Furthermore, the alarm will set off for 1 minute then reset when an attempt is made to remove the unit from the mounting collar.

### Activate Warning Alarm and Security Indicator

1. Press and hold SEL for more than 4 seconds when the power is ON. "ALRM ON" is displayed, and the security indicator and Warning Alarm turn ON.

**Note:** The ALARM mode is inactivated when it is shipped.

2. To check whether the unit is set in the ALARM ON mode, make sure that the security indicator blinks when the removable face plate is removed.

Display	Security Indicator	Warning Alarm	Panel Removal Alarm
ALRM ON	Blinks	ON	ON
(Press and hold SEL for more than 4 seconds.)			
ALRM OFF	OFF	OFF	OFF

### Caution:

1. Warning Alarm system may not operate if the exclusive supplied mounting collar is not used. This mounting collar will set off the alarm when the unit is being removed.  
If the main unit is not correctly wired and installed, the system may accidentally sound the alarm.
2. When removing or installing the unit, make sure that it is in the ALARM OFF mode.
3. When the Warning Alarm is activated by mistake, or when you want to remove the unit, the Warning Alarm and the security indicator functions can be canceled by the following steps of procedure.
  - Install the removable face plate.
  - Disconnect the power connector.

## Panel Removal Alarm

This alarm sounds to warn you not to forget to remove the panel before leaving your car. This function is activated when the security alarm is ON.

# Installation

## Preparation

- Before installation check the radio operation with antenna and speakers.
- Disconnect the cable from the negative (-) battery terminal (see caution below).

### Caution:

For installation to cars with trip or navigational computers, all electronic memory settings previously registered in the computer will be lost when the battery terminal is disconnected. For this type of car, battery could not be disconnected. Therefore, extra care should be taken to prevent short circuiting.

## In-dash Installation

### Installation Opening

In-dash installation can be done if the car's dashboard has an opening for this unit as shown in Fig.

1. The car's dashboard should have a thickness of 4.5mm - 6mm in order to make the installation of the unit.

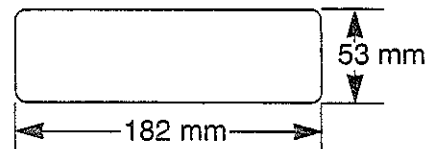

Fig. 1







## Installation Precautions



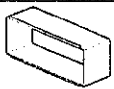

This equipment, if possible, should be installed by a professional installer.

In case of difficulty, please consult your nearest authorized Panasonic Service Center.

1. This system is to be used only in a 12-volt, DC battery system (car) with negative ground.
2. Follow the electrical connection on page 40 carefully. Failure to do so may result in damage to the unit.
3. Connect the power lead after other connections are made.
4. Be sure to connect the YELLOW lead to the positive terminal (+) of the battery or fuse block (BAT) terminal.
5. Insulate all exposed wires to prevent short circuiting.
6. Secure all loose wires after installing the unit.
7. Please carefully read the operating and installation instructions of the respective equipment before connecting it to this unit.

## Supplied Hardware

No.	Item	Diagram	Q'ty
①	Mounting Collar		1
②	Plain Washer (5 mmφ)		2
③	Spring Washer (5 mmφ)		2
④	Hex. Nut (5 mmφ)		2
⑤	Rear Support Strap		1
⑥	Hex. Bolt (5 mmφ x 25 mm)		1
⑦	Toothed Lock Washer (5 mmφ)		1

No.	Item	Diagram	Q'ty
⑧	Mounting Bolt (5 mmφ)		1
⑨	Power Connector		1
⑩	Removable Face Plate Case		1
⑪	Remote Control Unit		1
⑫	Lithium Battery		1

# Installation continued

## Installation Procedures

### 1. Secure the Mounting Collar ①.

Insert Mounting Collar ① into the car's dashboard, and bend mounting tabs out with a screwdriver.

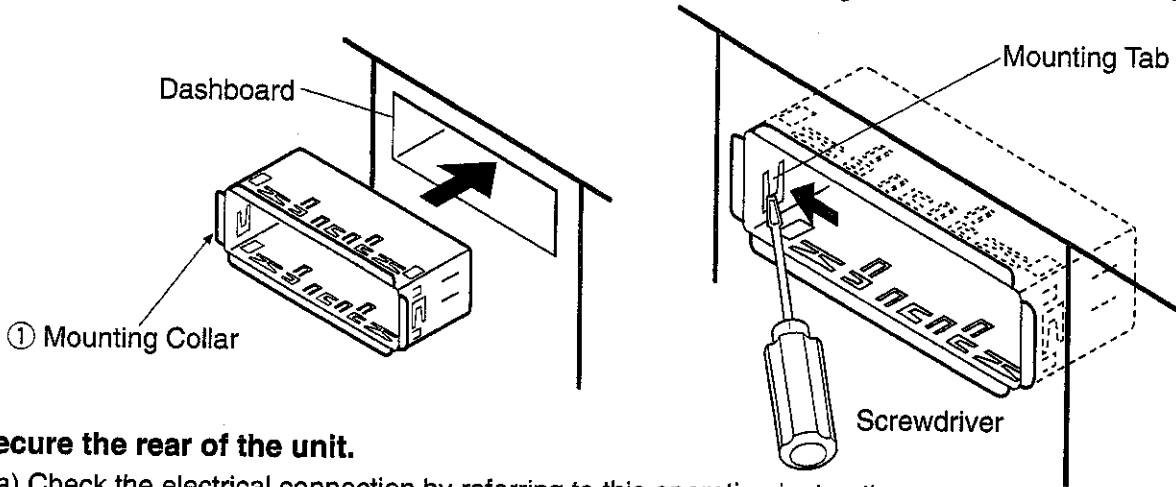

### 2. Secure the rear of the unit.

- a) Check the electrical connection by referring to this operating instructions.
- b) Connect the Mounting Bolt ⑧, using a suitable wrench.
- c) Insert the unit into Mounting Collar ① and push it in until "click" is heard.

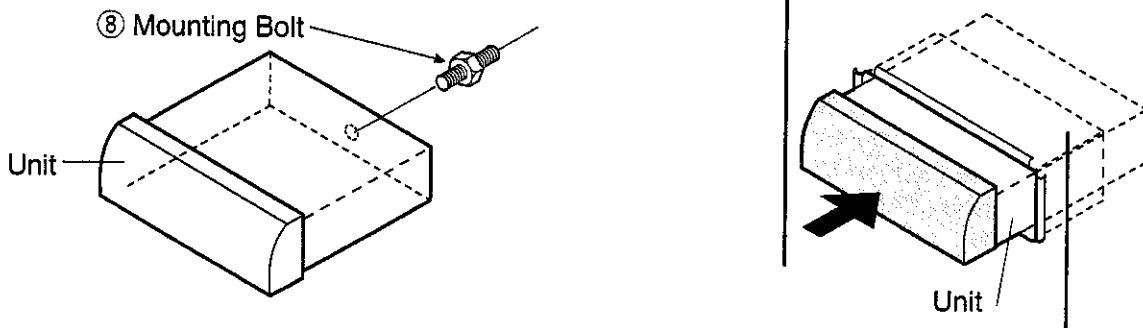

d) Secure the rear of the unit to the car by either of the two recommended methods.

#### ■ Using the Rear Support Strap ⑤

Affix one end of the Rear Support Strap ⑤ to the rear of the unit, and the other end to the Fire Wall of Car, or some other metallic area.

#### ■ Using the Rubber Cushion (Optional)

(If there is an existing Rear Support Bracket on the Fire Wall of Car.)

Cover Mounting Bolt ⑧ on the rear of the unit with Rubber Cushion (Optional), and mount it into the existing Rear Support Bracket.

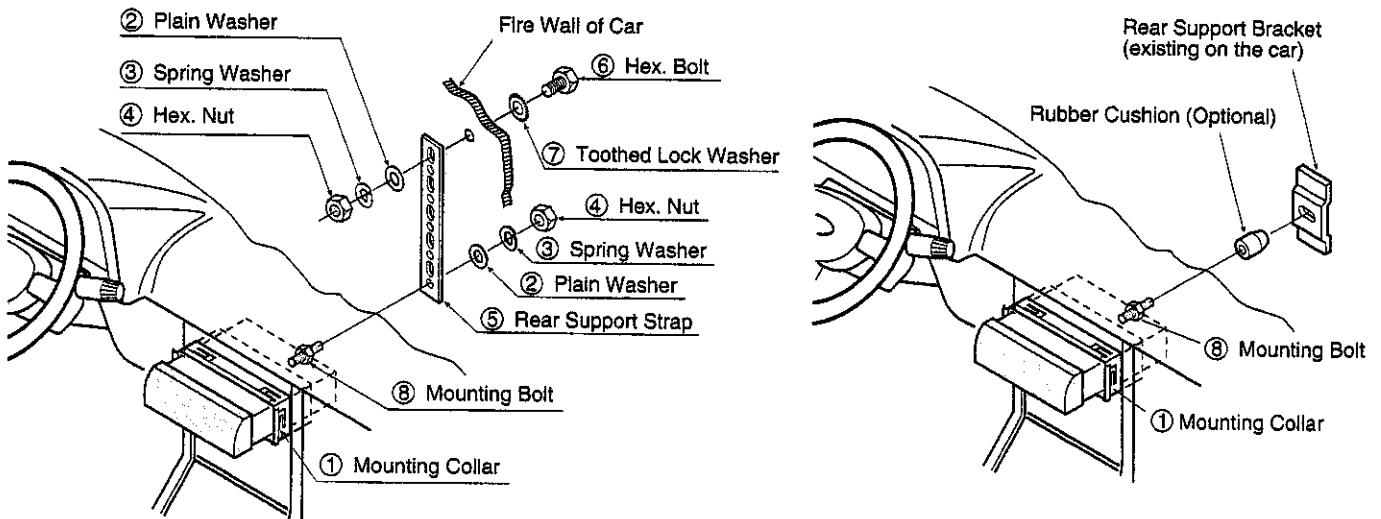

**3. Plug the Power Connector ⑨.**

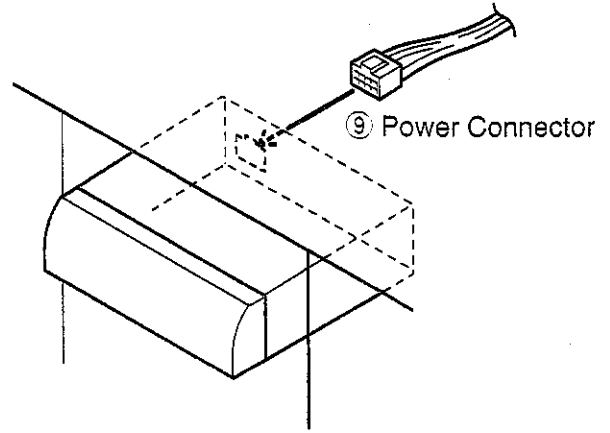

**4. After installation reconnect the negative (-) battery terminal.**

**To Remove the Unit**

- a) Remove the trim plate with a screwdriver as shown in the figure.
- b) Pull out the unit while pushing two lock levers using Screwdriver in the following order. (Fig. 1, 2)
- c) Remove the unit pulling with both hands. (Fig. 3)

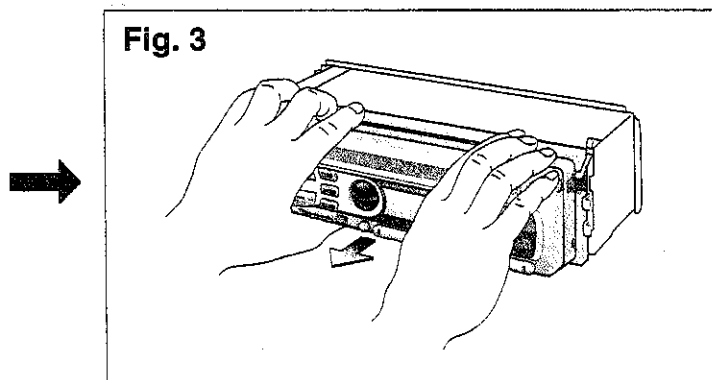
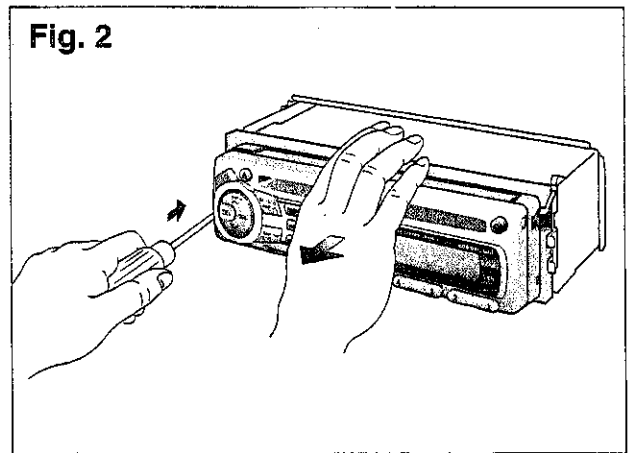
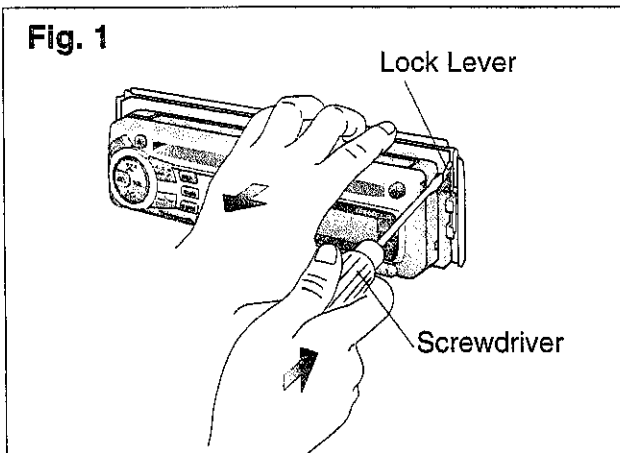
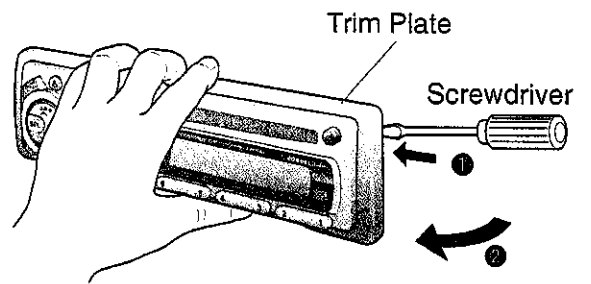

# Electrical Connection

**Caution:**

- Confirm the note on page 4, and make connections to the connectors on car side.
- To prevent damage to the unit, be sure to follow the connection diagram below.
- Remove the covering of the leads about 5 mm long from their end before connecting. (the cords except for ISO connector's cords)
- Do not insert the power connector into the unit until the wiring is completed.
- Be sure to insulate any exposed wires from a possible short-circuit from the car chassis. Bundle all cables and keep cable terminals free from touching any metal parts.

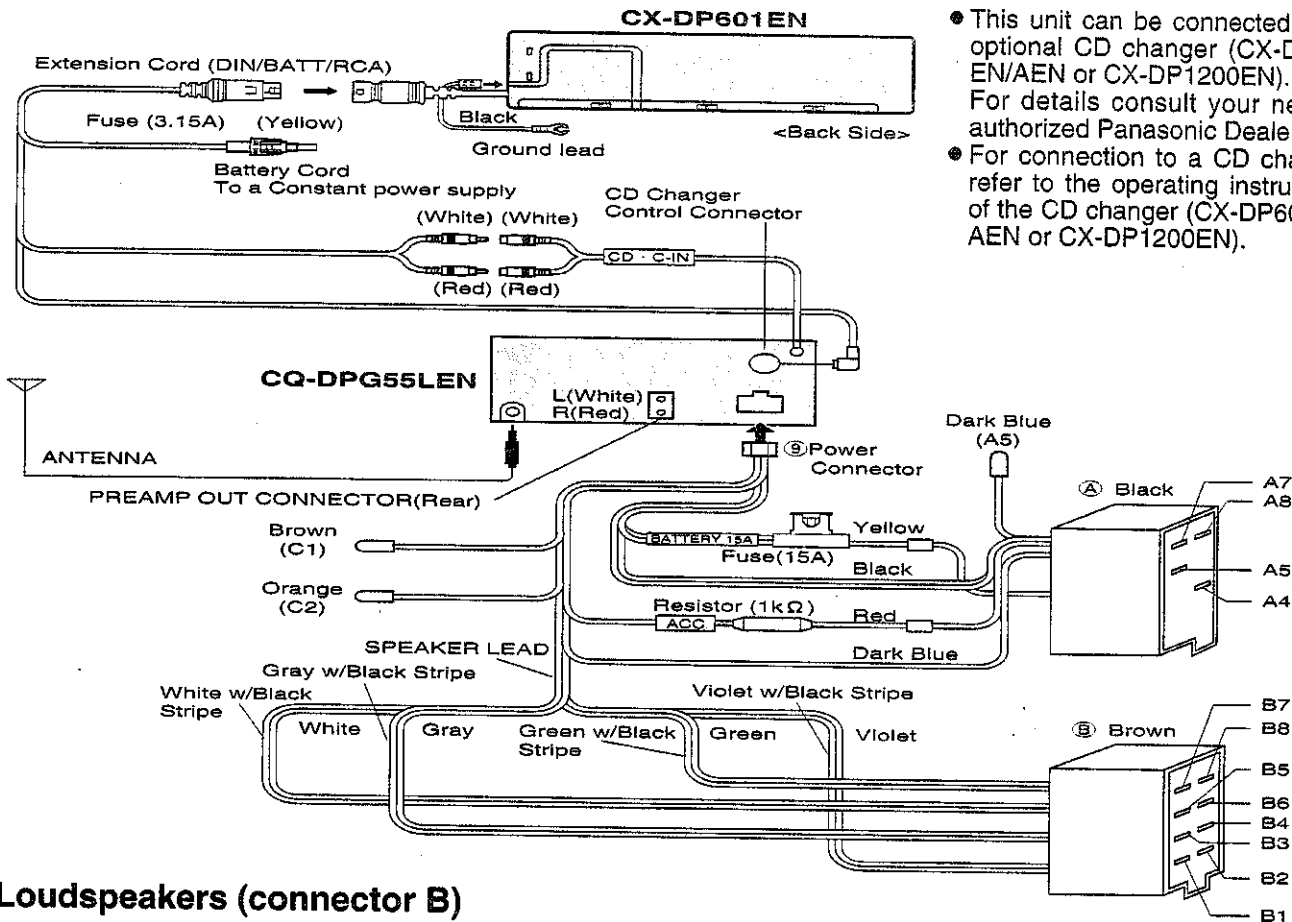

- This unit can be connected to an optional CD changer (CX-DP600 EN/AEN or CX-DP1200EN). For details consult your nearest authorized Panasonic Dealer.
- For connection to a CD changer, refer to the operating instructions of the CD changer (CX-DP600EN/AEN or CX-DP1200EN).

**Loudspeakers (connector B)**

	Left +	Left -	Right +	Right -
Front	B5 (White)	B6 (White w/Black Stripe)	B3 (Gray)	B4 (Gray w/Black Stripe)
Rear	B7 (Green)	B8 (Green w/Black Stripe)	B1 (Violet)	B2 (Violet w/Black Stripe)

**A4**  
**BATTERY LEAD** (To Battery of Car) (Yellow)  
 Connect to the "BAT" terminal on the fuse block of the car. The power should be supplied continuously to the yellow leads regardless of the on/off position of the ignition key.

**A5**  
**MOTOR ANTENNA RELAY CONTROL LEAD** (Dark Blue)  
 (To Motor Antenna) (Max. 500mA)  
 This lead is not intended for use with switch actuated power antenna.  
**AMP-RELAY CONTROL POWER LEAD**  
 This lead is for connection to Panasonic power amplifier.

**A7**  
**POWER LEAD** (Red)  
 Connect to the "radio" power line of the car or to the "IGN" or "ACC" terminal of the fuse block.

**A8**  
**GROUND LEAD** (Black)  
 Connect to a well grounded metallic part of your car.

**C1**  
 Not Used

**C2**  
**TELEPHONE MUTE LEAD** (Orange)  
 (To car telephone mute line)  
**TELEPHONE MUTE**  
 The telephone mute lead, if connected to the car telephone mute line, will activate the muting circuit and the sound from the speakers cannot be heard while the telephone conversation is in progress.  
**Note:** This telephone mute lead is for connection only to the radio mute line. Be sure to ascertain this because it will not work with other type of output system.



# Speaker Connections

**CAUTION:**

1. Use ungrounded speakers only.
2. The speakers to be used with this unit should be able to handle more than 40W of audio power. If an optional amplifier is used, the speakers should be able to handle the maximum output power of the amplifier. Use of speakers with small input ratings can cause damage to the speakers.
3. The speaker impedance should be 4 - 8 ohms. If the impedance is too large or too small, it affects the output and may cause damage to the speakers or this unit.
4. Do not use 3-wire type speaker system having a common earth lead. Never connect the speaker cord to the body of the car. This unit uses the BTCL circuit, so each speaker should be connected separately using parallel vinyl insulated cords.
5. The speaker cords and the power amplifier unit should be kept away (about 30cm apart) from the antenna and antenna extension cord.
6. Follow the connection diagram below carefully. Failure to do so may cause damage to both unit and speakers.

• Unit will be damaged if speakers (Front, Rear) are not connected properly.

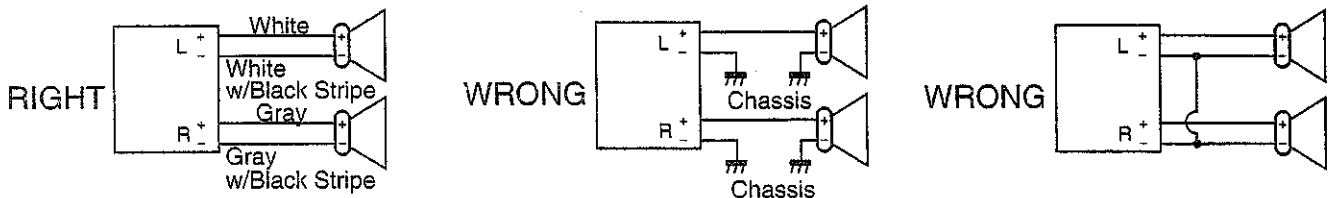

• Do not connect more than one speaker to one set of speaker leads.

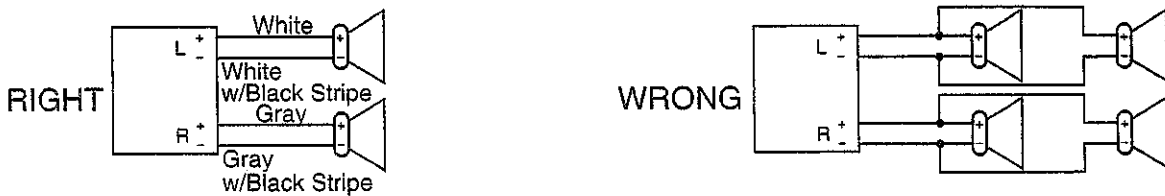

# Special Notes

## Notes on Compact Discs

**ONLY USE DISCS CARRYING LABEL SHOWN ON THE RIGHT**



- Dirt, dust, scratches and bending of disc will cause misoperation. Handle discs with care.
- Do not place stickers or make scratches on disc.
- Do not bend discs.
- Disc should always be kept in the case when not in use to prevent from damaging.
- Do not place discs in the following places:
  1. Direct sunlight;
  2. Dirty, dusty and damp areas;
  3. Near car heaters;
  4. Seats and dashboard.

### Disc Cleaning

Use a dry soft cloth to wipe the surface. If the disc is quite dirty use a soft cloth slightly dampened in isopropyl (rubbing) alcohol. Never use solvents such as benzine, thinner, conventional record cleaner, or mopper as they may mar the surface of the disc.

Label

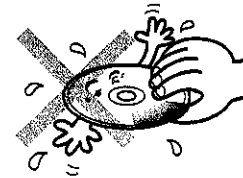
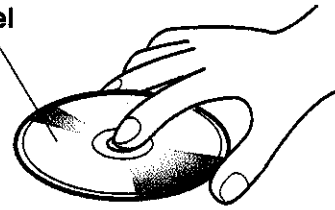

**Do not touch the underside of the disc.**

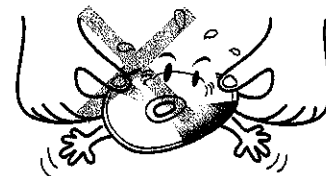

**Do not bend.**

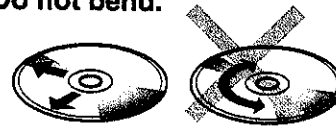

**Wipe the disc from center to outside direction.**

## Caution for use of a new Disc

A new disc may have rough edges on its inner and outer perimeter. If a disc with rough edges is used, proper setting will not be possible and the CD player will not play the disc. Therefore, remove the rough edges in advance by using a ball-point pen or pencil as shown on right. To remove the rough edges, press the side of the pen or pencil against the inner and outer perimeter of the disc.

Rough edges on outer perimeter

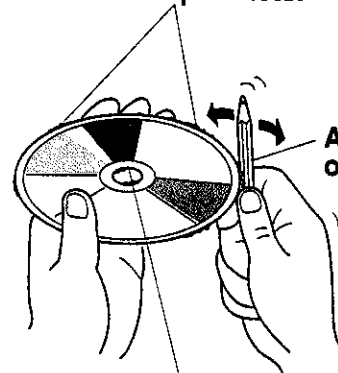

A ball-point pen or pencil

Rough edges on inner perimeter

# Fuse

Be sure to use a fuse of the specified rating (15A) when replacing a blown fuse. Fuses with higher capacity ratings, use of any substitute, or connection without a fuse may result in a fire hazard or damage to the unit. If the replacement fuse fails, consult your nearest authorized Panasonic Service Center.

# Maintenance

To clean the exterior of this unit, use a soft cloth to wipe the surface. Do not use benzene, thinner, or any other type of solvents.

# Specifications

## General

Power Supply	: DC 12V (11V - 16V), Test Voltage 14.4V, Negative Ground
Tone Controls	: Bass; $\pm 12$ dB at 100Hz Treble; $\pm 12$ dB at 10kHz
Current Consumption	: Less than 2.5A (CD mode, 0.5W 4-Speaker)
Maximum Power Output	: 40W x 4 (at 4 $\Omega$ )
Power Output	: 20W x 4 (DIN45 324, at 4 $\Omega$ )
Speaker Impedance	: 4 - 8 $\Omega$
Dimensions (Main unit)	: 178(W) x 50(H) x 150(D) mm
Weight (Main unit)	: 1.6 kg

## FM Stereo Radio

Frequency Range	: 87.5 - 108MHz
Usable Sensitivity	: 6dB/ $\mu$ V(S/N 30dB)
Stereo Separation	: 35 dB(at 1kHz)

## MW Radio

Frequency Range	: 531 - 1,602kHz
Usable Sensitivity	: 28dB/ $\mu$ V (S/N 20dB)

## LW Radio

Frequency Range	: 153 - 279kHz
Usable Sensitivity	: 32dB/ $\mu$ V (S/N 20dB)

## CD Player

Sampling Frequency	: 32 times oversampling
DA Converter	: MASH•1bit/4 DAC System
Error Correction System	: Panasonic Super Decoding Algorithm
Pick-Up Type	: 1-beam
Light Source	: Semiconductor laser
Wavelength	: 780 nm
Frequency Response	: 20 Hz - 20,000 Hz ( $\pm 1$ dB)
Signal to Noise Ratio	: 98 dB
Total Harmonic Distortion	: 0.01%(1 kHz)
Wow and Flutter	: Below measurable limits
Channel Separation	: 75 dB

**Note:**

Specifications and the design are subject to possible modification without notice due to improvements.