

Operating Instructions

操作說明書

INTEGRATED CD/CASSETTE RECEIVER WITH DSP
收音／CD／放音組合機

CQ-VX777EW

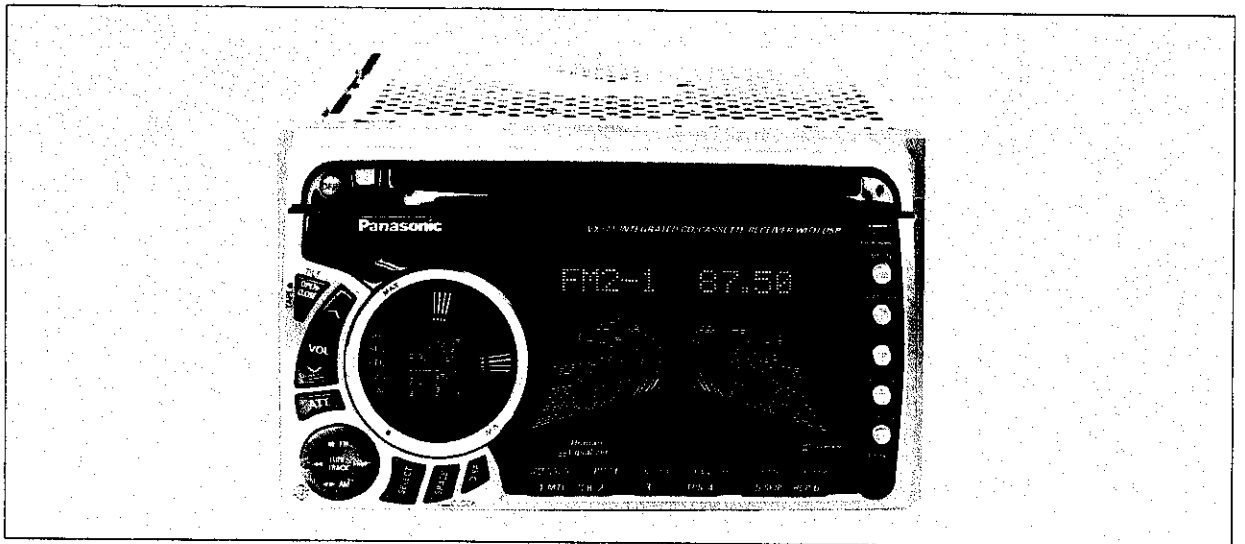

Panasonic[®]
松下電器

Before operating this set, please read these instructions completely.
操作本裝置之前，請熟讀這些說明。

Contents

	Page		Page
Precaution.....	3	AUX IN OPERATION.....	35
DISPLAY: GENERAL.....	4	MD IN DISPLAY.....	36
OPERATION: GENERAL.....	5	MD IN OPERATION.....	36
DISPLAY: TUNER (RADIO).....	18	USEFUL FUNCTIONS.....	37
LISTENING TO THE RADIO.....	19	CLOCK DISPLAY.....	38
CASSETTE DECK OPERATION.....	23	CLOCK OPERATION.....	39
CD PLAYER DISPLAY.....	27	REMOTE CONTROL OPERATION.....	40
CD PLAYER OPERATION.....	28	Installation Guide.....	45
CD/MD CHANGER CONTROL		Electrical Connection.....	46
DISPLAY.....	31	Troubleshooting.....	49
CD/MD CHANGER CONTROL		Special Notes.....	50
OPERATION.....	32	Specifications.....	52
AUX IN DISPLAY.....	35		

目錄

	頁		頁
預防措施.....	53	小型鐳射唱片收音機輸入的顯示.....	86
顯示屏：整體.....	54	小型鐳射唱片收音機輸入的操作.....	86
操作：整體.....	55	方便的功能.....	87
顯示：調諧器（收音機）.....	68	時鐘的顯示.....	88
收聽收音機節目.....	69	時鐘的操作.....	89
磁帶收音機的操作.....	73	遙控器的操作.....	90
鐳射唱片收音機的顯示.....	77	安裝指南.....	95
鐳射唱片收音機的操作.....	78	電氣連接.....	96
鐳射唱片/小型鐳射唱片換片器控制的顯示 ..	81	故障排除.....	99
鐳射唱片/小型鐳射唱片換片器控制的操作 ..	82	特殊注意事項.....	100
外部輸入的顯示.....	85	規格.....	102
外部輸入的操作.....	85		

Panasonic welcomes you to their constantly growing family of electronic products owners. We endeavor to give you the advantages of precise electronic and mechanical engineering, manufacturing with carefully selected components, and assembly by people who are proud of the reputation their work has produced for our company. We know this product will bring you many hours of enjoyment, and after you discover the quality, value, and reliability we have built into it, you too will be proud to be a member of our family.

Precautions

Volume Level

For your driving safety, keep the volume level low enough to be aware of road and traffic conditions.

Car Washing

To avoid electrical short circuits which may cause fire or other damage, do not expose this equipment (including the speakers, CDs or tapes) to water or excessive moisture.

Car Ventilation

If your car is parked for several hours in direct sunlight, the temperature inside the car may become very high. It is advisable to drive the car for a while until the interior cools down before switching the unit on.

Power Supply

This equipment is designed to be used in a car that has a 12-volt negative ground battery system.

Tape Mechanism

Keep magnets, screwdrivers and other metallic objects away from the tape mechanism and tape head.

Disc Mechanism

Do not insert coins or any small objects. Keep screwdrivers and other metallic objects away from the disc mechanism and disc.

Service

This unit is made of precision parts. Do not attempt to disassemble or adjust any parts. For repair, please consult your nearest authorized Panasonic Service Center.

About Preset Memory

The present memory settings are cleared and return to the original factory settings when the power connector or battery is disconnected.

DISPLAY: GENERAL

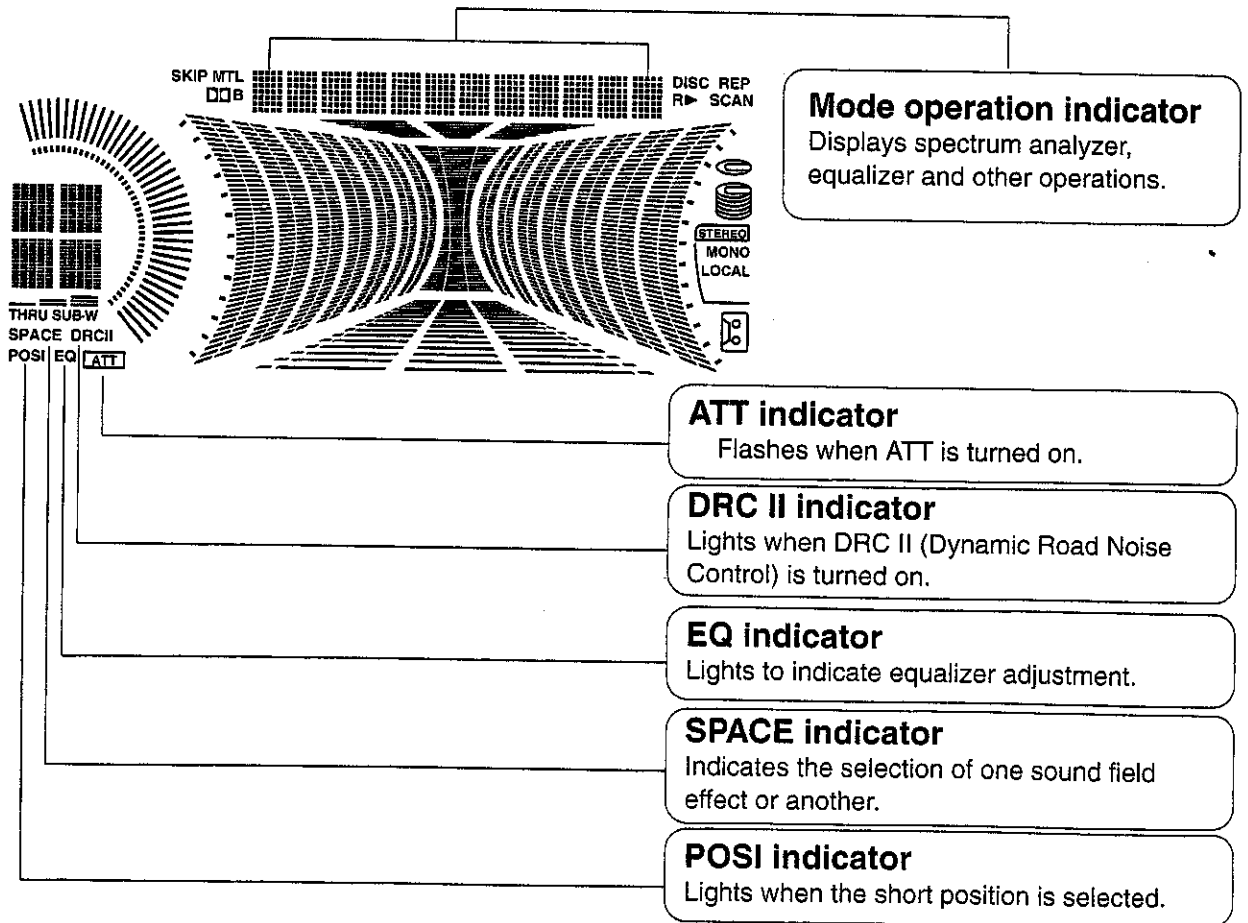
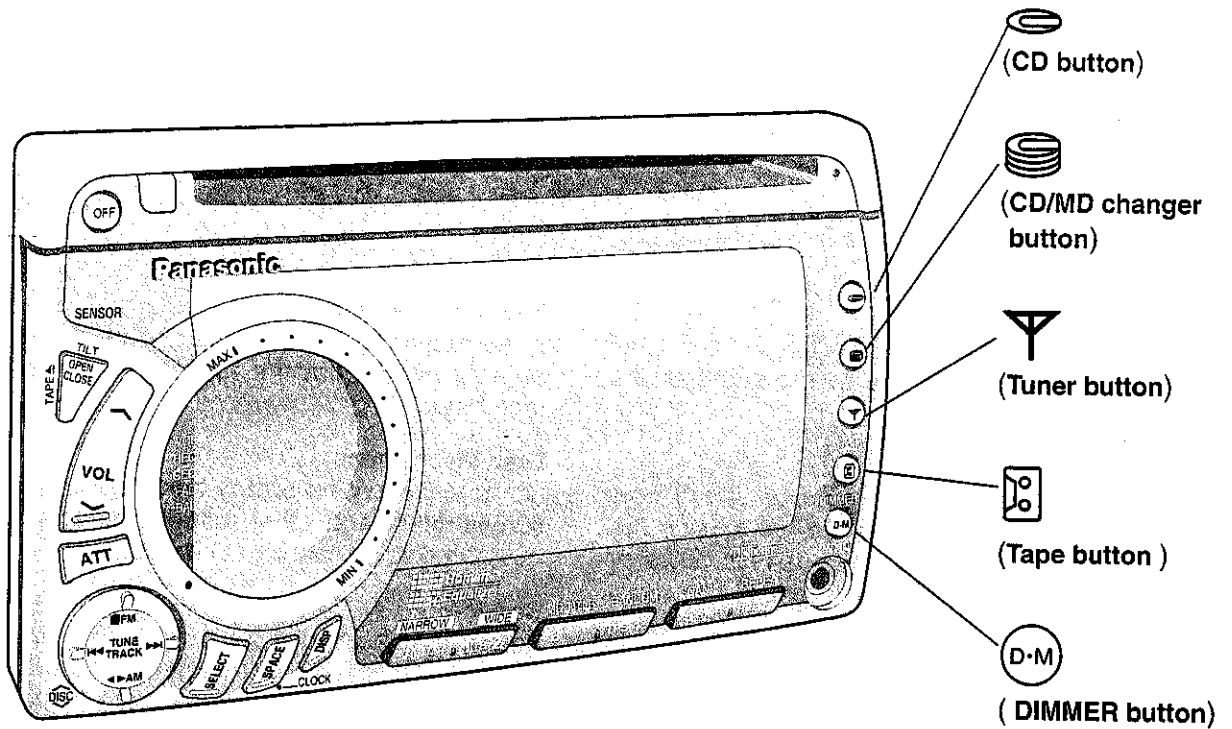

OPERATION: GENERAL

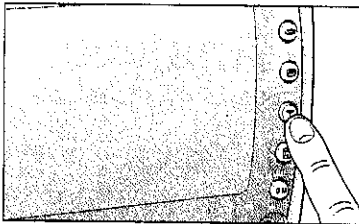
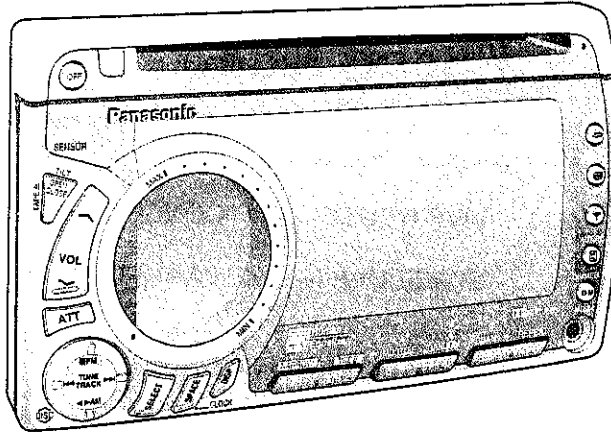

Starting Operation/Power

- ① Turn the ACC switch of your car to ON.
- ② When any of Υ ((TUNER), \ominus (CD), CH.C), TAPE , or DIM (DIMMER) is pressed, your Panasonic set is switched on.

Note:

When you are using your Panasonic set for the first time, the demonstration mode pattern is displayed. The display may remain unchanged when the above buttons are pressed. In such a case, press DISP to release demonstration mode.

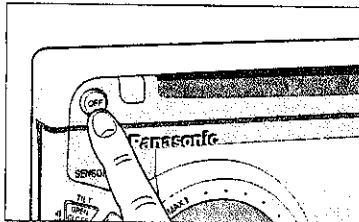

- ③ When OFF is pressed, your Panasonic set is switched off to return to clock display mode. (See page 39 when clock display is selected.)

The clock display goes out when OFF is pressed again.

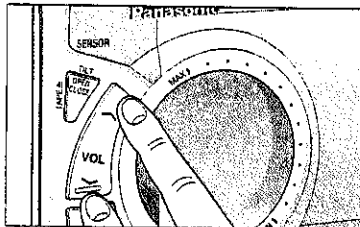

Volume Control

Use the \wedge and \vee buttons to adjust the volume.

The volume increases when the \wedge button is pressed.

The volume decreases when the \vee button is pressed. 0 to 40

Volume 24

Note:

The volume can be adjusted in each operation mode.

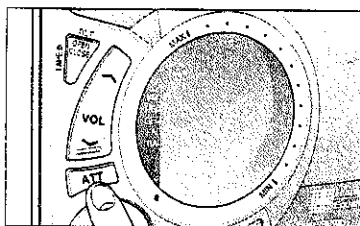

ATT

When ATT is pressed, the volume decreases instantaneously to about 1/10 of the present level.

ATT

To restore to the preceding level, press ATT again.

OPERATION: GENERAL (Continued)

Switching Space (Sound Field Effect) Mode

Sound field effects change as shown below each time SPACE is pressed. (See page 8.)

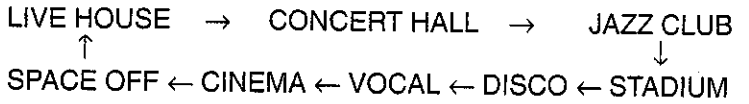
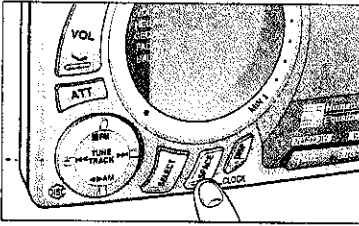

(It is also possible to widen or narrow the sound field.) (See page 8.)

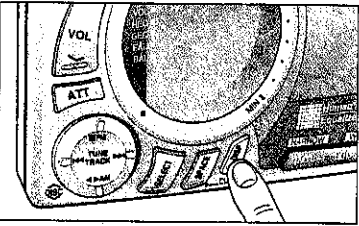

Switching Spectrum Analyzer

16 patterns, including that of demonstration mode, are displayed by turn each time DISP is pressed.

If you wish to select demonstration mode, press DISP.

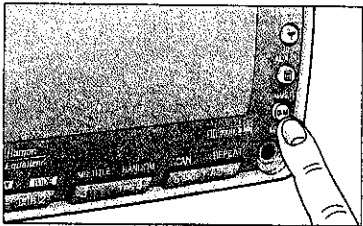

Switching Dimmer

Dimmer level changes in the following order each time  (DIMMER) is pressed.

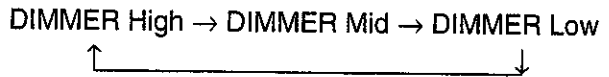

The dimmer can also be adjusted by turning on or off the clearance lights of the car.

Initial settings are: ON → Mid
OFF → High

The illumination can also be turned by means of the clearance lights of the car.

Equalizer Display

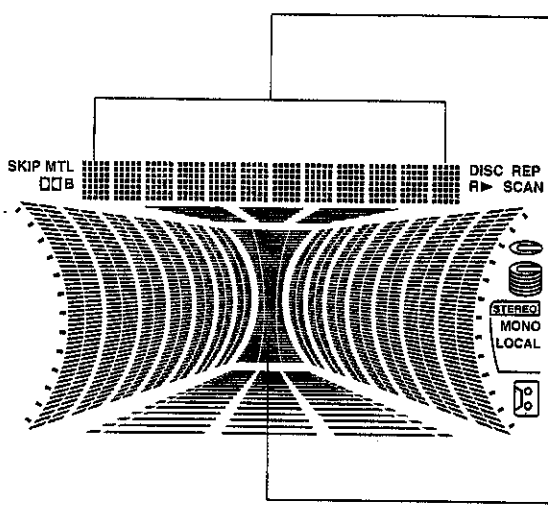

HEQ (Human equalizer)
GEQ (Graphic equalizer)
Display of Settings
HEQ : Set state is displayed.
GEQ : Set frequency is displayed.
(Preset channels are displayed if they are set in the memory.)

Cursor
HEQ : The HEQ set position is displayed in the left half and the equalizer characteristics are displayed in the right half.
GEQ : The equalizer characteristics are displayed on the screen.

OPERATION: GENERAL (Continued)

Note:

Never adjust tone quality while driving. This is important for safety.

Tone Quality Adjustment

Tone quantity changes as shown below each time SELECT is pressed.

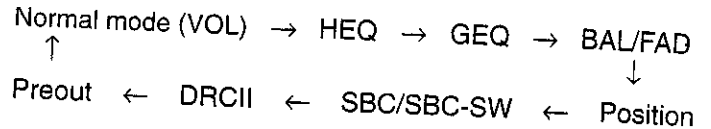

HEQ Setting

- ① Press SELECT to select HEQ. The EQ indicator blinks.
- ② Press ◀◀, ▶▶, ■ or ◀▶ to select the desired tone quality. With the center fixed flat, any of the 49 equalizer patterns, arranged in vertical and horizontal directions, can be selected.
Center : HEQ flat
 - ■ : Press to choose heavy bass sound (steps 1 to 3).
 - ◀▶ : Press to choose light bass sound (steps 1 to 3).
 - ▶▶ : Press to choose sharp treble sound (steps 1 to 3).
 - ◀◀ : Press to choose soft treble sound (steps 1 to 3).
- ③ Press SPACE to select a desired sound field effect.
- ④ 1. Press 1 to narrow the sound field (steps 1 to 3).
2. Press 2 to widen the sound field (steps 1 to 3).

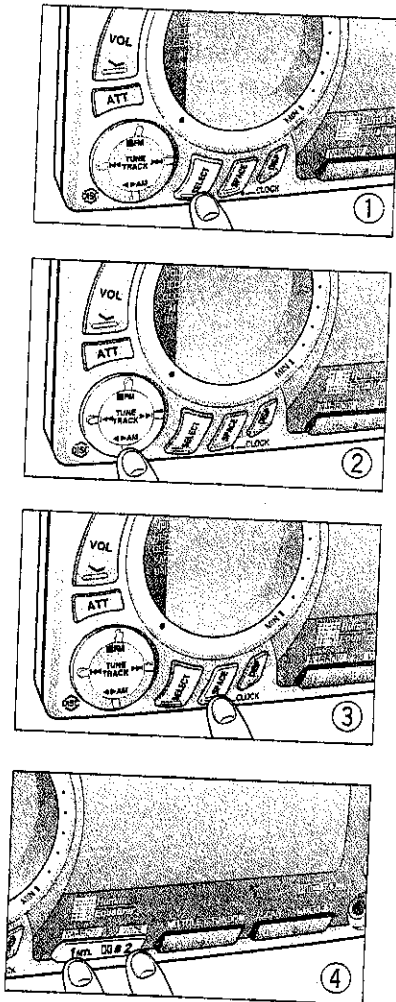

Note :

If WIDE is set after selecting HALL by pressing SPACE, the space effect of a larger hall can be obtained. If NARROW is set, the space effect of a smaller hall is produced. You will be able to create a pleasing sound space by selecting a HEQ pattern to suit your liking as described on page 12.

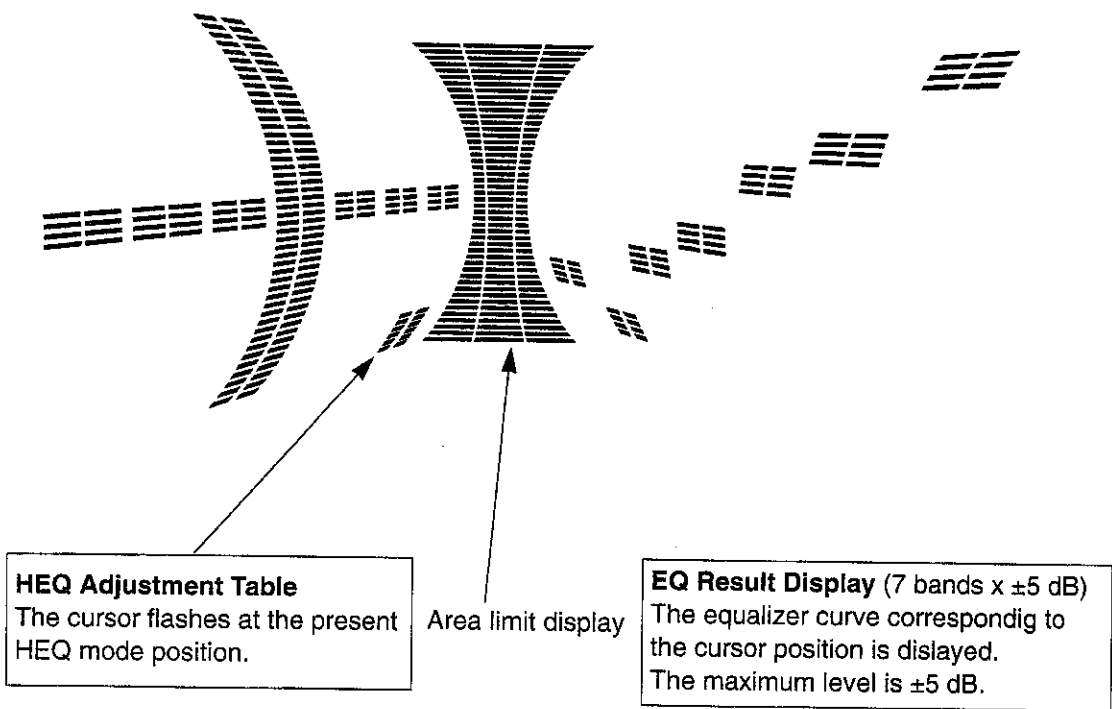

Note:
Different from GEQ which is for adjusting the tone quality of each frequency band, HEQ is a revolutionary equalizer which permits selection of your desired tone quality: heavy, light, sharp, or soft. The space function enables you to adjust the space of your car to create a sound field better pleasing to you.

OPERATION: GENERAL (Continued)

The HEQ matrix display is as shown below.

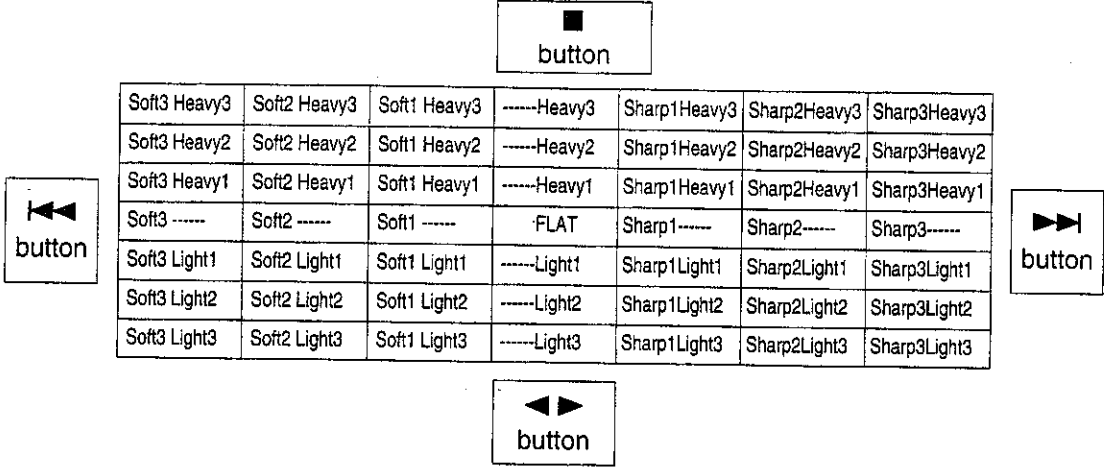

Human Equalizer Position Image

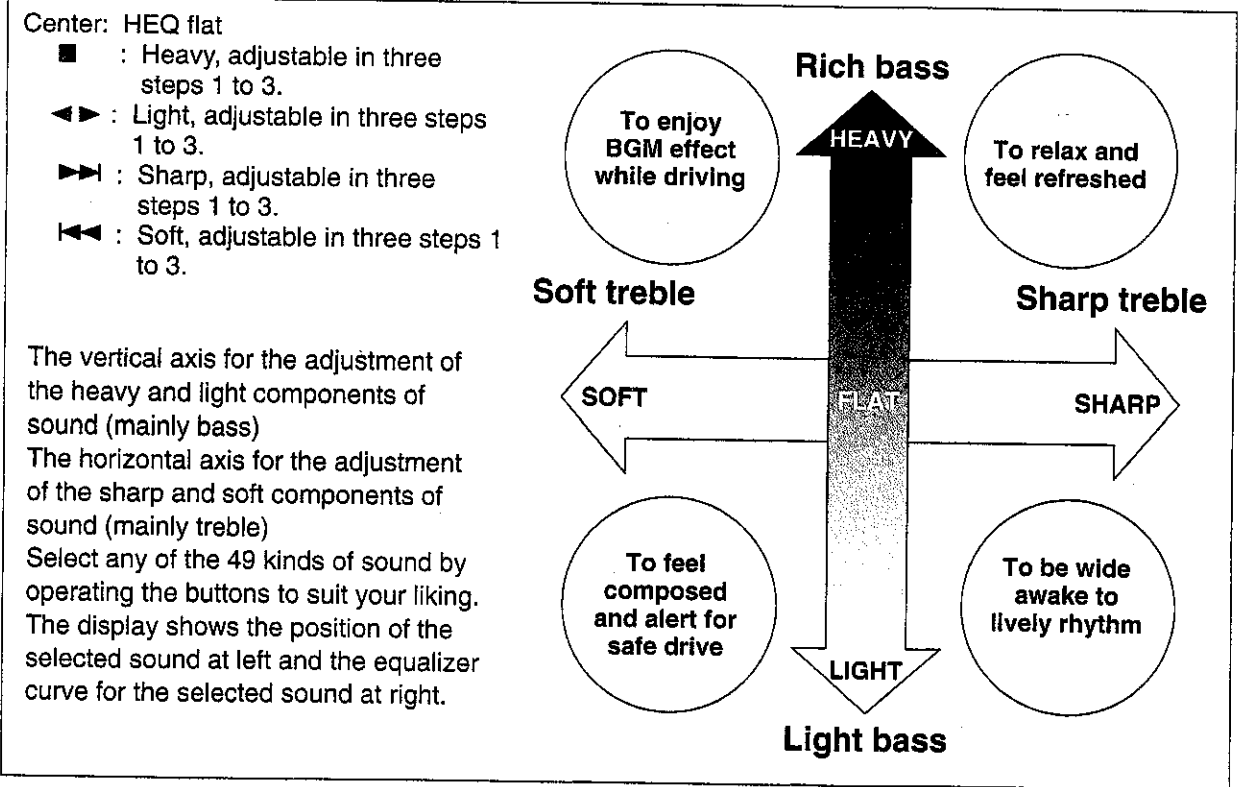

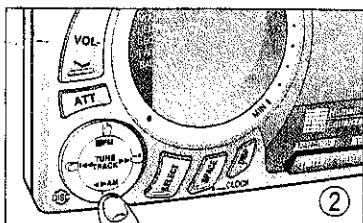
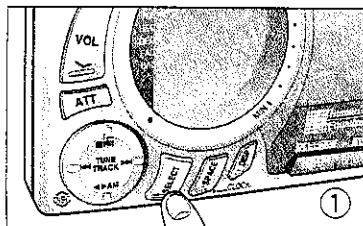

Setting GEQ

- ① Press SELECT to select GEQ mode.
- ② ● Press ►►, ◀◀ (frequency selection buttons) to select a frequency.
Any of the seven frequency bands (80 Hz, 160 Hz, 320 Hz, 640 Hz, 1.6 kHz, 4 kHz, 10 kHz) can be selected. The flashing cursor moves to the left or right each time the corresponding button is pressed.
The flashing cursor move leftward (bass) when ◀◀ is pressed.
The flashing cursor move rightward (treble) when ►► is pressed.
Move the flashing cursor to the frequency position you wish to adjust.
- Press ■, ◀► to adjust the level.
0 dB when the cursor is at the center. Any of the 13 levels can be selected from +12 dB (cursor at the highest position) to -12 dB (cursor at the lowest position).
Press ■ to raise the level.
Press ◀► to lower the level.

Note:

Make the above adjustment while the mode is displayed (for about 5 seconds). If no button is pressed while it is displayed, it automatically returns to normal mode. In such a case, press SELECT again to select GEQ.

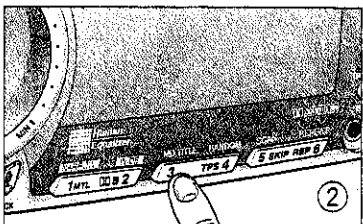
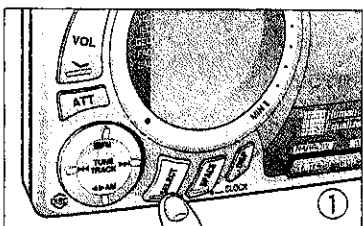

GEQ in the Memory

- ① Press SELECT to select GEQ mode.
- ② Press the preset button (1 to 6) you wish to save in the memory.
- ③ Set the desired GEQ.

Note:

If a preset button once saved in the memory is preset again, the GEQ saved in the memory is erased.

OPERATION: GENERAL (Continued)

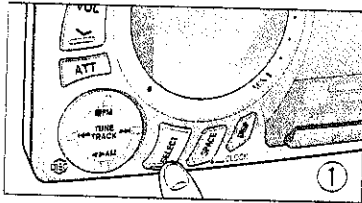

Recalling GEQ

- ① Press SELECT to select GEQ mode.
- ② Press one of the buttons (1 to 6) to recall the desired GEQ. The GEQ preset display appears.

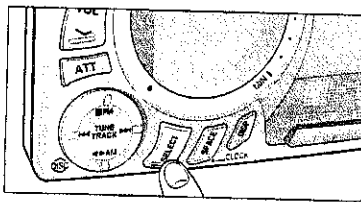
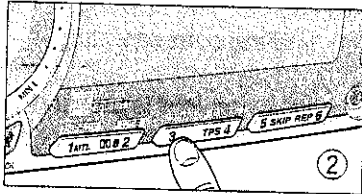

Balance and Fader Adjustment

Press SELECT to select BAL/FAD.

BAL Adjustment

Press ►► to increase the sound volume from the right speaker.

Press ◄◄ to increase the sound volume from the left speaker.

FAD Adjustment

Press ■ to increase the volume from the front speaker.

Press ◄► to increase the volume from the rear speaker.

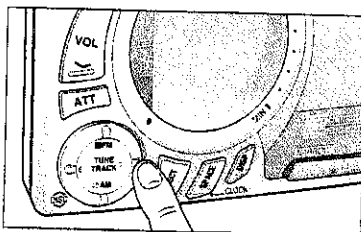
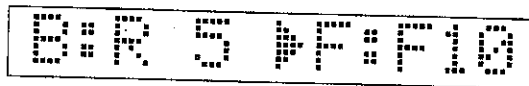
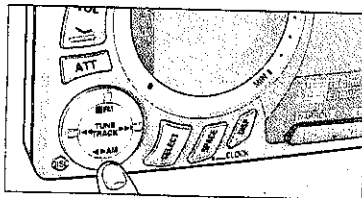

Selecting Short Position

The short position function reproduces a sound image ideal to the listener according to his or her place in the car.

- ① Press SELECT to select POSITION mode.
- ② The positions change as shown below each time ►► is pressed. (The direction of change will be reversed if ◄◄ is pressed.)

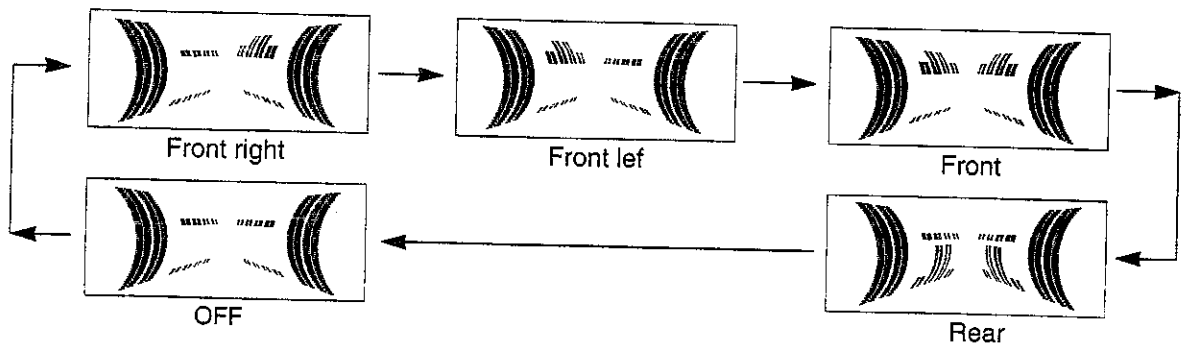

Select your desired position. Default: OFF

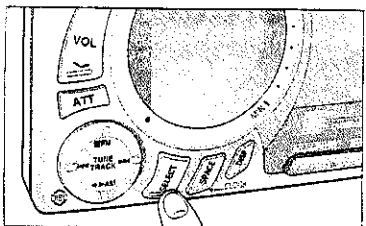

SBC (Super Bass Control)

- ① Press SELECT to select SBC mode.
- ② ● Press ■ to set SBC.
The SBC types change as shown below each time ►► is pressed.

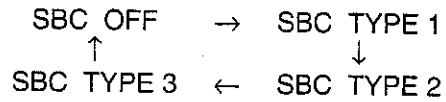

(The direction of change will be reversed if ◀◀ is pressed.)

- Press ◀► to select SBC-SW. (In this case, the rear speaker will be in monaural mode.)
The SWC frequencies change as shown below each time ►► is pressed.

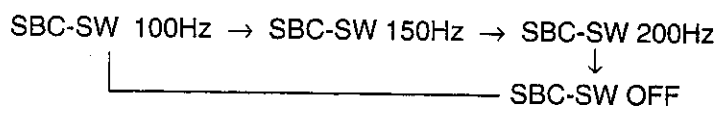

(The direction of change will be reversed if ◀◀ is pressed.)

The SBC function reinforces the bass range to suit the speaker characteristics. It is set to the rear speaker output, and permits selection of any of the three positions depending on the type of speakers installed. (See the tables below.) These characteristics are so set as to be best suited particularly to the recommended speakers, but are subject to change in acoustic effects depending on the type of car and the position of speaker installation. Referring to the characteristics of each type of speaker, set SBC as suited to the characteristics of the type of speakers used. In case of the SBC-SW type, the system can be upgraded by connecting a desired subwoofer to the special subwoofer output to create a front-oriented sound.

SBC Display	Speaker Assumed
SBC TYPE1	Semi-flush mounted speaker
SBC TYPE2	
SBC TYPE3	Flush mounted speaker

SBC-SW Display	Bass Cutoff Frequency
SBC-SW 100Hz	100Hz
SBC-SW 150Hz	150Hz
SBC-SW 200Hz	200Hz

OPERATION: GENERAL (Continued)

DRC II (Dynamic Road Noise Control) Operation

The DRC II function corrects noise inside the car as appropriate to the running condition of it to let you enjoy listening.

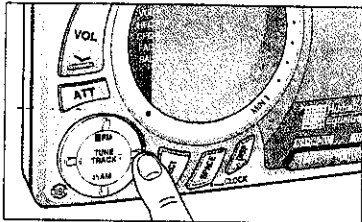

DRC II Operation

- ① Press SELECT to select DRC II mode.
- ② DRC II types change as shown below each time **▶▶** is pressed.

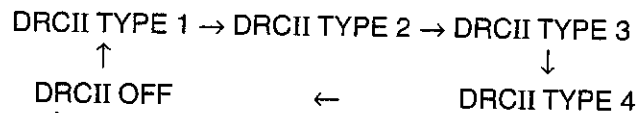

(The direction of change will be reversed if **◀◀** is pressed.)

Note:

Your set is originally set to DRC II TYPE 2.

The correction level increases starting with TYPE 1. Select a position as desired referring to the table below.

Model	Description	Characteristics
TYPE1	Town drive	DRC curve ①, compressor OFF
TYPE2	Highway drive	DRC curve ②, compressor OFF
TYPE3	Music in low volume in town drive	DRC curve ①, compressor ON
TYPE4	Music in low volume in highway drive	DRC curve ②, compress ON

The DRC II curve changes in the pattern ① or ② as follows:

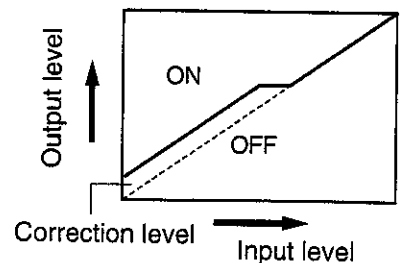
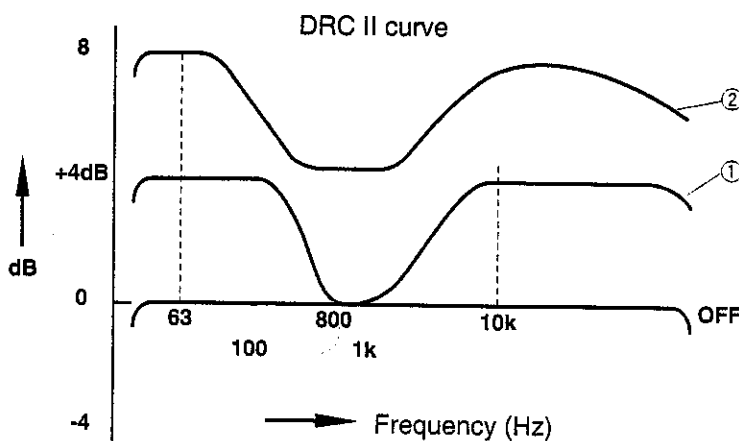

The compressor corrects low-level music signals to a level for easy listening.

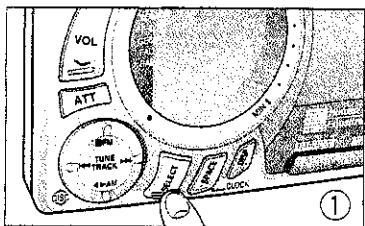

Switching Front Preamplifier Through Output/Subwoofer Output

- ① Press SELECT to change to Preout.
- ② Press **■** to select Through Output (THRU displayed). Press **◀▶** to select Subwoofer Output (SUB.W displayed). Press **▶▶** to raise the preamplifier output volume (4 steps). Press **◀◀** to lower the preamplifier output volume (4 steps).
<Preamplifier output volume indications>

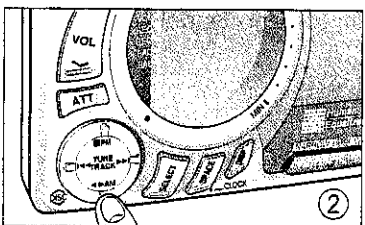

Note:

- The output volume of the built-in amplifier is constant, so the volume will remain unchanged except for a system in which an external amplifier is connected to the front amplifier output.
- If the fader is set to the rear position, the output volume of the front preamplifier will decrease.

OPERATION: GENERAL (Continued)

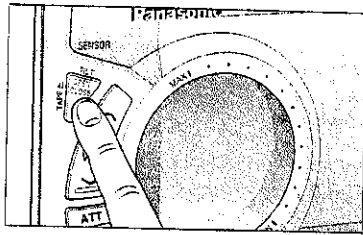

Opening/Closing the Front Panel (Liftup)

Open and close the front panel when inserting or removing a tape.

- When OPEN CLOSE is pressed, the front panel is lifted all the way up.
If a tape is inside, it will be automatically ejected.
- When OPEN CLOSE is pressed again, the front panel is lowered all the way down to the original position.

Note:

- If a tape is inserted when the front panel is up highest, the panel is automatically lowered all the way down to the original position.
- When the front panel is up highest, no operation will be accepted except for OPEN CLOSE and the remote control buttons.
- If no cassette tape is inserted or ejected for about 25 seconds while the front panel is up highest, the panel is automatically lowered all the way down to the original position.
- If a CD or tape is not in the fully ejected position, loading or unloading must be accurately performed because, otherwise, the CD, tape or the front panel is subject to damage.

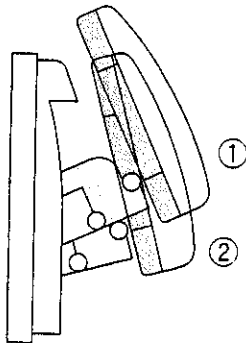

- ① : FULL OPEN
- ② : HALF OPEN

Note:

- The highest liftup position of the front panel can be set to either of the two positions as shown at left.
- If there is no obstacle in the car, the front panel can be set to position ① (FULL OPEN).
- The front panel is originally set to position ② (HALF OPEN).
- See page 37 for how to set the front panel liftup position.

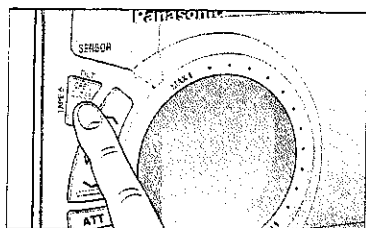

Front Panel Angle Adjustment (Tilt)

The front panel can be adjusted to a desired angle for easy display viewing or easy button operation.

The front panel angle changes in 3 steps each time TILT is pressed for more than 0.5 second as shown at left.

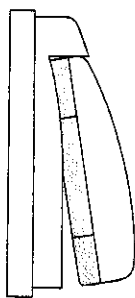

(Example for angle adjustment)

Note:

- When the engine key is turned off, the front panel is automatically fully closed.
- If a CD is ejected after adjusting the front panel angle, the front panel becomes fully closed once to make it easy to remove the CD.
- After changing or ejecting a CD, the front panel automatically returns to the preset position.
- If a button on the front panel, for example, is pressed hard after adjusting the front panel angle, the front panel goes down. Then, it automatically returns to the original position.

Caution:

- Never put your hand or finger inside while the front panel is opening or closing. This is important to avoid injuries.
- Never push or pull the front panel, or otherwise expose it to shock while it is opening or closing, or when it is up highest. This is important to avoid trouble.
- Do not place anything on the front panel while it is opening or closing, or when it is up highest.

DISPLAY: TUNER (RADIO)

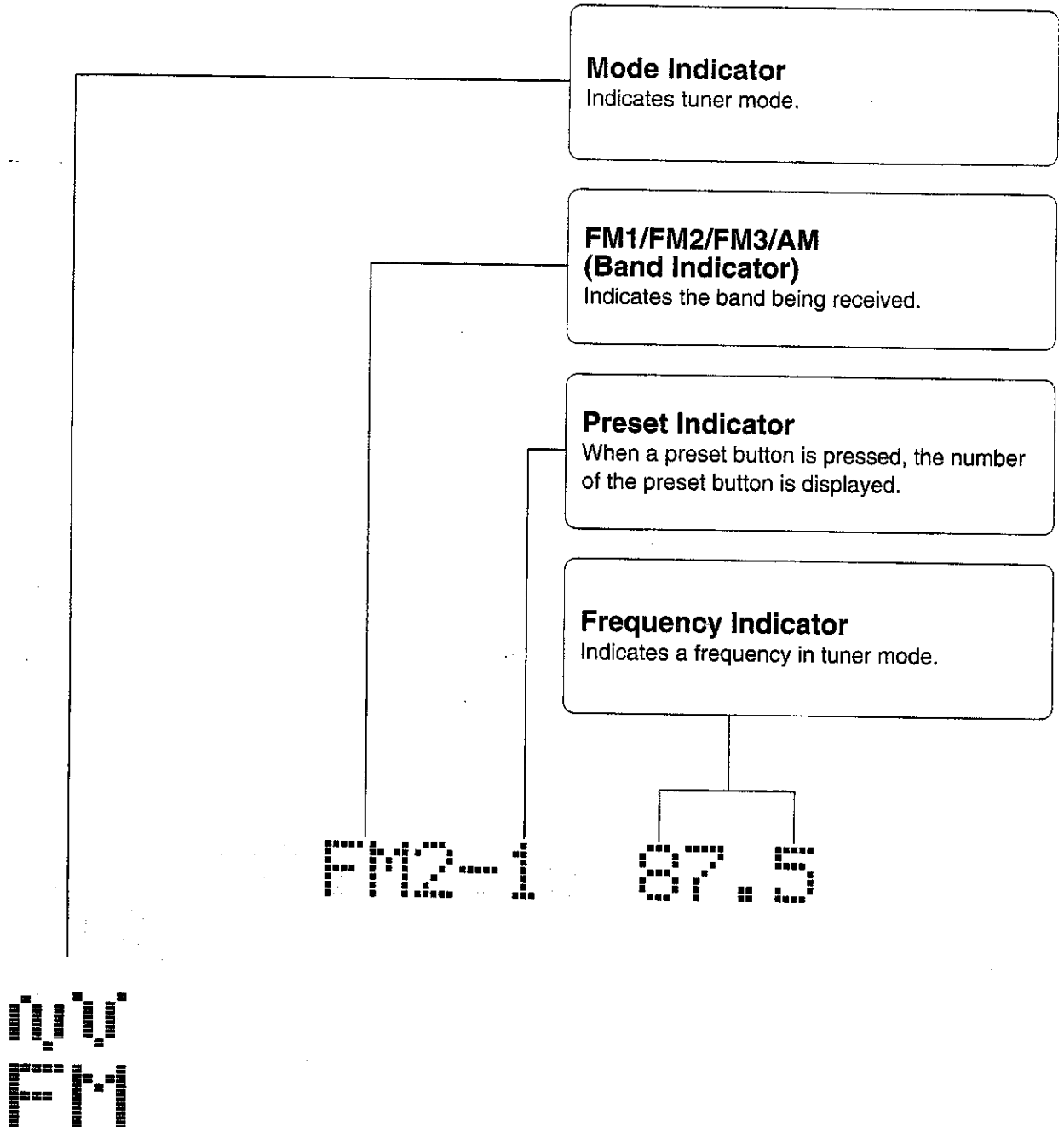

LISTENING TO THE RADIO

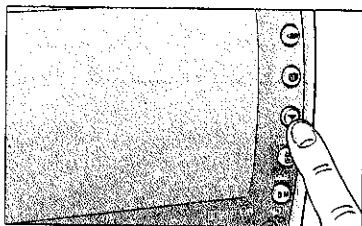
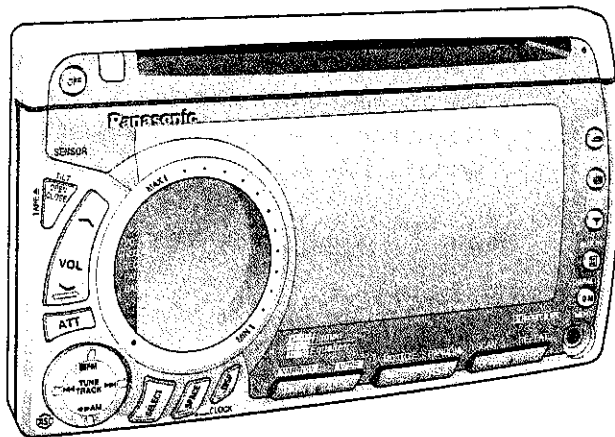

Selecting Tuner Mode

When the current mode is other than tuner mode, it can be changed to tuner mode by pressing **TUNER**.

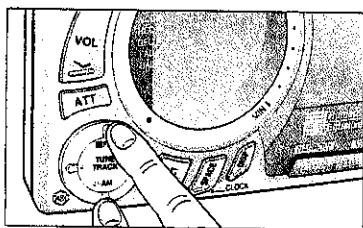

Switching Bands

- Press FM to select the bands in the following order:

FM1 → FM2 → FM3



"STEREO" indicator lights if the station is broadcasting in stereo.

- Press AM to select the band.

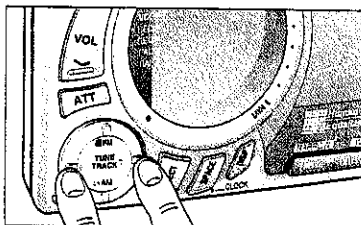

Manual Tuning

Press TUNE **▶▶** to raise the frequency.
Press **◀◀** TUNE to lower the frequency.

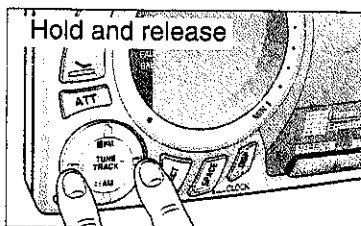

Automatic Seek Tuning

Press TUNE **▶▶** for more than 0.5 second to raise the frequency.
When it is released, the tuning automatically stops at a point where a station is tuned in to.

Press **◀◀** TUNE for more than 0.5 second to lower the frequency.
When it is released, the tuning automatically stops at a point where a station is tuned in to.

LISTENING TO THE RADIO (Continued)

MONO/LOCAL Selection

- Much interference is reduced during a weak FM stereo broadcasts when MONO is ON. (Only for FM mode).
- Searching stops automatically at a strong wave station only when LOCAL is ON.

Press  (MONO/LOCAL) to switch the mode in the following order.

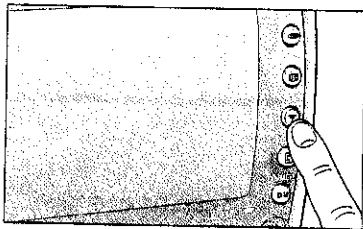

① During FM broadcasts.

Press  to switch the mode in the following order. Release your finger at the desired mode.

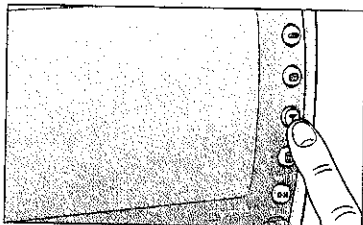
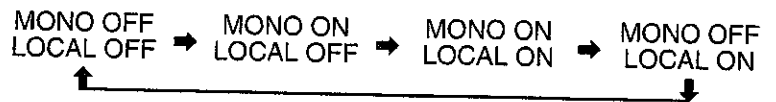

② During AM broadcasts.

Press  to switch on or off the LOCAL mode as follows.

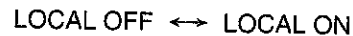

Preset Memory (Station Memory)

Up to 24 stations can be preset in the station memory as shown below.

FM1	FM2	FM3	AM
6 stations maximum	6 stations maximum	6 stations maximum	6 stations maximum

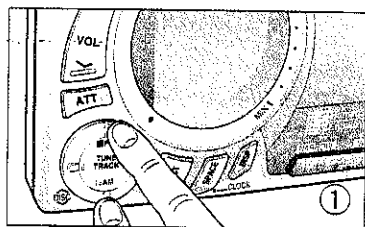

① **Band Switching**

Press FM or AM to select the desired band.

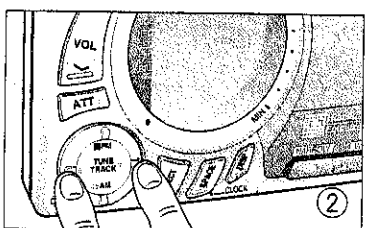

② **Station Selection**

Press TUNE ►► or ◄◄ TUNE to tune in to the desired station.

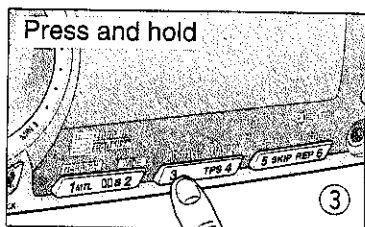

③ **Preset Button Memory**

Press any of 1 to 6 (preset) buttons to choose in the station preset by the above steps ① to ②. It indicates that the preset station has been stored in the memory. You may repeat the same operation to preset stations on the bands FM1 to AM.

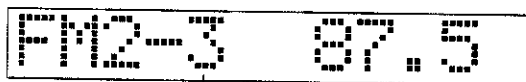

Preset number

Preset Station Tuning

When the button for a preset station stored in the memory by taking steps ① to ③ above is pressed, the preset station is tuned in to.

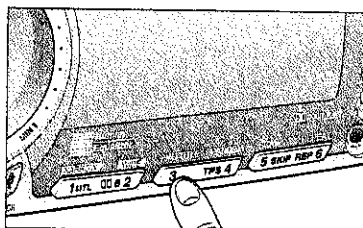

Note:

If the preset or auto preset operation is repeated on a preset button already stored in the memory, the corresponding station will be canceled from the memory.

LISTENING TO THE RADIO (Continued)

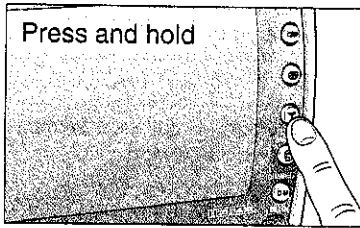

Auto Preset Memory

When **TUNER** is pressed for more than 2 seconds, search starts with the lowest frequency of the band being received and stations are automatically preset to buttons 1 to 6 in the order of signal intensity.

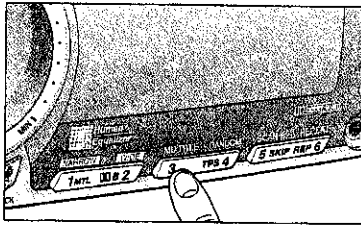

After auto preset memory, the preset stations stored in the memory are received in the order of storage for 5 seconds each.

If you find a station you wish to listen to, press the corresponding button among buttons 1 to 6.

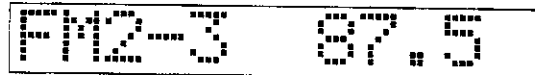

CASSETTE DECK OPERATION

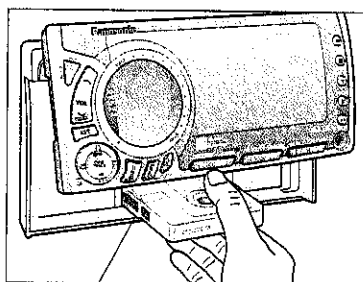
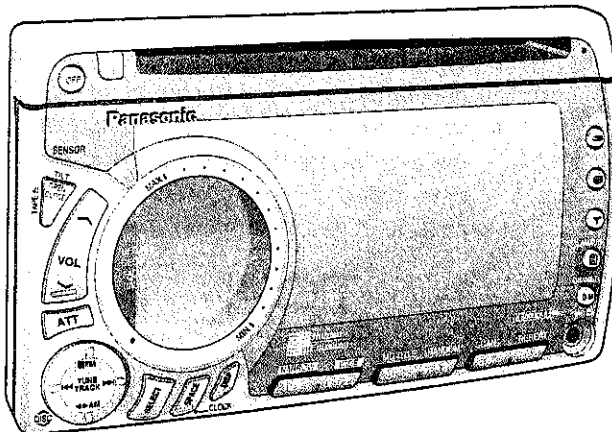

Insert a cassette with the exposed tape side on the left.

Inserting a Cassette Tape

- ① Press OPEN CLOSE to open the front panel. (See page 16.)
- ② Insert a cassette with the exposed tape side on the left. Tape mode is automatically selected to start playing the tape. If a cassette is inserted when power is off, power is automatically switched on.

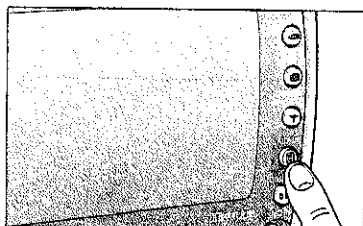

Selecting Tape Mode

If  (TAPE) is pressed in other than tape mode when a cassette is already inside, Cassette tape mode is automatically selected to start playing the tape.

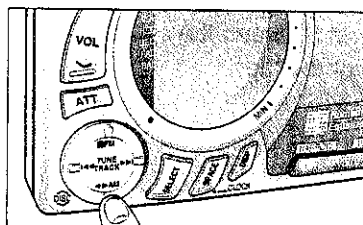

Changing Tape Sides

Press  to change one Cassette tape side to the other and the playing side is displayed.

- ▶ PLAY ▶ to play the top side
- ◀ PLAY ◀ to play the bottom side

When the tape comes to the end, the playing side is automatically changed to the other. (Auto reverse system)



CASSETTE DECK OPERATION (Continued)

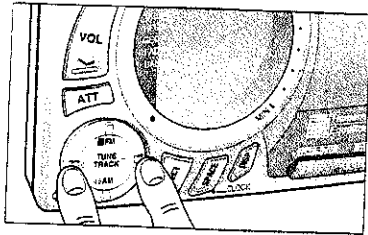

Rewind and Fast Forward

- When ◀◀ is pressed, the tape is rewound till it reaches the head end, where the tape begins to automatically play back.
- When ▶▶ is pressed, the tape is wound fast forward till it reaches the end, where the tape begins to automatically play back on the other side.

Press ■ to stop a tape being rewound or wound fast forward.

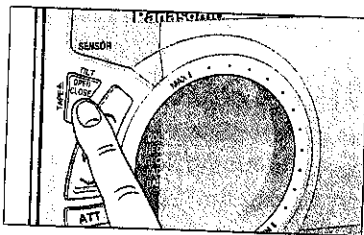
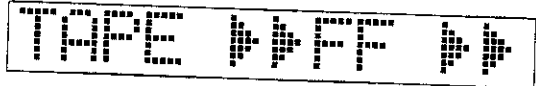

Ejecting the Tape

Press OPEN/CLOSE to eject the Cassette tape. Power is automatically switched off.

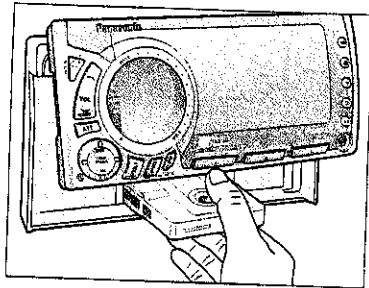

Note:

- If an ejected cassette is left unremoved for longer than 25 seconds, it is automatically retracted inside.
- Be cautious as the front panel is lifted up when ejecting the tape.

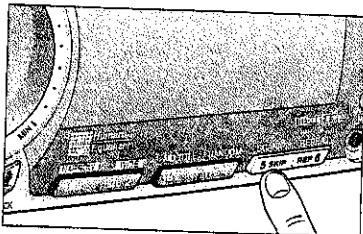

Blank Skip

- When button 5 (SKIP) is pressed, the tape is played for the next selection, skipping the unrecorded part between the current selection and the next, or at the end of the tape.

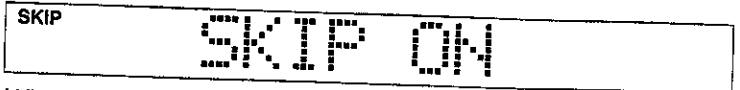

- When button (SKIP) is pressed again, the skip function is released.

Note:

- If both REP (repeat) and BLANK SKIP are ON, REP has priority.
- The blank skip function does not work if an unrecorded part is shorter than 15 seconds.

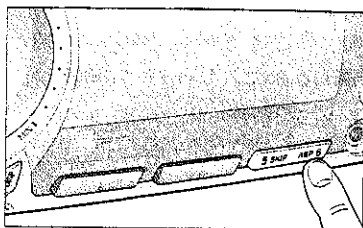

Repeat Playback

- When button 6 (REP) is pressed, the tape is automatically rewound at the end of the present selection to play it back again.



- When button 6 (REP) is pressed again, this function is released.

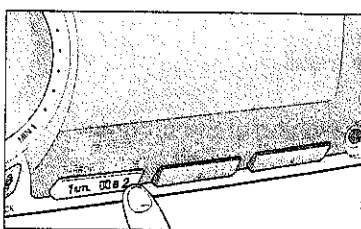

Switching Dolby B NR Mode

- Press button 2 (DOB) to select Dolby B NR mode.



- Press button 2 (DOB) again to release the mode.

Note:

The Dolby B NR function does not work in tuner mode.

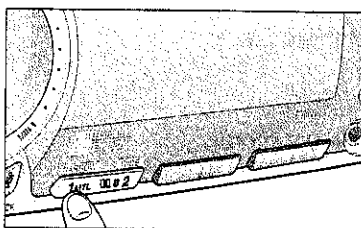

Switching Metal Tape Play Mode

- Press button 1 (MTL) to select metal play mode.

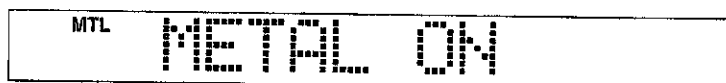

- Press button 1 (MTL) again to release the mode.

Note:

If a normal tape is played in metal tape mode, or if a tape not recorded in Dolby B NR mode is played in Dolby B NR mode, tone quality will be adversely affected by an imbalance in the high-frequency range.

CASSETTE DECK OPERATION (Continued)

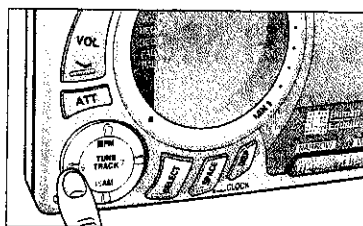
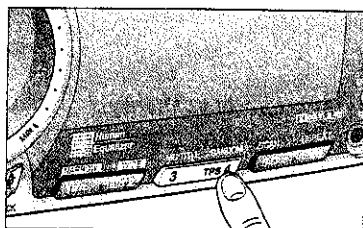

or

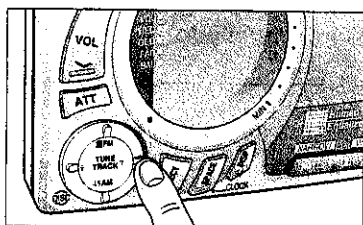

Tape Program Search (TPS)

Press button 4 (TPS) to select TPS mode. Press **◀◀** or **▶▶** as many times as the number of programs you wish to skip. Then the tape is ready for playing at the beginning of your selection.



TPS is kept displayed during TPS operation.

Example 1: To rewind the tape to the beginning of your current selection

- Press button 4 (TPS) and press **◀◀** once.

Example 2: To rewind the tape to the beginning of the program immediately preceding your current selection

- Press button 4 (TPS) and press **◀◀** twice.

Example 3: To wind the tape forward to the beginning of the next program of your current selection

- Press button 4 (TPS) and press **▶▶** once.



Example 4: To wind the tape forward to the beginning of the third program from your current selection

- Press button 4 (TPS) and press **▶▶** three times.

- Press button 4 (TPS) again to release the mode.

Note:

The TPS function may not properly work in the following cases. However, this does not mean anything faulty.

- A cassette tape has an unrecorded part less than 4 seconds long between programs
- Programs may have a part too low in sound level or a silent part (particularly if they are of classical music).

CD PLAYER DISPLAY

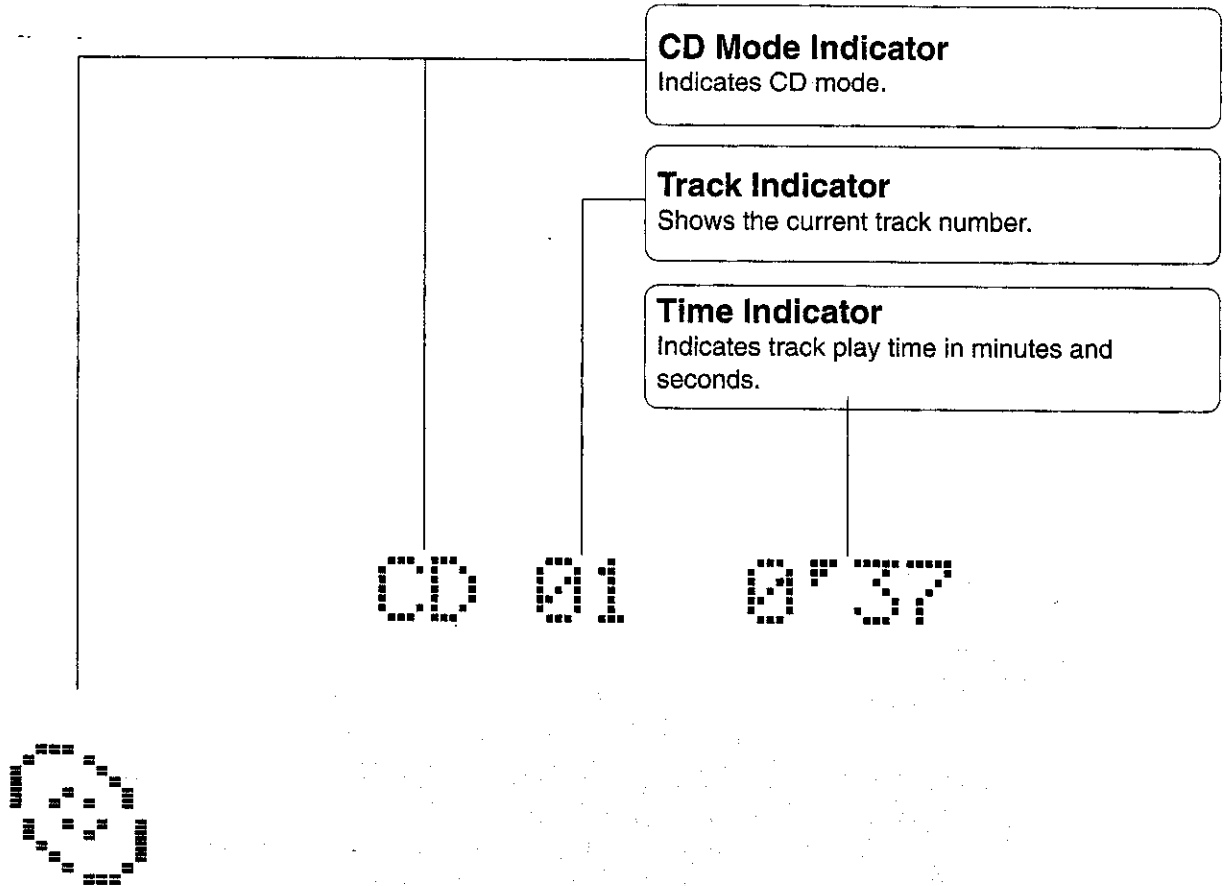

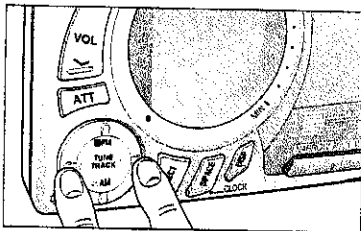
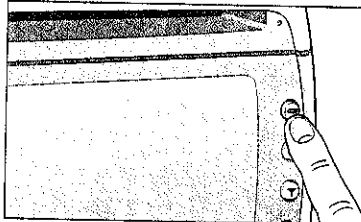
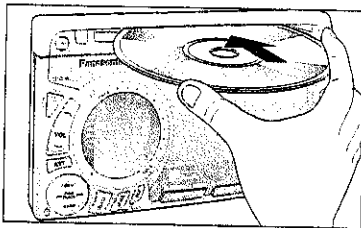
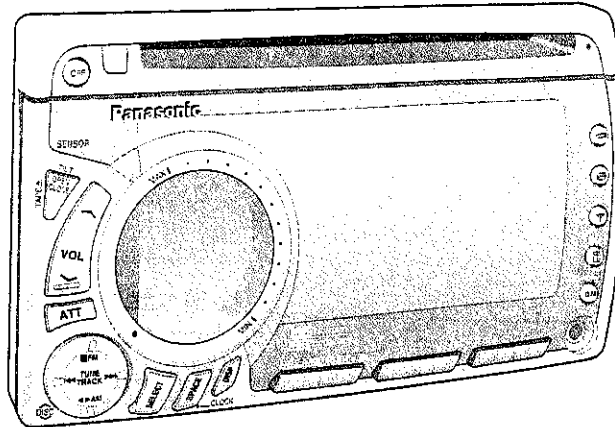

CD PLAYER OPERATION



Inserting and Playing a CD

When a CD is inserted, power is automatically switched on to start playing the CD.

- When a CD is inserted, the CD LOAD indicator () lights.
- To select CD mode from other mode when a CD is already inside, press  (CD).



Selecting a Track

Track selection and search

Press  to turn the CD forward to the beginning of the next track.

Press  to turn the CD backward to the beginning of the current track.

Note:

- Be sure to carefully insert a CD (compact disc) with the label side up. If the label side is down, the CD will be automatically ejected.
- Never use a protect film, stabilizer and the like that are commercially available as CD accessories because they may cause faults or failures.
- No CD can be inserted when the front panel is open. If it is open, press OPEN CLOSE to close the front panel, then insert a CD.

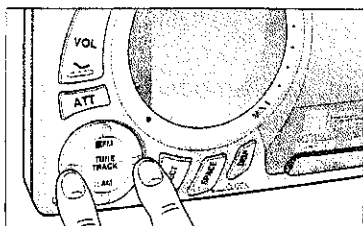

Searching a Track

Search a track by fast forward or backward.

The CD runs fast forward if **▶▶** is pressed for more than 0.5 second. When **▶▶** is released, the CD starts playing again at that point.

The CD runs fast backward if **◀◀** is pressed for more than 0.5 second. When **◀◀** is released, the CD starts playing again at that point.

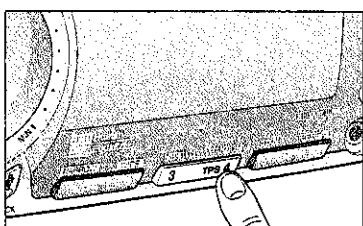

Random Play

- When button 4 (RANDOM) is pressed, programs are automatically selected at random for continual play.



- When button 4 (RANDOM) is pressed again, random play mode is released.

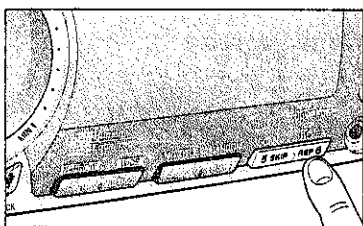

Repeat Play

- Press button 6 (REPEAT) to repeat the current selection. The CD automatically returns to the beginning of the current selection when it has been played.



- Press button 6 (REPEAT) again to release repeat mode.

CD PLAYER OPERATION (Continued)

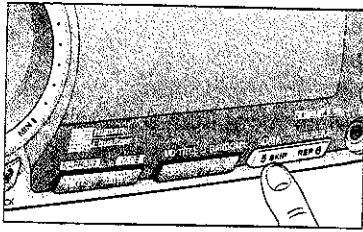

Scanning a CD

- When button 5 (SCAN) is pressed, scan mode is selected beginning with the next to the current selection, and each of the following tracks will be played for 10 seconds in order.



- If a desired program is found, press button 5 (SCAN) to release the mode.
- Scan mode is also released when the CD has come to the beginning of the original program, which will then be played again.

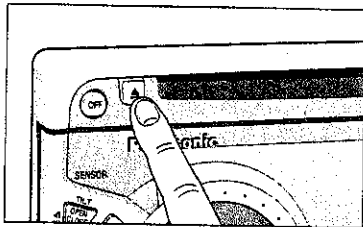

Ejecting a CD

When  is pressed, the CD stops playing and is automatically ejected from the CD slot.

- Power is automatically switched off after the CD is ejected.

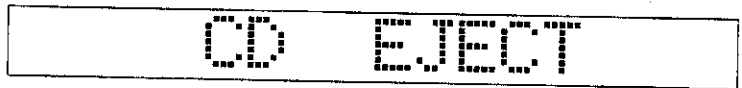

Note:

- If the CD is left unremoved for longer than 25 seconds after ejection, it is automatically retracted inside.
- The panel is closed once to make it easy to remove an ejected CD.

CD/MD CHANGER CONTROL DISPLAY

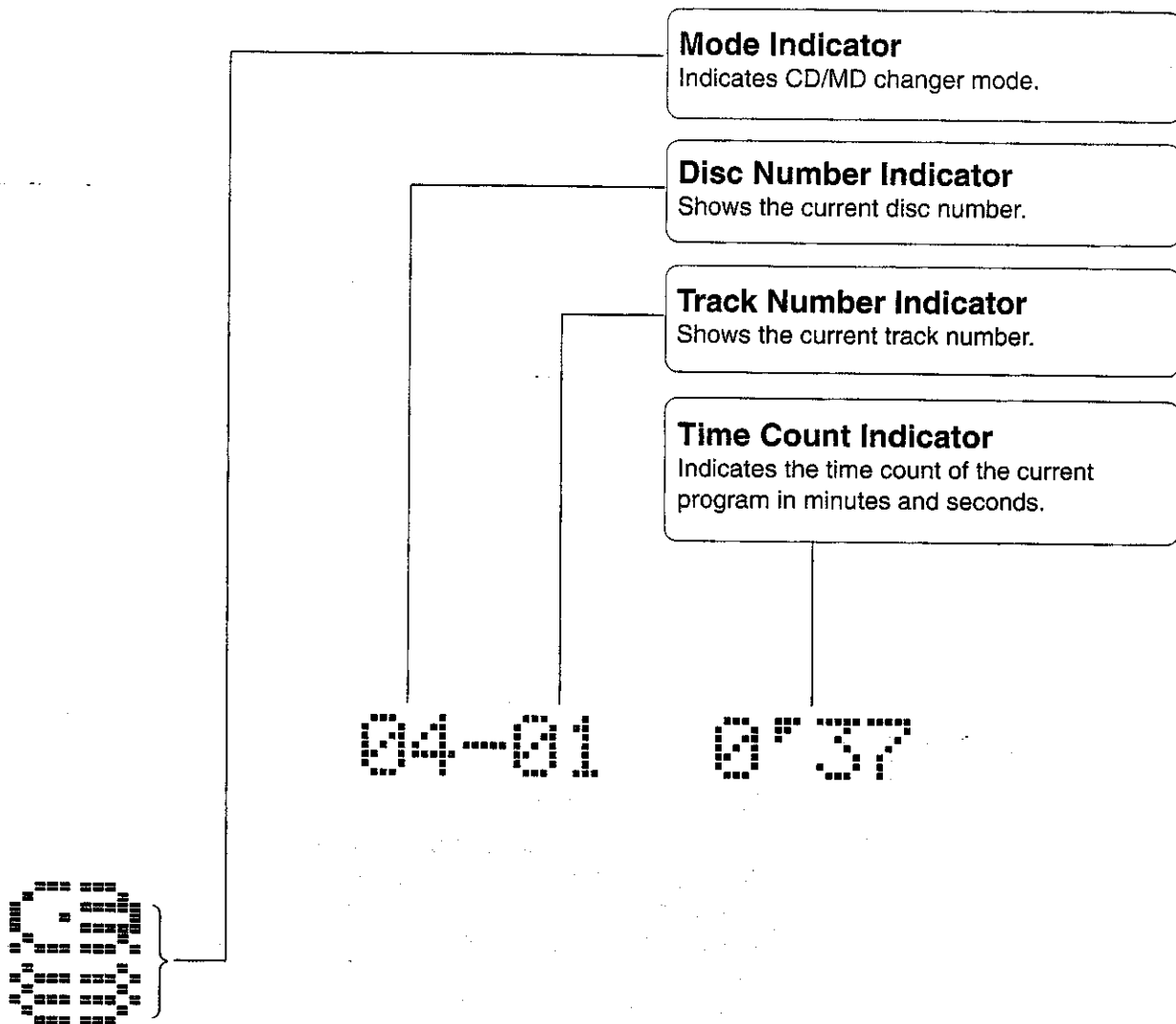

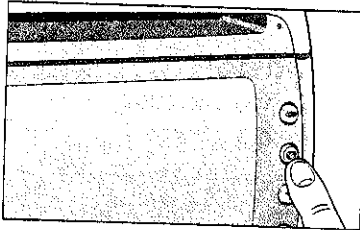
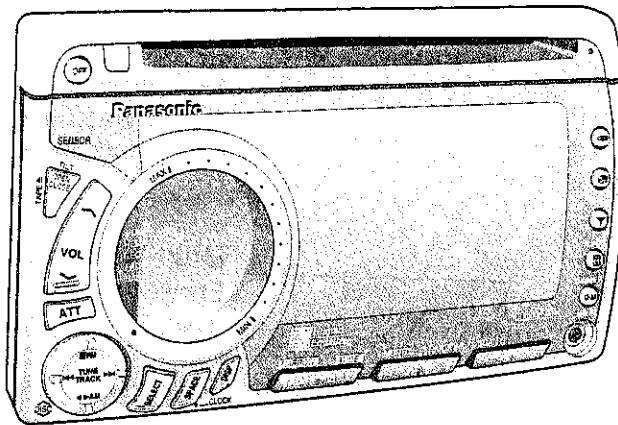

CD/MD CHANGER CONTROL OPERATION

(Continued)





Starting CD/MD Changer

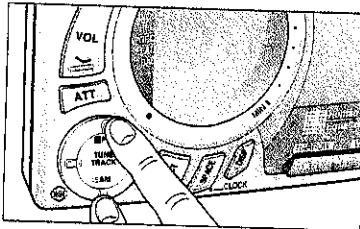

When  (CH.C) is pressed, power is switched on to select CD/MD changer mode. The changer indicator () lights when a CD/MD changer is connected.



Selecting a Disc



Press  to select the preceding disc.
Press  to select the next disc.

Note:

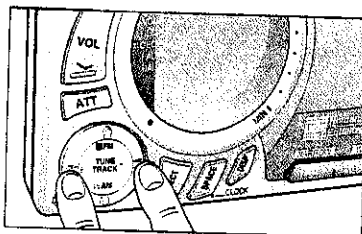
The  and  buttons (DISC UP/DOWN) have priority to track random play, disc random play, track scan play, disc scan play, track repeat play, and disc repeat play mode. If either of these buttons is pressed during any of these modes, the button releases the mode and changes the disc.





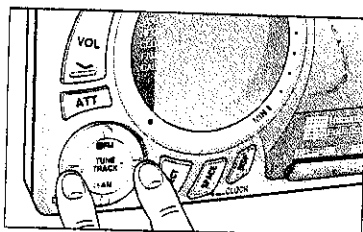

Selecting a Track

Select a track to move the CD back to its beginning.
When  is pressed, the CD runs to the beginning of the next track.
When  is pressed, the CD runs back to the beginning of the current track. When it is pressed twice, the CD runs back to the beginning of the preceding current.



Searching a Track

Search a track by fast forward or backward.
The disc runs fast forward if  is pressed for more than 0.5 second. When  is released, the disc starts playing again at that point.
The disc runs fast backward if  is pressed for more than 0.5 second. When  is released, the disc starts playing again at that point.

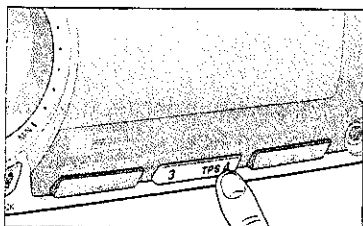

Random Play

① Track random play

- When button 4 (RANDOM) is pressed, the programs on all the discs set in the magazine are automatically selected at random for continual play.



- When button 4 (RANDOM) is pressed again, random play mode is released

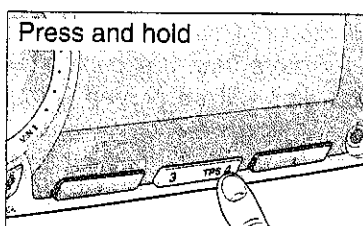

② Disc random play

- When button 4 (RANDOM) is pressed for more than 2 seconds, the programs on the current discs are automatically selected at random for continual play.

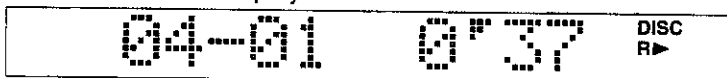

- When button 4 (RANDOM) is pressed for more than 2 seconds again, random play mode is released.

CD/MD CHANGER CONTROL OPERATION

(Continued)

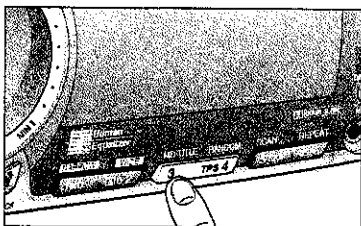
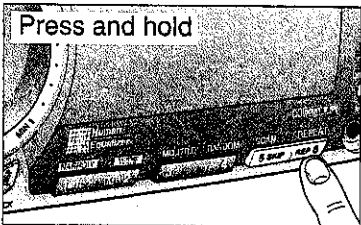
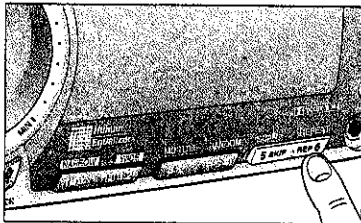
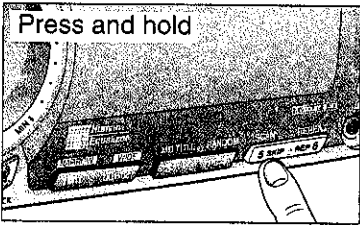
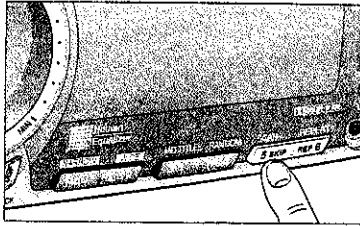

Scanning a Disc

① Track Scan Play

- When button 5 (SCAN) is pressed, the next and subsequent tracks will be played for 10 seconds from the beginning of each in order.



- When button 5 (SCAN) is pressed again, the scan mode is released.
- Scan mode is also released when the disc has come to the program preceding the original program.

② Disc scan play

- When button 5 (SCAN) is pressed for more than 2 seconds, the beginning of the first track on each disc will be played for 10 seconds in order.

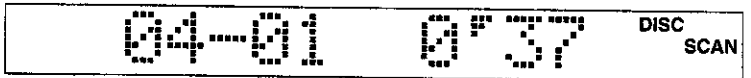

- When button 5 (SCAN) is pressed again for more than 2 seconds, scan mode is released.
- Scan mode is also released when the disc has come to the program preceding the original program.

Repeat Play

① Track repeat play

- Press button 6 (REPEAT) to repeat the current track.



- Press button 6 (REPEAT) again to release repeat mode.

② Disc repeat play

- Press button 6 (REPEAT) for more than 2 seconds to repeat the current disc.



- Press button 6 (REPEAT) again for more than 2 seconds to release repeat mode.

Recalling MD Titles

Call the title information of the MD in the MD changer back on the display. (12 characters maximum)

When button 3 (MD TITLE) is pressed, MD title information appears by turn as follows:

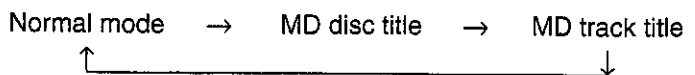

AUX IN DISPLAY

<<AUX IN>>

AUX IN OPERATION

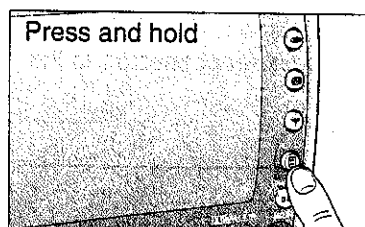
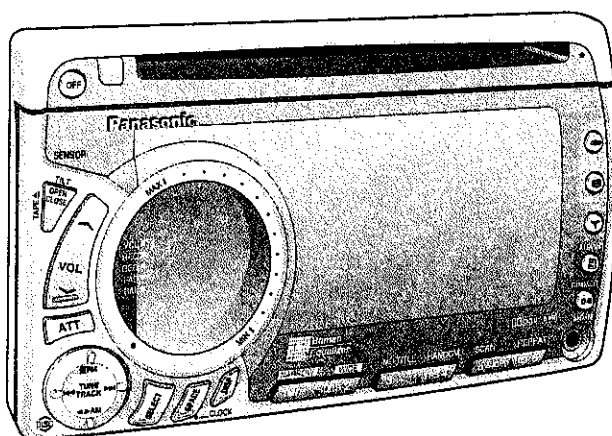

Operation of Audio Set Connected to AUX-IN Rear Jack

When  (AUX IN) is pressed for more than 2 seconds, AUX IN appears on the display, indicating that the audio set connected to the AUX input connector is ready for operation.

Note:

Whatever audio set is connected to AUX IN, its operation should be performed using its controls.

MD IN DISPLAY



MD IN OPERATION

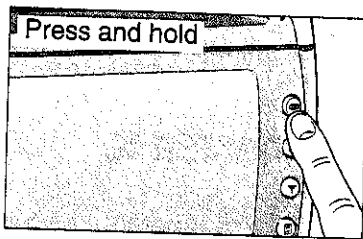
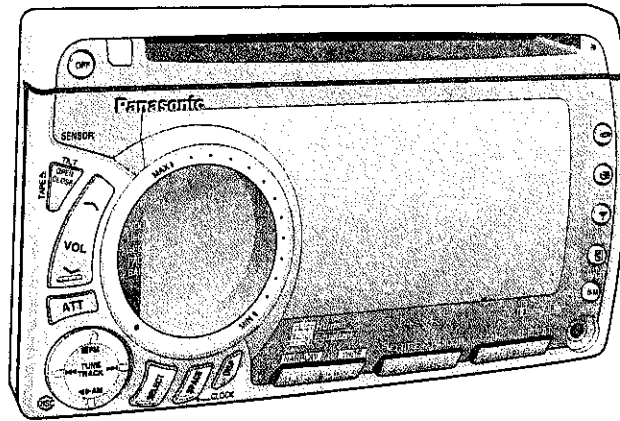

Operation of Audio Set Connected to MD-IN on Front panel

When  (MD IN) is pressed for more than 2 seconds, MD IN appears on the display, indicating that the audio set connected to the MD IN connector is ready for operation

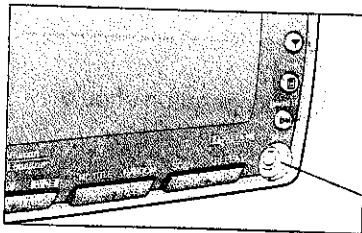

MD IN jack

Note:

Whatever audio set is connected to MD IN, its operation should be performed using its controls.

USEFUL FUNCTIONS

Set Mode Switching, Beep Switching, Navigation Voice Mute Functions

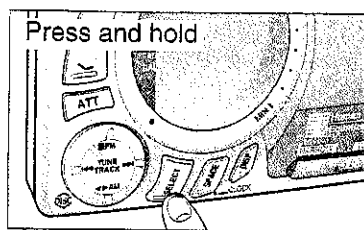

Set Mode Switching

Each time SELECT is pressed for more than 2 seconds, the modes are changed as shown below.

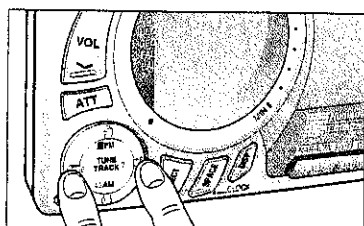
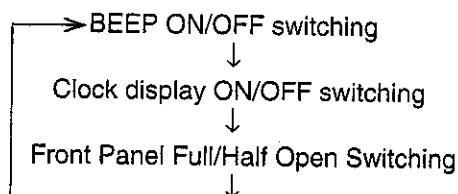

- **Beep ON/OFF switching**
 Press ►► to select ON.
 Press ◄◄ to select OFF.
 When beep ON is selected, a beep is heard from the front speaker each time a control button is pressed.
- **Clock display ON/OFF switching**
 Press ►► to select ON.
 Press ◄◄ to select OFF.
 When ON is selected, clock display has priority while power is on. The time is also displayed while power is off. (In this case, the spectrum analyzer display shows standby.)
- **Front panel full/half open switching**
 Press ►► to select full open.
 Press ◄◄ to select half open.
 The highest panel position changes accordingly. (See page 16.)

Navigation Voice Mute Function

If your set is upgraded by combining it with a Panasonic navigation system (CN-V900, for example), this function automatically lowers the volume of the set in synchronization with the voice guide of the navigation system. Connect the power NAVI mute cord to the NAVI mute cord of the Panasonic navigation system.



CLOCK DISPLAY

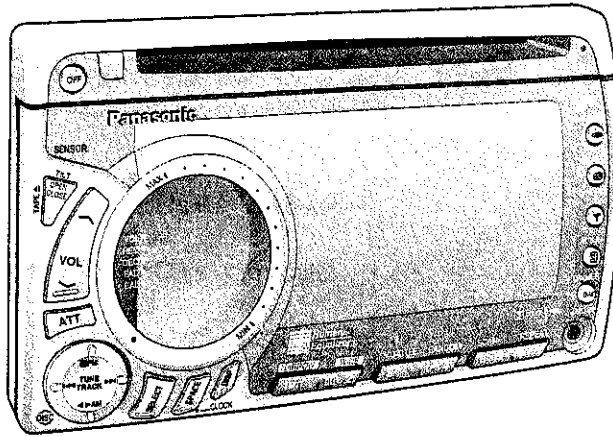

12-hour system
Time is displayed.

CLOCK OPERATION

Your Panasonic set has a 12-hour system clock function.

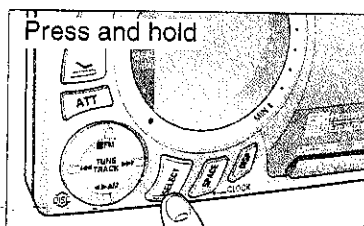

Watching the Clock

<During Operation>

Press SELECT twice for more than 2 seconds each to select clock display ON/OFF, then press ►► to turn clock display on.



If the clock needs adjustment, the word Adjust appears.

<When Power Is OFF>

- ① When OFF is pressed, power is switched off and clock display appears.
- ② All will be turned off when OFF is pressed again.

Note:

If OFF is pressed in normal mode after turning all off, no clock display appears

Note:

- The clock cannot be adjusted in power OFF mode.
- If the clock is unadjusted, the time will not be displayed while power is off.

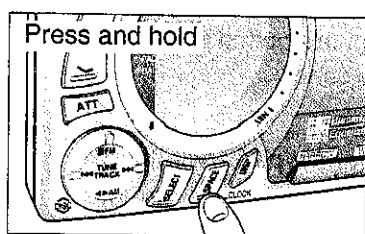
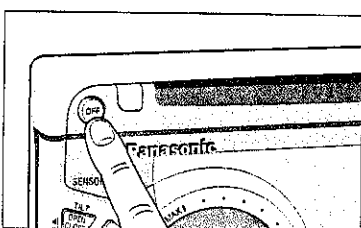

Adjusting the Clock

- ① Press CLOCK (SPACE) for more than 2 seconds to select clock adjust mode.
- ② Press ◀◀ to select hour adjust mode.
Press ■ or ▶▶ to adjust the hours.
Press ►► to adjust minute adjust mode.
Press ■ or ◀▶ to adjust the minutes.
- ③ When you have set the time, press CLOCK (SPACE).

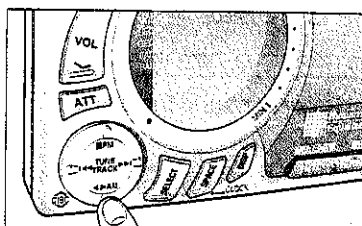

REMOTE CONTROL OPERATION

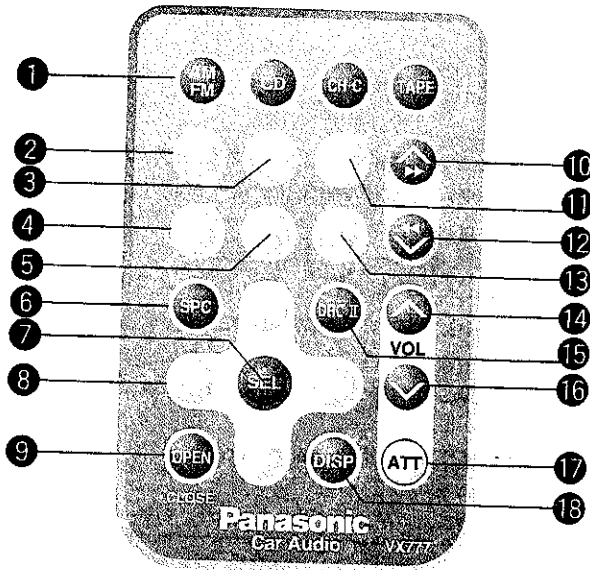

- ① AM/FM button
- ② Preset button 1
- ③ Preset button 2
- ④ Preset button 4
- ⑤ Preset button 5
- ⑥ SPC (SPACE) button
- ⑦ SEL button
- ⑧ ^, v, <, > buttons
- ⑨ Panel OPEN CLOSE button
- ⑩ Frequency up button
- ⑪ Preset button 3
- ⑫ Frequency down button
- ⑬ Preset button 6
- ⑭ Volume up button
- ⑮ DRC II button
- ⑯ Volume down button
- ⑰ ATT button
- ⑱ DISP button

See page 51 for how to place the battery in the remote controller

[Operating Procedures]

Aim the remote controller at the sensor of your Panasonic set.

GENERAL

Volume Adjustment

- ⑭⑯ Volume control buttons**
 Press ^ to increase the volume.
 Press v to decrease the volume.

Sound Field Effect Switching

- ⑥ SPC button**
 The sound field effects change as follows each time SPACE is pressed
 LIVE HOUSE → CONCERT HALL → JAZZ CLUB
 ↑ ↓
 SPACE OFF ← CINEMA ← VOCAL ← DISCO ← STADIUM

Panel Open/Close

- ⑨ Panel OPEN/CLOSE button**
- Press it to open the panel. (If a tape is inside, it will be ejected.)
 - Press it again to close the panel.
 - The panel is tilted each time button is pressed for 0.5 seconds or longer.

Instantaneous Volume Drop (Attenuator)

- ⑰ ATT button**
- The volume falls to about 1/10 of the existing level the moment this button is pressed.
 - Press it again to cancel.

Spectrum Analyzer Display Switching

- ⑱ DISP button**
 16 spectrum analyzer patterns are displayed by turn each time DISP is pressed.

DRC II (Dynamic Road Noise Control II) Switching

- ⑮ DRC button**
 DRC types change as follows each time DRC is pressed.
 DRC II TYPE 1 → DRC II TYPE 2 → DRC II TYPE 3
 ↑ ↓
 DRC II OFF ← DRC II TYPE 4

Tone Quality Adjustment/HEQ Setting

7 SEL, **8** \wedge , \vee , \lt , \gt , **6** SPC, **2** preset 1, **3** preset 2 button

1. HEQ Switching

Equalizer modes change as follows each time SEL is pressed.

Normal Mode (VOL) \rightarrow HEQ \rightarrow GEQ \rightarrow BAL/FAD

\uparrow Preout \leftarrow DRC II \leftarrow SBC/SBC-SW \leftarrow Position \downarrow

2. Selecting Desired Tone Quality

Select a desired tone quality using \wedge , \vee , \lt , \gt .

With the center fixed flat, any of the 49 equalizer patterns, arranged in vertical and horizontal directions, can be selected.

3. Selecting Desired Sound Field Effect

Press SPC to select a desired sound field effect.

1. Press 1 to narrow the sound field (steps 1 to 3).
2. Press 2 to widen the sound field (steps 1 to 3).

GEQ Setting

7 SEL, **8** \wedge , \vee , \lt , \gt

- Press SEL to select GEQ mode.
- Press \lt , \gt (frequency up/down) to select a frequency.
- Press \wedge to raise the level.
Press \vee to lower the level.

GEQ Memory

7 SEL, **8** operation buttons, **6** SPACE, **2** preset 1, **3** prese 2, **11** preset 3, **4** preset 4, **5** preset 5, **15** preset 6

1. Select GEQ.
2. Select a desired equalizer characteristic.
3. Press one of the memory buttons for more than 2 seconds.
4. The preset number flashes, indicating that the selected equalizer characteristic has been saved in the memory.

GEQ Memory Recall

7 SEL, **8** operation buttons, **6** SPACE, **2** preset 1, **3** prese 2, **11** preset 3, **4** preset 4, **5** preset 5, **15** preset 6

1. Press SEL to select GEQ.
2. Press one of the memory buttons.

TUNER (RADIO)

Selecting Tuner Mode

1 AM/FM button

If the mode is other than tuner mode, press this button to change it to tuner mode.

Switching Bands

1 AM/FM button

The AM and FM bands change alternately each time this button is pressed.

Tuning (Manual)

10 \wedge TUNE, **12** TUNE \vee

Press \wedge to raise the frequency.

Press \vee to lower the frequency.

Automatic Seek

10 \wedge TUNE, **12** TUNE \vee

When either of these buttons is pressed for more than 0.5 second, the frequency changes till a station is tuned in to, where the frequency stops automatically. Repeat it till a desired station is received.

Preset Tuning

2 preset 1, **3** prese 2, **11** preset 3, **4** preset 4, **5** preset 5, **15** preset 6

When one of the buttons 1 to 6 preset in the memory is pressed, the corresponding preset station is tuned in to.

Preset Memory

1 AM/FM, **10** \wedge TUNE, **12** TUNE \vee , **2** preset 1, **3** prese 2, **11** preset 3, **4** preset 4, **5** preset 5, **15** preset 6

① Band Switching

Press AM/FM to select the AM or FM band as desired.

② Tuning

Press \wedge TUNE or TUNE \vee to tune in to a desired station.

③ Preset Button Memory

After tuning in to a desired station by steps ① and ② above, press one of the preset buttons 1 to 6 for 2 seconds so the frequency indicator flashes. It indicates that the station has been preset in the memory. Repeat it from FM1 to AM2.

Auto Preset Memory

1 AM/FM, **10** \wedge TUNE, **12** TUNE \vee , **2** preset 1, **3** prese 2, **11** preset 3, **4** preset 4, **5** preset 5, **15** preset 6

- When AM/FM (AUTO PRESET) is pressed for more than 2 seconds, frequency search begins with the lowest of the frequencies on the band being received, and up to 6 stations are automatically stored in the preset memory in the order of signal intensity.
- After search, the preset stations are received for 5 seconds each in order.
- When you find a station you wish to listen to, press the corresponding button among preset buttons 1 to

REMOTE CONTROL OPERATION (Continued)

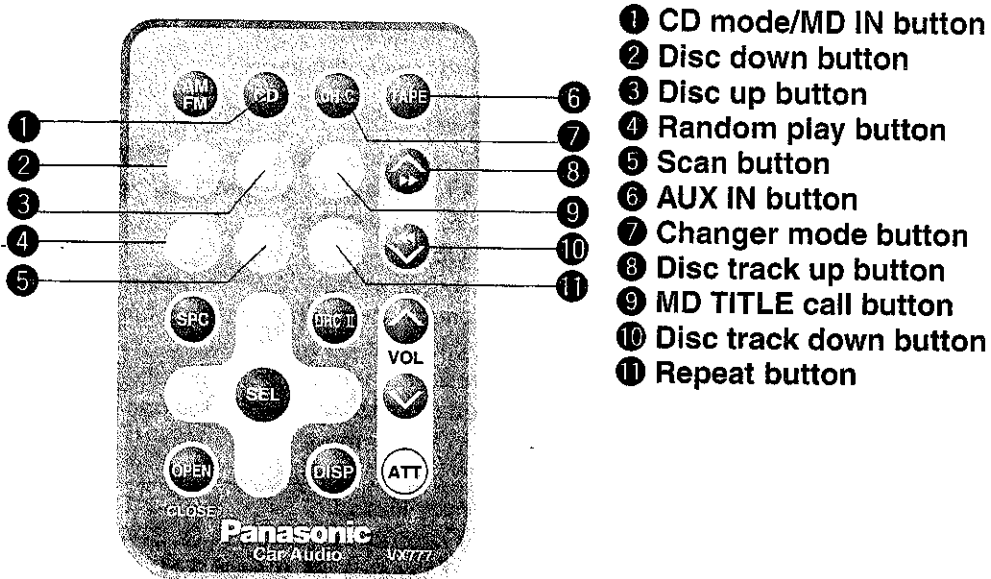

- ① CD mode/MD IN button
- ② Disc down button
- ③ Disc up button
- ④ Random play button
- ⑤ Scan button
- ⑥ AUX IN button
- ⑦ Changer mode button
- ⑧ Disc track up button
- ⑨ MD TITLE call button
- ⑩ Disc track down button
- ⑪ Repeat button

CD PLAYER

Selecting CD Mode

① CD Mode button

If the mode is other than CD mode, press this button to change it to CD mode.

Random Play

④ Random play button

- Press it for random selection and play.
- Press it again to release random mode.

Selecting a Track

⑧ ^ TRACK, ⑩ TRACK ∨

Press ^ once to move to the next track.
Press ∨ once to turn the CD back to the beginning of the current track.

Scanning Tracks

⑤ SCAN button

- When this button is pressed, each track is played for 10 seconds from the beginning in order.
- Press it again to release scan mode.

Fast Forward/Backward

⑧ ^ TRACK, ⑩ TRACK ∨

Keep pressing ^ for fast forward.
Keep pressing ∨ for fast backward.

Repeat Play

⑪ REPEAT button

- When this button is pressed, the current track is repeated.
- Press it again to release repeat mode.

CD/MD CHANGER

Selecting CD/MD Changer Mode

⑦ CH.C (Changer Mode) button

If the mode is other than changer mode, press this button to change it to changer mode.

Selecting a CD

② ∇DISC, ③ DISC∧ button

Press ∧ to move to the next disc.

Press ∇ to move back to the preceding disc.

MD Title

⑨ MD TITLE call button

When this button is pressed, the title recorded on the MD is displayed.

Selecting a Track

⑧ ∧TRACK button, ⑩ TRACK∇ button

Press ∧ once to move to the next track.

Press ∇ to move back to the beginning of the current track.

Fast Forward/Fast Backward

⑧ ∧TRACK button, ⑩ TRACK∇ button

Keep pressing ∧ for fast forward.

Keep pressing ∇ for fast backward.

Random Play

④ Random play button

Track random play

- When this button is pressed, the programs on all the discs in the magazine are selected at random and played.
- Press it again to release track random play mode.

Disc random play

- When the button is pressed for more than 2 seconds, the programs on the current disc are selected at random and played.
- Press it again for more than 2 seconds to release disc random play mode.

Scanning

⑤ SCAN button

Track scan

- When this button is pressed, each track is played for 10 seconds from the beginning in order.
- Press it again to release scan mode.

Disc scan

- When the button is pressed for more than 2 seconds, the first track on each disc is played for 10 seconds each in order.
- Press it again for more than 2 seconds to release scan mode.

Repeat Play

⑪ REPEAT button

Track repeat

- When this button is pressed, the current track is repeated.
- Press it again to release repeat mode.

Disc repeat

- When this button is pressed for more than 2 seconds, the current track is repeated.
- Press it again for more than 2 seconds to release repeat mode.

AUX IN

AUX IN Switching

⑥ AUX IN button

When this button is pressed for more than 2 seconds, the audio set connected to the AUX IN jack is ready for operation.

MD IN

MD IN Switching

① MD IN button

When this button is pressed for more than 2 seconds, the audio set connected to the MD IN jack is ready for operation.

REMOTE CONTROL OPERATION (Continued)

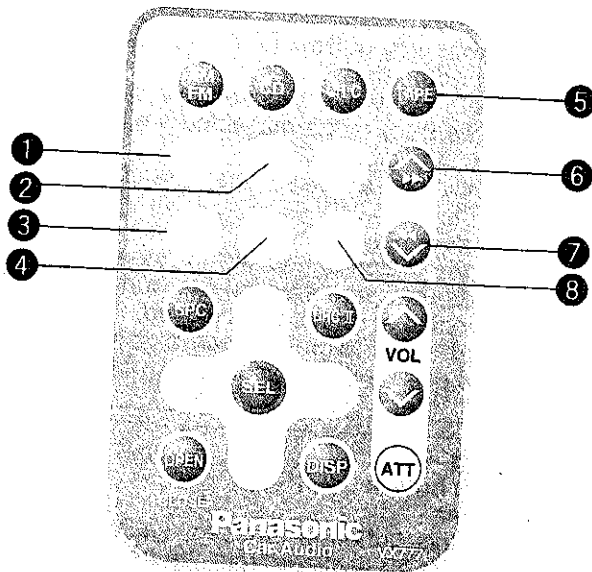

- ① Metal mode button
- ② Dolby B button
- ③ TPS button
- ④ Blank skip button
- ⑤ TAPE mode change/TAPE play button
- ⑥ Fast forward button
- ⑦ Rewind button
- ⑧ Repeat button

CASSETTE DECK

Selecting Tape Mode

⑤ Tape mode button

If the mode is other than tape mode, press this button to change it to tape mode

Changing Tape Sides

⑤ TAPE play button

Each time this button is pressed, the tape sides are alternately changed.

- ► PLAY ► to play the top side
- ◀ PLAY ◀ to play the bottom side

Fast Forward/Rewind

⑥ ►► button, ⑦ ◀◀ button, ⑤ TAPE play button

- Press ►► for fast forward.
 - Press ◀◀ for rewind.
- Press TAPE to stop fast forward/rewind.

Dolby B NR

② Dolby B button

- Press this button for Dolby B NR.
- Press it again to release it.

Metal Mode

① Metal mode button

- Press this button to select metal mode.
- Press it again to release it.

Repeat Play

⑧ REPEAT button

- Press this button to repeat the current selection.
- Press it again to release it.

Blank Skip

④ Blank skip button

- Press this button to skip unrecorded parts of the tape.
- Press it again to release it.

③ TPS, ⑥ ►►, ⑦ ◀◀ buttons

Press TPS to select TPS mode.

- **To rewind the tape to the beginning of the current selection**
Press ◀◀ once.
- **To rewind the tape to the program preceding the current selection**
Press ◀◀ twice. (The tape is rewound to the program preceding it each time ◀◀ is pressed.)
- **To skip to the next program**
Press ►► once. (Each time ►► is pressed, the tape is wound forward to the program indicated by the program number indicator.)

Installation Guide

■ Precautions

If possible, this equipment should be professionally installed. In case of difficulty, please consult with your nearest professional installer.

1. This unit only operates in a 12-volt DC negative ground system.
2. Before performing installation and wiring, remove the negative (-) terminal of the battery. (See Note below.)

Note:

Do not disconnect the negative battery terminal in vehicles equipped with trip or navigational computers. All electronic memory settings previously registered will be lost. Take extra care to avoid causing short-circuits when installing the unit.

3. Follow the wiring connection diagram carefully to avoid causing damage to the unit.
4. Insulate all exposed wires to prevent short-circuits.
5. Secure all loose wires after installing the unit.
6. Please carefully read the operating and installation instructions of any equipment connected to this unit.

■ Transportation bracket removal

Be sure to remove the bracket for transportations before use (installation).

Use screws (M5 x 8 mm) with washers for installation.

Be careful not to lose any of these parts.

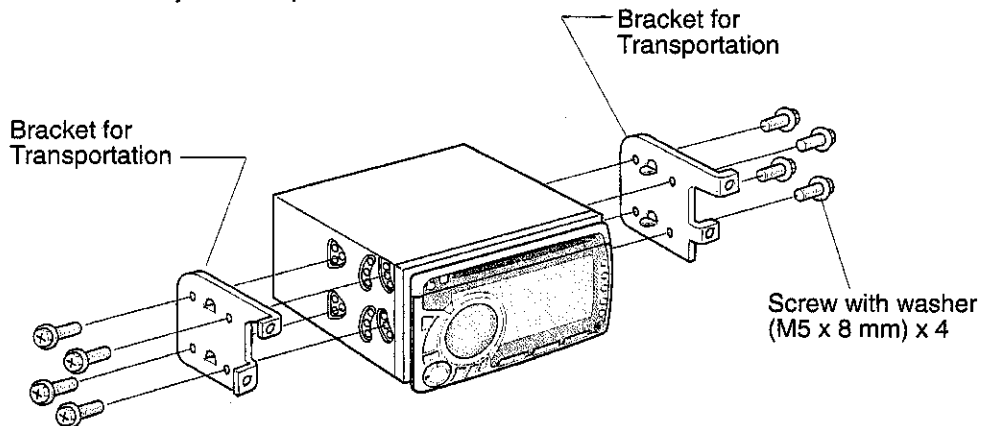

Note:

- The unit is not TAP finished on the right side although there is a screw holes in it. Please only use screws provided to mount the unit.
- To tighten the screws, press its head down straight forward.

■ Installation Hardware

Item	Qty
Screw with washer (M5 x 8mm)	4
Flat-head small screw (M5 x 8mm)	8
Power Connector	1
Remote Control	1
Lithium Battery (CR2025)	1

Electrical Connection

Before Wiring Connection

Note

For installation in cars with trip or navigational computers, all electronic memory settings previously registered in the computer will be lost when the battery terminal is disconnected. Do not disconnect the battery in vehicles equipped with these units. Therefore, extra care should be taken to prevent short-circuits.

- This unit can be connected to an optional CD changer (CX-DP601EN). For details consult your nearest Panasonic dealers.
- For connection to a CD changer, refer to the operating instructions of the CD Changer (CX-DP601EN).

Caution

- To prevent damage to the unit, be sure to follow the connection diagram below.
- Remove the covering of the leads about 5 mm long from their end before connecting.
- Do not insert the power connector into the unit until the wiring is completed.
- Be sure to insulate any exposed wires from a possible short-circuit from the car chassis. Bundle all cables and keep cable terminals free from touching any metal parts.

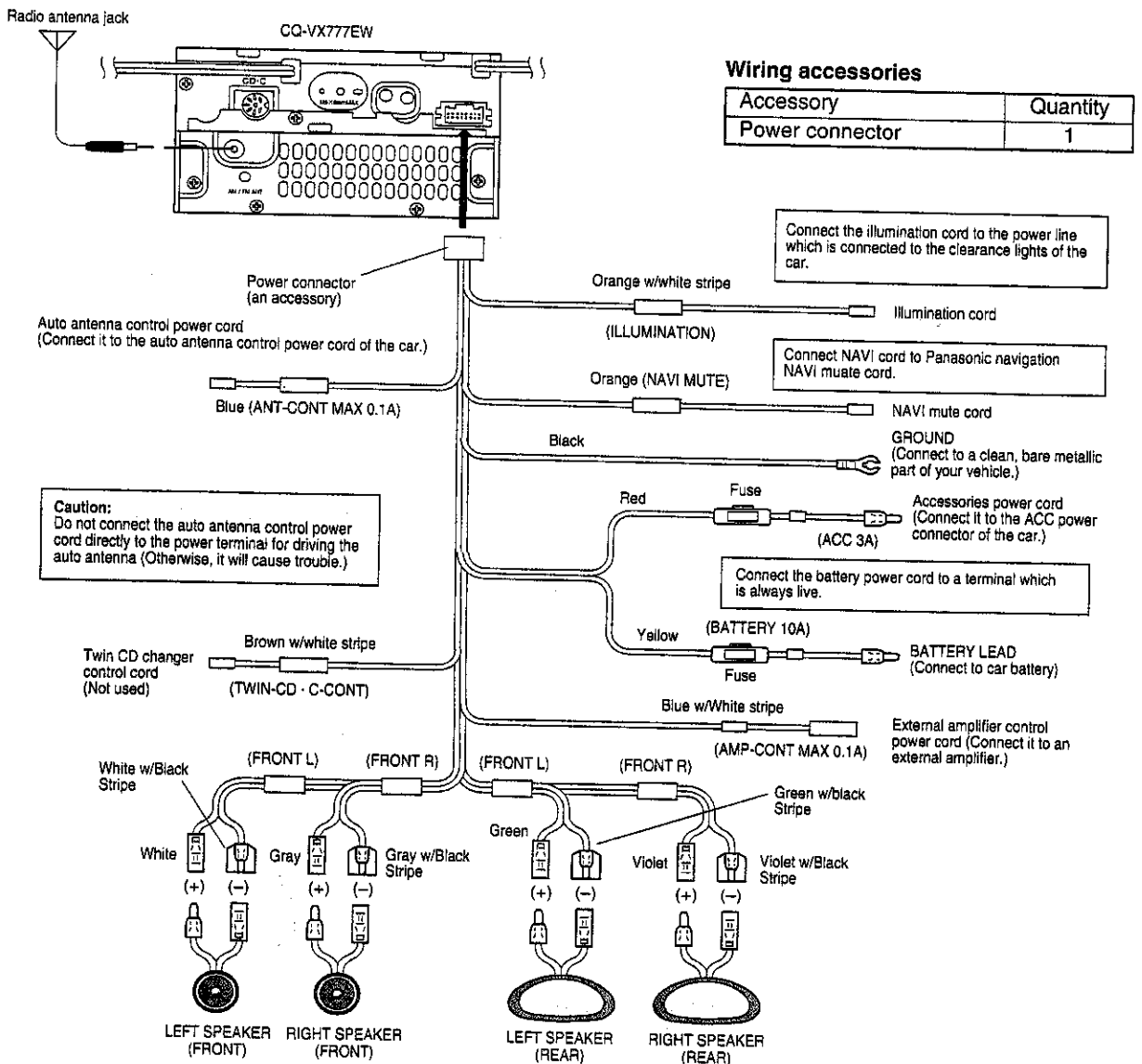

Example of System Grade-up (CD/MD Changer and Six Speakers)

- This set can be used connected to an optional CD/MD changer, for example, Model CX-DP601EN.

With six speakers

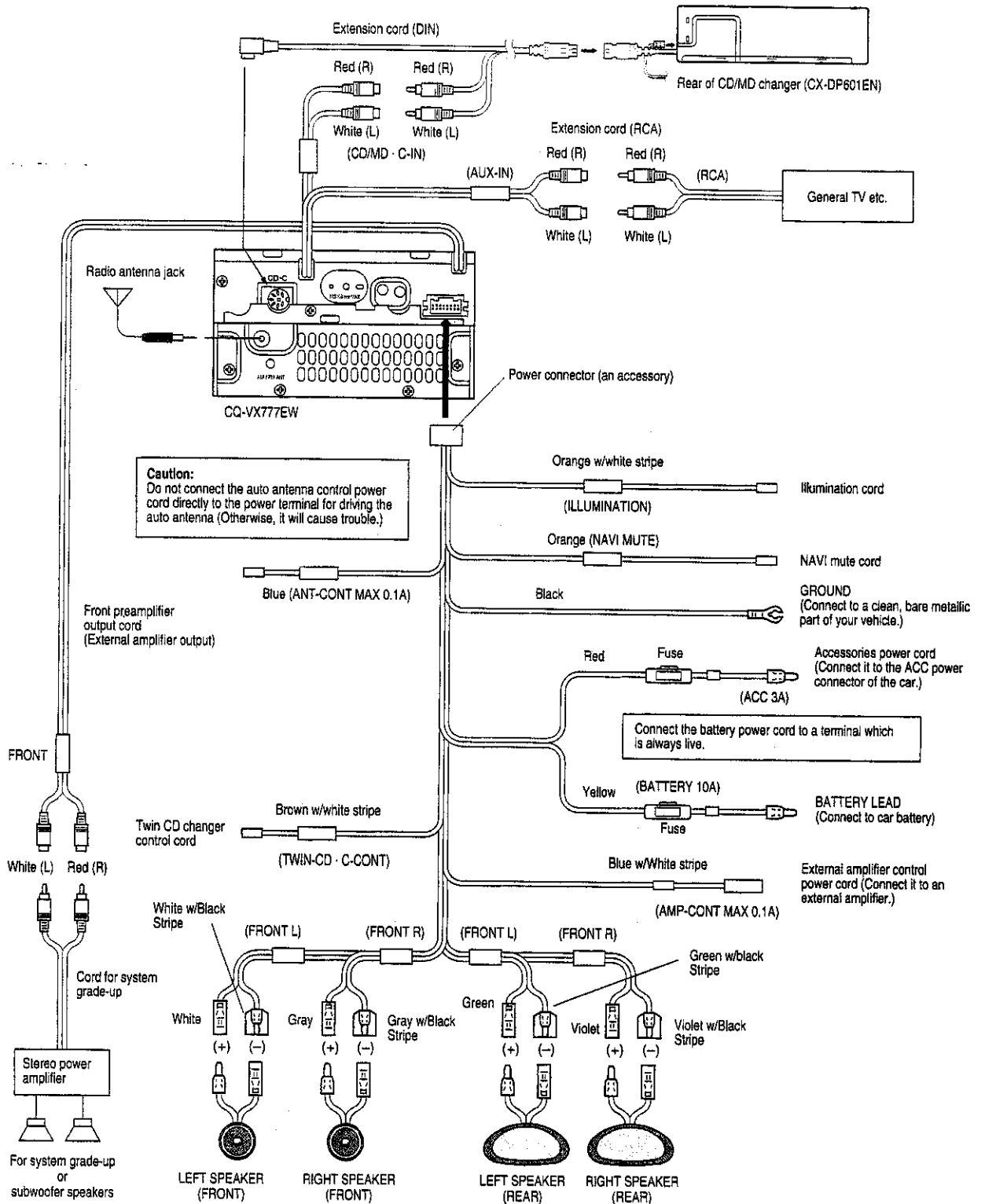

Electrical Connection (Continued)

<Rear Connectors>

- These connectors are used for system grade-up by connecting optional audiovisual appliances for car.
- Refer to the example of system grade-up shown on page 47 for connecting instructions

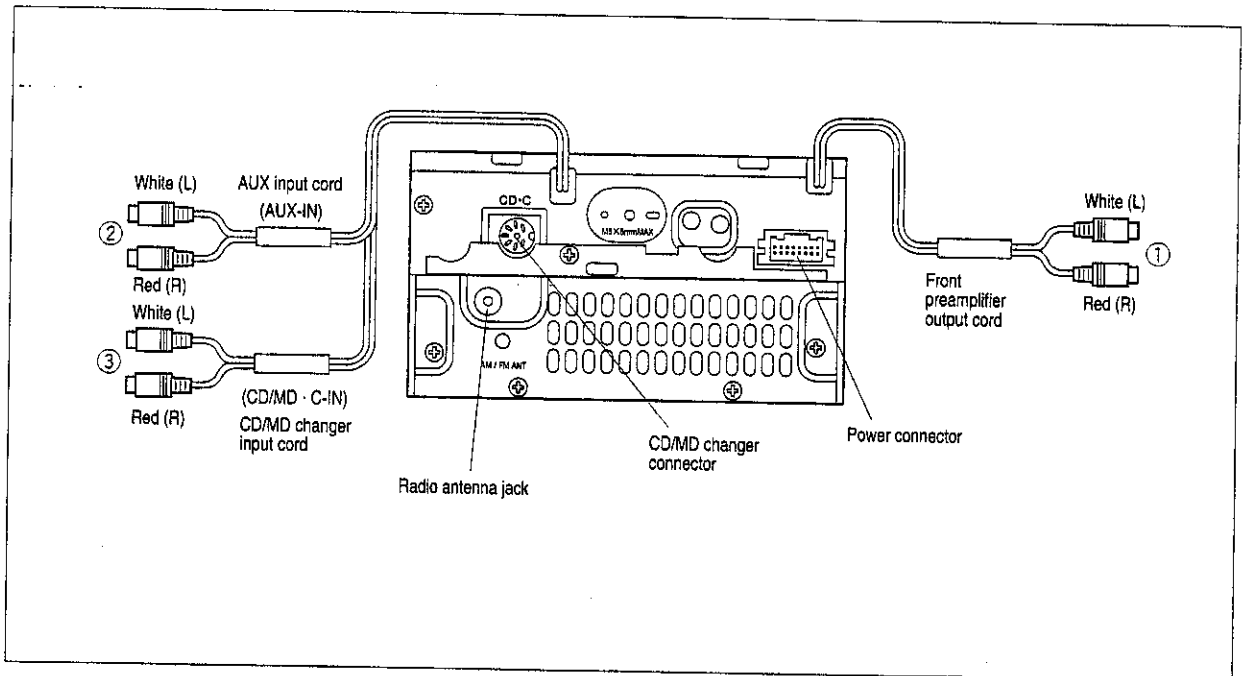

① **Front preamplifier output**
Used for upgrading the system.

② **AUX-IN**
Used to connect this set as a power amplifier for other audio appliances.

③ **CD/MD · C-IN**
Input terminal for audio from CD/MD changer

Troubleshooting

Maintenance

Your product is designed and manufactured to ensure a minimum of maintenance. To clean the exterior of this unit, use a soft cloth to wipe the surface. Do not use benzine, thinner, or any other type of solvent.

Product Servicing

- This unit should only be serviced by qualified technicians. Service information is not provided for customers.
- Should your unit ever require service, refer to the enclosed Panasonic Factory Service center or consult your nearest authorized Panasonic Service Center for detailed instructions.

Replacing the Fuse

Be sure to use a fuse of the specified rating (3A, 10A) when replacing a blown fuse. Fuses with higher capacity ratings, use of any substitute, or connection without a fuse may result in a fire hazard or damage to the unit.

If the replacement fuse fails, contact your nearest authorized Panasonic Service Center.

■ Error Indication

Tape

Display	Description
PLEASE EJECT	Tape cannot be ejected in this state. Press OPEN/CLOSE button.

CD

Display	Description
PLEASE EJECT	CD cannot be ejected in this state. Close the front panel, then press ▲

CD Changer

Display	Description
E1	CD is dirty or the wrong side up. The changer automatically selects the next disc.
E2	CD has a flaw or flaws.
E3	The set is not operating due to some cause. Press the reset button on the changer.
NO DISC	No disc is inside the CD/MD changer, or no magazine is in it.

Note:

The numerals before error symbols E1 and E2 are disc numbers.

Special Notes

Notes on Compact Discs

ONLY USE DISCS CARRYING LABEL SHOWN ON THE RIGHT



- Dirt, dust, scratches and bending of disc will cause misoperation. Handle discs with care.
- Do not place stickers or make scratches on disc.
- Do not bend discs.
- Disc should always be kept in the case when not in use to prevent from damaging.
- Do not place discs in the following places:
 1. Direct sunlight;
 2. Dirty, dusty and damp areas;
 3. Near car heaters;
 4. Seats and dashboard.

Disc Cleaning

Use a dry soft cloth to wipe the surface. If the disc is quite dirty use a soft cloth slightly dampened in isopropyl (rubbing) alcohol. Never use solvents such as benzine, thinner, conventional record cleaner, or mopper as they may mar the surface of the disc.

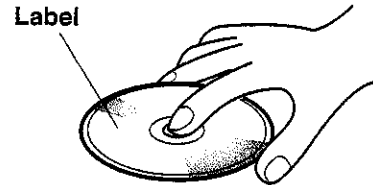

Do not bend.



Wipe the disc from center to outside direction.

Caution for use of a new Disc

A new disc may have rough edges on its inner and outer perimeter. If a disc with rough edges is used, proper setting will not be possible and the CD player will not play the disc. Therefore, remove the rough edges in advance by using a ball-point pen or pencil as shown on right. To remove the rough edges, press the side of the pen or pencil against the inner and outer perimeter of the disc.

Rough edges on outer perimeter

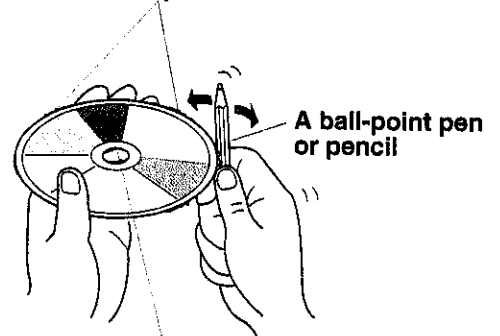

Rough edges on inner perimeter

Battery Replacement

1. **Remove the battery holder.**
Pull the holder by the Position B while pushing Position A in the direction indicated by the arrow.
2. **Replace the battery.**
Set a new battery properly with (+) side up as illustrated.
3. **Insert the battery holder.**
Push in the holder to the original position.

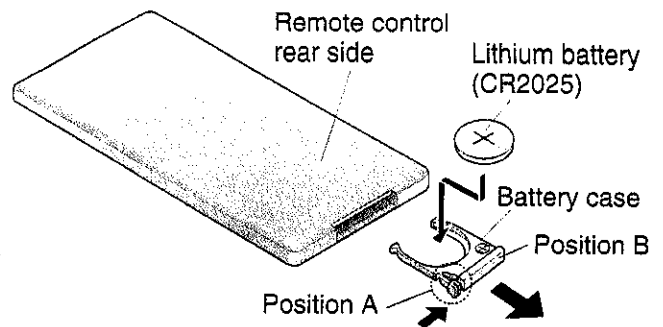

Note on Batteries

Old batteries must immediately be removed and disposed.

Battery Information:

- Designated Battery: Panasonic Lithium Battery (CR2025)
- Battery Life: 6 months with normal use (in normal room temperature)

Caution:

Improper use of batteries may cause overheating, explosion or ignition, resulting in injury or fire. Battery leakage may cause damage to the unit.

- Do not disassemble or short the batteries. Do not throw the batteries into the fire.
- To avoid the risk of accident, keep the batteries out of reach of children.

Notes on Cassette Tapes

Tape Slack:

Use a pencil or similar object to take up the slack as shown. If a loose tape is used, this may result in the tape becoming tangled in the rotating parts of the unit.

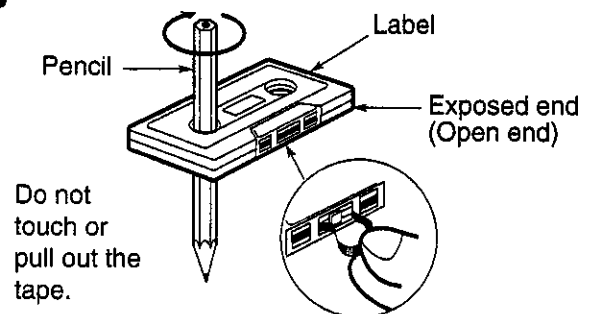

Specifications

GENERAL

Power Supply	: 12 V DC (11 V - 16 V) ; test Voltage, 14.4 V; negative ground
Current Consumption	: 8.5 A (at rated tape operation output)
Rated output	: 13 W x 4 channels (100Hz, 1%, 4Ω)
Maximum output	: 30 W x 4 channels
Suitable speaker impedance	: 4Ω
Audio input impedance	: 10kΩ
Audio input sensitivity	: 600mV
PRE-OUT output voltage	: 600mV
PRE-OUT output impedance	: 600Ω
External dimensions	: 178 (W) x 100 (H) x 160 (D) mm
Weight	: 3.2kg

Tuners

FM Tuners

Frequency range	: 87.5 to 108.0 MHz
Useable sensitivity	: 12 dBf
Total harmonic distortion (mono)	: 0.3% (1kHz)
Weighted S/N ratio (mono)	: 70dB
Frequency response	: 20 to 15,000 Hz ±3 dB
Stereo separation	: 42dB (1kHz)
Image-rejection ratio	: 65 dB

AM Tuners

Frequency Range	: 531 to 1,602 kHz
Useable Sensitivity (S/N 20dB)	: 27 dB/μV
Image-jamming ratio	: 65 dB

Cassette Tape Player

Reproduction system	: 4-track, 2-program stereo
Tape speed	: 1-7/8"/sec (4.76 cm/sec)
Fast forward time	: 100 sec (C-60)
Rewind time	: 100 sec (C-60)
Wow and flutter	: 0.07% (WRMS)
Signal/Noise ratio	: Dolby NR OFF 56 dB (IHF, A) Dolby NR ON 66 dB (IHF, A)
Frequency response	: 30 to 18,000 Hz (normal tape) 30 to 20,000 Hz (metal tape)

CD Player

Number of channel	: 2 channels
Quantization	: 16-bit linear (4.76 cm/sec)
Frequency response	: 5 to 20,000 Hz (±1 dB)
Dynamic range	: 90dB (1kHz)
Wow and flutter	: Below measurable limits

DSP

Number of channel	: 2 channels for Input; 4 channels for output
Reverberation level adjustment	: 7 steps
Equalizer center frequency	: 80, 160, 320, 640, 1.6k, 4k, 10k (Hz)
Equalizer range	: -12 dB to +12 dB (13 step)

Note:

Specifications and design are subject to modification without notice due to improvements in technology.

Dolby noise reduction manufactured under license from Dolby Laboratories Licensing Corporation. "DOLBY" and the double-D symbol  are trademarks of Dolby Laboratories Licensing Corporation.