

■ Read the operating instructions for the unit and all other components of your car audio system carefully before using the system. They contain instructions about how to use the system in a safe and effective manner. Panasonic assumes no responsibility for any problems resulting from failure to observe the instructions given in this manual.

■ This manual uses pictographs to show you how to use the product safely and to alert you to potential dangers resulting from improper connections and operations. The meanings of the pictographs are explained below. It is important that you fully understand the meanings of the pictographs in order to use this manual and the system properly.



Warning

This pictograph intends to alert you to the presence of important operating instructions and installation instructions. Failure to heed the instructions may result in severe injury or death.



Caution

This pictograph intends to alert you to the presence of important operating instructions and installation instructions. Failure to heed the instructions may result in injury or material damage.

Warning

Observe the following warnings when using this unit.

- ❑ **The driver should neither watch the display nor operate the system while driving.**
Watching the display or operating the system will distract the driver from looking ahead of the vehicle and can cause accidents. Always stop the vehicle in a safe location and use the parking brake before watching the display or operating the system.
- ❑ **Use the proper power supply.**
This product is designed for operation with a negative grounded 12 V DC battery system. Never operate this product with other battery systems, especially a 24 V DC battery system.
- ❑ **Keep batteries and insulation film out of reach of infants.**
Batteries and insulation film can be ingested, so keep them out of the reach of infants. If an infant ingests a battery or insulation film, please seek immediate medical attention.
- ❑ **Protect the Deck Mechanism.**
Do not insert any foreign objects into the slot of this unit.
- ❑ **Do not disassemble or modify the unit.**
Do not disassemble, modify the unit or attempt to repair the product yourself. If the product needs to be repaired, consult your dealer or an authorized Panasonic Service center.
- ❑ **Do not use the unit when it is out of order.**
If the unit is out of order (no power, no sound) or in an abnormal state (has foreign matter in it, is exposed to water, is smoking, or smells), turn it off immediately and consult your dealer.
- ❑ **The remote control unit should not lie about in the car.**
If the remote control unit lies about, it could fall on the floor while driving, get wedged under the brake pedal, and lead to a traffic accident.
- ❑ **Refer fuse replacement to qualified service personnel.**
When the fuse burns out, eliminate the cause and have it replaced with the fuse prescribed for this unit by a qualified service engineer. Incorrect replacement of the fuse may lead to smoke, fire, and damage to the product.

Observe the following warnings when installing.

- ❑ **Disconnect the lead from the negative (–) battery terminal before installation.**
Wiring and installation with the negative (–) battery terminal connected may cause electrical shock and injury due to a short circuit.
Some cars equipped with the electrical safety system have specific procedures of battery terminal disconnection.
FAILURE TO FOLLOW THE PROCEDURE MAY LEAD TO THE UNINTENDED ACTIVATION OF THE ELECTRICAL SAFETY SYSTEM RESULTING IN DAMAGE TO THE VEHICLE AND PERSONAL INJURY OR DEATH.
- ❑ **Never use safety-related components for installation, grounding, and other such functions.**
Do not use safety-related vehicle components (fuel tank, brake, suspension, steering wheel, pedals, airbag, etc.) for wiring or fixing the product or its accessories.
- ❑ **Installing the product on the air bag cover or in a location where it interferes with airbag operation is prohibited.**
- ❑ **Check for piping, gasoline tank, electric wiring, and other items before installing the product.**
If you need to open a hole in the vehicle chassis to attach or wire the product, first check where the wire harness, gasoline tank, and electric wiring are located. Then open the hole from outside if possible.
- ❑ **Never install the product in a location where it interferes with your field of vision.**
- ❑ **Never have the power cord branched to supply other equipment with power.**
- ❑ **After installation and wiring, you should check the normal operation of other electrical equipment.**
The continuation of their using in abnormal conditions may cause fire, electrical shock or a traffic accident.
- ❑ **In the case of installation to an airbag-equipping car, confirm warnings and cautions of the vehicle manufacturer before installation.**
- ❑ **Make sure the leads do not interfere with driving or getting in and out of the vehicle.**
- ❑ **Insulate all exposed wires to prevent short circuiting.**



Caution

Observe the following cautions when using this unit.

- ❑ **Keep the sound volume at an appropriate level.**
Keep the volume level low enough to be aware of road and traffic conditions while driving.
- ❑ **Do not insert or allow your hand or fingers to be caught in the unit.**
To prevent injury, do not get your hand or fingers caught in moving parts or in the disc slot. Especially watch out for infants.
- ❑ **This unit is designed for use exclusively in automobiles.**
- ❑ **Do not operate the unit for a prolonged period with the engine turned off.**
Operating the audio system for a long period of time with the engine turned off will drain the battery.
- ❑ **Do not expose the unit to direct sunlight or excessive heat.**
Otherwise these will raise the interior temperature of the unit, and it may lead to smoke, fire, or other damage to the unit.
- ❑ **Do not use the product where it is exposed to water, moisture, or dust.**
Exposure of the unit to water, moisture, or dust may lead to smoke, fire, or other damage to the unit. Make especially sure that the unit does not get wet in car washes or on rainy days.

Observe the following cautions when installing.

- ❑ **Refer wiring and installation to qualified service personnel.**
Installation of this unit requires special skills and experience. For maximum safety, have it installed by your dealer. Panasonic is not liable for any problems resulting from your own installation of the unit.
- ❑ **Follow the instructions to install and wire the product.**
Not following the instructions to properly install and wire the product could cause an accident or fire.
- ❑ **Take care not to damage the leads.**
When wiring, take care not to damage the leads. Prevent them from getting caught in the vehicle chassis, screws, and moving parts such as seat rails. Do not scratch, pull, bend or twist the leads. Do not run them near heat sources or place heavy objects on them. If leads must be run over sharp metal edges, protect the leads by winding them with vinyl tape or similar protection.
- ❑ **Use the designated parts and tools for installation.**
Use the supplied or designated parts and appropriate tools to install the product. The use of parts other than those supplied or designated may result in internal damage to the unit. Faulty installation may lead to an accident, a malfunction or fire.
- ❑ **Do not block the air vent or the cooling plate of the unit.**
Blocking these parts will cause the interior of the unit to overheat and will result in fire or other damage.

❑ **Do not install the product where it is exposed to strong vibrations or is unstable.**

Avoid slanted or strongly curved surfaces for installation. If the installation is not stable, the unit may fall down while driving and this can lead to an accident or injury.

❑ **Installation Angle**

The product should be installed in a horizontal position with the front end up at a convenient angle, but not more than 30°.

The user should bear in mind that in some areas there may be restrictions on how and where this unit must be installed. Consult your dealer for further details.

❑ **Wear gloves for safety. Make sure that wiring is completed before installation.**

❑ **To prevent damage to the unit, do not connect the power connector until the whole wiring is completed.**

❑ **Do not connect more than one speaker to one set of speaker leads. (except for connecting to a tweeter)**

Observe the following cautions when handling the batteries for the remote control unit.

- Use only specified battery (CR2025).
- Match the polarity of the battery with the (+) and (–) marks in the battery case.
- Replace dead battery as soon as possible.
- Remove the battery from the remote control unit when not using it for an extended period of time.
- Insulate the battery (by placing them in a plastic bag or covering them with vinyl tape) before disposal or storage.
- Dispose of the battery according to the local regulations.
- Do not disassemble, recharge, heat or short the battery. Do not throw a battery into a fire or water.

In case of battery leakage

- Thoroughly wipe the battery liquid off the battery case and insert new battery.
- If any part of your body or clothing comes into contact with battery liquid, wash it with plenty of water.
- If battery liquid comes into contact with your eyes, wash them with plenty of water and get immediate medical attention.

Label Indications and Their Locations

CAUTION
LASER RADIATION WHEN OPEN. DO NOT STARE INTO BEAM.

Caution
THIS PRODUCT IS A CLASS 1 LASER PRODUCT. USE OF CONTROLS OR ADJUSTMENTS OR PERFORMANCE OF PROCEDURES OTHER THAN THOSE SPECIFIED HEREIN MAY RESULT IN HAZARDOUS RADIATION EXPOSURE. DO NOT OPEN COVERS AND DO NOT REPAIR BY YOURSELF. REFER SERVICING TO QUALIFIED PERSONNEL.

Do not take apart this unit or attempt to make any changes yourself.
This unit is a very intricate device that uses a laser pickup to retrieve information from the surface of compact discs. The laser is carefully shielded so that its rays remain inside the cabinet.
Therefore, never try to disassemble the player or alter any of its parts since you may be exposed to laser rays and dangerous voltages.

CLASS 1 LASER PRODUCT

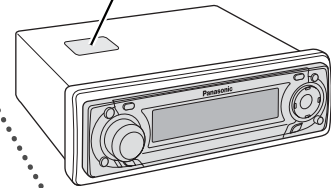

CAUTION - LASER RADIATION WHEN OPEN. AVOID EXPOSURE TO BEAM.

ВНИМАНИЕ - ЛАЗЕРНОЕ ИЗЛУЧЕНИЕ ПРИ ОТКРЫТИИ. ИЗБЕЖАТЬ ВОЗДЕЙСТВИЯ ЛАЗЕРНОГО ИЗЛУЧЕНИЯ.

注意 - 打开时避免被激光辐射光照射到。

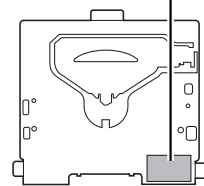

Deck Ass'y (Upper Side)

Before Reading These Instructions

Panasonic welcomes you to our constantly growing family of electronic products owners. We endeavor to give you the advantages of precise electronic and mechanical engineering, manufactured with carefully selected components, and assembled by people who are proud of the reputation their work has built for our company. We know this product will bring you many hours of enjoyment, and after you discover the quality, value and reliability we have built into it, you too will be proud to be a member of our family.

CQ-C9901W

WMA MP3 CD Player/Receiver with 512 Color OEL (Organic electroluminescence) Display

CQ-C9801W

WMA MP3 CD Player/Receiver with Full Dot Matrix Display

This operating instruction manual is for 2 models CQ-C9901W and CQ-C9801W. The difference among these models' are mentioned below. All screens and main body illustrations in this book represent CQ-C9901W unless otherwise specified.

Features	Models	CQ-C9901W	CQ-C9801W
Display unit		512 Color OEL	Full Dot Matrix (Light Blue)

 Operating Instructions (YEFM285648) Q'ty: 1	 Installation Instructions (YEFM293973) Q'ty: 1	 Removable Face Plate Case (YEFA131646) Q'ty: 1	 Remote Control Unit (Includes a battery: CR2025) (EUR7641010) Q'ty: 1
 Lock Cancel Plate Q'ty: 2	 Mounting Bolt Q'ty: 1	 Tapping Screw (5 mmø x 16 mm) Q'ty: 1	 Hexagonal Nut (5 mmø) Q'ty: 1
Installation kit (YEP0FZ5701)			
 Trim Plate (YEFC05606): CQ-C9801W (YEFC05655): CQ-C9901W Q'ty: 1	 Mounting Collar (YEFX0217222) Q'ty: 1	 Power Connector (YEAJ02871) Q'ty: 1	 Rear Support Strap (YFEG04019) Q'ty: 1

Notes:

- The number in parenthesis underneath each accessory part name is the part number for maintenance and service.
- Accessories and their parts numbers are subject to modification without prior notice due to improvements.
- Mounting Collar and Trim Plate are mounted on the main unit at shipment.

Full Digital CD Receiver

The CQ-C9901W/C9801W uses Radio DSP for digital conversion and processing of FM/AM signals, and a digital amp to provide amplification of the digital data. With this technology, Panasonic achieves full digital processing of radio and CD signals from input to speaker output. This means faithful reproduction of the original sound.

Radio DSP

By digitally converting and processing FM/AM broadcast signals, this greatly reduces adjacent interference and multipath distortion.

A radio's IF filter has the job of preventing neighboring broadcast frequencies from interfering with reception of your desired station. Panasonic's Radio DSP uses an advanced algorithm to perform this task with digital control. It maintains the optimum balance between noise suppression and sound quality by automatically adjusting the IF filter bandwidth in response to the changing interference characteristics as you drive.

Fully Motorized Front Panel

A touch is all it takes to slide the front panel down for access to the disc slot. A three-stage tilt function permits viewing angle to be adjusted to 15, 25 or 35 degrees for optimum display visibility.

256x64 pixel 512-color OEL display (CQ-C9901W only)

Multicolored expression can be achieved thanks to OEL display. You can use this unit in your original way in collaboration with the customization function.

Delightful sound space thanks to system buildup

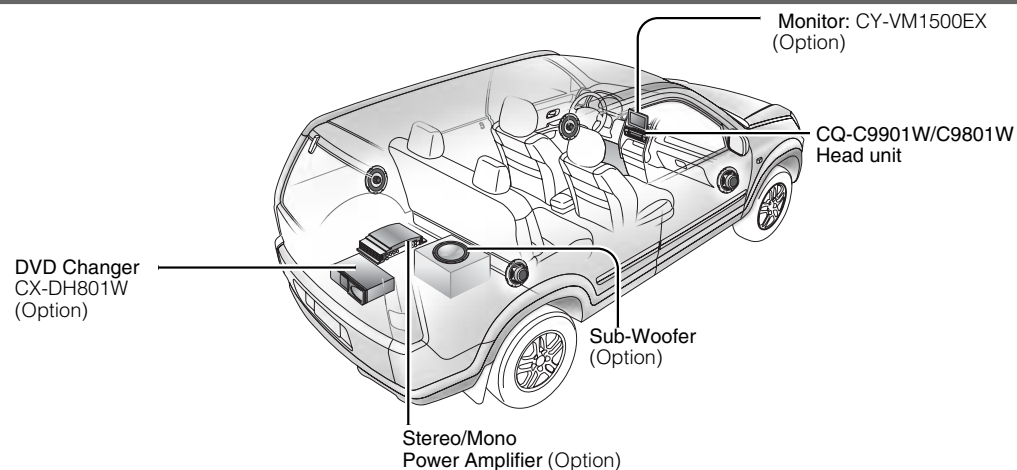

Sound Control

CS Auto (CIRCLE SURROUND AUTOMOTIVE)
CS Auto allows your car interior to change to a splendid audio room in a moment. Every speaker can be fine-tuned. (→ page 16)

*CS Auto, TruBass, FOCUS, SRS and symbol are trademarks of SRS Labs, Inc. CS Auto technology is incorporated under license from SRS Labs, Inc.

Note: If you enable CS Auto, the following functions are automatically disabled:

SQ, POSITION, BASS/TREBLE, BALANCE/FADER, SUB-WOOFER LEVEL, LPF, HPF, SBC-SW

SQ (SOUND QUALITY)

You have six preset modes (FLAT, POP, ROCK, VOCAL, JAZZ, CLUB). You can customize your settings for these (except FLAT) and save them for instant recall.

SQ9 (9-Band Sound Quality)

Center frequency and level are adjustable in each of nine bands. This lets you fine tune sound quality for each genre to suit car-interior acoustics and your personal preferences. (→ page 16)

Full lineup of optional parts

You can also enjoy watching DVDs if the optional DVD changer and display unit are connected.

New radio tuner

Innovated APM (Auto Preset Memory) method for FM bands. In addition to the conventional method (EACH BAND), we have successfully launched the enhanced ALL BAND method that presets 18 stations at the same time. (→ page 21)

English

中文	46
한국어	90

Common

● Safety Information	2
● Before Reading These Instructions	4
● Features	6
● Controls Layout	8
● Preparation	10
● General	12
● Sound Control	16

Each Source

● Radio	19
● CD Player	22
● MP3/WMA Player	24
● Disc Changer (when CDs or MP3 discs are loaded)	28
● Disc Changer (when DVDs or VCDs are loaded)	30

As Needed

● Audio Setting	32
● Function Setting	34
● Display Setting	35
● Customize the Display	36
● Troubleshooting	38
● Error Display Messages	42
● Notes on Discs	43
● Maintenance	44
● Contents by Functions	44
● Specifications	45

Controls Layout

Note: This instruction manual explains operations for use with the buttons on the main unit. (Different operations excluded)

Main Unit

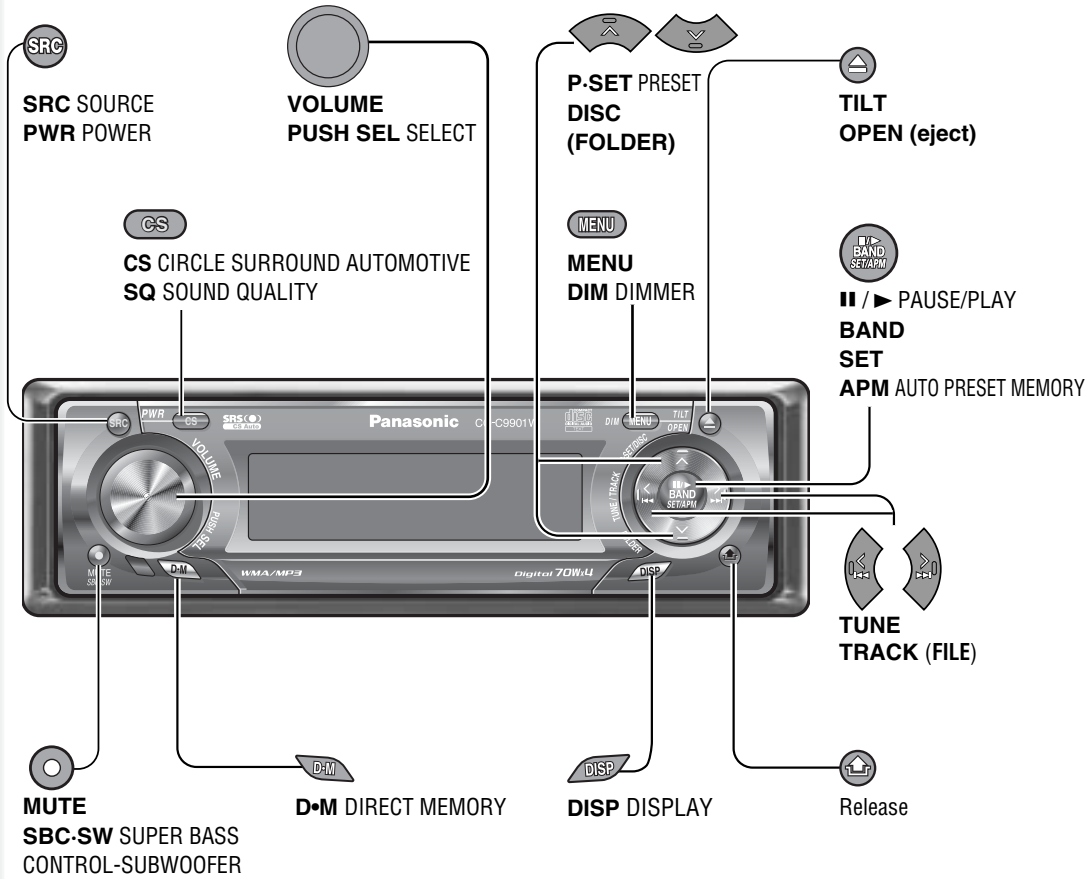

When Panel Opens

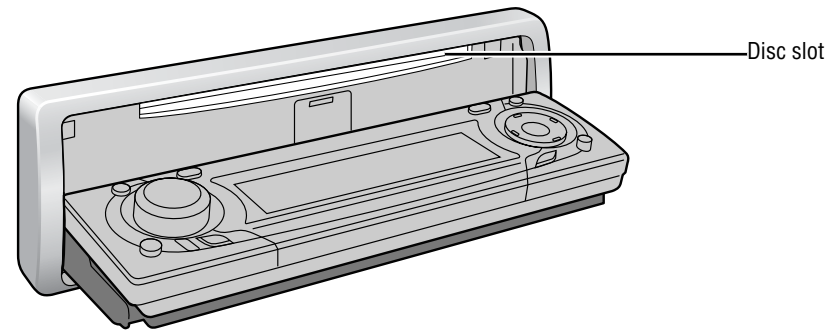

Remote Control Unit

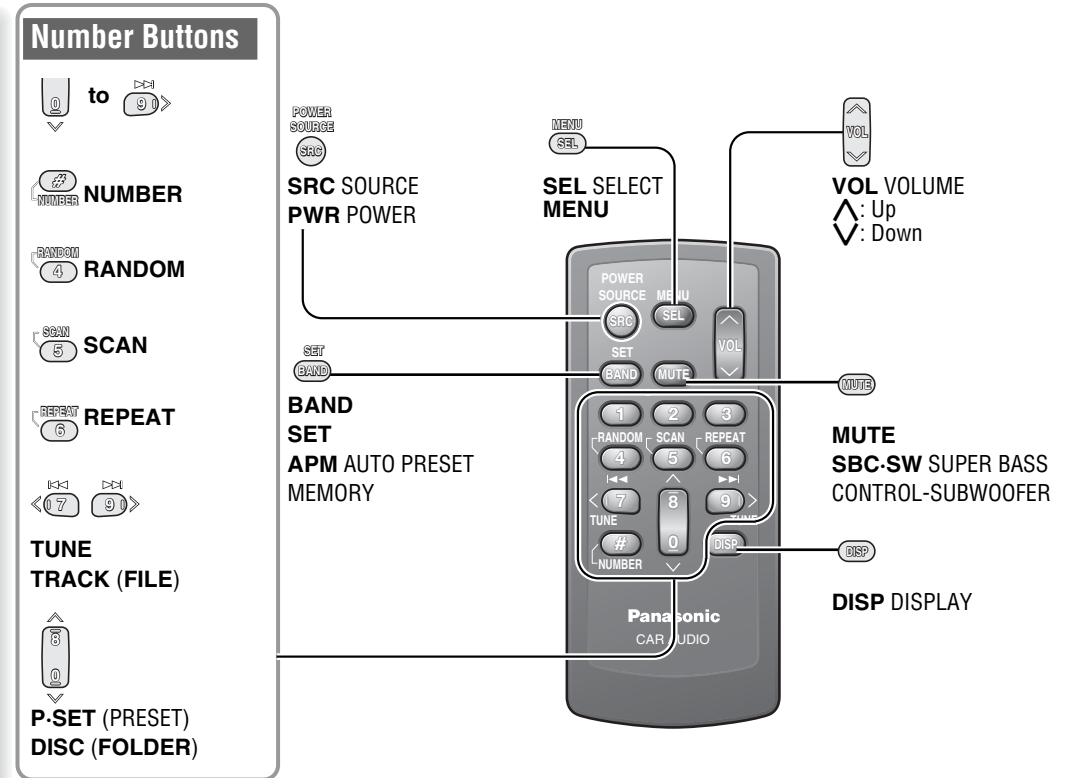

One-touch operation is available for selecting a track playing style by use of [4] (RANDOM), [5] (SCAN), or [6] (REPEAT). (For a Folder/Disc playing style, hold down the same button for 2 sec. or more.)

Direct Access

A track (CD mode), disc (Disc changer), file and folder (MP3/WMA mode) can be directly selected.

Example: Track number 5

- 1 Press [#] (NUMBER).
- 2 Press [5].
- 3 Press [BAND] (SET).

Functions only by remote control unit

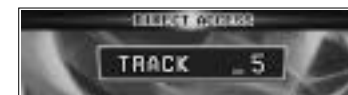

English
Controls Layout

When the power is switched on for the first time, a demonstration message appears on the display. Press [DISP] to change to regular mode.

- 1 Set your car's ignition switch to the ACC or ON position.
The demonstration screen appears.

Example: CQ-C9901W



- 2 Press [DISP: DISPLAY].
The demonstration screen is cancelled, and no more appears.

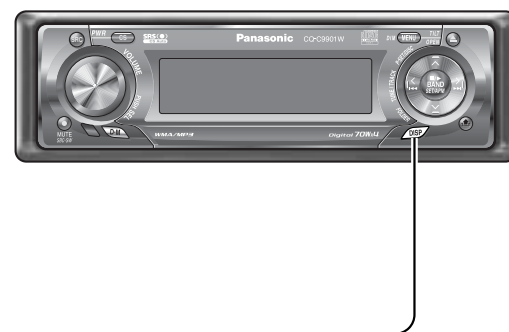

Note: If you would like to turn on the power and make the demonstration message appear, hold down [SRC] (PWR: POWER) for 4 sec. or more.

Preparation Before Initial Use

Pull the insulation film out from the backside of remote control gently.

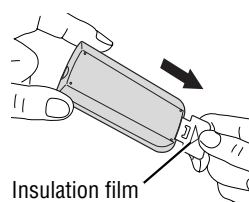

Insulation film

Battery Replacement

- 1 Remove the battery holder with the remote control unit placed on a flat surface.
 - 1 Stick your thumbnail into the groove, and push the holder in the direction of the arrow, and at the same time.
 - 2 Pull it out in the direction of the arrow using a tough pointed object.
- 2 Put a battery in the case with (+)-side facing up.
- 3 Put the case back.

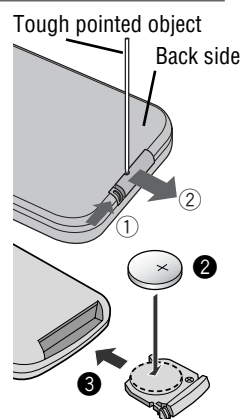

Warning

- Keep batteries and insulation film out of reach of infants. If an infant ingests a battery, please seek immediate medical attention.

Caution

- Remove and dispose of an old battery immediately.
- Do not disassemble, heat or short a battery. Do not throw a battery into a fire or water.
- Follow local regulations when disposing of a battery.
- Improper use of a battery may cause overheating, an explosion or ignition, resulting in injury or a fire.

Note:

- **Battery Information:**
Battery Type: Panasonic lithium battery (CR2025) (Included in the remote control)
Battery Life: Approximately 6 months under normal use (at room temperature)

- The alarm sounds and the message appears on the screen to warn you to remove the face plate at power off.

The following functions are activated when the Security Function is ON. (→ page 34)

- The security indicator blinks when removing the face plate.

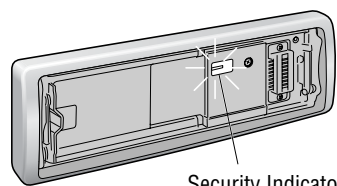

Security Indicator



You may need to set the following depending on the devices to be connected.

Using Subwoofer

- Subwoofer level adjustment (→ page 32)
- Subwoofer low pass filter (→ page 32)

Connecting an AV device (TV, VTR)

If you connect TV to AUX1 terminal, set the AUX1 setting to TV.

- 1 Press [SRC: SOURCE] to select the AUX1 mode. (→ page 14)
- 2 Press [MENU] to display the menu display.
For using the remote control, hold down [MENU] for 2 sec. or more.



- 3 Press [BAND] (SET) to adjust.

TV : TV

AUX : Other devices (Default)

Note: When using an external TV unit manufactured by a third party, select the **TV** mode.

- 4 Press [MENU] to confirm the adjustment.

Note: Adjust the clock when "ADJUST" appears on the display.

- 1 Press [MENU] to display the menu display.
For using the remote control, hold down [MENU] for 2 sec. or more.
- 2 Press [<] or [>] to display the DISPLAY menu.
- 3 Press [V] to select "CLOCK ADJ".
- 4 Press [BAND] (SET) to confirm the display.

- 5 Adjust the setting value.



[>]: Adjusting minutes
[<]: Adjusting hours
[^]: Forward
[v]: Backward



- 6 Press [BAND] (SET) to confirm the adjustment.

Note: For cancellation of clock adjustment, press [DISP].

- 7 Press [MENU].
For using the remote control, hold down [MENU] for 2 sec. or more.

This chapter explains how to turn on or off the power, how to adjust the volume, etc.

Power on

Press [SRC] (PWR: POWER).



Notes:

- The opening screen appears. You can overwrite the opening screen (moving picture) with new one. (→ page 36)
- When the power is switched on for the first time, a demonstration message appears on the display. Press [DISP] to change to regular mode. (→ page 10)

Power off

Hold down [SRC] (PWR: POWER) for 2 sec. or more and release it.

Note: The ending screen appears. You can overwrite the ending screen (moving picture) with new one. (→ page 36)

You can remove the face plate to prevent it from being stolen.



3 Put the face plate in the case.

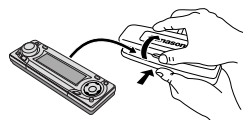

Removing

- 1 Turn off the power (→ page 12)
- 2 Press [RE] (Release).
(The face plate disengages with a click when it is removed.)



The face plate automatically closes in 5 seconds if it is open or tilted.

Note: The power is automatically turned off while the unit is active.

Mounting

- 1 Slide the left side of the face plate in place.
- 2 Press the right end of the face plate until "click" is heard.

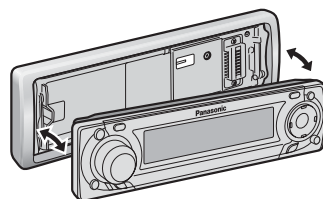

Caution

- It is recommended to remove or mount the face plate when the plate is at the closed position. Do not remove or mount the face plate when the plate is in motion.
- This face plate is not waterproof. Do not expose it to water or excessive moisture.
- Do not remove the face plate while driving your car.
- Do not place the face plate on the dashboard or nearby areas where the temperature rises to high levels.
- Do not touch the contacts on the face plate or on the main unit, since this may result in poor electrical contacts.
- If dirt or other foreign substances get on the contacts, wipe them off with clean and dry cloth.
- To avoid damaging the face plate, do not push it down or place objects on it while it is open.

Open/Eject

Press [OPEN].

When a disc is already loaded, the disc will automatically be ejected.

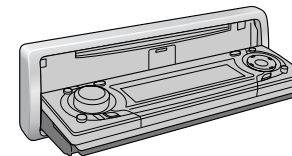

Caution

- To avoid damaging the face plate, do not push it down or place objects on it while it is open.
- Do not pinch your finger or hand in the face plate.
- Do not insert foreign objects into the disc slots.
- For the following cases, the face plate automatically closes. Use caution not to catch your finger.
 - After a lapse of 20 seconds
 - When a disc is inserted
 - When the face plate is removed (→ page 12)
 - Five seconds after turning off the power or turning the key to ACC OFF.

Close

Press [OPEN].

Tilt

The display angle changes among 4 levels as follows every time you hold down [TILT] for 1 sec. or more and release.

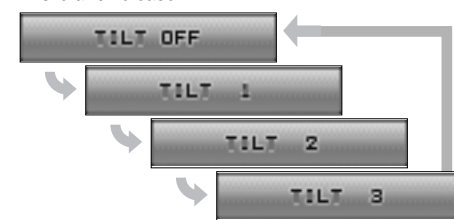

Note: The last selected angle is maintained even after turning off the power.

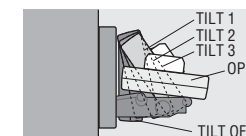

- 1 Up
- 2 Down

Setting Range: 0 to 40
Default: 18

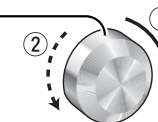

Notes:

- The volume level can be set independently for each source. (For radio, one volume setting for AM, one volume setting for all FMs)
- The volume is not adjustable while an error appears on the monitor or the external mute function is enabled. (→ page 42)

Volume off (down)

Press [MUTE].



Cancel

Press [MUTE] again.

Note: Volume-down range can be specified. (→ page 34)



The source changes as follows every time [SRC: SOURCE] is pressed.



Radio

FM1, FM2, FM3, AM (→ page 19)



Player

When loading CD (→ page 22)



When loading MP3/WMA disc (→ page 24)

Auxiliary (AUX 1)

When connecting a TV



When connecting a device that is not compatible with this unit

Auxiliary (AUX2)

When connecting CD Changer, DVD Changer (→ page 28, 30)



When connecting a device that is not compatible with this unit

Notes: Please connect a CD changer or a DVD changer to AUX2. (→ Installation Instructions)

The display changes as follows every time [DISP: DISPLAY] is pressed.

Note: You can select a graphic pattern and a still image from originally stored data. (→ page 35) You can also use your original images. (Customize Function → page 36)



At power-on:

Mode



Display OFF

All displays disappear in 5 seconds.



Folder hierarchy (MP3/WMA mode only.)



Ordinary display + clock

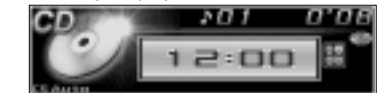

Display Change
(DISP: DISPLAY)

Ordinary display + graphic pattern

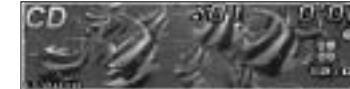

Only still image



Only graphic pattern



Ordinary display + still image



At power-off:

Clock display (default)



Off

Dimmer Control
(DIM: DIMMER)

The dimmer level changes as follows every time you hold down [MENU] (DIM: DIMMER) for 2 sec. or more.

Brighter (Default)



Medium



Darker



Note: This setting is not adjustable with the remote control.

CS Auto allows your car interior to change to a splendid audio room in a moment. Every speaker can be fine-tuned.

You can toggle the CS Auto function on and off every time you press **[CS: CIRCLE SURROUND AUTOMOTIVE]**. Select CS Auto on or off after setting each item.

Note: If you enable CS Auto, the following functions are automatically disabled:
SQ, POSITION, BASS/TREBLE, BALANCE/FADER, SUBWOOFER LEVEL, LPF, HPF, SBC-SW



Lights when CS Auto is activated.

You have six preset modes (FLAT, POP, ROCK, VOCAL, JAZZ, CLUB).

SQ9 (9-Band Sound Quality)

Center frequency and level are adjustable in each of nine bands. This lets you fine tune sound quality for each genre to suit car-interior acoustics and your personal preferences.

You can toggle the SQ function on and off every time you press **[CS]** (SQ).

Notes:

- Each SQ level is changeable. (⇒ page 18)
- If you enable SQ, the following functions are automatically disabled:
CS Auto, F-TruBass, R-TruBass, S.W.-TruBass, F-Focus, R-Focus, F-R MIX



Lights when SQ is activated.
(Hidden in the FLAT mode)

SBC-SW: SUPER BASS CONTROL-SUBWOOFER

The rear speaker can be used as a substitutional subwoofer when a subwoofer is not connected.

Holding down **[SBC-SW]** for 2 sec. or more toggles SBC-SW on and off.



Off (default)



On



Lights when SBC-SW is activated.

Notes:

- If ON is selected, the settings of subwoofer level adjustment and subwoofer low pass filter are activated. (⇒ page 32)
- When SBC-SW is set to ON, the CS mode automatically turns off.

You can optimize the performance of CS Auto (Circle Surround Automotive) by following the steps below.

- 1 Set the CS Auto mode to on.
- 2 Hold down **[CS]** for 2 sec. or more to display the audio menu display.

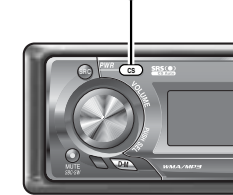

- 3 Press **[BAND]** (**SET**) to adjust.



- 4 Press **[DISP]** to confirm the adjustment.



CS AUTO MODE

Three-dimensional natural sound field is reproduced with clarity in response to sound.

- MUSIC:** Music
(default in other than the AM mode)
- CINEMA:** Cinema
- MONO:** Monaural (default in the AM mode)

You can make a fine adjustment of SQ and Position.

- 1 Set the SQ mode to on.
- 2 Hold down [CS] (SQ) for 2 sec. or more to display the audio menu display.



- 3 Press [^] or [v] to select a function to be adjusted.

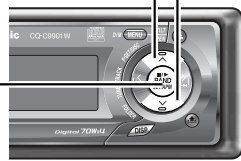

- 4 Press [BAND] (SET) to adjust.

- 5 Adjust the setting value.

[^][v][<][>]: Select
[BAND](SET): Confirm

- 6 Press [DISP] to confirm the adjustment.



SQ PRESET SELECT

Select your favorite type from 6 kinds of SQ Presets.

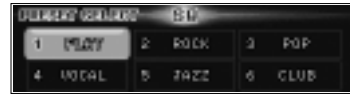

Note: You can also select the SQ preset number by pressing [1] to [6] on the remote control.

SQ ADJUSTMENT (SQ9)

You can make a fine adjustment to the currently selected SQ presetting in each type (except FLAT).



[<][>]: Frequency band selection
①②: Frequency selection
[^][v]: Level up/down

Note: If you hold down [BAND] for 2 sec. or more, the presetting that is called up can be turned into the default.

SQ PRESET MEMORY

The current value is assigned to one of SQ preset 2 to 6.



- 1 Select a preset number by pressing [^], [v], [<] or [>].

- 2 Hold down [BAND] for 2 sec. or more.

Note: You can also select the SQ preset number by pressing [2] to [6] on the remote control, and assign the current value to the selected preset number by holding down the same button for 2 sec. or more.

POSITION

You can make the optimal sound field in accordance with your seat.



A radio DSP is integrated into this unit. The IF filter allows the radio to adjust the bandwidth automatically to maintain optimum reception.

- 1 Press [SRC: SOURCE] to select the radio mode.

- 2 Press [BAND] to select a band.

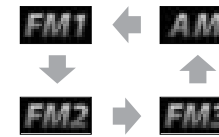

- 3 Select a station.

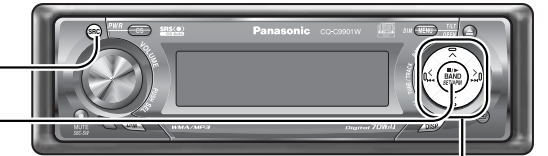

Frequency adjustment

[<] (TUNE): Lower
[>] (TUNE): Higher

Note: Hold down for 0.5 sec. or more and release for station search.

Preset station selection

[v] (P-SET: PRESET): Lower preset number
[^] (P-SET: PRESET): Higher preset number

Notes:

- Direct Access can be executed with [1] to [6] buttons on remote control.
- Stations in FM 1 to 3 are sequentially selectable without changing bands when "ALL BAND" is selected in "AUTO PRESET".

Notes:

- For tuning in on only stations whose receiving conditions are good in the station search, set LOCAL to ON. (→ page 21)
- For reducing noise when a receiving FM stereo wave is weak, set FM MONO to ON. (→ page 21)

Diagram of the radio mode display showing the following elements:

- Preset Number:** Points to the 'P-SET' indicator.
- Band:** Points to the 'FM1' indicator.
- Frequency:** Points to the '92.50 MHz' display.
- Intensity:** Points to the signal strength indicator (a bar with a scale).
- STEREO:** A light indicator that lights while receiving an FM stereo signal. ("STEREO": CQ-C9801W)
- MONO:** A light indicator that lights when MONO is activated. (→ page 21)
- LOCAL:** A light indicator that lights when LOCAL is activated. (→ page 21)

You can assign your favorite broadcasting station to the **[D-M]** button. As the result of doing that, your favorite broadcasting station can be received even if the CD mode or the CD changer mode is activated.
(Default: FM 87.50 MHz)

Note: For the use of an FM transmitter, it is useful for users to register applicable frequencies on D-M (Direct Memory).

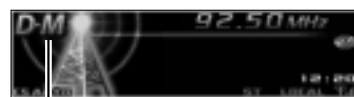

Lights when the **D-M** mode is activated.

D-M station calling

1 Press **[D-M: DIRECT MEMORY]**.

D-M station writing

- 1 Select a station you would like to preset.
- 2 Hold down **[D-M: DIRECT MEMORY]** for 2 sec. or more.

Manual station preset

- 1 Tune in to a station.
- 2 Hold down **[^]** or **[v]** for 2 sec. or more.
- 3 Select a preset number by pressing **[^]** or **[v]**.
- 4 Preset the station by holding down **[^]** or **[v]** for 2 sec. or more.



Frequency/preset number blinks once.

Notes:

- New stations overwrite existing saved stations.
- In step 2, a station can be registered by holding down the numeric button **[1]** to **[6]** for 2 sec. or more.
- To stop presetting stations, press **[DISP]** (Display).

Up to 6 stations can be preset in AM, FM1, FM2, and FM3 respectively.

Preset stations can be simply called up by pressing **[^]** (**P-SET**) or **[v]** (**P-SET**).

Notes:

- Direct Access can be executed with **[1]** to **[6]** buttons on remote control.
- You can switch between 6 and 18 for FM presetting stations. (→ page 21)
- Preset stations are changeable. (→ page 21)

Auto Preset Memory (APM)

Stations with good receiving conditions are automatically preset.

- 1 Select a band.
- 2 Hold down **[BAND]** (**APM**) for 2 sec. or more.



The preset stations under best receiving conditions are received for 5 sec. each after presetting the stations (SCAN). To stop scanning, press **[^]** or **[v]**.

Note: New stations overwrite existing saved stations.

In the AM mode, only NOISE SUPPRESSION and LOCAL can be selected.

1 Press **[MENU]** to display the menu display.

For using the remote control, hold down **[MENU]** for 2 sec. or more.



2 Press **[^]** or **[v]** to select a mode to be adjusted.

3 Press **[BAND]** (**SET**) to adjust.

4 Press **[MENU]** to confirm the adjustment.

For using the remote control, hold down **[MENU]** for 2 sec. or more.



MONO (Monaural)

Noise reduction when the signal strength decreases

- OFF**: Receiving in stereo (default)
- ON**: Receiving in mono and reducing the noise level

LOCAL

Setting when searching for a station

- OFF**: Searching even for a relatively low-intensity radio wave station (default)
- ON**: Searching only for a high-intensity radio wave station

NOISE SUPPRESSION

IF filter setting for noise suppression

- WIDE**: Wide range
- MID**: Middle range (default)
- NARROW**: Narrow range

AUTO PRESET

You can select 6 or 18 stations for FM presetting with the use of APM.

ALL BAND:

Preset 6 stations to FM1 to FM3 respectively, that is, 18 stations in total at the same time. This function is useful for presetting more than 6 stations. (default)

EACH BAND:

Preset 6 stations with good reception to the selected band from FM1 to FM3. This function is useful for presetting stations in different areas in different bands.

PRESET EDIT

You can arrange the order of the preset stations. Preset stations can be reordered as you like after executing APM or the like.

1 Press **[^]**, **[v]**, **[<]** or **[>]** to select one station to be interchanged.

2 Press **[BAND]** to confirm your selection.

3 Press **[^]**, **[v]**, **[<]** or **[>]** to select the other station to be interchanged.

4 Press **[BAND]** to confirm your selection.

●Calling an FM station registered on D-M

RADIO AUDIO FILTER

You can select the reception status (band) of FM stations registered on D-M.

THROUGH: Off (default)

HC 1: High cut level 1

HC 2: High cut level 2 (same processing at receiving an FM station)

When a disc is already loaded, press [SRC: SOURCE] to select the CD mode.

1 Press [⊖] (OPEN) to open the face plate.

When a disc is already loaded (Ⓛights), the disc will automatically be ejected.

2 Load a disc with the label-side facing up. The face plate closes automatically, and the unit recognizes the disc and starts playing automatically, too.

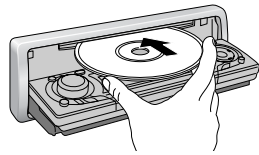

3 Select a desired track.

Track selection

[▶▶] (TRACK): Next track
[◀◀] (TRACK): Preceding track (press twice)
Note: Hold down for fast forward/reverse.

Pause

Press [BAND] (⏸/▶).
Press again to cancel.

4 Press [⊖] (OPEN/eject) to eject the disc.



CD-TEXT display

Notes:

- For scrolling text, hold down [DISP] for 2 sec. or more.
- "NO TEXT" is displayed when there is no information on the disc.

Lights when each mode is activated.



Lights when the disc is loaded.

(RANDOM, REPEAT)

Caution

- **This unit does not support 8 cm discs.**
- Do not use irregularly shaped discs. (⇒ page 43)
- Do not use discs that have a seal or label attached.
- To avoid damaging the face plate, do not push it down or place objects on it while it is open.
- Do not pinch your finger or hand in the face plate when the panel is in motion.
- Do not insert foreign matter into the disc slots.
- Refer to the section on "Notes on CD/CD Media (CD-ROM, CD-R, CD-RW)" (⇒ page 43).
- This unit does not support a MIX mode CD (a CD containing both CD-DA and MP3/WMA data). In case of using such a CD, problems may occur such as an acoustic playback.

Random and Repeat play can be set.

1 Press [MENU] to display the menu display.

For using the remote control, hold down [MENU] for 2 sec. or more.



2 Press [∧] or [∨] to select a mode to be adjusted.

3 Press [BAND] (SET) to adjust.

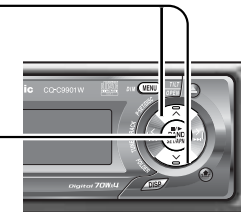

4 Press [MENU] to confirm the adjustment.

For using the remote control, hold down [MENU] for 2 sec. or more.



RANDOM

- OFF: Off (default)
- ON: Random playback

REPEAT

- OFF: Off (default)
- ON: Playing the current track repeatedly

TEXT

- Text display
- ON: Enabled (default)
 - OFF: Disabled

Play Mode Selection

One-touch operation is available for selecting a track playing style by use of [RANDOM] or [REPEAT].

RANDOM

Press [RANDOM].
Press again to cancel.

REPEAT

Press [REPEAT].
Press again to cancel.

SCAN play

You can find your favorite track by playing first 10-sec. of each track.
Press [SCAN].
Press again to cancel.

Direct Access

A track can be directly selected.

Example: track number 5

1 Press [#] (NUMBER).

2 Press [5].

3 Press [SET].

Note: To suspend direct selection, press [DISP].



When a disc is already loaded, press **[SRC: SOURCE]** to select the CD mode.

1 Press **[OPEN]** to open the face plate.

When a disc is already loaded (lights), the disc will automatically be ejected.

2 Load a disc with the label-side facing up. The face plate closes automatically, and the unit recognizes the disc and starts playing automatically, too. (It may take several minutes to start for a disc that has a lot of files.)

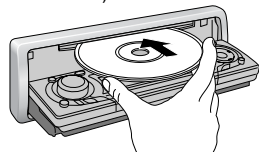

3 Select a desired folder/file.

Folder selection

[^] (FOLDER): Next folder
[v] (FOLDER): Preceding folder

File selection

[>>] (TRACK): Next file
[<<] (TRACK): Preceding file (press twice)

Note: Hold down for fast forward/reverse.

Pause

Press **[BAND]** (||/▶).
 Press again to cancel.

4 Press **[OPEN/eject]** to eject the disc.

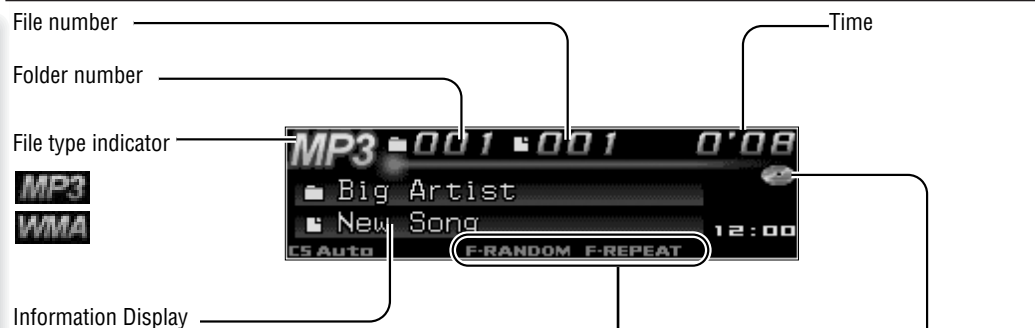

Notes:

- For scrolling text, hold down **[DISP]** for 2 sec. or more.
- "NO TEXT" is displayed when there is no information on the disc.
- ID3/WMA tag information is displayed for the album name and title/artist name.

Play Mode indicators
 Lights when each mode is activated.

- RANDOM**
- REPEAT**
- SCAN**
- F-RANDOM** (Folder Random)
- F-REPEAT** (Folder Repeat)
- F-SCAN** (Folder Scan)

Lights when the disc is loaded.

Notes:

- Refer to the section on "Notes on MP3/WMA" (→ page 26)

- This unit does not support a MIX mode CD (a CD containing both CD-DA and MP3/WMA data). In case of using such a CD, problems may occur such as an acoustic playback.

Random and Repeat play can be set.

1 Press **[MENU]** to display the menu display.

For using the remote control, hold down **[MENU]** for 2 sec. or more.



2 Press **[^]** or **[v]** to select a mode to be adjusted.

3 Press **[BAND]** (**SET**) to adjust.

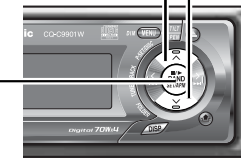

4 Press **[MENU]** to confirm the adjustment.

For using the remote control, hold down **[MENU]** for 2 sec. or more.



RANDOM

- OFF**: Off (default)
- ON**: Random playback (from whole disc)

FOLDER RANDOM

- OFF**: Off (default)
- ON**: Random playback (from selected folder)

REPEAT

- OFF**: Off (default)
- ON**: Playing the current file repeatedly

FOLDER REPEAT

- OFF**: Off (default)
- ON**: Playing the current folder repeatedly

TEXT

- FOLDER/FILE**: Folder name/File name (default)
- ALBUM/TITLE**: Album/Title (tag information)
- OFF**: No display

Play Mode Selection

One-touch operation is available for selecting a file playing style by use of **[RANDOM]** or **[REPEAT]**.

RANDOM, REPEAT

Press the button. Press again to cancel.

FOLDER RANDOM, FOLDER REPEAT

Hold down the button for 2 sec. or more. Hold down again to cancel.

SCAN play

You can find your favorite file by playing first 10-sec. of each file.

SCAN (All files)

Press **[SCAN]**. Press again to cancel.

FOLDER SCAN (1st file in each folder)

Hold down **[SCAN]** for 2 sec. or more. Hold down again to cancel.

Direct Access

A file in the current folder can be directly selected.

Example: file number 5

- 1 Press **[#]** (**NUMBER**).
- 2 Press **[5]**.
- 3 Press **[SET]**.

Notes:

- For folder selection, enter a number after pressing **[#]** (**NUMBER**) twice.
- If there is no playable file in the selected folder, the first file or folder on the disc is selected.
- To suspend direct selection, press **[DISP]**.



What is MP3/WMA?

MP3 (MPEG Audio Layer-3) and WMA (Windows Media™ Audio) are the compression formats of digital audio. The former is developed by MPEG (Motion Picture Experts Group), and the latter is developed by Microsoft Corporation. Using these compression formats, you can record the contents of about 10 music CDs on a single CD media (This figures refer to data recorded on a 650MB CD-R or CD-RW at a fixed bit rate of 128 kbps and a sampling frequency of 44.1 kHz).

Notes:

- MP3/WMA encoding and CD writing software programs are not supplied with this unit.
- CD writing software is not supplied with this unit.

Points to remember when making MP3/WMA files

Common

- High bit rate and high sampling frequency are recommended for high quality sound.
- Selecting VBR (Variable Bit Rate) is not recommended because playing time is not displayed properly and sound may be skipped.
- The playback sound quality differs depending on the encoding circumstances. For details, refer to the user manual of your own encoding software and writing software.

MP3

- It is recommended to set the bit rate to "128 kbps or more" and "fixed".

WMA

- It is recommended to set the bit rate to "64 kbps or more" and "fixed".
- Do not set the copy protect attribute on the WMA file to enable this unit to play back.

⚠ Caution

Never assign the ".mp3", or ".wma" file name extension to a file that is not in the MP3/WMA format. This may not only produce noise from the speaker damage, but also damage your hearing.

Display Information

Displayed items

- | | |
|------------------|------------------------|
| • CD-TEXT | • MP3 (ID3 tag) |
| Disc title | Album name |
| Track title | Title name/Artist name |
| • MP3/WMA | • WMA (WMA tag) |
| Folder name | Album name |
| File name | Title name/Artist name |

Displayable characters

- Displayable length of file name/folder name: within 64 characters.
- Name files and folders in accordance with the standard of each file system. Refer to the instructions of writing software for details.
- ASCII character set and special characters in each language can be displayed.

ASCII character set

A to Z, a to z, digits 0 to 9, and the following symbols:
 (space) ! " # \$ % & ' () * + , - . / : ; < = > ? @ [\] ^ _ ` { | } ~

Notes:

- With some software in which MP3/WMA format files have been encoded, the character information may not be displayed properly.
- Undisplayable characters and symbols will be converted into an asterisk (*).
- It is recommended that the length of the file name is less than 8 (excluding the file extension).

Recording MP3/WMA files on a CD-media

- **You are recommended to minimize the chances of making a disc that contains both CD-DA files and MP3/WMA files.**
- **If CD-DA files are on the same disc as MP3 or WMA files, the songs may not play in the intended order, or some songs may not play at all.**
- **When storing MP3 data and WMA data on the same disc, use different folders for each data.**
- Do not record files other than MP3/WMA files and unnecessary folder on a disc.
- The name of MP3/WMA file should be added by rules as shown in the following descriptions and also comply with the rules of each file system.
- The file extension ".mp3" or ".wma" should be assigned to each file depending on the file format.
- You may encounter trouble in playing MP3/WMA files or displaying the information of MP3/WMA files recorded with certain writing software or CD recorders.
- This unit does not have the play list function.
- Although Multi-session recording is supported, the use of Disc-at-Once is recommended.

Supported file systems

ISO 9660 Level 1/Level 2, Apple Extension to ISO 9660, Joliet, Romeo

Note: Apple HFS, UDF 1.50, MIX mode CD, CD Extra are not supported.

Compression formats

(Recommendation: "Points to remember when making MP3/WMA files" on the previous page)

Compression method	Bit rate	VBR	Sampling frequency
MPEG 1 audio layer 3 (MP3)	32 k-320 kbps	Yes	32, 44.1, 48 kHz
MPEG 2 audio layer 3 (MP3)	8 k-160 kbps	Yes	16, 22.05, 24 kHz
Windows Media Audio Ver. 2, 8	64 k-192 kbps	No	32, 44.1, 48 kHz

Folder selection order/file playback order

Maximum number of files/folders

- Maximum number of files: 999
- Maximum number of files in one folder: 255
- Maximum depth of trees: 8
- Maximum number of folders: 255 (Root folder is included.)

Notes:

- This unit counts the number of folders irrespective of the presence or absence of MP3/WMA file.
- If the selected folder does not contain any MP3/WMA files, the nearest MP3/WMA files in the order of playback will be played.
- Playback order may be different from other MP3/WMA players even if the same disc is used.
- "ROOT" appears when displaying the root folder name.

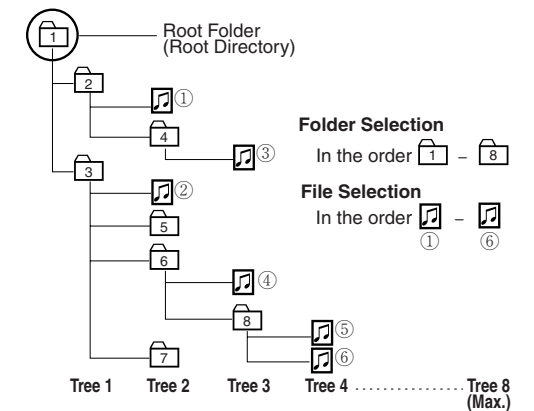

Windows Media, and the Windows logo are trademarks, or registered trademarks of Microsoft Corporation in the United States and/or other countries.



Copyright

It is prohibited by copyright laws to copy, distribute and deliver copyrighted materials such as music without the approval of copyright holder except enjoying yourself personally.

No warranty

Above description complies with our investigations as of December 2004. It has no warranty for reproducibility and displayability of MP3/WMA.

Disc Changer (when CDs or MP3 discs are loaded)

Note: MP3 files are playable only when a DVD changer is connected. Please refer to the operating instructions for each changer regarding applicable discs and formats.

1 Load a magazine (discs).

When a magazine is already loaded (lights), press **[SRC: SOURCE]** to select the changer mode.

The unit recognizes the magazine and starts playing automatically.

Note: The changer is automatically turned on when the magazine is inserted.

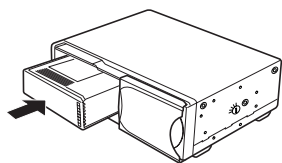

2 Select a desired disc/folder/file/track.

Disc selection

[^]: Next disc
[v]: Preceding disc

Folder selection

Hold down for 2 sec. or more.
[^] (**FOLDER**): Next folder
[v] (**FOLDER**): Preceding folder

Track/File selection

[>>]: Next track/file
[<<]: Preceding track/file (press twice)

Note: Hold down for fast forward/reverse.

Pause

Press **[BAND] (||/▶)**.
Press again to cancel.

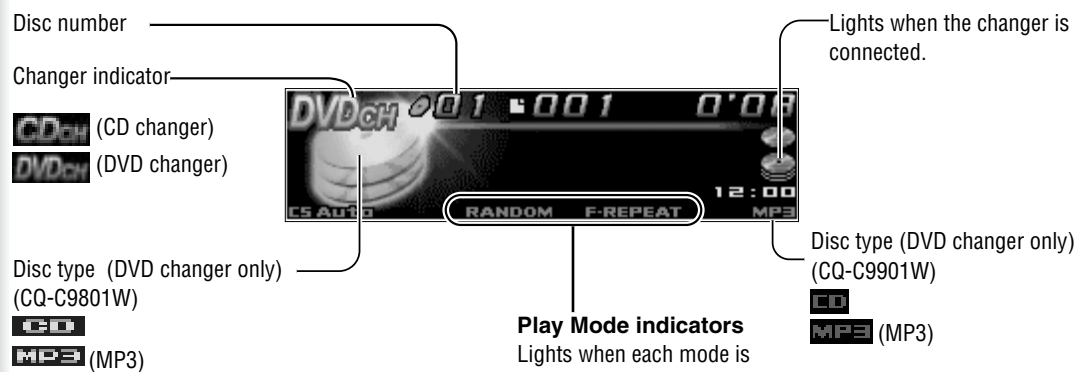

RANDOM

REPEAT

SCAN

F-REPEAT (Folder Repeat)

D-RANDOM (Disc Random) CD changer only

D-REPEAT (Disc Repeat)

D-SCAN (Disc Scan) CD changer only

Notes:

- Please connect a CD changer or a DVD changer (CX-DH801W) to **CH/AUX2**.
- When CX-DP880 or CX-DH801W is connected, a CD-RW disc is playable.

- Trouble may occur while playing CD-Rs. Refer to the section on "Notes on CD/CD Media (CD-ROM, CD-R, CD-RW)" (→ page 43).

Random and Repeat play can be set.

1 Press [MENU] to display the menu display.

For using the remote control, hold down **[MENU]** for 2 sec. or more.



2 Press [^] or [v] to select a mode to be adjusted.

3 Press [BAND] (SET) to adjust.

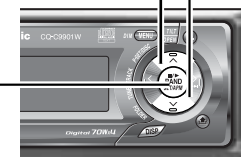

4 Press [MENU] to confirm the adjustment.

For using the remote control, hold down **[MENU]** for 2 sec. or more.



Play Mode Selection

One-touch operation is available for selecting a track playing style by use of **[RANDOM]** or **[REPEAT]**.

RANDOM, REPEAT

Press the button. Press again to cancel.

DISC RANDOM, DISC REPEAT, FOLDER REPEAT

Hold down the button for 2 sec. or more. Hold down again to cancel.

SCAN play

You can find your favorite track by playing first 10-sec. of each track.

SCAN (CD changer: All tracks, DVD changer: From selected disc)

Press **[SCAN]**. Press again to cancel.

RANDOM

- CD-DA**
RANDOM playback of the selected disc (DVD changer)
RANDOM playback of all discs in the magazine (CD changer)
- MP3 disc**
RANDOM playback of the selected folders

OFF: Off (default)

ON: Random playback

DISC RANDOM (only for CD changer)

OFF: Off (default)

ON: Random playback (from selected disc)

REPEAT

OFF: Off (default)

ON: Playing the current track/file repeatedly

DISC REPEAT (only for CD-DA disc)

OFF: Off (default)

ON: Playing the current disc repeatedly

FOLDER REPEAT (only for MP3 disc)

OFF: Off (default)

ON: Playing the current folder repeatedly

DISC SCAN (CD changer: 1st track in each disc)

Hold down **[SCAN]** for 2 sec. or more. Hold down again to cancel.

Direct Access

A disc can be directly selected.

Example: disc number 5

1 Press **[#] (NUMBER)**.

2 Press **[5]**.

3 Press **[SET]**.

Note: To suspend direct selection, press **[DISP]**.



Disc Changer (when DVDs or VCDs are loaded)

You can play DVDs or VCDs when connecting this unit to DVD changer.

1 Load a magazine (discs).

When a magazine is already loaded (lights), press **[SRC: SOURCE]** to select the DVD changer mode.

The unit recognizes the magazine and starts playing automatically.

Note: The changer is automatically turned on when the magazine is inserted.

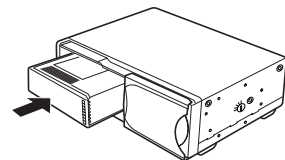

Notes:

- For DVD operations other than the above (i.e. DVD menu, closed caption, etc.), use the remote control unit supplied with the DVD changer.
- The remote control unit supplied with the DVD changer does not work properly when you aim it at this unit.
- When using the remote control unit supplied with the DVD changer, aim it at the monitor display (CY-VM1500EX).



2 Select a desired disc/chapter.

Disc selection

- [^]**: Next disc
- [v]**: Preceding disc

Chapter/Track selection

- [>>]**: Next chapter/track
- [<<]**: Preceding chapter/track (press twice)

Note: Hold down for fast forward/reverse.

Pause

Press **[BAND] (|| / >)**.
Press again to cancel.

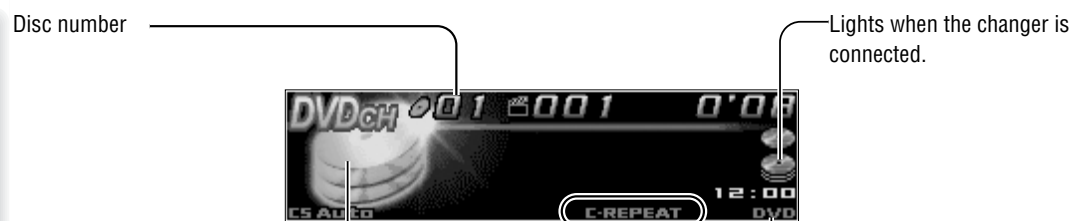

Disc number

Lights when the changer is connected.

Disc type (DVD changer only) (CQ-C9801W)

Disc type (DVD changer only) (CQ-C9901W)



Play Mode indicators
Lights when each mode is activated.

- REPEAT**
- D-REPEAT** (Disc Repeat)
- C-REPEAT** (Chapter Repeat)
- T-REPEAT** (Title Repeat)

Notes:

- Please connect a CD changer or a DVD changer (CX-DH801W) to **CH/AUX2**.
- "AUX2" is displayed when connecting a changer that is not compatible with this unit.

Repeat play can be set.

1 Press [MENU] to display the menu display.

For using the remote control, hold down **[MENU]** for 2 sec. or more.



2 Press [^] or [v] to select a mode to be adjusted.

3 Press [BAND] (SET) to adjust.

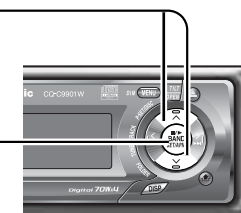

4 Press [MENU] to confirm the adjustment.

For using the remote control, hold down **[MENU]** for 2 sec. or more.



●DVD playing

CHAPTER REPEAT

- OFF**: Off (default)
- ON**: Playing the current chapter repeatedly

TITLE REPEAT

- OFF**: Off (default)
- ON**: Playing the current title repeatedly

Note: The unit may not operate for some DVDs.

●VCD playing

REPEAT

- OFF**: Off (default)
- ON**: Playing the current track repeatedly

DISC REPEAT

- OFF**: Off (default)
- ON**: Playing the current disc repeatedly

Notes:

- The unit may not operate for some VCDs.
- The unit may not operate for a disc with the play back function activated.

Play Mode Selection

One-touch operation is available for selecting a track playing style by use of **[REPEAT]**.

CHAPTER REPEAT, REPEAT

Press the button. Press again to cancel.

TITLE REPEAT, DISC REPEAT

Hold down the button for 2 sec. or more. Hold down again to cancel.

Direct Access

A disc can be directly selected.

Example: disc number 5

- 1 Press **[#] (NUMBER)**.
- 2 Press **[5]**.
- 3 Press **[SET]**.



Note: To suspend direct selection, press **[DISP]**.

Audio Setting

Adjustment to each speaker and an optional subwoofer

Audio Setting (when CS Auto deactivated)

- 1 Set the CS Auto mode to off. (→ page 16)

- 2 Press [VOLUME] (SEL: SELECT) to display the menu display.



- 3 Press [VOLUME] (SEL: SELECT) to select a mode to be adjusted.

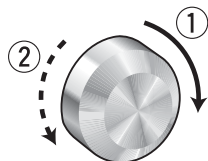

- 4 Turn [VOLUME] clockwise or counterclockwise to adjust.

Note: If no operation takes place for more than 10 sec. in the audio menu (2 sec. in Main volume adjustment), the display returns to the regular mode.

Main volume adjustment

(Setting range: 0 to 40, Default: 18)

- 1 : Up
- 2 : Down



BASS

(Setting range: -12 dB to +12 dB, 2 dB step, Default: Bass 0)

- 1 : Up
- 2 : Down



TREBLE

(Setting range: -12 dB to +12 dB, 2 dB step, Default: Treble 0)

- 1 : Up
- 2 : Down



Note: Do not activate SQ and Bass/Treble at the same time to avoid causing sound distortion.

Balance adjustment

(Setting range: L15 to R15 and Center, Default: Center)

- 1 : Right enhanced
- 2 : Left enhanced



Fader adjustment

(Setting range: R15 to F15 and Center, Default: Center)

- 1 : Front enhanced
- 2 : Rear enhanced



Subwoofer level adjustment

(Setting range : mute (∞), -6 dB to +6 dB, 2 dB Step, Default: 0)

- 1 : Up
- 2 : Down

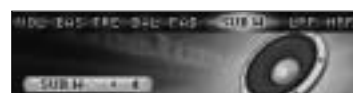

Subwoofer Low Pass Filter

(Setting range: Filter OFF, 60 Hz to 160 Hz, 5 Hz Step, Default 120 Hz)

- 1 : Up
- 2 : Down



Subwoofer output range
Other speakers output ranges

High Pass Filter

(Setting range: Filter OFF, 90 Hz to 225 Hz, 5 Hz Step, Default: Filter OFF)

- 1 : Up
- 2 : Down



You can adjust the settings of bass sound reproduction and 3-dimensional sound field in the CS Auto mode.

Audio Setting (when CS Auto activated)

- 1 Set the CS Auto mode to on. (→ page 16)

- 2 Press [VOLUME] (SEL: SELECT) to display the menu display.



- 3 Press [VOLUME] (SEL: SELECT) to select a mode to be adjusted.

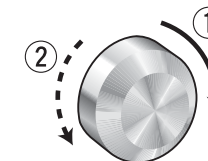

- 4 Turn [VOLUME] clockwise or counterclockwise to adjust.

Note: If no operation takes place for more than 10 sec. in the audio menu (2 sec. in Main volume adjustment), the display returns to the regular mode.

Main volume adjustment

(Setting range: 0 to 40, Default: 18)

- 1 : Up
- 2 : Down



F-TruBass (Front TruBass)

(Setting range: Lv 1 to Lv 10 and OFF, Default: Lv 4)

- 1 : Up
- 2 : Down



R-TruBass (Rear TruBass)

(Setting range: Lv 1 to Lv 10 and OFF, Default: Lv 4)

- 1 : Up
- 2 : Down



S.W-TruBass (Sub Woofer TruBass)

(Setting range: Lv 1 to Lv 10 and OFF, Default: Lv 4)

- 1 : Up
- 2 : Down



F-FOCUS (Front Focus)

(Setting range: Lv 1 to Lv 10 and OFF, Default: Lv 5)

- 1 : Up
- 2 : Down



R-FOCUS (Rear Focus)

(Setting range: Lv 1 to Lv 10 and OFF, Default: Lv 5)

- 1 : Up
- 2 : Down



F-R MIX (Front to Rear Mixing)

(Setting range: Lv 1 to Lv 10 and OFF, Default: Lv 4)

- 1 : Up
- 2 : Down



Notes:

- **TruBass**
TruBass is an audio technology to which the technique of bass sound reproduction used in pipe organs is electrically applied, and in which an equalizer is not used at all and bass sound from the speakers to be used is richly reproduced.
- **FOCUS**
Focus is an audio technology that moves the sound image of playing sound vertically to reproduce the sounds of instruments and voices clearly.

English

Audio Setting

Function Setting

Adjustment to display on the FUNCTION menu

- 1 Press **[MENU]** to display the menu display.

For using the remote control, hold down **[MENU]** for 2 sec. or more.



- 2 Press **[<]** or **[>]** to display the FUNCTION menu.



- 3 Press **[^]** or **[v]** to select a function to be adjusted.

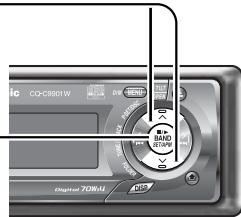

- 4 Press **[BAND]** (**SET**) to adjust.

- 5 Press **[MENU]**.

For using the remote control, hold down **[MENU]** for 2 sec. or more.



MUTE KEY

Setting **[MUTE]** buttons' functions

- MUTE**: Volume off (default)
- ATT LV 1**: Volume down by 10 steps
- ATT LV 2**: Volume down by 5 steps

SECURITY

Setting the security function (→ page 10)

- ON**: ON (default)
- OFF**: OFF

BUILT-IN AMP

You can toggle the integrated amplifier on and off.

- ON**: Amplifier on (default)
- OFF**: Amplifier off (when the external amplifier is used)



Display Setting

Adjustment to display on the DISPLAY menu

- 1 Press **[MENU]** to display the menu display.

For using the remote control, hold down **[MENU]** for 2 sec. or more.



- 2 Press **[<]** or **[>]** to display the DISPLAY menu.

- 3 Press **[^]** or **[v]** to select a function to be adjusted.

- 4 Press **[BAND]** (**SET**) to confirm the display.

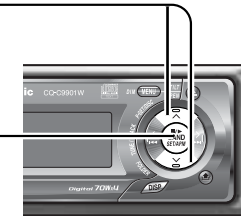

- 5 Adjust the setting value.

- 6 Press **[BAND]** (**SET**) to confirm the adjustment.

- 7 Press **[MENU]**.

For using the remote control, hold down **[MENU]** for 2 sec. or more.



GRAPHIC PATTERN

(Setting range: 5 types (CQ-C9901W)/ 6 types (CQ-C9801W), Default: ALL)

Switching by **[<]** or **[>]**

ALL: Sequential display from pattern A to E.

Pattern A-E

Pattern E: CQ-C9801W only



STILL IMAGE

(Setting range: 11types, Default: ALL)

Switching by **[<]** or **[>]**

ALL: Sequential display from pattern 1 to 10
No.1-10



CONTRAST (CQ-C9801W only)

(Setting range: 1 to 5, Default: Contrast 3)

[>]: Tilting up view angle
[<]: Tilting down view angle



RGB ADJ (CQ-C9901W only)

(Setting range: 1 to 11 each, Default: 1)

You can adjust the screen color.

[>]: Up
[<]: Down
[^][v]: Select



CLOCK ADJ

Note: Adjust the clock when "ADJUST" appears on the display.

[>]: Adjusting minutes
[<]: Adjusting hours
[^]: Forward
[v]: Backward



Note:

- The graphic pattern and still image are changeable. (→ page 36)
- If corrupted data is selected, "DISPLAY FILE INCOMPLETE" appears. (→ page 36)

Customize the Display

You can edit the moving images and still images that are initially stored in the unit. You also can use the data that is downloaded from the Panasonic Web site and the data that is stored with a digital camera or other devices and processed with exclusive software, IMAGE STUDIO. See "Notes on Customize Function" (→ page 37) as well.

Note: Visit Panasonic Web site (<http://panasonic.co.jp/pas/en/software/customize/index.html>) for details.

Preparation:

Put the CD-R/RW that contains data to be customized in hand.

1 If there is a disc inside, take out the disc.

2 Press **[SRC: SOURCE]** to select the CD mode.

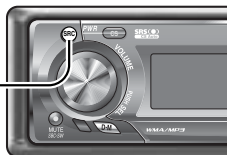

3 Hold down **[SEL]** for 4 sec. or more to display the menu screen.



4 Load a CD-R/RW that contains data.

Note:

- It may take time for the unit to identify the CD-R/RW.
- Discs recorded by the packet writing software are not supported.

5 Select an item to be customized.



[^][V]: Select
[BAND] (SET): Confirm

Note: To exit the customize menu, hold down **[SEL]** 4 sec. or more.

GRAPHIC PATTERN

Moving image data (→ page 35)

STILL IMAGE

Still image data (→ page 35)

OPENING MESSAGE

Moving image at power on (→ page 12)

CLOSING MESSAGE

Moving image at power off (→ page 12)

6 Select a file.

Example: GRAPHIC PATTERN



[^][V][<][>]: Select
[BAND] (SET): Confirm

Notes:

- Files are automatically identified by their extensions, and target files are displayed.
- If **[BACK]** is selected, the screen of step 5 appears.

7 For a moving image file or still image file, select where to save the file.



[<][>]: Select
[BAND] (SET): Confirm

Notes:

- New data overwrites existing data.
- If **[BACK]** is selected, the screen of step 6 appears.

8 Confirm the changed item.



[<][>]: Select
[BAND] (SET): Confirm



Customization is performed. Do not turn off the power in mid-operation. (It takes approx. 8 minutes to complete this operation for a 751 KB moving image.) After completion of this operation, the screen of step 5 appears.

Note: If **[NO]** is selected, the screen of step 5 appears.

9 Press **[OPEN]** to eject the disc.

10 Hold down **[SEL]** for 4 sec. or more. The CD mode comes back.

Note on Download Service

The download service may be suspended or stopped without advance notice. The download service is not available in some areas. Please visit the site below for further information.

Panasonic Web site:
(<http://www.panasonic.co.jp/global/>)

Notes on IMAGE STUDIO

- This download service is not available in some areas. For details, please access the Panasonic website.
- IMAGE STUDIO is available only by downloading from the address below. It is not bundled with this unit.
- Refer to the downloaded operating manual for how to use IMAGE STUDIO.

Notes on File

- The customize-specific file is downloadable from the URL below. You can create exclusive files stored with a digital camera or other devices by using exclusive software, IMAGE STUDIO that can be accessed from the same URL.
- Do not change the extension. Otherwise, the data cannot be recognized.

At Disc Making

- Save only customize-specific data.
- Save all data in the root directory. Files contained in a folder cannot be recognized.
- Follow the table below with regard to the number of files that are saved to a disc. Files beyond the specified capacity are not readable.

Type	Extension	Max. number
GRAPHIC PATTERN	.pfm	10
STILL IMAGE	.pfs	15
OPENING MESSAGE	.pfo	5
CLOSING MESSAGE	.pfe	5

At Customizing

- If customizing is interrupted on account of turning off the power, stopping the engine, removing the face plate or other reasons, you may lose the data. In such a case, try customizing again.
- The default image exists on the Panasonic Web site. If you would like to restore it, download the image from the site.

Download site:

<http://panasonic.co.jp/pas/en/software/customize/index.html>

Error Display Messages

NO FILES DETECTED

No customize-specific data on the disc

→ Load a disc that contains customize-specific data.

CUSTOMIZING FAILED

Customize failed

→ Check to see whether or not the extension is correct and file contents are appropriate.

DISPLAY FILE INCOMPLETE

Intended moving image or still image is damaged.

→ Customize it again and overwrite the file with new one.

If You Suspect Something Wrong

Check and take steps as described below.

If the described suggestions do not solve the problem, it is recommended to take the unit to your nearest authorized Panasonic Service center. The product should be serviced only by qualified personnel. Please refer the checking and the repair to professionals. Panasonic shall not be liable for any accidents arising out of neglect of checking the unit or your own repair after your checking.

⚠ Warning

- Do not use the unit in an irregular condition, for example, without sound, or with smoke or foul smell, which can cause ignition or electric shock. Immediately stop using the unit and consult your dealer.
- Never try to repair the unit by yourself because it is dangerous to do so.

Common

Problem	Possible cause → Possible solution
No power to the unit	The power cord (battery, power and ground) is connected in the wrong way. → Check the wiring.
	Fuse blowout → Eliminate the cause of fuse blowout and replace the fuse with new one. Consult your dealer.
Sound is not generated.	MUTE is set to ON. → Set MUTE to OFF.
	The wiring of speaker lines are not correct, or a break or poor contact arises. → Check the wiring in accordance with the wiring diagram. (Installation Instructions)
	BUILT-IN AMP is set to ON. → Set BUILT-IN AMP to OFF. Observe that "AMP OFF" is displayed on the screen.
The demonstration screen displayed and no operable	You cannot operate the unit while the demonstration screen appears. → Press [DISP] to end the demonstration screen.
	If the demonstration screen appears frequently, there is a possibility that poor contact or wrong wiring arises between the battery lead of the unit and the battery cable of the car. (The battery lead should be always powered.) → Check the battery wiring in accordance with the wiring diagram.
Noise	There is an electromagnetic-wave generator such as a cellular phone near the unit or its electrical lines. → Keep an electromagnetic-wave generator such as a cellular phone away from the unit and the wiring of the unit. In case that noise cannot be eliminated due to the wiring harness of the car, consult your dealer.
	The contact of the ground lead is poor. → Make sure that the ground lead is connected to an unpainted part of the chassis securely.
Noise is made in step with engine revolutions.	Alternator noise comes from the car. → Change the wiring position of the ground lead. → Mount a noise filter on the power supply.

Common (continued)

Problem	Possible cause → Possible solution
Some operations are not executable.	Some operations are not executable in particular modes such as menu mode. → Read the operating instructions carefully and cancel the mode. If the unit is still out of order, consult your dealer.
No sound from speaker (s)	Balance/Fader setting is not appropriate. → Readjust Balance/Fader.
	There is a break, a short circuit, poor contact or wrong wiring regarding the speaker wiring. → Check the speaker wiring.
The speaker channels are reversed between right and left.	The speaker wiring is reversed between right and left. → Perform the speaker wiring in accordance with the wiring diagram.
The sound field is not clear in the stereo mode. Central sound is not settled.	The plus and minus terminals at right and left channels of speakers are connected reversely. → Perform the speaker wiring in accordance with the wiring diagram.
The power of the unit fails unintentionally.	The safety device works. → Consult your dealer, or your nearest Panasonic Service center.
Playing sound is interrupted	An inappropriate speaker network (device) is used. → Use a speaker without any speaker network, or use an appropriate speaker network system that does not cause interruption.
Disc unejectable	Something such as a peeled label obstructs the disc coming out. → Press and hold the [OPEN] for more than 2 seconds when the face plate is open (disc forced ejection). In case that the disc forced ejection does not work, consult your dealer.
	The microcontroller in the unit operates abnormally due to noise or other factors. → Unplug the power cord and plug it again. In case the unit is still out of order, consult your dealer.

English

Troubleshooting

Problem	Possible cause → Possible solution
Poor reception or noise	<p>Antenna installation or wiring of antenna cable is faulty. → Check whether the antenna mounting position and its wiring are correct. In addition, check to see whether the antenna ground is securely connected to the chassis.</p> <p>No power is supplied to the antenna amplifier (when using a film antenna, etc.). → Check the wiring of the antenna battery lead.</p>
FM Stereo broadcast is received only in mono.	<p>The MONO mode is active. → Cancel the MONO mode.</p>
Only nearby stations can be received.	<p>The LOCAL mode is active. → Cancel the LOCAL mode.</p>
The number of auto preset stations is less than 6.	<p>The number of receivable stations is less than 6. → Move to an area where receivable stations number is maximum, and try pre-setting.</p>
Preset stations cannot be stored.	<p>The contact of the battery lead is poor, or the battery lead is not always powered. → Make sure that the battery lead is connected securely, and preset stations again.</p>

Problem	Possible cause → Possible solution
No playback or disc ejected	<p>The disc is inserted upside down. → Insert a disc correctly.</p> <p>There is a flaw or foreign material on the disc. → Remove the foreign material, or use a flawless disc.</p>
Sound skipping or noise	<p>There is a flaw or foreign material on the disc. → Remove the foreign material, or use a flawless disc.</p>
Sound skipping due to vibration	<p>The unit is not sufficiently secured. → Secure the unit to the console box.</p> <p>The unit is tilted at over 30° in the front-to-end direction. → Make the angle 30° or less.</p>

The CD-R/RWs that are playable on other devices are not playable on this unit.	<p>The playability of some CD-R/RWs may depend on the combination of media, recording software and recorder to be used even if these CD-R/RWs are playable on other devices such as a PC. → Make CD-R/RWs in different combination of media, recording software and recorder after referring to the description about MP3/WMA.</p>
Sound skipping or noise	<p>There is a flaw or foreign material on the disc. → Remove the foreign objects, or use a flawless disc. For MP3/WMA, refer to the description about MP3/WMA.</p> <p>Playing VBR (Variable Bit Rate) files may cause sound skipping. → Play Non-VBR files.</p>

Note: Refer to "Notes on MP3/WMA". (⇒ Page 26)

No response to pressing buttons	<p>The battery is inserted in the wrong direction. A wrong battery is inserted. → Insert a correct battery in the correct direction.</p>
	<p>The battery is weak. → Replace the battery with new one.</p>
	<p>The aiming direction of the remote control unit is wrong. → Aim the remote control unit at the sensor of the unit and press buttons.</p>
	<p>The sensor is exposed to direct sunlight. (The remote control unit may not be operable when the sensor is exposed to direct sunlight. In such a case, the system is not faulty.) → Block off sunlight to the sensor.</p>

Display	Possible cause → Possible solution
CD E1	The disc is dirty or upside down. → Check the disc.
CD E2	The disc has scratches. → Check the disc.
CD E3	No operation by some cause. → Unplug the power cord and plug it again. In case the unit is still out of order, consult your dealer.
CD E4	The player for some reason cannot read the file you are trying to play. (File recorded in an unsupported file system, compression scheme, data format, file name extension, damaged data, etc.) → Select a file that the player can read. Check the type of data recorded on the disc. Create a new disc if necessary.
PROTECTED (After 5 seconds) To next file automatically	A WMA file can be copyrighted. → The file protected by copyright is not playable.
NO DISC	No disc.

CHANGER E1	Disc is dirty, or is upside down.
CHANGER E2 (After 5 seconds) To next disc automatically	Disc has scratches. → Eject the magazine. • Check the disc. • Load the disc again.
CHANGER E3	No operation by some cause. → Eject the magazine. If failure persists, press the reset switch on the CD changer. If normal operation is not restored, call the store where you purchased the unit or the nearest Panasonic Service Center to ask for repairs.
CHANGER E6	An error arises in the DVD changer. → Check the DVD changer. ("REGION ERROR" etc.)
NO DISC	No disc (magazine). → Insert discs into the changer (magazine)
NOT CONNECTED	No changer. → Verify the wiring.

Note: Messages in the action and display sections of the error chart vary with changers. Refer to the operating instructions for the CD changer for details.

If you use commercial CDs, they must have either of these labels shown at right. Some copy-protected music CDs are not playable.



How to hold the disc

- Do not touch the underside of a disc.
- Do not scratch on a disc.
- Do not bend a disc.
- When not in use, keep a disc in the case.

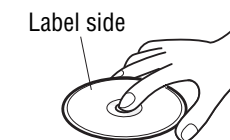

Do not use irregularly shaped discs.

Do not leave discs in the following places:

- In direct sunlight
- Near car heaters
- Dirty, dusty and damp areas
- On seats and dashboards



Do not use irregularly shaped discs.

Disc cleaning

Use a dry, soft cloth to wipe from the centre outward.

Do not attach any seals or labels to your discs.

Do not write on the disc label with a ballpoint pen or other hard-point pens.



- You may have trouble playing back some CD-R/RW discs recorded on CD recorders (CD-R/RW drives), either due to their recording characteristics or dirt, fingerprints, scratches, etc. on the disc surface.
- CD-R/RW discs are less resistant to high temperatures and high humidity than ordinary music CDs. Leaving them inside a car for extended periods may damage and make playback impossible.
- Some CD-R/RWs can not be played back successfully due to incompatibility among writing software, a CD recorder (CD-R/RW drive) and the discs.
- This player cannot play the CD-R/RW discs if the session is not closed.
- This player cannot play the CD-R/RW discs which contains other than CD-DA or MP3/WMA data.
- Be sure to observe the instructions of CD-R/RW disc for handling it.

Maintenance

Cleaning the Unit

This unit is designed and manufactured to ensure the minimum of maintenance. Use a dry, soft cloth for routine exterior cleaning. Never use benzine, thinner, or other solvents.

Fuse

If the fuse blows out, consult your dealer, or your nearest authorized Panasonic Service Center.

Warning

Use fuses of the same specified rating (**15 A**). Using substitutes or fuses with higher ratings, or connecting the unit directly without a fuse could cause fire or damage to the unit. **If the replaced fuse fails, contact your nearest authorized Panasonic Service center.**

Contents by Functions

Contents by Functions

Clock adjustment (CLOCK ADJ: CLOCK ADJUSTMENT)	11
Temporary Volume off (Down) (MUTE (ATT : ATTENUATION))	13
Display Change (DISP : DISPLAY)	15
Dimmer Control (DIM : DIMMER)	15
SBC-SW: SUPER BASS CONTROL-SUBWOOFER	16
Direct Memory (D · M : DIRECT MEMORY)	20

Specifications

General

Power Supply	DC 12 V (11 V – 16 V), Test Voltage 14.4 V, Negative Ground
Tone Controls (Bass/Treble)	Bass; ±12 dB at 80 Hz, Treble; ±12 dB at 6 kHz
Equalizer Center Frequency (SQ)	62.5, 125, 250, 500, 1 k, 2 k, 4 k, 8 k, 16 k (Hz, default)
Variable Range of Equalizer	–12 dB to 12 dB (2 dB step)
Current Consumption	Less than 2.5 A (CD mode, 0.5 W 4-Speaker)
Maximum Power Output	70 W x 4 (at 4 Ω)
Power Output	33 W x 4 (at 4 Ω)
Speaker Impedance	4 to 8 Ω
Pre-amp output voltage	5 V (CD mode)
Subwoofer-output voltage	5 V
Pre-amp output impedance	60 Ω
Subwoofer impedance	60 Ω
External Input Impedance	10 kΩ (AUX1, CH/AUX2 IN)
External Input Sensitivity	Max. 2 V (AUX1, CH/AUX2 IN)
Dimensions (Main Unit)	178 (W) x 50 (H) x 155 (D) mm
Weight (Main Unit)	1.7 kg

CD Player

Sampling Frequency	8 times oversampling
Pick-Up Type	Astigma 3-beam
Light Source	Semiconductor laser
Wavelength	790 nm
Frequency Response	20 Hz – 20 kHz (±1 dB)
Signal to Noise Ratio	96 dB (2 V), 106 dB (5 V)
Total Harmonic Distortion	0.01 % (1 kHz)
Wow and Flutter	Below measurable limits
Channel Separation	86 dB (2 V)

Stereo Radio

FM	
Frequency Range	87.5 MHz – 108.0 MHz
Usable Sensitivity	8 dB/μV (S/N 30 dB)
Stereo Separation	40 dB (1 kHz)
AM	
Frequency Range	531 kHz – 1 602 kHz
Usable Sensitivity	25 dB/μV (S/N 20 dB)

Notes:

- Specifications and design are subject to modification without notice due to improvements.
- Some figures and illustrations in this manual may be different from your product.