

OWNER'S MANUAL

LS4000W, LS4000B, LS4000S LS4001W, LS4001B, LS4001S

AM/FM Stereo Receiver and Compact Disc Player

Designed for In-Wall Installation of All Recreational Vehicles, Motor Homes and Mobile Housings

12 Volts DC

U.S. Patent No. D502, 461

***LINEAR
SERIES***[®]

A Registered Trademark of Magnadyne Corporation

INTRODUCTION

Please read all of the information in this booklet before using this unit to insure that you fully understand the capabilities of this unit.

WARNING! To prevent fire or electrical shock hazard, do not expose this product to rain or moisture, or remove cover or bottom screws. No user serviceable parts inside. Refer servicing to qualified service personnel.

CONTROLS AND FUNCTIONS

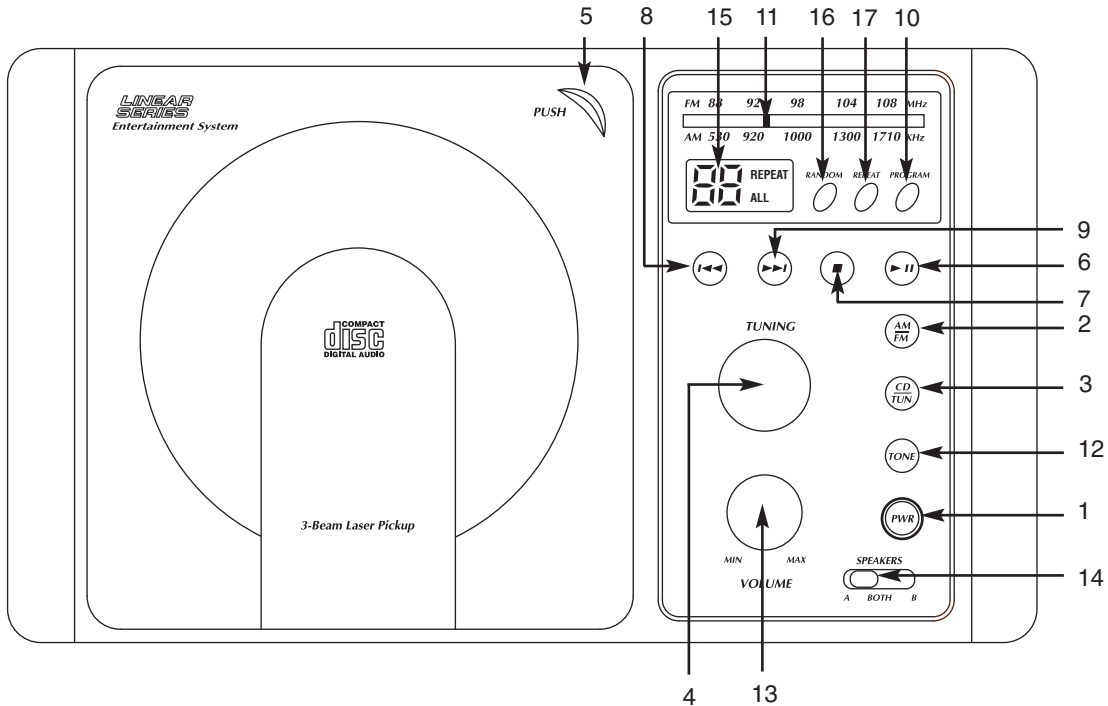

CONTROLS AND FUNCTIONS

1. Power Button (PWR)

Press this button in to turn the unit on. Press again to turn the unit off.

2. AM/FM Button

Press the button to select the desired AM or FM radio band.

3. CD/Tuner Button

Press this button to select the desired playing mode either AM/FM radio or CD player.

4. Radio Station Tuning Knob

Rotate this knob to locate the radio station that you desire. Rotating it clockwise will take you up the frequency band and rotating it counter-clockwise will take you down the frequency band.

5. Compact Disc Door

By pressing the compact disc door next to the word "PUSH" the door will open to allow you to insert a compact disc.

6. Play/Pause Button (▶ ||)

After inserting a compact disc press this button to begin compact disc play. Pressing this button again will stop the compact disc until the button is pressed again.

7. Stop Button (■)

When this button is pressed, compact disc play will stop.

8. Skip Down Button (◀◀)

To skip to the next lower track on the compact disc, press this button.

9. Skip Up Button (▶▶)

To skip to the next higher track on the compact disc, press this button.

10. Program Button

Use the program button to arrange the tracks on the disc to play in the order you wish. (See compact disc operation)

11. Dial Indicator

The dial indicator will move up and down the scale as you rotate the tuning knob (4) indicating the station you are listening to.

12. Tone Button

This button will tailor the overall tone of the unit. Pushing the button in will achieve lower tones and pushing the button again will achieve higher tones.

13. Volume Control Knob

Rotate this knob clockwise to increase the volume of the unit.

14. Speaker A, B and A+B Selector

To play the "A" set of speakers, slide the selector to the "Speaker A" position. To play the "B" set of speakers, slide the selector to the "Speaker B" position. To play the "A" and "B" speakers at the same time, slide the selector to the center position.

15. Compact Disc Display

This display contains all the information about the disc that is playing and all the modes the disc can play under. (See compact disc operation).

CONTROLS AND FUNCTIONS

16. Random Button

Use the random button to play the disc tracks in a random order selected by the disc player's computer.

17. Repeat Button

Use the repeat button to continuously play one song repeatedly or to continuously play the entire disc repeatedly.

Radio Operation:

1. Press the PWR button (1) in to turn the unit on.
2. Press the CD/TUN button (3) to select radio operation.

This Area Lights
Up for CD
Operation

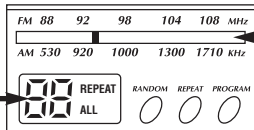

This Area Lights
Up for Radio
Operation

3. Press the AM/FM button (2) to select either the AM or FM radio band.
4. Tune in the desired radio station by rotating the tuning knob (4).
5. Adjust the VOLUME (13) and TONE (12) as desired.

FM Stereo Operation:

The unit will automatically switch from FM mono to FM stereo when the signal strength increases to a stereo level. If the signal should become weak on stereo reception, the unit will switch back to the mono mode.

Compact Disc Operation:

1. Press the PWR button (1) in to turn the unit on.
2. Press the CD/TUN button (3) to select CD operation.
3. Press the door (5) and gently pull the compact disc door open fully.
4. Insert a disc onto the disc hub and press gently in the center until the disc is secure and supported by the hub.
5. Close the compact disc door until it snaps into place. Allow 10 seconds for the system to read the disc.
6. Use the skip down button \blacktriangleleft (8) or skip up button \blacktriangleright (9) to select a specific track.
7. Press the play button $\blacktriangleright \parallel$ (6) and adjust the volume and tone controls as desired.
8. Press the stop button \blacksquare (6) to stop disc play.

Warning ! Never touch the laser eye. Moisture and oils from your fingers can impair proper operation.

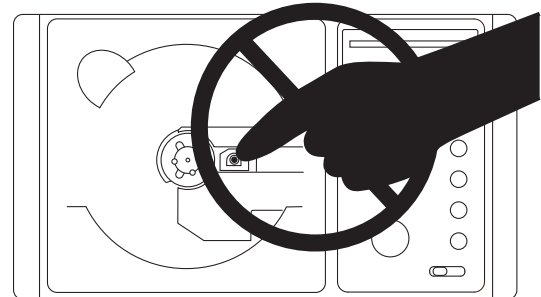

CONTROLS AND FUNCTIONS

Using the Compact Disc Program Feature:

If you desire to have the song selection of the disc played in a different order than arranged on the disc, repeat the following procedures to program the playing order.

1. When the CD disc is stopped, press the PROGRAM button (10). The PGM indicator will be displayed (15).

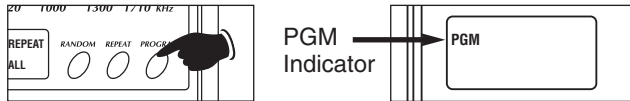

2. Use the skip down button $\blacktriangleleft\blacktriangleleft$ (8) or skip up button $\blacktriangleright\blacktriangleright$ (9) to select a specific track. Press the program button to lock in the selection.
3. Repeat step #2 to program the the listening order of the tracks on the disc, you can program up to a maximum of 21 tracks.
4. After all the tracks required are programmed, press the PROGRAM button (10) once again to lock the program. The compact display will then display the play order you programmed.
5. Press the play button $\blacktriangleright\parallel$ (6) to play the new program.

Note 1: Pressing the Stop button (7) will stop the play function but will not erase the program sequence. Press the PROGRAM (10) button, then the Play button (6) once again this will start the play/program function from the first programmed track.

Note 2: Opening the CD door, changing the source selection to AM/FM or shutting the power OFF on the unit will clear the program memory.

Using the Compact Disc Random Feature:

The random feature allows the disc player to select and play the songs on the disc in random play order.

1. To initiate the random feature, insert a disc and close the CD door. Press the RANDOM button (16) before pressing the play button (6). Press Play (6) and the disc will play.

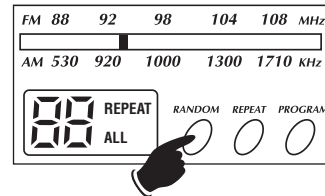

2. To turn off the random function press the RANDOM button (16) once again.

Note: You can activate and deactivate the random feature at any time by pressing the RANDOM button (16).

CONTROLS AND FUNCTIONS

Using the Repeat Feature:

The repeat feature has two modes of operation. A single track can be continuously repeated or the entire disc can be continuously repeated.

Repeating Single CD Track:

Press the REPEAT button (17) one time while a CD is playing. "REP" will be flashing in the compact disc display (15) area. The song will repeat continuously.

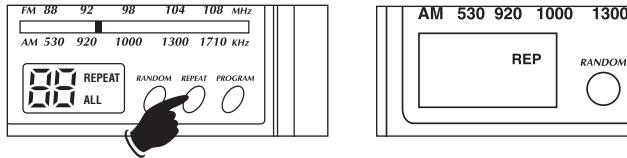

Repeating Entire CD:

Press the REPEAT button (17) two times while a track is playing. "REP" will be indicated on the compact disc display (15) area. The disc will play all the way through to the last song and then repeat to the first song continuously.

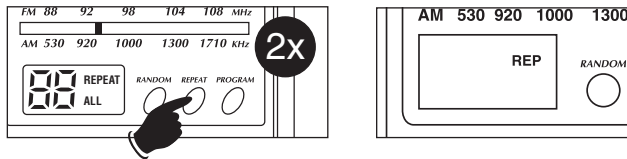

Cancelling Repeat Feature:

To turn off the repeat feature, press the repeat button (17) a third time (the REP1 or REP indicator will be off in the display).

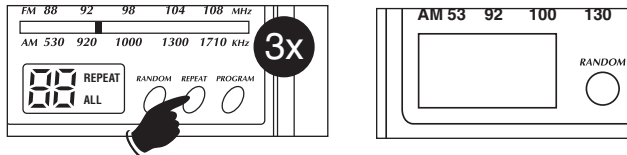

Handling the Disc:

1. When inserting the disc, hold the disc with your thumb, middle finger and index finger and press the center with your index finger.
2. When removing the disc, always pull at the left or right edge of the disc until it snaps loose from the disc hub. There are indentations in the plastic for your fingers at these points.
3. Always keep your discs clean and free from scratches, fingerprints and dirt.

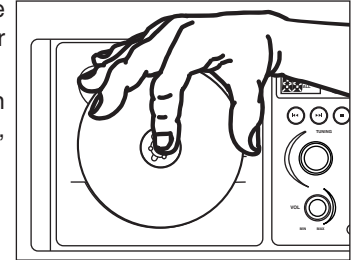

INSTALLATION

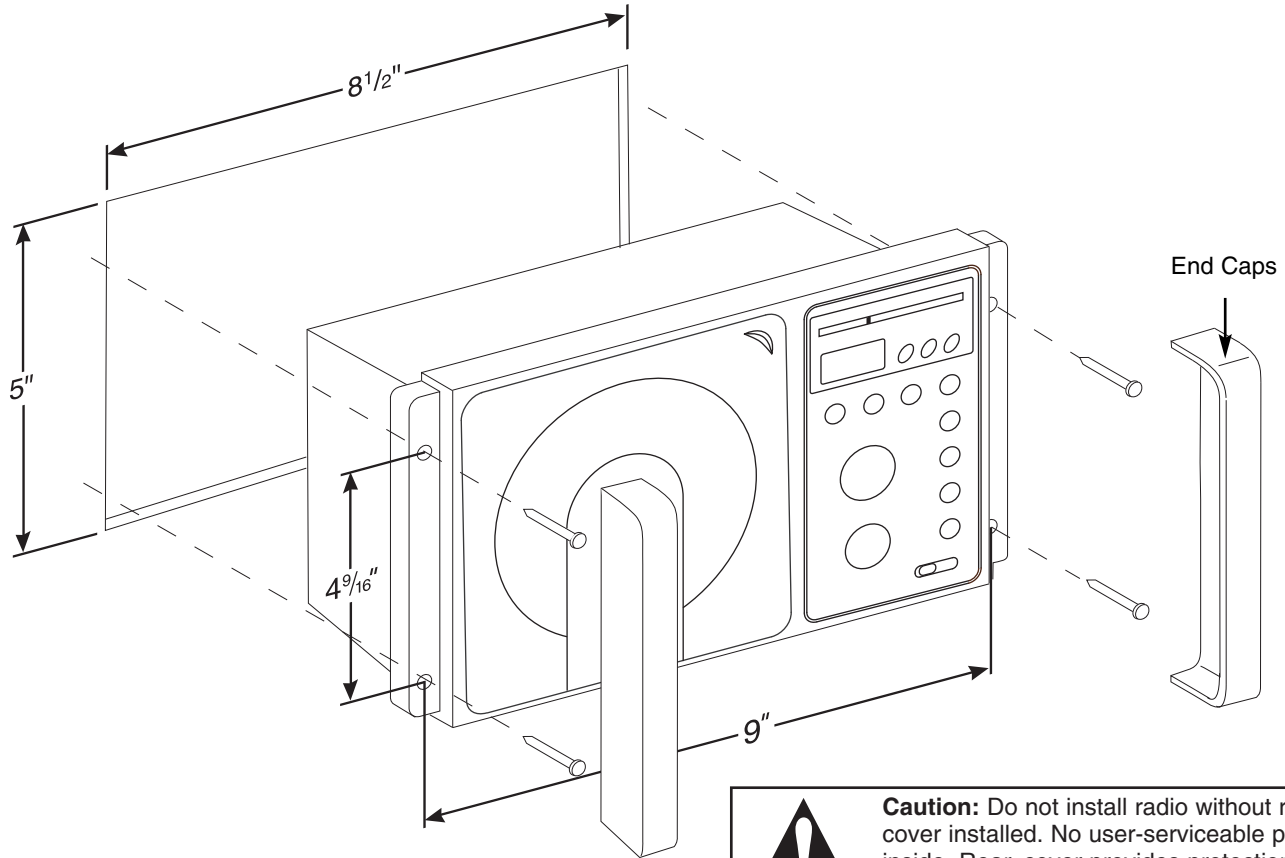

POWER CONNECTIONS

This unit for use only with a 12 volt DC power source with a negative ground.

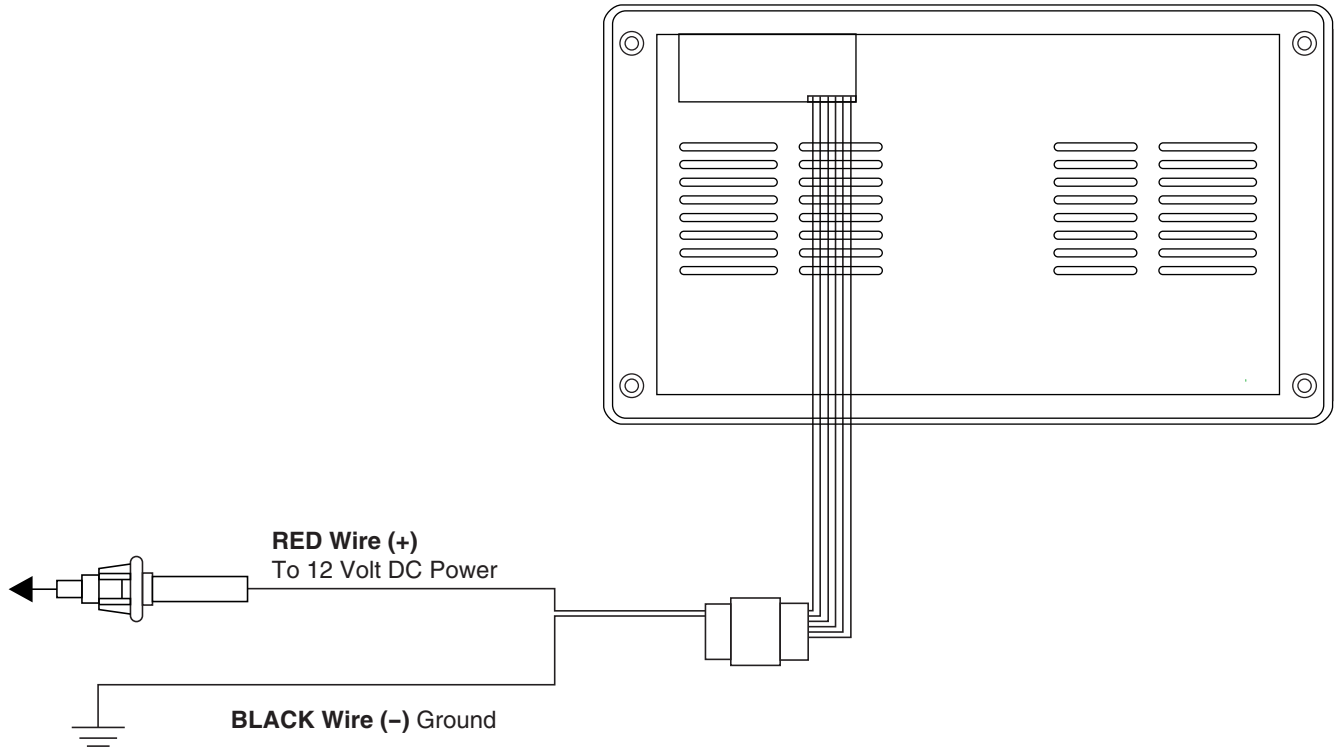

SPEAKER CONNECTIONS

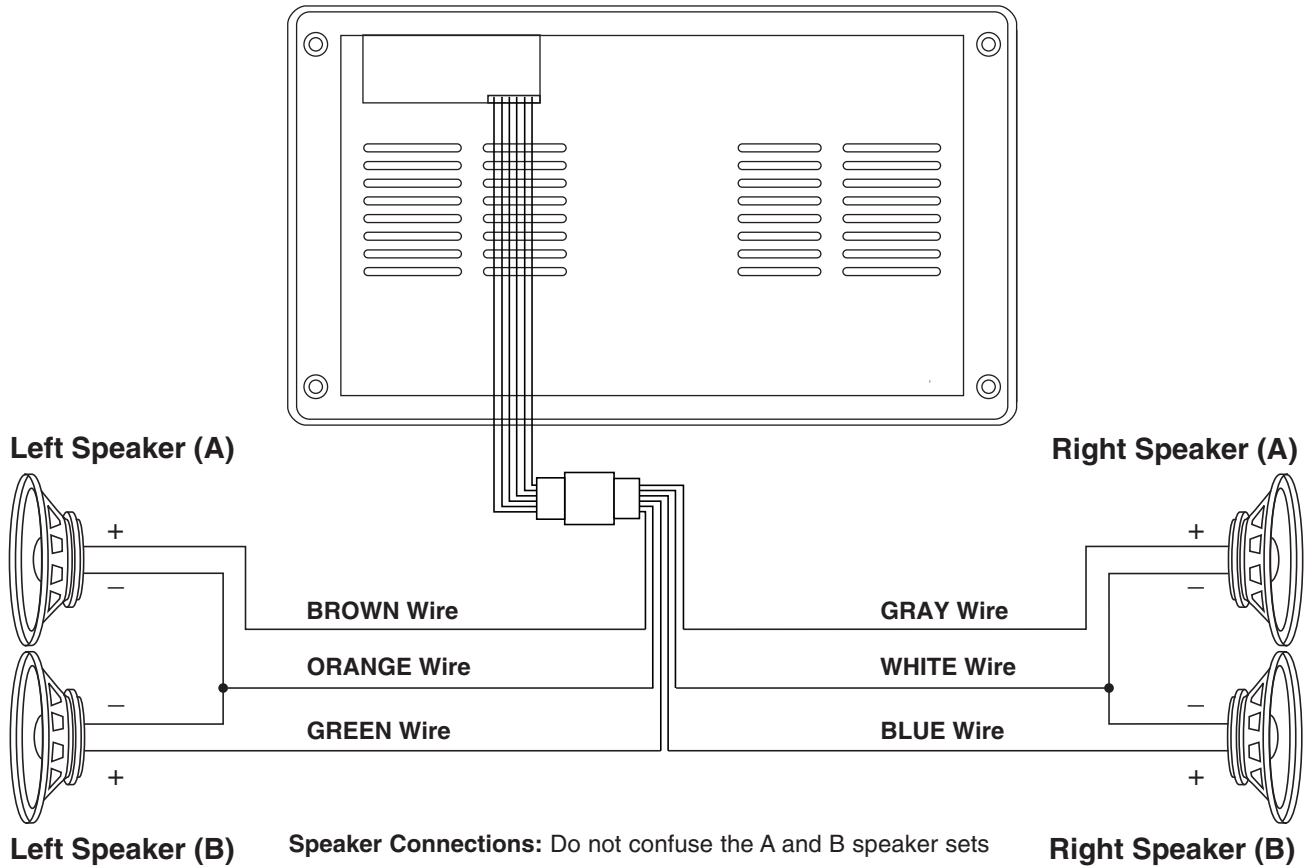

ANTENNA CONNECTIONS

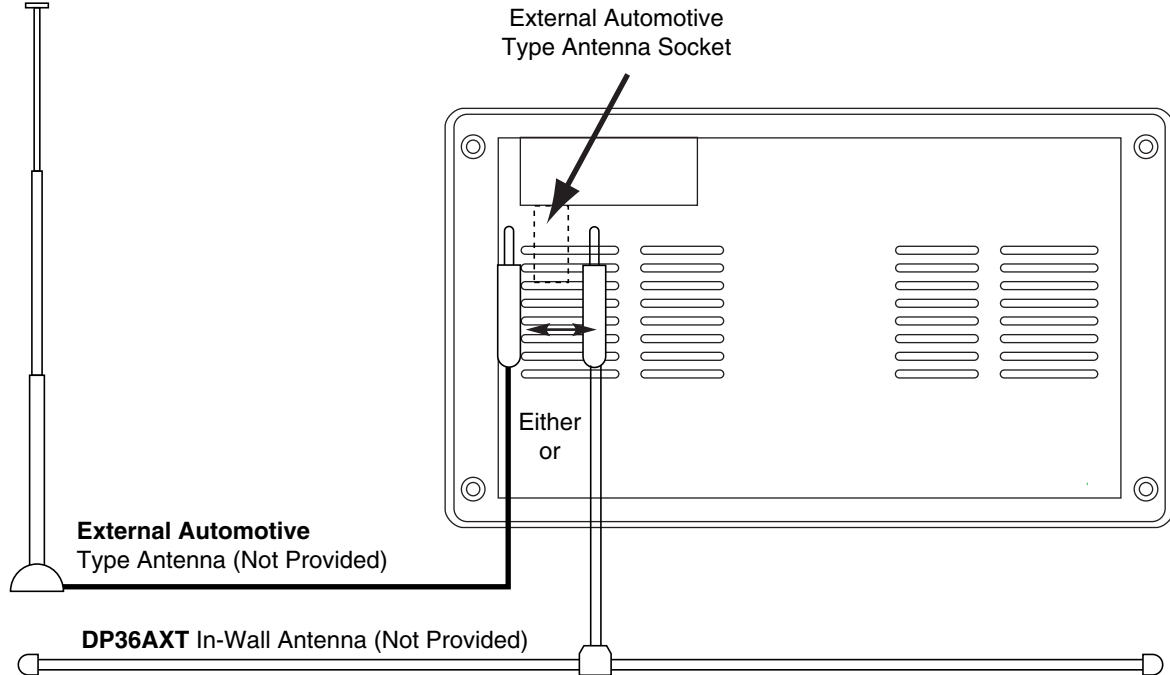

The LS4000 and LS4001 have a provision for a standard automotive antenna. If an automotive antenna is used, plug the male plug from the antenna into the female receptacle provided on the unit.

If an automotive antenna is not available or is undesired, we recommend the use of a Magnadyne DP36AXT di-pole antenna substitute. Plug the male plug from the DP36AXT into the female receptacle of the LS4000 or LS4001 unit and allow the cable of the antenna to lay inside the wall.

SAFETY INSTRUCTIONS

Read Instructions: All the safety and operating instructions should be read before the appliance is operated.

Retain Instructions: The safety and operating instructions should be retained for future reference.

Heed Warnings: All warnings on the appliance and in the operating instructions should be adhered to.

Follow Instructions: All operating and use instructions should be followed.

Water and Moisture: The appliance should not be used near water- for example, near a bathtub, washbowl, kitchen sink, laundry tub, in a wet basement, or near a swimming pool, etc.

Wall or Ceiling Mounting: The appliance should be mounted to a wall or ceiling only recommended by the manufacturer.

Heat: The appliance should be situated away from heat sources such as radiators, heat registers, stoves, or other appliances (including amplifiers) that produce heat.

Power Supply: The appliance should be connected to a power supply only of the type described in the operating instructions or as marked on the appliance.

Cleaning: The appliance should be cleaned only as recommended by the manufacturer.

Power Lines: An outdoor antenna should be located away from power lines.

Outdoor Antenna Grounding: If an outside antenna is connected to the receiver, be sure the antenna system is grounded so as to provide some protection against voltage surges and built up static charges. Section 810 of the National Electrical Code, ANSI/NFPA no. 70-1983, provides information with respect to proper grounding of the mast and supporting structure, grounding of the lead-in wire to an antenna discharge unit, size of grounding conductors, location of antenna-discharge unit, connection to grounding electrodes, and requirements for the grounding electrode. See figure 1.

Object and Liquid Entry: Care should be taken so that objects do not fall and liquids are not spilled into the enclosure through openings.

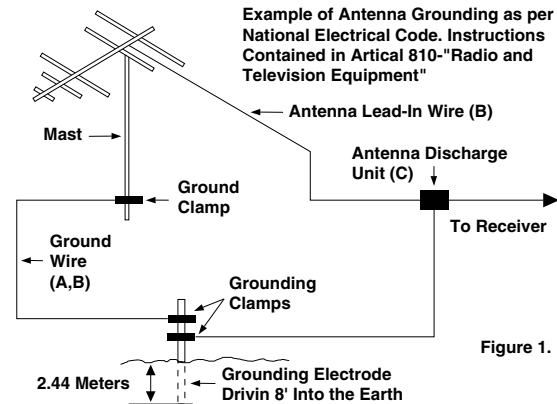

- A) Use No. 10 AWG (5.3mm²) copper, No 8 AWG (8.4mm²) aluminum, No. 17 AWG (1.0mm²) copper clad steel or bronze wire, or larger, as ground wire.
- B) Secure antenna lead-in and ground wires to house with stand-off insulators spaced from 4 feet (1.22m) to 6 feet (1.83m) apart.
- C) Mount antenna discharge unit as close as possible to where lead-in enters house.

OPERATION AND MAINTENANCE

Damage Requiring Service: The appliance should be serviced by qualified service personnel when:

- A. The power supply cord or the plug has been damaged; or
- B. Objects have fallen, or liquid has spilled into the appliance; or
- C. The appliance has been exposed to rain; or
- D. The appliance does not appear to operate normally or exhibits a marked change in performance; or
- E. The appliance has been dropped, or the enclosure damaged.

Servicing:

The user should not attempt to service the appliance beyond that described in the operating instructions. All other servicing should be referred to qualified service personnel.

Caution:

Compact disc should be stored in a container or vinyl bag to prevent contamination. Disc should not be placed in locations exposed to sunlight or heat.

Warnings



Handle CD's Properly



Do Not Touch CD's



Do Not Get Dirt on CD's



Do Not Write on CD's



Do Not Scratch CD's

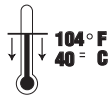

Keep Below 104° Fahrenheit



Do Not Bend CD's

WARRANTY

ONE (1) YEAR LIMITED WARRANTY

Magnadyne Corporation or its authorized agents will within 1 year from the date of sale to you, repair, replace or refund the retail sales price of said product or any part thereof, at the option of the Magnadyne Corporation or its authorized agents, if said product or part is found defective in materials or workmanship, when properly connected and operating on the correct power requirements designated for the specific product. This warranty and Magnadyne Corporation or its authorized agents obligations hereunder do not apply where the product was; damaged while in the possession of the consumer, subjected to unreasonable or unintended use, not reasonably maintained, utilized in commercial or industrial operations, or serviced by anyone other than Magnadyne Corporation or its authorized agents, or where the warning seal on the product is broken or the power and/or plugs are detached from the unit. Magnadyne Corporation or any of its authorized agents will not assume any labor costs for the removal and re-installation of any product found to be defective, or the cost of transportation to Magnadyne Corporation or its authorized agents. Such costs are the sole responsibility of the purchaser.

This warranty does not cover the cabinet appearance items or accessories used in connection with this product, or any damaged to recording or recording tape, or any damage to the to the products resulting from improper installation, alteration, accident, misuse, abuse or acts of nature. MAGNADYNE CORPORATION OR ITS AUTHORIZED AGENTS SHALL NOT BE LIABLE TO ANYONE FOR CONSEQUENTIAL OR INCIDENTAL DAMAGES OR CLAIMS EXCEPT THOSE ACCORDED BY LAW. NO EXPRESSED WARRANTY OR IMPLIED WARRANTY IS GIVEN EXCEPT THOSE SET FORTH HEREIN. NO IMPLIED WARRANTY SHALL EXTEND BEYOND 1 YEAR FROM THE DATE OF SALE.

This warranty extends only to the original purchaser of the product and is not transferable.

Some states do not allow limitations on how long an implied warranty lasts, and some states do not allow the exclusion or limitation of incidental or consequential damages, so the above limitations or exclusion may not apply to you. This warranty gives you specific legal rights, and you may have other rights that vary from state to state.

Defective merchandise should be returned to the original point of purchase or secondly, to Magnadyne Corporation, 1111 W. Victoria Street, Compton CA 90220. A Return Authorization must be obtained before sending any product, or merchandise may be refused.