

Installation and Operations Manual

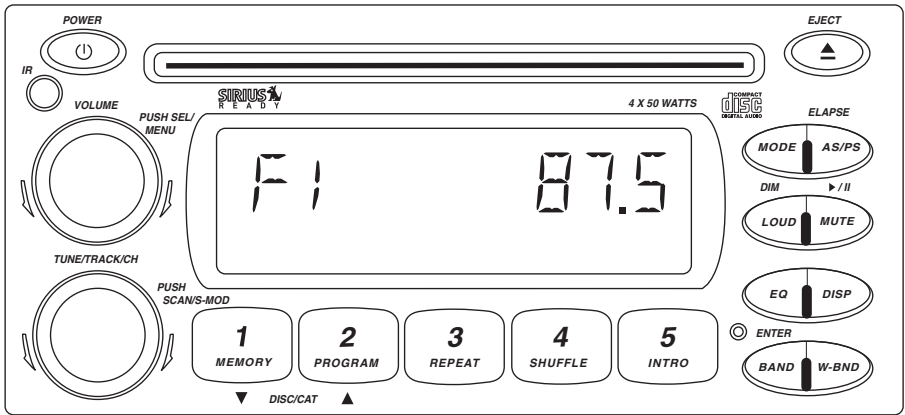

M9900CDS AM / FM / WB and CD Stereo Receiver



Introduction

Your new Sirius ready in-dash entertainment system has been designed for many years of listening pleasure. Take a moment to read through this manual and become familiar with the operations and features of this outstanding product.

It is advisable to keep this manual in your vehicle ready for reference. We hope the experience with your new mobile entertainment system is a pleasurable one. Be sure to fill out and send in your warranty card. In the unlikely event that your system will need service during the warranty period, you will need to be registered to receive the full benefits of warranty repair.

Button Locations and Functions

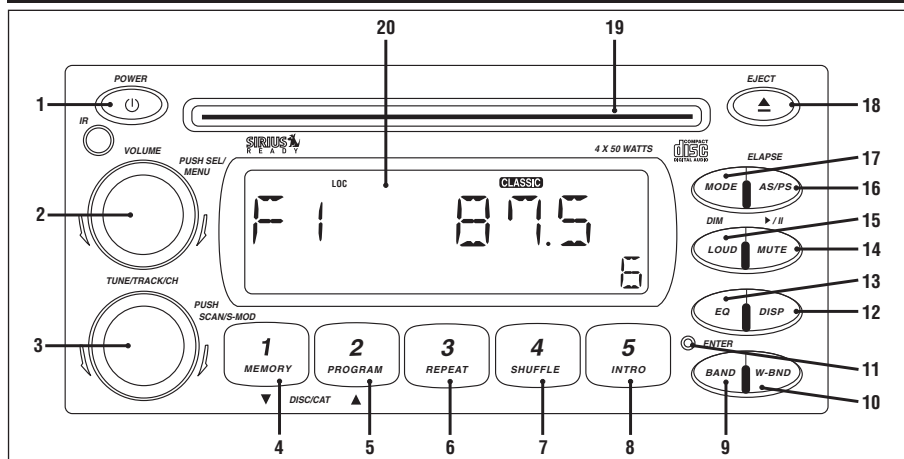

1. Power On/Off: Push to turn the unit on or off.

2. Volume/Sound Controls: Rotate to increase or decrease the volume level. Push to scan between the different sound controls (Volume, Bass, Treble, Balance and Fader).

3. Multi-Function Knob:

Radio Mode:

Manual Tuning: Rotate the TUNE knob to the left or right and hold until "Manual" appears in the display then release knob. Rotate the TUNE knob again left or right until the desired radio station appears in the display.

Scan Tuning: Push and release the TUNE knob. The tuner will scan up, pausing for 5 seconds at each strong station. Push and release the TUNE knob again to cancel the scan function.

Seek Tuning: Rotate the TUNE knob to the left or right and release. The tuner will scan to the next strong station and stop.

CD and CD Changer Mode: Rotate the TUNE knob to the left or right to change the CD track on the CD that is playing.

Sirius Satellite Radio Mode: Push to access Manual Tuning, Category Tuning and Direct Tuning in Sirius mode. (See Sirius Radio Operation for more information, page 8)

4. Multi-Function Button #1:

Radio Mode: Push and hold until a beep is heard to memorize a radio station into memory #1 (CH1). Push and release when recalling preset radio station #1.

CD Mode: Push to enter CD track memory mode (see CD Operation for more information, page 6-7).

CD Changer Mode: Push to change to a lower number disc in the CD changer.

Sirius Satellite Radio Mode: Push to scroll through the Sirius Radio playback categories.

Button Locations and Functions

5. Multi-Function Button #2:

Radio Mode: Push and hold until a beep is heard to memorize a radio station into memory #2 (CH2). Push and release when recalling preset radio station #2.

CD Mode: Push to play programmed CD tracks (see CD Operation for more information, page 6-7).

CD Changer Mode: Push to change to a higher number disc in the CD changer.

Sirius Satellite Radio Mode: Push to scroll through the Sirius Radio playback categories.

6. Multi-Function Button #3:

Radio Mode: Push and hold until a beep is heard to memorize a radio station into memory #3 (CH3). Push and release when recalling preset radio station #3.

CD Mode: Push to repeat a CD track. Push again to cancel.

CD Changer Mode: Push to repeat a CD track. Push again to cancel.

Push and hold to repeat the entire disc. Push again to cancel.

7. Multi-Function Button #4:

Radio Mode: Push and hold until a beep is heard to memorize a radio station into memory #4 (CH4). Push and release when recalling preset radio station #4.

CD Mode: Push to play all the tracks on the CD in random order. Push again to cancel.

CD Changer Mode: Push to play all the tracks on the CD in random order. Push again to cancel.

Push and hold to play all the CDs in random order. Push again to cancel.

8. Multi-Function Button #5:

Radio Mode: Push and hold until a beep is heard to memorize a radio station into memory #5 (CH5). Push and release when recalling preset radio station #5.

CD Mode: Push to preview each track on the CD for 10 seconds. Push again to cancel.

CD Changer Mode: Push to preview each track on the CD for 10 seconds. Push again to cancel.

Push and hold to preview each track on every CD for 10 seconds. Push again to cancel.

9. Band Button: Push to select F1, F2, F3, AM1, AM2 or W (weather band).

10. Weather Band Radio Button: Push to instantly access the weather band radio. Push mode to return to previous source.

11. Reset Button: Push to reset the unit to its "DEFAULT" settings.

12. Display Button: Push to display the frequency in radio mode or track in CD mode. Push and hold to perform clock setting functions (See Clock Setting for more information, page 6)

13. Equalizer Button: Push to choose between preset sound equalization settings.

14. Mute Button (CD Play/Pause) Button:

Radio and Sirius Satellite Radio Mode: Push to mute volume level. Push again to restore volume.

CD and CD Changer Mode: Push to pause disc play, push again to resume play.

15. Loud (Dim Button): Push and release to boost high and low tones at low volume levels. Push and hold to dim or restore backlight of display.

16. AS/PS (CD Elapse Button):

Radio Mode: Push for automatic memory storing and preset scan.

CD and CD Changer Mode: Push to display running time/remain time of a CD track.

17. Mode Button: Push to change the play source: Radio, Sirius Satellite Radio, CD, CD Changer or Auxiliary Sources.

18. Eject Button: Push to eject a CD.

19. CD Slot: To play a CD, insert CD into slot with label facing up.

20. Display Area: This area displays all function information for the radios, clock and CD players.

Basic Operation

Turning the Unit On and Off: Push the **Power** button.



Selecting Play Source: Push the **Mode** button to choose a play source: Radio, Sirius Satellite Radio (if equipped), CD, External CD Changer (if equipped or Auxiliary Sources (if equipped).



Dimming the Display: Push and hold the **LOUD** button to dim the backlight of the display. Push and hold again to return to normal illumination.

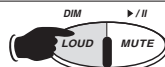

AM/FM Radio Operation

AM/FM Bands: Push **BAND** button to select a radio band: F1, F2, F3, AM1, AM2 or W (weather band).



Manual Tuning:

1. Rotate the **TUNE** knob left or right and hold until "MANUAL" appears in the display, then release knob.
2. Rotate the **TUNE** knob again left or right until the desired radio station appears in the display.

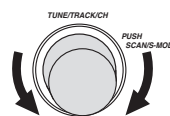

Scan Tuning: Push the **TUNE** knob to have the radio automatically scan every 5 seconds for a different radio station. To stop scanning push the **TUNE** knob again.

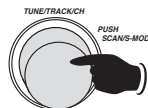

Seek Tuning: Rotate the **TUNE** knob left or right, then release to seek for a different radio station.

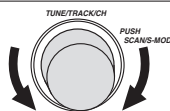

Preset AM/FM Radio Stations

Programming AM/FM Radio Stations: You can program up to 15 FM radio stations and 10 AM radio stations.

1. Select from F1, F2, F3, AM1 or AM2 by pushing the **BAND** button repeatedly.
2. Tune to the desired radio station (see AM/FM Radio Operation above for more details).
3. Push and hold one of the five **STATION RECALL** buttons until a short "beep" is heard. The corresponding preset button number now appears in the lower right hand corner of the display.
4. To program additional preset stations, repeat this procedure using the other **STATION RECALL** buttons.



Preset AM/FM Radio Stations (continued)

Automatically Programming AM/FM Radio Stations: You can program up to 15 FM radio stations and 10 AM radio stations automatically.

1. Select from F1, F2, F3, AM1 or AM2 by pushing the **BAND** button repeatedly.
2. Push and hold **AS/PS** button until the display starts scanning for a radio station. The radio will automatically program the 5 strongest station into preset memory.

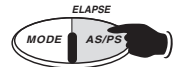

Recalling AM/FM Radio Stations:

1. Select from F1, F2, F3, AM1 or AM2 by pushing the **BAND** button repeatedly.
2. Push button 1, 2, 3, 4 or 5 to recall a pre-programmed radio station.



Automatically Recalling AM/FM Radio Stations:

1. Select from F1, F2, F3, AM1 or AM2 by pushing the **BAND** button repeatedly.
2. Push the **AS/PS** button and release to automatically scan every 5 seconds the through pre-programmed radio stations. To stop scanning push the **AS/PS** button again.



Weather Band Radio Operation

Weather Band: Push **W-BND** button to immediately access the weather band. The radio will search for the strongest weather band signal in your area.

Scan Tuning: Push the **TUNE** button (3) to scan every 5 seconds through all 7 weather band stations. To stop scanning push the **TUNE** knob again.

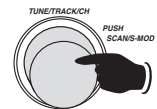

Sound Controls

Volume Control: Rotate the **VOLUME** knob to the right to increase levels or left to decrease levels.

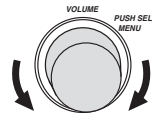

Bass, Treble, Balance and Fader Controls: Push and release the **VOLUME** knob to scan between the different sound controls. Once the desired function is in the display area rotate the knob left or right to achieve the desired level.

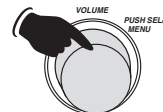

Bass Control: The bass control adjusts the amount of low frequency that you hear.

Treble Control: The treble control adjusts the amount of high frequency that you hear.

Balance Control: The balance control adjusts the amount of sound output to the left and right speakers.

Fader Control: The fader control adjusts the amount of sound output to the front and rear speakers.

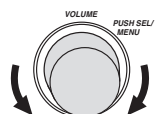
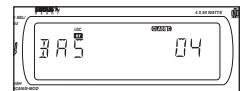

Sound Controls (continued)

Equalizer: Push the **EQ** button to choose between preset equalizer settings: Classic, Rock, DSP Off (digital sound processor off), Flat, Pop and Jazz, as indicated in the display area.



Mute (CD Play/Pause) Button: Push the **MUTE** button to mute the radio volume. If a CD is playing the **MUTE** button will pause the CD. Push the **MUTE** button again to restore the volume or resume playing the CD.



Loudness: Push the **LOUD** button to boost high and low tones at low volume levels.



Clock Setting

Display Button: Push and hold the **DISP** button until the clock is flashing in the display.

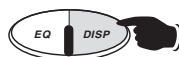

Adjusting the Minutes: Rotate the **TUNE** knob to the Left to adjust the Minutes.

Adjusting the Hours: Rotate the **TUNE** knob to the Right to adjust the Hours. Note: the AM/PM indicators.

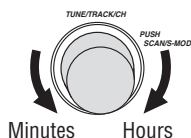

When correct time displays wait a few seconds to allow the time to program.

CD Operation

Playing a CD: Insert a CD (label side up) into the CD slot. The CD will auto-load and start playing.

Note: If a CD does not auto-load **DO NOT FORCE** into the slot, as you may already have a CD loaded.

CD Track Selection: Rotate the **TUNE** knob left or right to change the track. The track number will appear in the display.

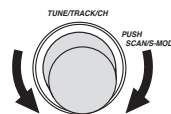

Pausing a CD: Push the **MUTE** button to "Pause" the disc, push again to resume play.

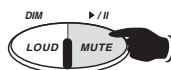

Ejecting a CD: Push the **EJECT** button to to eject a disc.



Repeating a CD Track: Select the desired track to repeat then push the **REPEAT** button until "S-RPT" appears in the display. The track on the disc will play repeatedly. To cancel this feature push the **REPEAT** button until "S-RPT" disappears from the display.



Random CD Track Play Order: Push the **SHUFFLE** button until "S-SHF" appears in the display. The tracks on the disc in a random order. To cancel this feature push the **SHUFFLE** button until "S-SHF" disappears from the display.



Preview CD Tracks: Push the **INTRO** button until "S-SCN" appears in the display. Each track on the disc will play for 10 seconds. To cancel this feature push the **INTRO** button until "S-SCN" disappears from the display.



Elapse Times: Push the **AS/PS** button to display running time of CD track, push the button again to display the time remaining on the CD track, push one more time to display time remaining on CD.

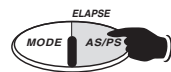

CD Operation (continued)

Programming CD Tracks into Memory:

1. In the CD mode, push the **MEMORY** button once. "P-01" will be displayed.



2. Select the desired track on the CD by rotating the **TUNE** knob.

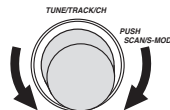

3. Push the **MEMORY** button again to store that track into memory.



4. Repeat Steps 2 and 3 to store up to 30 tracks into memory.

Note: To clear program memory, push the **MEMORY** button once during programmed playback. "CLEAR" will be displayed.

Playing Programmed CD Tracks:

1. Push the **Program** button to playback programmed tracks in memory. "PGM" will appear in the upper right corner of the display. To return to normal playback mode, push the **PROGRAM** button again.



CD Changer Operation

Load CD's: Insert the CD magazine into the external CD changer

Selecting the External CD Changer: Push the **MODE** button until "CDC" appears in the display.



CD Selection: Push button **1** or **2** to scroll through the selection of CD's in the CD changer. If a CD is not in one of the trays, the unit will continue until the next CD is found.

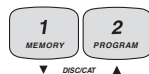

CD Track Selection: Rotate the **TUNE** knob left or right to change the track. The track number will appear in the display.

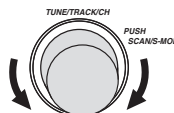

Repeating a CD Track: Select the desired track to repeat then push and release the **REPEAT** button and "RPT" appears in the display. The track on the disc will play repeatedly. To cancel this feature push the **REPEAT** button and "RPT" disappears in the display.



Repeating a CD: Select the desired CD to repeat then push and hold the **REPEAT** button and "DPT" appears in the display. The disc will play repeatedly. To cancel this feature push the **REPEAT** button and "DPT" disappears from the display.

Random CD Track Play Order: Push and release the **SHUFFLE** button until "SHF" appears in the display. The tracks on the disc will play in a random order. To cancel this feature push the **SHUFFLE** button until "SHF" disappears from the display.

Random CD Play Order: Push and hold the **SHUFFLE** button until "DSF" appears in the display. The discs will play in a random order. To cancel this feature push the **SHUFFLE** button until "DSF" disappears from the display.



CD Changer Operation (Continued)

Preview CD Tracks: Push and release the **INTRO** button until “SCN” appears in the display. Each track on the disc will play for 10 seconds. To cancel this feature push the **INTRO** button until “SCN” disappears from the display.



Preview CDs: Push and hold the **INTRO** button until “DSN” appears in the display. Each track on every disc will play for 10 seconds. To cancel this feature push the **INTRO** button until “DSN” disappears from the display.

Sirius Satellite Radio Setup

Note: If your Sirius tuner is not activated, call 1-888-539-SIRIUS to activate. The Sirius Tuner ID Number (ESN) is required during the activation process. Following the instructions below to access the Sirius Tuner ID Number (ESN):

Accessing your Sirius Tuner ID Number (ESN):

1. Push the **MODE** button until “SIRIUS” appears in the display area.
2. Push the **TUNE** button until “DIRECT” appears in the display area. Wait a few seconds and “CH 000” will then appear in the display.
3. Push the **BAND** button and the first 4 digits of the 12 digit Sirius Tuner ID Number (ESN) will be displayed.
4. Push the **DISP** button and the last 8 digits of your 12 digit Sirius Tuner ID Number (ESN) will be displayed.
5. Push the **TUNE** button to exit.

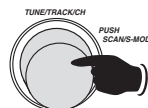
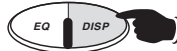
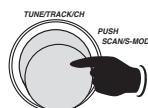

Sirius Satellite Radio Operation

Please note that satellite radio signal may be blocked by trees, buildings, bridges or tunnels.

Selecting Sirius Satellite Radio: Push the **MODE** button until “SIRIUS” appears in the display. Please be patient as it may take a minute to receive a satellite signal.



Manual Tuning:

1. Push the **TUNE** knob until “NORMAL” appears in the display.
2. Rotate the **TUNE** knob to select a station from 01-182.

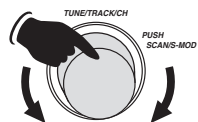

Category Tuning:

1. Push the **TUNE** knob until “CATEGORY” appears in the display.

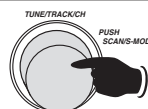

2. Push button 1 or 2 to find the desired category.



Sirius Satellite Radio Operation (Continued)

Category Tuning (continued):

3. Rotate the **TUNE** knob and select a station.

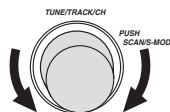

Direct Tuning:

1. Push the **TUNE** knob until "DIRECT" appears in the display.
2. Rotate the **TUNE** knob and select the first digit (0 or 1).
3. Push the **TUNE** knob again.
4. Rotate the **TUNE** knob and select the second digit (1-8).
5. Push the **TUNE** knob again.
6. Rotate the **TUNE** knob and select the third digit (1-9). The tuner will start playing the station you have selected when the third digit stops flashing.

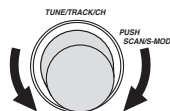
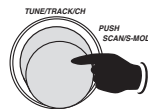

Preset Sirius Satellite Radio Stations

Programming Satellite Radio Stations: You can program up to 20 Sirius Satellite radio stations.

1. Select from SR1, SR2, SR3 or SR4 by pushing the **BAND** button repeatedly.
2. Tune to the desired radio station (see Sirius Satellite Radio Operation for more details).
3. Push and hold one of the five **STATION RECALL** buttons until a short "beep" is heard. The corresponding preset button number now appears in the lower right hand corner of the display.
4. To program additional preset stations, repeat this procedure using the other **STATION RECALL** buttons as desired.



Recalling Satellite Radio Stations:

1. Select from SR1, SR2, SR3 or SR4 by pushing the **BAND** button repeatedly.
2. Push button 1, 2, 3, 4 or 5 to recall a pre-programmed radio station.



Automatically Recalling Satellite Radio Stations:

1. Select from SR1, SR2, SR3 or SR4 by pushing the **BAND** button repeatedly.
2. Push **AS/PS** button and release to automatically scan every 5 seconds the pre-programmed radio stations. To stop scanning push the **AS/PS** button again.



Channel Skip Sirius Satellite Radio

Programming Channel Skip for Satellite Radio Stations: You can program the radio to skip channels which you do not want.

1. Tune to the station to be skipped (see Sirius Satellite Radio Operation for more details).
2. Push the **TUNE** knob until “SET SKIP” appears in the display.
3. Push the **BAND** button and “SKIP” will appear flashing in the bottom of the display. When the “SKIP” stops flashing the channel has been programmed to skip.

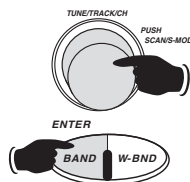

Release Channel Skip for Satellite Radio Stations:

1. Push the **TUNE** knob until “DIRECT” appears in the display.
2. Rotate the **TUNE** knob and select the first digit of the skipped channel (0 or 1).
3. Push the **TUNE** knob again.
4. Rotate the **TUNE** knob and select the second digit of the skipped channel (1-8).
5. Push the **TUNE** knob again.
6. Rotate the **TUNE** knob and select the third digit of the skipped channel (1-9). The tuner will start playing the station you have selected when the third digit stops flashing.
7. Push the **TUNE** knob until “SET SKIP” appears in the display. After a few seconds the radio channel will appear in the display with “SKIP” flashing at the bottom.
8. Push the **BAND** button and “SKIP” will stop flashing in the bottom of the display. When the “SKIP” disappears the channel has been released from Channel Skip.

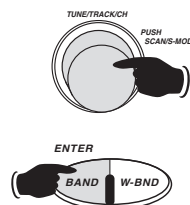
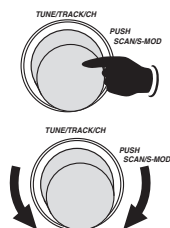

Auxiliary Input

Selecting Auxiliary Input: Push the **MODE** button until “AUX1” or “AUX2” appears in the display which indicates that the auxiliary unit is playing through the M9900CDS.

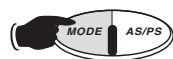

Note: All sound controls (pages 5-6) are active when the Auxiliary source is playing.

Speciality Features

Display Button: The factory default setting is clock display priority. Push the **DISPLAY** button at any time will display the radio frequency, CD track, AUX 1 or AUX 2.

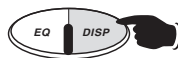

Note: In the Sirius mode the factory default setting is Sirius channel display priority. Push the **DISPLAY** button at any time to display the CN-NAME, SONG TITLE, ARTIST, CATEGORY and Clock. If clock is chosen the time will be displayed for approximately 5 seconds then revert to displaying the Category.

Reset Button: The radio panel or LCD display may fail to function normally due to the vehicle's battery condition, and may require resetting the radio microprocessor if:

- The vehicle has been "jump started" from a dead battery condition.
- The vehicle battery becomes very low and is quick-charged.
- The vehicle battery is removed and replaced.

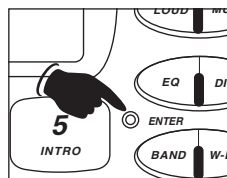

Should this condition occur, simply press and release the **RESET** button on the radio panel using the tip of a ball point pen. This will reset the radio microprocessor to the original factory settings. After pressing the **RESET** button you should recheck to see if the radio functions normally. All station programming should remain, but you will have to reset the clock. Should the LCD display area show any abnormal error code, please refer to the trouble shooting guide and solution chart below.

Error Code	Problem	Description	Possible Remedy
ERR 1	Mechanism Problem	Unknown mechanical problem with the CD mechanism.	<ol style="list-style-type: none"> 1. Eject the disc and try another. 2. Press the reset button. 3. Replace the unit.
ERR 2	TOC Reading Error	Laser can not read the CD disc table of contents.	<ol style="list-style-type: none"> 1. Insert a different disc. 2. Check disc for excessive scratches. 3. Check disc for dirt and fingerprints. Clean disc and reinsert.
ERR 3	Error from High Ambient Temp.	The temperature of the mechanism is too high to play CDs without damaging them.	Reduce the temperature inside the vehicle and try to play a CD at a later time.
ERR 4	Laser Focus Error	Laser pickup fails to focus and read the disc.	<ol style="list-style-type: none"> 1. Insert a different disc. 2. Check disc for excessive scratches. 3. Check disc for dirt and fingerprints. Clean disc and reinsert. 4. Press the reset button.
ERR 6	CD Loading Error	The loading mechanism is damaged.	<ol style="list-style-type: none"> 1. Push the reset button. 2. Replace the unit.
ERR 7	Laser Servo Error	Laser servo is not functional.	<ol style="list-style-type: none"> 1. Press the reset button. 2. Replace the unit.

Default Settings

The M9900CDS has a small group of settings that can be changed to suit your personalized requirement.

Button Confirmation Beep: The factory default setting is BEEP ON (a confirmation beep every time a button or knob is pushed). To turn the beeps off, push and hold the **VOLUME** knob until “BEEP ON” is in the display then release. Rotate the VOLUME knob until “BEEP OFF” is in the display. Wait a few seconds, the radio will return to last radio mode selected.

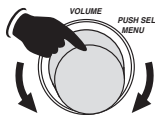

Power Up Volume Level: The factory default setting for initial power-up volume level is 12. To change the initial volume level, push and hold the **VOLUME** knob until “BEEP ON” is in the display then release. Push the **VOLUME** knob until “P-VOL” is in the display. Rotate the VOLUME knob until the desired initial volume is achieved. Wait a few seconds, the radio will return to last radio mode selected.

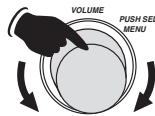

Radio Frequency Display: The factory default setting is USA. Do not change this setting.

Clock Display When the Radio is Off: When the ignition key is on and the radio is off, “clock display on” is the default setting. To change the setting to “clock display off”, push and hold the **VOLUME** knob until “BEEP ON” is in the display then release. Push the **VOLUME** knob until “CLK ON” is in the display. Rotate the VOLUME knob until “CLK OFF” is in the display. Wait a few seconds, the radio will return to last radio mode selected.

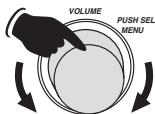

Display Priority: The factory default setting for display priority is “CLOCK” except in Sirius mode. To change the display priority (either radio frequency priority or no priority), push and hold the **VOLUME** knob until “BEEP ON” is in the display then release. Push the **VOLUME** knob until “CLOCK” is in the display. Rotate the VOLUME knob until “FREQ” or “NO PRI” is in the display. Wait a few seconds, the radio will return to last radio mode selected.

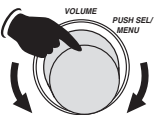

Clock Type, 12 hour or 24 hour: The factory default setting is 12 hour clock with AM and PM indication. To change the clock type to 24 hour military time, push and hold the **VOLUME** knob until “BEEP ON” is in the display then release. Push the **VOLUME** knob until “12 HOUR” is in the display. Rotate the VOLUME knob until “24 HOUR” is in the display. Wait a few seconds, the radio will return to last radio mode selected.

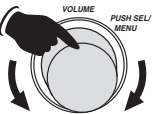

Installation

Step 1: The radio chassis is designed to be "Sleeve Mounted" through a opening in the dashboard panel. The required opening size is 182mm (7-3/16") x 84mm (3-5/16"). Cut or engage an opening in the dashboard to accommodate the mounting sleeve.

Step 2: Insert the mounting sleeve into the hole in the dashboard. Bend the metal tabs on the sleeve to secure the mounting sleeve to the dashboard.

Step 3: Bring all wiring for the connection of the unit (including the antenna) through the center of the mounting sleeve. Connect the wiring as follows:

Yellow Wire (w/Fuse): Connect this wire to a constant +12 volt power source (a power source that is not controlled by the ignition key).

Red Wire: Connect this wire to a switched +12 volt power source (a power source turned on and off by the ignition key).

Blue Wire: Connect this wire to the (+) power antenna activation circuit. If no power antenna exists, tape-off the end of this wire to prevent shorting out the unit.

Black Wire: Connect this wire to the frame of the vehicle (ground). This wire is the chassis grounding wire for the unit.

White Wire: Connect this wire to the Left Front Speaker (+) positive terminal or wire.

White Wire with Black Stripe: Connect this wire to the Left Front Speaker (-) negative terminal or wire.

Green Wire with Black Stripe: Connect this wire to the Left Rear Speaker (-) negative terminal or wire.

Green Wire: Connect this wire to the Left Rear Speaker (+) positive terminal or wire.

Gray Wire: Connect this wire to the Right Front Speaker (+) positive terminal or wire.

Gray Wire with Black Stripe: Connect this wire to the Right Front Speaker (-) negative terminal or wire.

Purple Wire with Black Stripe: Connect this wire to the Right Rear Speaker (-) negative terminal or wire.

Purple Wire: Connect this wire to the Right Rear Speaker (+) positive terminal or wire.

Note: This unit is designed to connect to (4) four speakers. If the installation only requires (2) two speakers, use the White and Gray wire sets to connect the speakers.

WARNING! Any wires left unconnected must be taped-off or capped off to prevent shorting.

DO NOT connect speaker ground wires together.

DO NOT connect speaker ground wires to the chassis of the vehicle.

DO NOT connect front and rear speaker wires together.

FAILURE TO FOLLOW ANY OF THESE WARNINGS WILL RESULT IN DAMAGE TO THIS UNIT AND VOIDS THE WARRANTY.

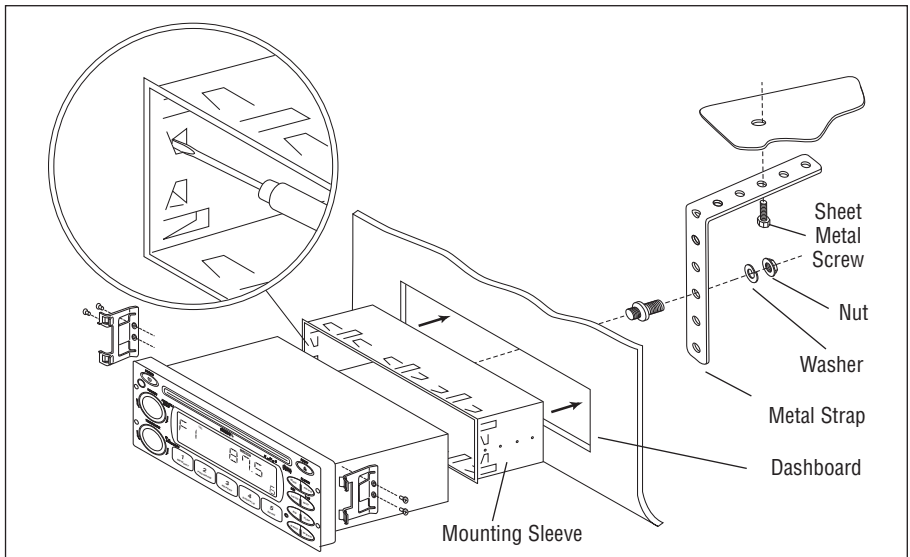

Speaker Connection

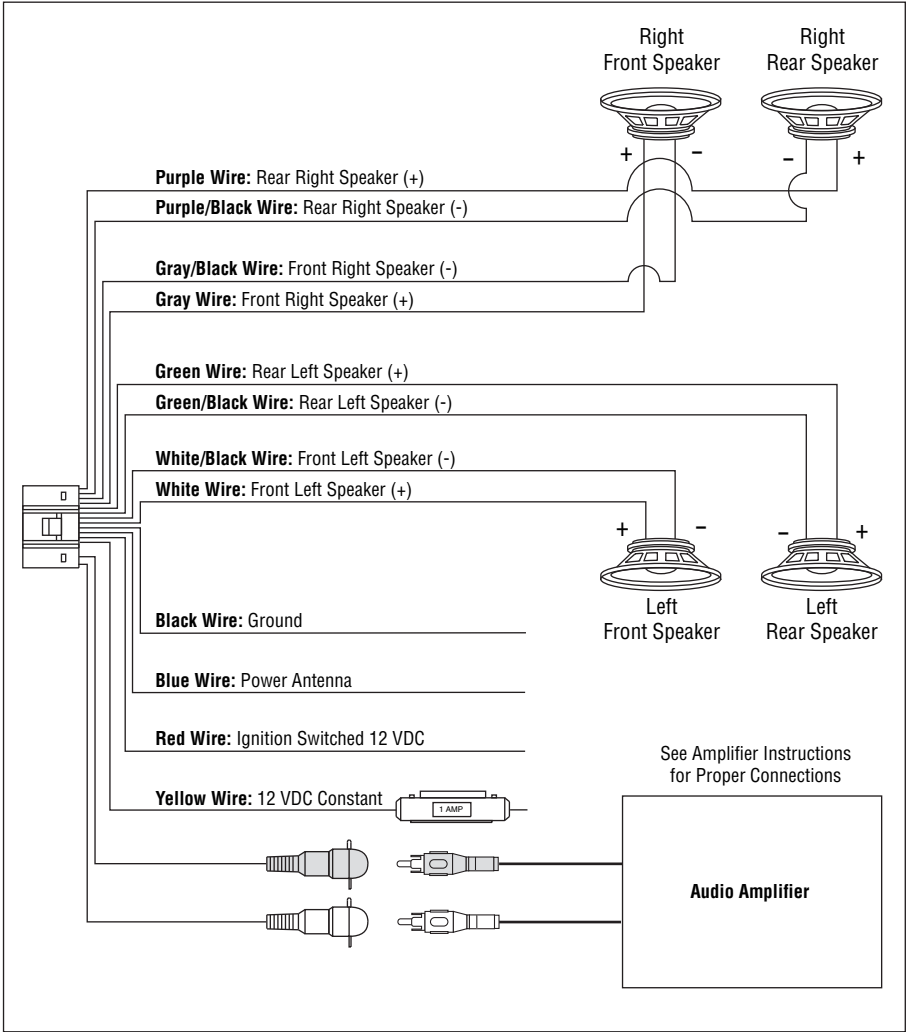

Sirius Tuner Connection (Optional)

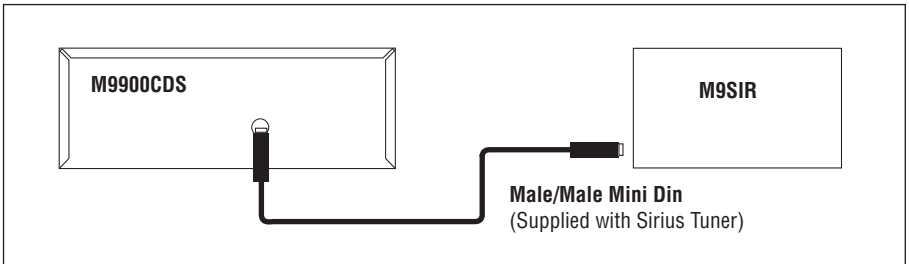

Auxiliary Connection

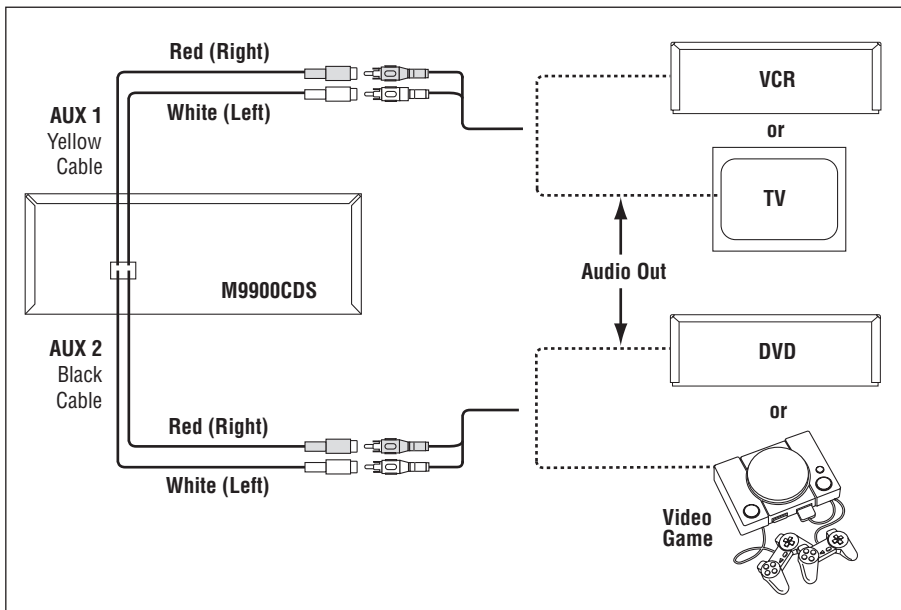

CD Changer Connection

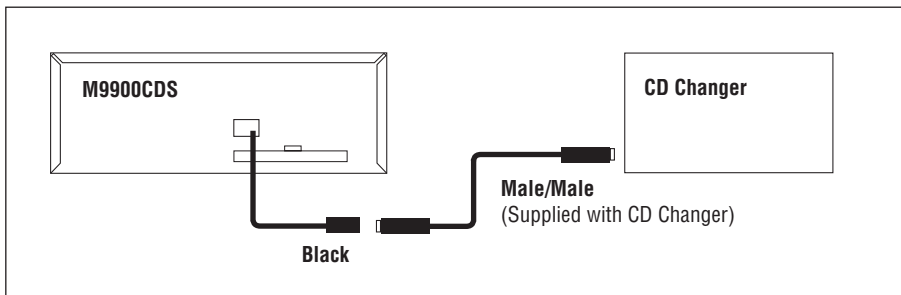

Remote IR Sensor Connection (Optional)

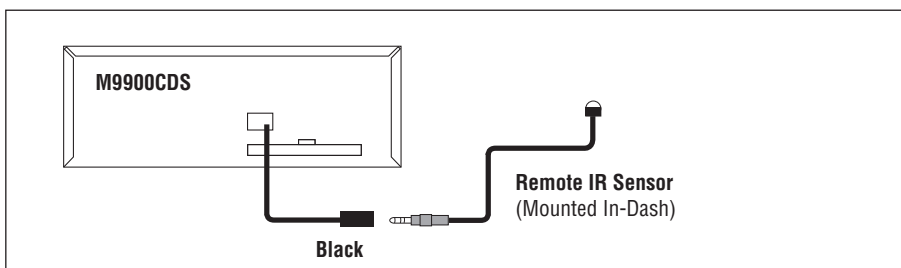

ONE (1) YEAR LIMITED WARRANTY

Magnadyne Corporation or its authorized agents will within one year from the date of sale to you, repair, replace or refund the retail sales price of said product or any part thereof, at the option of the Magnadyne Corporation or its authorized agents, if said product or part is found defective in materials or workmanship, when properly connected and operating on the correct power requirements designated for the specific product. This warranty and Magnadyne Corporation or its authorized agent's obligations hereunder do not apply where the product was; damaged while in the possession of the consumer, subjected to unreasonable or unintended use, not reasonably maintained, utilized in commercial or industrial operations, or serviced by anyone other than Magnadyne Corporation or its authorized agents, or where the warning seal on the product is broken or the power and/or plugs are detached from the unit. Magnadyne Corporation or any of its authorized agents will not assume any labor costs for the removal and reinstallation of any product found to be defective, or the cost of transportation to Magnadyne Corporation or its authorized agents. Such cost are the sole responsibility of the purchaser.

This warranty does not cover the cabinet appearance items or accessories used in connection with this product, or any damage to recording or recording tape, or any damage to the products resulting from improper installation, alteration, accident, misuse, abuse or acts of nature.

MAGNADYNE CORPORATION OR ITS AUTHORIZED AGENTS SHALL NOT BE LIABLE TO ANYONE FOR CONSEQUENTIAL OR INCIDENTAL DAMAGES OR CLAIMS EXCEPT THOSE ACCORDED BY LAW. NO EXPRESSED WARRANTY OR IMPLIED WARRANTY IS GIVEN EXCEPT THOSE SET FORTH HEREIN. NO IMPLIED WARRANTY SHALL EXTEND BEYOND ONE YEAR FROM THE DATE OF SALE.

This warranty extends only to the original purchaser of the product and is not transferable. Some states do not allow limitations on how long an implied warranty lasts, and some states do not allow the exclusion or limitation of incidental or consequential damages, so the above limitations or exclusion may not apply to you. This warranty gives you specific legal rights, and you may have other rights that vary from state to state.

“NOTE: The manufacturer is not responsible for any radio or TV interference caused by unauthorized modifications to this equipment. Such modifications could void the User's authority to operate the equipment.”

Defective merchandise should be returned to the original point of purchase or secondly, to Magnadyne Corporation, 1111 W. Victoria Street, Compton CA 90220.

Return Authorization must be obtained before sending, or merchandise may be refused.