

KENWOOD

CD-RECEIVER

KDC-W5641U

KDC-W5541U

KDC-W5141U

KDC-W5041U

KDC-W4141

KDC-W4041

INSTRUCTION MANUAL

Kenwood Corporation



Contents

Before use	3	Appendix	15
Basic Operation	4	Accessories/ Installation Procedure	18
General functions		Connecting Wires to Terminals	19
Tuner functions		Installation/Removing the Unit	21
Disc & Audio file play functions		Troubleshooting Guide	22
General Operation	6	Specifications	24
Audio Control			
Audio Setup			
Speaker Setting			
Display Switching			
Tuner Operation	8		
PTY (Program Type)			
Program Type preset			
Changing Language for PTY Function			
Direct Access Tuning			
Music disc/Audio file Operation	9		
Play Functions of Disc Changer			
Direct Music Search			
Direct Disc Search			
List Select			
iPod Select			
Track Select			
Menu Operation	11		
Menu System			
Security Code			
Manual Clock Adjustment			
Auxiliary Input Display Setting			
Demonstration mode Setting			
Basic Operations of remote control	14		

Panel illustrations used in this document

The control panel for KDC-W5641U is used to describe operations in this document.

Playing AAC, MP3, and WMA data

This document refers to AAC, MP3, and WMA data stored in iPod, USB device, and CD-R/RW as "audio files." Refer to the section on "Audio Files" to control these data. See <About Audio file> (page 15) for details.

- iPod is a trademark of Apple Inc., registered in the U.S. and other countries.
- The "AAC" logo is trademark of Dolby Laboratories.

Before use

⚠ WARNING

To prevent injury or fire, take the following precautions:

- To prevent a short circuit, never put or leave any metallic objects (such as coins or metal tools) inside the unit.

Before using this unit for the first time

This unit is initially set on the Demonstration mode. When using this unit for the first time, cancel the <Demonstration mode Setting> (page 13).

How to reset your unit

- If this unit or the connected unit (disc auto changer, etc.) fails to operate properly, press the Reset button. The unit returns to factory settings when the Reset button is pressed.

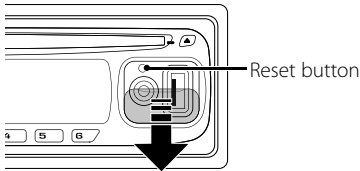

Cleaning the Unit

If the faceplate of this unit is stained, wipe it with a dry soft cloth such as a silicon cloth. If the faceplate is stained badly, wipe the stain off with a cloth moistened with neutral cleaner, then wipe it again with a clean soft dry cloth.



- Applying spray cleaner directly to the unit may affect its mechanical parts. Wiping the faceplate with a hard cloth or using a volatile liquid such as thinner or alcohol may scratch the surface or erase characters.

Cleaning the Faceplate Terminals

If the terminals on the unit or faceplate get dirty, wipe them with a clean soft dry cloth.

Lens Fogging

When you turn on the car heater in cold weather, dew or condensation may form on the lens in the CD player of the unit. Called lens fogging, this condensation on the lens may not allow CDs to play. In such a situation, remove the disc and wait for the condensation to evaporate. If the unit still does not operate normally after a while, consult your Kenwood dealer.

- If you experience problems during installation, consult your Kenwood dealer.
- When you purchase optional accessories, check with your Kenwood dealer to make sure that they work with your model and in your area.
- The characters which can be displayed by this unit are A-Z 0-9 @ " ' ` % & * + = , . / \ < > [] () ; : ^ - { } | ~ .
- The RDS feature won't work where the service is not supported by any broadcasting station.
- The illustrations of the display and the panel appearing in this manual are examples used to explain more clearly how the controls are used. Therefore, what appears on the display in the illustrations may differ from what appears on the display on the actual equipment, and some of the illustrations on the display may be inapplicable.

Handling CDs

- Do not touch the recording surface of the CD.
- Do not stick tape etc. on the CD, or use a CD with tape stuck on it.
- Do not use disc type accessories.
- Clean from the center of the disc and move outward.
- When removing CDs from this unit, pull them out horizontally.
- If the CD center hole or outside rim has burrs, use the CD only after removing the burrs with a ballpoint pen etc.

CDs that cannot be used

- CDs that are not round cannot be used.

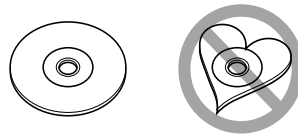

- CDs with coloring on the recording surface or CDs that are dirty cannot be used.

- This unit can only play the CDs with 

This unit may not correctly play discs which do not have the mark.

- You cannot play a CD-R or CD-RW that has not been finalized. (For the finalization process refer to your CD-R/CD-RW writing software, and your CD-R/CD-RW recorder instruction manual.)

Basic Operation

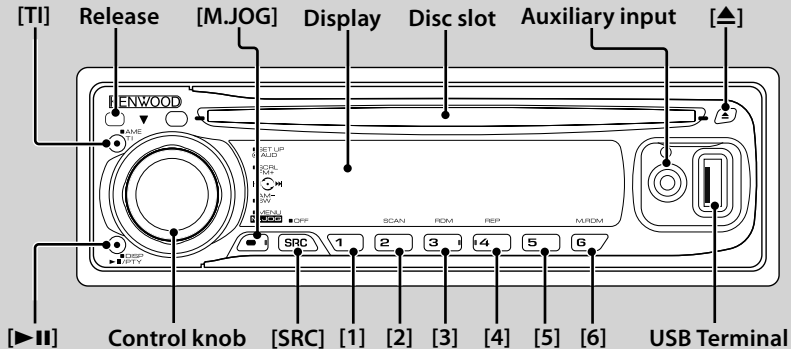

General functions

Power/Source select button [SRC]

Turns on the power.

When the power is on, the source switches between Tuner ("TUNER"), USB or iPod ("USB" or "iPod"), CD ("CD"), Auxiliary input ("AUX"), and Standby ("STANDBY") each time this button is pressed. Press at least 1 second to turn off the power.



- When the power is ON, the <Security Code> (page 12) is displayed as "CODE ON" or "CODE OFF".
- For whether USB devices and iPod can be connected, refer to <About Audio file> (page 15).
- When an optional accessory is connected, the source name for each device appears.
- This unit automatically turns full power OFF after 20 minutes lapses in Standby mode in order to save the vehicle's battery. The time until full power OFF can be set in "POWER OFF" of <Menu System> (page 11).
- When connection of the iPod is recognized, the source display changes from "USB" to "iPod".

Volume control Control knob

Turn the knob to adjust the volume.

Faceplate release Release

Releases the faceplate lock so that it can be removed. Refer to the following diagram when reattaching the faceplate.

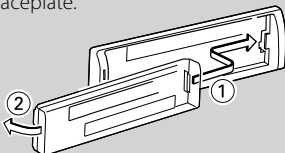

- The faceplate is a precision piece of equipment and can be

damaged by shocks or jolts.

- Keep the faceplate in its faceplate case while detached.
- Do not place the faceplate (and the faceplate case) in areas exposed to direct sunlight, excessive heat or humidity. Also avoid places with too much dust or the possibility of water splashing.
- To prevent deterioration, do not touch the terminals of the unit or faceplate with your fingers.

Auxiliary input Auxiliary input

Used to connect a portable audio device with mini-plug cable (3.5 ϕ).



- Use the mini-plug cable (stereo) which does not have any resistance.

Muting volume upon reception of phone call

When there is a call, "CALL" is displayed and the audio system is paused.

When the call ends, "CALL" disappears and the audio system comes back on.

The audio system comes back on when [SRC] is pressed during a call.

Subwoofer output Control knob

Switches between ON ("SUBWOOFER ON") and OFF ("SUBWOOFER OFF") each time pushing toward down for at least 2 seconds.

Text/Title scroll Control knob

Scrolls the CD, audio file, and Radio text display when pushing toward up for at least 2 seconds.

Tuner functions

Band select Control knob

Switches between FM1, FM2, and FM3 each time pushing toward up.

Switches to AM when pushing toward down.



: Indicates the button etc. to operate.

Tuning **Control knob**

Changes the frequency when pushing toward left or right.



- During reception of stereo stations the “ST” indicator is ON.

Traffic information **[TI]**

Turns ON or OFF the Traffic Information function.

When the function is turned ON, “TI” indicator is ON. If traffic bulletin starts when the function is ON, “TRAFFIC INFO” is displayed and traffic information is received.



- If the volume is adjusted during reception of traffic information, the adjusted volume is memorized automatically. The memorized volume will be applied next time the Traffic Information function is turned ON.

Preset memory **[1] - [6]**

Memorizes the station selected when pressing for at least 2 seconds.

Auto memory entry **[TI]**

Memorizes six stations with good reception automatically when pressed for at least 2 seconds.

Preset tuning **[1] - [6]**

Recalls the memorized station.

Disc & Audio file play functions

Disc play **Disc slot**

Starts playing when a disc is inserted.

When a CD is inserted, the “IN” indicator is ON.



- 3 inch (8 cm) CD cannot be used. Attempt to insert using an adapter can cause malfunction.

USB device play (KDC-W5641U/W5541U/W5141U/

W5041U) **USB Terminal**

Used to connect the USB device to the USB cable (optional accessory) which is connected to the USB terminal.

When the USB device is connected, the “USB” indicator is ON.



- For the playable audio file, media, and devices, refer to <About Audio file> (page 15).

Pause and play **[II]**

Switches between pause and play each time this button is pressed.

Disc ejection **[▲]**



- You can eject the disc for 10 minutes after switching off the engine.

USB device removing **[▲]**

Press this button for 2 seconds or longer to select the remove mode, and the remove the USB device. During the remove mode, “USB REMOVE” is displayed.

Music search **Control knob**

Changes the music when pushing toward left or right. Fast reverses or forwards the music while keeping pushing toward left or right. (No sound is output while playing audio file.)

Folder search **Control knob**

Changes the folder containing the audio file when pushing toward up or down.

Select mode **[M.JOG]**

After pressing this button, you can quickly search songs with the control knob. See <List Select> (page 10), <iPod Select> (page 10) for details.

Track/ File/ Folder repeat play **[4]**

Switches between Track Repeat (“TRAC REP ON”) and OFF (“REP OFF”) when pressed while playing a CD.

Switches between File Repeat (“FILE REP ON”), Folder Repeat (“FOLD REP ON”), and OFF (“REP OFF”) when pressed while playing an audio file.



- The folder repeat operation cannot be performed while iPod is playing.

Scan play **[2]**

Successively plays the intro of the music in the disc or folder.

When Scan Play is turned on, “TRAC SCAN ON”/ “FILE SCAN ON” is displayed.



- The Scan play operation cannot be performed while iPod is playing.

Random play **[3]**

Randomly plays the music in the disc or folder.

When Random Play is turned on, “DISC RDM ON”/ “FOLD RDM ON” is displayed.

General Operation

Audio Control

You can adjust following Audio Control items;

Adjustment Item	Display	Range
Rear volume*	"R-VOLUME"	0 — 35
Subwoofer level	"SUB-W L"	-15 — +15
Bass Boost**	"B.BOOST-L"	"L1"/"L2"/"OFF" (The indicator turns on according to the setting.)
System Q	"NATURAL"/ "USER"/"ROCK"/ "POPS"/"EASY"/ "TOP40"/"JAZZ"	Natural/User setting/Rock/ Pops/Easy/Top 40/Jazz (The indicator turns on according to the setting.)
Bass level	"BASS L"	-8 — +8
Middle level	"MID L"	-8 — +8
Treble level	"TRE L"	-8 — +8
Balance	"BALANCE"	Left 15 — Right 15
Fader	"FADER"	Rear 15 — Front 15

Exit Audio Control mode (Volume control mode)

*Function of KDC-W5641U/W5541U/W5141U/W5041U.

**Function of KDC-W4141/W4041.



- "USER": The customized Bass, Middle, and Treble levels are effective. On the KDC-W5641U/W5541U/W5141U/W5041U, this item can be selected at any time. On the KDC-W4141/W4041, this item is displayed only when the tone quality has been adjusted. On the KDC-W4141/W4041, this item disappears when another setting is selected.
- You can set Bass, Middle, and Treble for each source.

1 Select the source to adjust

Press the [SRC] button.

2 Enter Audio Control mode

Press the Control knob.

3 Select the Audio item to adjust

Press the Control knob.

4 Adjust the Audio item

Turn the Control knob.

5 Exit Audio Control mode

Press any button.

Press a button other than the Control knob or ▲ button.

Audio Setup

You can set Sound system, such as follows;

Adjustment Item	Display	Range
Front High Pass Filter*	"HPF F"	Through/80/100/120/ 150/180 Hz
Rear High Pass Filter*	"HPF R"	Through/80/100/120/ 150/180 Hz
Low Pass Filter	"LPF SW"	60* ¹ /80/120/160* ² /Through Hz
Subwoofer Phase*	"PHASE"	Reverse (180°)/ Normal (0°)
Volume offset	"V-OFFSET"	-8 — ±0 (AUX: -8 — +8)
Loudness*	"LOUDNESS"	OFF/ON
Dual Zone System*	"2ZONE"	OFF/ON

*Function of KDC-W5641U/W5541U/W5141U/W5041U.

*KDC-W5641U/W5541U/W5141U/W5041U only.

*²KDC-W4141/W4041 only.



- Volume offset: Sets each source's volume as a difference from the basic volume.
- Loudness: Compensates for low and high tones during low volume. (Only the low tone is compensated for when the tuner is selected as a source.)
- Dual Zone System
 - Main source and sub source (Auxiliary input) output Front channel and Rear channel separately.
 - Set up the channel of sub source by "ZONE2" of <Menu System> (page 11).
 - Select Main source by [SRC] button.
 - Adjust the volume of Front channel by Control knob.
 - Adjust the volume of Rear channel by <Audio Control> (page 6).
 - The Audio Control has no effect on sub source.

1 Select the source to adjust

Press the [SRC] button.

2 Enter Audio Setup mode

Press the Control knob for at least 1 second.

3 Select the Audio Setup item to adjust

Press the Control knob.

4 Adjust the Audio setup item

Turn the Control knob.

5 Exit Audio Setup mode

Press the Control knob for at least 1 second.

Speaker Setting

Fine-tuning so that the System Q value is optimal when setting the speaker type as follows;

Speaker type	Display
OFF	"SP SEL OFF"
For 5 & 4 in. speaker	"SP SEL 5/4"
For 6 & 6x9 in. speaker	"SP SEL 6*9/6"
For the OEM speaker	"SP SEL OEM"

1 Enter Standby

Press the [SRC] button.

Select the "STANDBY" display.

2 Enter Speaker Setting mode

Press the Control knob.

3 Select the Speaker type

Turn the Control knob.

4 Exit Speaker Setting mode

Press the Control knob.

Display Switching

Changes displayed information on each source following;

In Tuner source

Information	Display
Program Service name or Frequency	"FREQUENCY/PS"
Radio text, Program Service name or Frequency	"RADIO TEXT"
Clock	"CLOCK"

In CD & External disc source

Information	Display
Disc title	"DISC TITLE"
Track title (In External disc source)	"TRACK TITLE"
Play time & Track number	"P-TIME"
Clock	"CLOCK"

In Audio file source

Information	Display
Music title & Artist name	"TITLE/ARTIST"
Album name & Artist name	"ALBUM/ARTIST"
Folder name	"FOLDER NAME"
File name	"FILE NAME"
Play time & Music number	"P-TIME"
Clock	"CLOCK"

In Standby/ Auxiliary input source

Information	Display
Source name	"SOURCE NAME"
Clock	"CLOCK"

1 Enter Switching Display mode

Press the [▶II] button for at least 1 second.

"DISPLAY SEL" is displayed.

2 Select the Display item

Push the Control knob towards right or left.

3 Exit Switching Display mode

Press the [▶II] button.



- When you select the clock display, the display setting of each source will be changed to the clock display.
- If the selected display item does not have any information, alternative information is displayed.
- When selecting "FOLDER NAME" while playing with iPod, names will be displayed depending on currently selected browsing items.

Tuner Operation

PTY (Program Type)

Selecting the Program Type below and searching for a station;

No.	Program Type	Display
1.	Speech	"SPEECH"
2.	Music	"MUSIC"
3.	News	"NEWS"
4.	Current Affairs	"AFFAIRS"
5.	Information	"INFO"
6.	Sport	"SPORT"
7.	Education	"EDUCATE"
8.	Drama	"DRAMA"
9.	Culture	"CULTURE"
10.	Science	"SCIENCE"
11.	Varied	"VARIED"
12.	Pop Music	"POP M"
13.	Rock Music	"ROCK M"
14.	Easy Listening Music	"EASY M"
15.	Light Classical	"LIGHT M"
16.	Serious Classical	"CLASSICS"
17.	Other Music	"OTHER M"
18.	Weather	"WEATHER"
19.	Finance	"FINANCE"
20.	Children's programs	"CHILDREN"
21.	Social Affairs	"SOCIAL"
22.	Religion	"RELIGION"
23.	Phone In	"PHONE IN"
24.	Travel	"TRAVEL"
25.	Leisure	"LEISURE"
26.	Jazz Music	"JAZZ"
27.	Country Music	"COUNTRY"
28.	National Music	"NATION M"
29.	Oldies Music	"OLDIES"
30.	Folk Music	"FOLK M"
31.	Documentary	"DOCUMENT"



- Speech and Music include the Program type shown below.

Music: No.12 — 17, 26 — 30

Speech: No.3 — 11, 18 — 25, 31

1 Enter PTY mode

Press the [▶II] button.

During PTY mode the "PTY" indicator is ON.



- This function cannot be used during a traffic bulletin or AM reception.

2 Select the Program Type

Push the Control knob towards up or down.

3 Search for the selected Program Type station

Push the Control knob towards right or left.



- When the selected Program Type is not found, "NO PTY"

is displayed. Select another Program Type.

4 Exit PTY mode

Press the [▶II] button.

Program Type preset

Putting the Program Type in the Preset button memory and quick recall.

Presetting the Program Type

1 Select the Program Type to preset

Refer to <PTY (Program Type)>.

2 Preset the Program Type

Press the desired [1] — [6] button for at least 2 seconds.

Recalling the preset Program Type

1 Enter PTY mode

Refer to <PTY (Program Type)>.

2 Recall the Program Type

Press the desired [1] — [6] button.

Changing Language for PTY Function

Selecting the Program Type display language as follows;

Language	Display
English	"ENGLISH"
French	"FRENCH"
German	"GERMAN"

1 Enter PTY mode

Refer to <PTY (Program Type)>.

2 Enter Changing Language mode

Press the [TI] button.

3 Select the language

Push the Control knob towards up or down.

4 Exit Changing Language mode

Press the [TI] button.

Music disc/Audio file Operation

Function of remote control

Direct Access Tuning

Entering the frequency and tuning.

1 Enter Direct Access Tuning mode

Press the [DIRECT] button on the remote control.

"- - - -" is displayed.

2 Enter the frequency

Press the number buttons on the remote control.

Example:

Desired frequency	Press button
92.1 MHz (FM)	[0], [9], [2], [1]
810 kHz (AM)	[0], [8], [1], [0]

Cancelling Direct Access Tuning

Press the [DIRECT] button on the remote control.



- You can enter the FM band frequency in steps of a minimum of 0.1 MHz.

Play Functions of Disc Changer

While a disc in the disc changer is being played, the following play functions can be used.

Playing the Current Song or Disc Repeatedly. (Repeat play)

Press the [4] button.

Pressing the button repeatedly selects Track Repeat play on ("TRAC REP ON"), Disc Repeat play on ("DISC REP ON"), and Repeat play off ("REP OFF") sequentially.

Randomly plays the music in the disc changer. (Magazine random play)

Press the [6] button.

Pressing the button toggles the setting between Magazine random play on ("MGZN RDM ON") and off ("RDM OFF").

Function of remote control

Direct Music Search

Searches the music by entering the track number.

1 Enter the music number

Press the number buttons on the remote control.

2 Search the music

Press the [◀◀] or [▶▶] button.

Cancelling Direct Music Search

Press the [▶||] button.



- Direct Music Search cannot be performed during playing of iPod, Random play, or scan play.

Music disc/Audio file Operation

Function of disc changers with remote control

Direct Disc Search

Searchs the disc by entering the disc number.

1 Enter the disc number

Press the number buttons on the remote control.

2 Search the disc

Press the [FM] or [AM] button.

Canceling Direct Disc Search

Press the [▶II] button.



- Input "0" to select disc 10.
- Direct Disc Search cannot be performed during playing of Random play or scan play.

Function of USB/CD of Audio file

List Select

Search for the song you want to listen to by tracing the media file structure.

1 Enter Multi Jog Select mode

Press the [M.JOG] button.

"MULTI JOG ON" is displayed.

Displays the current Audio file name.

2 Searching for and playing a song

Operation type	Operation
Movement between folders/files	Turn the Control knob.
Selection of folder/file	Press the Control knob.
Return to previous folder	Push the Control knob towards left.
Return to root folder	Push the Control knob towards left for at least 2 seconds.

"<" or ">" beside the displayed folder name indicates that this folder is preceded or followed by another folder.

When file name is displayed, "*" is added at the end.

Canceling the Multi Jog Select mode

Press the [M.JOG] button.



- List Select cannot be performed during Random play or scan play.

Function of KDC-W5641U/KDC-W5541U

Function of iPod

iPod Select

Search for the song you want to listen to by selecting the same menu item as that of iPod.

1 Enter Multi Jog Select mode

Press the [M.JOG] button.

"MULTI JOG ON" is displayed.

Displays the play list.

2 Searching for and playing a song

Operation type	Operation
Movement between items	Turn the Control knob.
Selection of item	Press the Control knob.
Return to previous item	Push the Control knob towards up.
Return to Top menu	Push the Control knob towards up for at least 2 seconds.

Canceling the Multi Jog Select mode

Press the [M.JOG] button.



- iPod Select cannot be performed during Random play.

Function of Music CD

Track Select

Select the song you want to listen to by turning the control knob.

1 Enter Multi Jog Select mode

Press the [M.JOG] button.

"MULTI JOG ON" is displayed.

Displays the current music No.

2 Select the music

Turn the Control knob.

3 Play the selected song

Press the Control knob.

The Multi Jog Select mode is canceled and the selected song is played.

Canceling the Multi Jog Select mode

Press the [M.JOG] button.



- Track Select is available only during playing of the built-in CD player.
- Track Select cannot be performed during Random play or scan play.

Menu Operation

Menu System

Set up the following functions;

Display	Setting	Setting overview	Source
"SECURITY SET"	Refer to page 12	Sets security code	SB
"CLOCK ADJUST"	Refer to page 12	Sets the clock.	SB
"SYNC"	ON*/OFF	Synchronizing the RDS station time data and this unit's clock.	SB
"DISPLAY"	ON*/OFF	Turns off the display when no operation is performed.	—
"DIMMER"* ¹	AUTO*/OFF	Dims the display in conjunction with the light switch of the vehicle.	SB
"DIMMER"* ²	ON/OFF*	Adjusts the brightness of the display according to the surrounding illumination.	—
"DOT LINE"	ON*/OFF	Specifies whether to display the red dotted line on the display.	SB
"SWPRE"	REAR*/SUB-W	Sets the preout output.	SB
"ZONE2"* ¹	REAR*/FRONT	Specifies the destination of AUX input sound when the Dual Zone function is turned on.	SB
"SUPREME"	ON*/OFF	Turns ON/OFF the Supreme function.	AF
"NEWS"	OFF* — 90M	Turns ON/OFF the News Bulletin Automatic Reception function and sets the news bulletin interrupt disabled time.	—
"LOCAL S"	ON/OFF*	Only stations whose reception is good are searched in auto seek tuning.	FM
"SEEK"	AUTO1*/AUTO2/ MANUAL	Selects the tuning mode of the radio.	TUN
"AF"	ON*/OFF	When station reception is poor, automatically switches to the station that is broadcasting the same program over the same RDS network.	SB
"REGIONAL"	ON*/OFF	Sets whether to switch to the station only in the specific region using the "AF" control.	SB
"ATPS"	ON*/OFF	When traffic information station reception is poor, automatically searches for a station that can be received better.	SB
"MONO"	ON/OFF*	Receives a stereo broadcast in the mono mode.	FM
"NAME SET"	Refer to page 13	Sets the display when switched to AUX source.	AUX

Display	Setting	Setting overview	Source
"RUSSIAN"* ³	ON*/OFF	Selects Russian as the display language.	SB
"SCROLL"	AUTO/ MANUAL*	Scrolls the screen once when the displayed text changes.	—
"AUX"	OFF/ON1*/ ON2	Sets whether to display AUX during source selection.	SB
"POWER OFF"	--- — 20M* — 60M	Turns off the power when the preset time has lapsed in the Standby mode.	SB
"CD READ"	1*/2	Sets the CD read mode.	SB
"DEMO MODE"	Refer to page 13	Specifies whether to enable demonstration.	—

* Factory setting

¹ Function of KDC-W5641U/W5541U/W5141U/W5041U.

² Function of KDC-W4141/W4041.

³ Function of KDC-W5641U/W5141U/W4141.

Displayed item is depending on currently selected source. The mark in Source column shows the source to which the item is displayed.

SB : Can be set in other than standby state.

SB : Can be set in standby state.

AF : Can be set while Audio file source of CD/USB (excluding iPod).

TUN : Can be set while Tuner source.

FM : Can be set during FM reception.

AUX : Can be set while accessing AUX source.

— : Can be set during all sources.

1 Enter Menu mode

Press the [M.JOG] button for at least 1 second.

"MENU" is displayed.

2 Select the menu item

Push the Control knob towards up or down.

3 Set the menu item

Push the Control knob towards right or left.

4 Exit Menu mode

Press the [M.JOG] button.



- Refer to the respective page for information on how to set the items with reference page number.
- "ZONE2" is displayed when "ZONE2" in <Audio Setup> (page 6) is set to "ON".
- Refer to the <Appendix> (page 16) for the details of the menu items.

Menu Operation

Security Code

When Security Code is set, possibility of theft is reduced because input of Security Code is prompted to turn on the unit once it is turned off.



- When you activate the Security Code function, it cannot be released.
Note, your Security Code is the 4 digit number entered in your "Car Audio Passport" in this package.

1 Select Security Code item during Menu mode

Select the "SECURITY SET" display.
For how to select menu items, refer to <Menu System>(page 11).

2 Enter Security Code mode

Press the Control knob for at least 1 second.
When "ENTER" is displayed, "CODE" is also displayed.

3 Select the digits to enter

Push the Control knob towards right or left.

4 Select the Security Code numbers

Push the Control knob towards up or down.

5 Repeat steps 3 and 4, and complete the Security Code.

6 Confirm the Security Code

Press the Control knob for at least 3 seconds.
When "RE-ENTER" is displayed, "CODE" is also displayed.

7 Do the step 3 through 6 step operation, and reenter the security code.

"APPROVED" is displayed.
The Security Code function activates.



- If you enter a Code different from your Security Code, you have to start over from step 3.

8 Exit Security Code mode

Press the [M.JOG] button.

Entering Security Code

The Security Code is required to use the audio unit when the unit is first used after removed from the battery power source or the Reset button is pressed.

1 Turn the power ON.

2 Do the step 3 through 6 step operation, and reenter the security code.

"APPROVED" is displayed.



- If an incorrect code is entered, "WAITING" is displayed,

and the input prohibition periods shown in the table below is generated.

After the input prohibition time lapses, "CODE" is displayed, and you can reenter the code.

Number of times the incorrect code was input	Input prohibited time
1	—
2	5 minutes
3	1 hour
4	24 hours

Manual Clock Adjustment

1 Select Clock Adjustment item during Menu mode

Select the "CLOCK ADJUST" display.
For how to select menu items, refer to <Menu System>(page 11).

2 Enter Clock Adjust mode

Press the Control knob for at least 1 second.
The clock display blinks.

3 Adjust the time

Push the control knob towards up or down to adjust the hours and right or left to adjust the minutes.

4 Exit Clock adjustment mode

Press the [M.JOG] button.



- You can do this adjustment when the "SYNC" is set as "OFF".

Auxiliary Input Display Setting

Selects the display below when changing to Auxiliary input source;

- "AUX"
- "DVD"
- "PORTABLE"
- "GAME"
- "VIDEO"
- "TV"

1 Select Auxiliary input display setting item during Menu mode

Select the "NAME SET" display.

For how to select menu items, refer to <Menu System>(page 11).

2 Enter Auxiliary input display setting mode Press the Control knob for at least 1 second.

The presently selected Auxiliary input display is displayed.

3 Select the Auxiliary input display Push the Control knob towards right or left.

4 Exit Auxiliary input display setting mode Press the [M.JOG] button.



- When operation stops for 10 seconds, the name at that time is registered, and the Auxiliary input display setting mode closes.
- The Auxiliary input display can be set only when the built-in auxiliary input or the auxiliary input of optional KCA-S220A is used. On the KCA-S220A, "AUX EXT" is displayed by default.

Demonstration mode Setting

Turning the demonstration mode ON/OFF.

1 Select Demonstration item during Menu mode

Select the "DEMO MODE" display.

For how to select menu items, refer to <Menu System>(page 11).

2 Set the Demonstration mode Press the Control knob for at least 2 second.

Pressing this button for 2 seconds or longer toggles the setting between "ON" and "OFF".

3 Exit Demonstration mode Press the [M.JOG] button.

Basic Operations of remote control

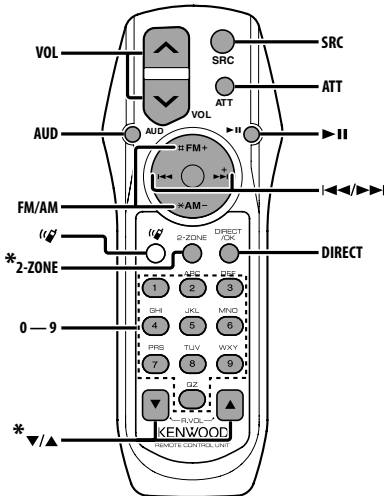

*KDC-W5641U/W5141U only

General control

Volume control [VOL]

Source select [SRC]

Volume reduce [ATT]

When the button is pressed again, the volume returns to the previous level. When the volume is reduced, the "ATT" indicator flashes.

In Audio control

Audio item select [AUD]

Adjusts the Audio item [VOL]



- Refer to <Audio Control> (page 6) for the operation method, such as the procedures for Audio control and others operations.

Dual Zone control

Dual zone system on and off [2-ZONE]

Rear channel volume control [▲]/[▼]

In Tuner source

Band select [FM]/[AM]

Station select [◀]/[▶]

Recall preset stations [1] — [6]

In CD/USB source

Music select [◀]/[▶]

Folder/Disc select [FM]/[AM]

Pause/Play [II]



About [Bluetooth]

This button is used when Bluetooth HANDS FREE BOX is connected. For more information, refer to the instruction manual of Bluetooth HANDS FREE BOX.



- Do not set the remote control in hot places such as on the dashboard.

Loading and Replacing battery

Use two "AA"/"R6"-size batteries.

Slide the cover while pressing downwards to remove it as illustrated.

Insert the batteries with the + and - poles aligned properly, following the illustration inside the case.

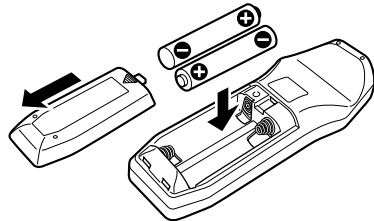

Appendix

About Audio file

- **Playable Audio file**
AAC-LC (.m4a), MP3 (.mp3), WMA (.wma)
- **Playable disc media**
CD-R/RW/ROM
- **Playable disc file format**
ISO 9660 Level 1/2, Joliet, Romeo, Long file name.
- **USB device Playable Model**
KDC-W5641U, KDC-W5541U, KDC-W5141U, KDC-W5041U
- **Playable USB device**
USB mass storage class
- **Playable USB device file system**
FAT16, FAT32
- **iPod Playable Model**
KDC-W5641U, KDC-W5541U

Although the audio files are complied with the standards listed above, the play maybe impossible depending on the types or conditions of media or device.

• Playing order of the Audio file

In the example of folder/file tree shown below, the files are played in the order from ① to ⑩.

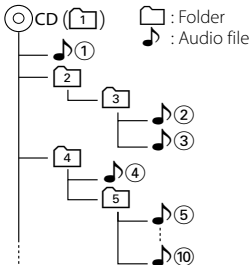

An online manual about audio files is put on the site, www.kenwood.com/audiofile/. On this online manual, detailed information and notes which are not written in this manual are provided. Make sure to read through the online manual as well.



- In this manual, the word "USB device" is used for flash memories and digital audio players which have USB terminals.
- The word "iPod" appearing in this manual indicates the iPod connected with the iPod connection cable (optional accessory). The iPod connected with the iPod connection cable can be controlled from this unit. iPods that can be connected with the iPod connection cable are the iPod nano, Fifth Generation iPod, iPod classic, and iPod touch. Other iPods cannot be connected.

About USB device

- If you start playback after connecting the iPod, the music that has been played by the iPod is played first.
In this case, "RESUMING" is displayed without displaying a folder name, etc. Changing the browse item will display a correct title, etc.
- When the iPod is connected to this unit, "KENWOOD" or "✓" is displayed on the iPod to indicate that you cannot operate the iPod.
- When the USB device is connected to this unit, it can be charged up provided that this unit is powered.
- Install the USB device in the place where it will not prevent you from driving your vehicle properly.
- You cannot connect a USB device via a USB hub and Multi Card Reader.
- Take backups of the audio files used with this unit. The files can be erased depending on the operating conditions of the USB device.
We shall have no compensation for any damage arising out of erasure of the stored data.
- No USB device comes with this unit. You need to purchase a commercially available USB device.
- When connecting the USB device, usage of the CA-U1EX (option) is recommended.
Normal playback is not guaranteed when a cable other than the USB compatible cable is used. Connecting a cable whose total length is longer than 5 m can result in abnormal playback.

Appendix

Menu Glossary

• SWPRE (Switching Preout)

Switches the preout between rear output ("REAR") and subwoofer output ("SUB-W").

• SUPREME

Technology to extrapolate and supplement with proprietary algorithm, the high-frequency range that is cut off when encoding at low bit rate (less than 128Kbps, Sampling frequency is 44.1kHz).

Supplementing is optimized by compression format (AAC, MP3 or WMA) and processed according to bit rate.

The effect is negligible with music that is encoded at high bit rate, variable bit rate or has minimal high frequency range.

• CD READ

Sets the method for reading CD.

When unable to play special format CD, set this function to "2" to force playing. Note that some music CD may be unplayable even when set to "2". In addition, audio files cannot be played when set to "2". Normally, keep this set to "1".

1 : Automatically distinguishes between audio file disc and music CD when playing disc.

2 : Forces playing as music CD.

• AUX

When this is set to ON, AUX source can be selected.

ON1: Outputs the sound of external unit connected to the AUX terminal when switched to AUX source.

ON2: Activates the attenuator function when switched to AUX source.

Turn off the attenuator function when listening to output from external unit. This prevents the noise when no external unit is connected to AUX terminal.

OFF: Disables the selection of AUX source.

Set to OFF when not using the AUX terminal.

• NEWS (News Bulletin with Timeout Setting)

Automatically receives news bulletin when it starts. Set the time during which interrupt is to be disabled after start of another news bulletin.

Changing "NEWS 00M" to "NEWS 90M" turns this function ON. When this function is ON, the "NEWS" indicator is ON.

If news bulletin starts when this function is ON, "TRAFFIC" is displayed and news is received. If "20M" is has been set, reception of another news bulletin will not start for 20 minutes.

The news bulletin volume is the same level that was set for Traffic Information.

• SEEK (Tuning mode select)

Select a tuning mode of the radio.

Tuning mode	Display	Operation
Auto seek	"AUTO1"	Automatic search for a station.
Preset station seek	"AUTO2"	Search in order of the stations in the Preset memory.
Manual	"MANUAL"	Normal manual tuning control.

• AF (Alternative Frequency)

When the reception is poor, automatically alternate to another frequency broadcasting the same program in the same RDS network with better reception.

• RUSSIAN (Russian language setting)

When this is set to ON, the following character strings are displayed in Russian:

Folder name/ File name/ Song title/ Artist name/
Album name/ KCA-BT100 (optional accessory)

А	Б	В	Г	Д	Е	Ж	З	И	Й	К	Л	М	Н	О	П
Р	С	Т	У	Ф	Х	Ц	Ч	Ш	Щ	Ъ	Ы	Ь	Э	Ю	Я

Р	С	Т	У	Ф	Х	Ц	Ч	Ш	Щ	Ъ	Ы	Ь	Э	Ю	Я
---	---	---	---	---	---	---	---	---	---	---	---	---	---	---	---

• POWER OFF (Power OFF Timer)

Setting the timer to turn this unit's power OFF automatically when Standby mode continues. Using this setting can save the vehicle's battery power.

-- -: Power OFF Timer function is OFF.

20M: Turns the power OFF after 20 minutes. (Factory setting)

40M: Turns the power OFF after 40 minutes.

60M: Turns the power OFF after 60 minutes.

• ZONE2 (Dual Zone)

Set the destination (front speaker "FRONT" or rear speaker "REAR") of the sub source (AUX IN) when the Dual Zone function is turned on.

• DISPLAY

If this unit is not operated at least 5 seconds with "OFF" selected, the display turns off. During a setup mode, the display will not turn off even if 5 seconds lapse.

For operating KCA-BT100

To control KCA-BT100, operate as follows;
To make setting for <Selecting the Dialing Mode>, select <Menu System> (page 11). Pressing the  button for at least 1 second after selecting the "DIALING MODE" item allows you to enter the dialing method selection mode. To exit from dialing method selection mode, press [M.JOG] button.

To make <Disconnecting a Call>, <Clearing the Disconnection Message>, and <Rejecting an Incoming call>, press [AUTO] button for at least 1 second.

Moreover, some displays are different from the description of KCA-BT100 Instruction Manual.

Displays of KCA-BT100 Instruction Manual	Actual displays on this unit
"DISCONCT"	"HF DISCONCT"
"CONNECT"	"HF CONNECT"
"PHN-DEL"	"DEVICE DEL"
"P-STATUS"	"DVC STATUS"
"BT-CON Y"	"HF CONNECT Y"
"T-CON N"	"HF CONNECT N"

BT : Displays the bluetooth connection status.
This indicator turns on when a cell-phone is connected to this unit.

 : Displays the signal strength of cell-phone.

 : Displays the battery level of cell-phone.



This Product is not installed by the manufacturer of a vehicle on the production line, nor by the professional importer of a vehicle into an EU Member State.

Information on Disposal of Old Electrical and Electronic Equipment (applicable for EU countries that have adopted separate waste collection systems)



Products with the symbol (crossed-out wheeled bin) cannot be disposed as household waste.

Old electrical and electronic equipment should be recycled at a facility capable of handling these items and their waste byproducts. Contact your local authority for details in locating a recycle facility nearest to you. Proper recycling and waste disposal will help conserve resources whilst preventing detrimental effects on our health and the environment.

The marking of products using lasers (Except for some areas)

**CLASS 1
LASER PRODUCT**

The label is attached to the chassis/case and says that the component uses laser beams that have been classified as Class 1. It means that the unit is utilizing laser beams that are of a weaker class. There is no danger of hazardous radiation outside the unit.



Declaration of Conformity with regard to the EMC Directive 2004/108/EC

Manufacturer:

Kenwood Corporation
2967-3 Ishikawa-machi, Hachioji-shi, Tokyo, 192-8525 Japan

EU Representative's:

Kenwood Electronics Europe BV
Amsterdamseweg 37, 1422 AC UITHOORN, The Netherlands

Accessories/ Installation Procedure

Accessories

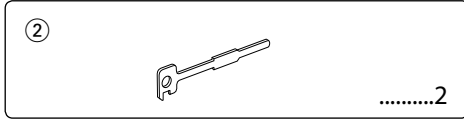
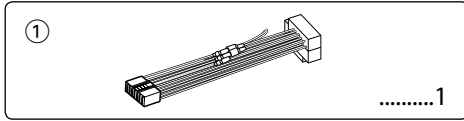

Installation Procedure

1. To prevent short circuits, remove the key from the ignition and disconnect the ⊖ terminal of the battery.
2. Make the proper input and output wire connections for each unit.
3. Connect the wire on the wiring harness.
4. Take Connector B on the wiring harness and connect it to the speaker connector in your vehicle.
5. Take Connector A on the wiring harness and connect it to the external power connector on your vehicle.
6. Connect the wiring harness connector to the unit.
7. Install the unit in your car.
8. Reconnect the ⊖ terminal of the battery.
9. Press the reset button.



- Mounting and wiring this product requires skills and experience. For safety's sake, leave the mounting and wiring work to professionals.
- Make sure to ground the unit to a negative 12V DC power supply.
- Do not install the unit in a spot exposed to direct sunlight or excessive heat or humidity. Also avoid places with too much dust or the possibility of water splashing.
- Do not use your own screws. Use only the screws provided. If you use the wrong screws, you could damage the unit.
- If the power is not turned ON ("PROTECT" is displayed), the speaker wire may have a short-circuit or touched the chassis of the vehicle and the protection function may have been activated. Therefore, the speaker wire should be checked.
- Make sure that all wire connections are securely made by inserting jacks until they lock completely.
- If your vehicle's ignition does not have an ACC position, or if the ignition wire is connected to a power source with constant voltage such as a battery wire, the power will not be linked with the ignition (i.e., it will not turn on and off along with the ignition). If you want to link the unit's power

with the ignition, connect the ignition wire to a power source that can be turned on and off with the ignition key.

- Use a commercially available conversion connector if the connector does not fit in the vehicle connector.
- Insulate unconnected wires with vinyl tape or other similar material. To prevent a short circuit, do not remove the caps on the ends of the unconnected wires or the terminals.
- If the console has a lid, make sure to install the unit so that the faceplate will not hit the lid when closing and opening.
- If the fuse blows, first make sure the wires aren't touching to cause a short circuit, then replace the old fuse with one with the same rating.
- Connect the speaker wires correctly to the terminals to which they correspond. The unit may be damaged or fail to work if you share the ⊖ wires or ground them to any metal part in the car.
- After the unit is installed, check whether the brake lamps, blinkers, wipers, etc. on the car are working properly.
- Mount the unit so that the mounting angle is 30° or less.

About CD players/disc changers connected to this unit

Kenwood disc changers/ CD players released in 1998 or later can be connected to this unit. Refer to the catalog or consult your Kenwood dealer for connectable models of disc changers/ CD players. Note that any Kenwood disc changers/ CD players released in 1997 or earlier and disc changers made by other makers cannot be connected to this unit. Connecting unsupported disc changers/CD players to this unit may result in damage. Set the "O-N" Switch to the "N" position for the applicable Kenwood disc changers/ CD players. The functions you can use and the information that can be displayed may differ depending on the models being connected.

Connecting Wires to Terminals

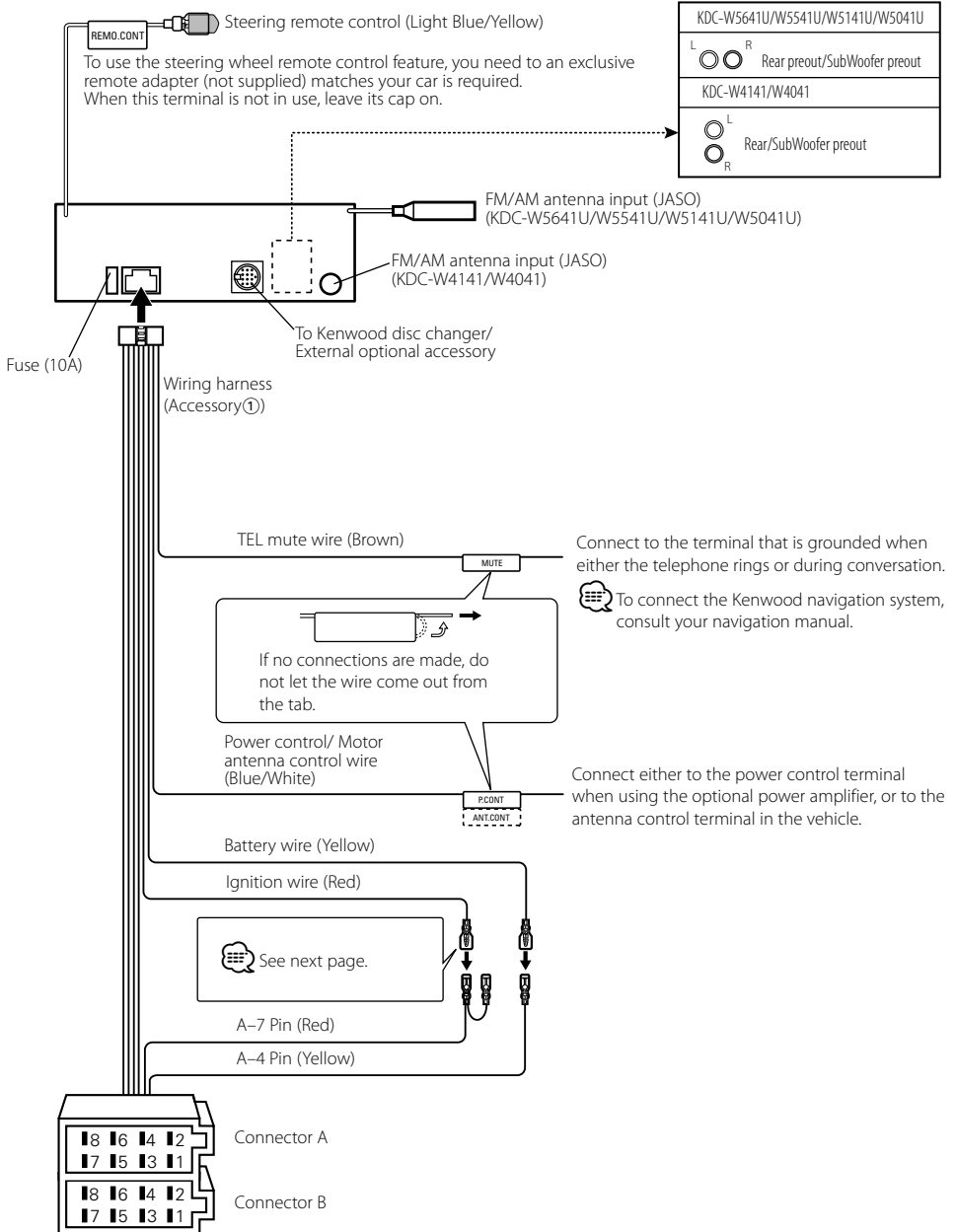

Connecting Wires to Terminals

Connector Function Guide

Pin Numbers for ISO Connectors	Cable Colour	Functions
External Power Connector		
A-4	Yellow	Battery
A-5	Blue/White	Power Control
A-6	Orange/White	Dimmer*
A-7	Red	Ignition (ACC)
A-8	Black	Earth (Ground) Connection
Speaker Connector		
B-1	Purple	Rear Right (+)
B-2	Purple/Black	Rear Right (-)
B-3	Gray	Front Right (+)
B-4	Gray/Black	Front Right (-)
B-5	White	Front Left (+)
B-6	White/Black	Front Left (-)
B-7	Green	Rear Left (+)
B-8	Green/Black	Rear Left (-)

*Function of KDC-W5641U/W5541U/W5141U/W5041U.

⚠ WARNING

Connecting the ISO Connector

The pin arrangement for the ISO connectors depends on the type of vehicle you drive. Make sure to make the proper connections to prevent damage to the unit.

The default connection for the wiring harness is described in [1] below. If the ISO connector pins are set as described in [2] or [3], make the connection as illustrated.

Please be sure to reconnect the cable as shown [2] below to install this unit to the **Volkswagen** vehicles etc.

[1] (Default setting) The A-7 pin (red) of the vehicle's ISO connector is linked with the ignition, and the A-4 pin (yellow) is connected to the constant power supply.

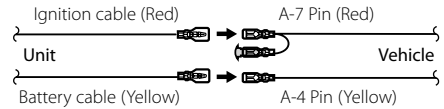

[2] The A-7 pin (red) of the vehicle's ISO connector is connected to the constant power supply, and the A-4 pin (yellow) is linked to the ignition.

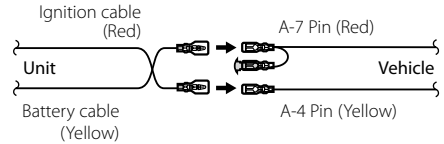

[3] The A-4 pin (yellow) of the vehicle's ISO connector is not connected to anything, while the A-7 pin (red) is connected to the constant power supply (or both the A-7 (red) and A-4 (yellow) pins are connected to the constant power supply).

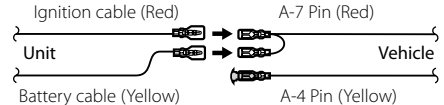

- When the connection is made as in [3] above, the unit's power will not be linked to the ignition key. For that reason, always make sure to turn off the unit's power when the ignition is turned off.

To link the unit's power to the ignition, connect the ignition cable (ACC...red) to a power source that can be turned on and off with the ignition key.

Installation/Removing the Unit

Installation

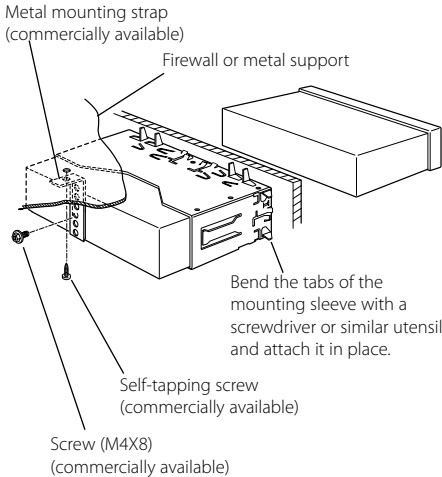

- Make sure that the unit is installed securely in place. If the unit is unstable, it may malfunction (for example, the sound may skip).

Removing the hard rubber frame

- 1 Engage the catch pins on the removal tool and remove the two locks on the upper level. Upper the frame and pull it forward as shown in the figure.

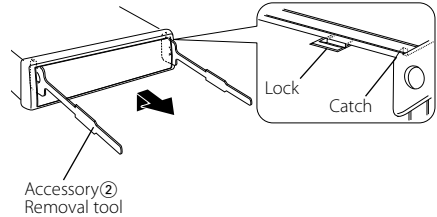

- 2 When the upper level is removed, remove the lower two locations.



- The frame can be removed from the bottom side in the same manner.

Removing the Unit

- 1 Refer to the section <Removing the hard rubber frame> and then remove the hard rubber frame.
- 2 Remove the screw (M4 x 8) on the back panel.
- 3 Insert the two removal tools deeply into the slots on each side, as shown.
- 4 Lower the removal tool toward the bottom, and pull out the unit halfway while pressing towards the inside.

Screw (M4X8)
(commercially available)

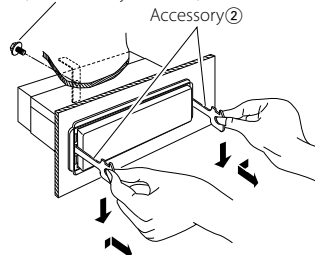

- Be careful to avoid injury from the catch pins on the removal tool.
- 5 Pull the unit all the way out with your hands, being careful not to drop it.

Troubleshooting Guide

Some functions of this unit may be disabled by some settings made on this unit.

- !** • **Cannot set up the subwoofer.**
- **Cannot set up the High Pass Filter.**
- **Cannot set up the Fader.**
- **No Audio control effect on AUX.**
 - ▶ Preout is not set to subwoofer. ⓘ "SWPRE" of <Menu System> (page 11)
 - ▶ "Subwoofer output" of <Basic Operation> (page 4) is not set to On.
 - ▶ The Dual zone function is enabled. ⓘ <Audio Setup> (page 6)

- !** • **Cannot set up the subwoofer phase.**
 - ▶ The Low Pass Filter is set to Through. ⓘ <Audio Setup> (page 6)

- !** • **Cannot select the output destination of the subsource in the Dual zone.**
- **Cannot adjust the volume of the rear speakers.**
 - ▶ The Dual zone function is disabled. ⓘ <Audio Setup> (page 6)

- !** • **Cannot register a security code.**
- **Cannot set up Display Illumination Control.**
 - ▶ <Demonstration mode Setting> (page 13) is not turned off.

- !** • **Cannot set up the Power-off timer.**
 - ▶ <Security Code> (page 12) is not set.

What might seem to be a malfunction in your unit may just be the result of slight misoperation or miswiring. Before calling service, first check the following table for possible problems.

Tuner source

- ? Radio reception is poor.**
 - ✓ The car antenna is not extended.
 - ⓘ Pull the antenna out all the way.

Disc source

- ? The specified disc does not play, but another one plays instead.**
 - ✓ The specified CD is quite dirty.
 - ⓘ Clean the CD.
 - ✓ The disc is loaded in a different slot from that specified.
 - ⓘ Eject the disc magazine and check the number for the specified disc.
 - ✓ The disc is severely scratched.
 - ⓘ Try another disc instead.

Audio file source

- ? The sound skips when an Audio file is being played.**
 - ✓ The media is scratched or dirty.
 - ⓘ Clean the media, referring to the CD cleaning of the section on <Handling CDs> (page 3).
 - ✓ The recording condition is bad.
 - ⓘ Record the media again or use another media.

The messages shown below display your systems condition.

TOC ERROR:	<ul style="list-style-type: none">• No disc has been loaded in the disc magazine.• The CD is quite dirty. The CD is upside-down. The CD is scratched a lot.	USB ERROR/USB (Blink):	<p>Some trouble may have occurred to the connected USB device.</p> <ul style="list-style-type: none">↻ Remove the USB device, then cycle the power switch to ON. If the same display is repeated, use another USB device.
E-05:	The disc is unreadable.	iPod ERROR:	<p>Connection to the iPod has failed.</p> <ul style="list-style-type: none">↻ Check that the connected iPod is an iPod that is supported. See <About Audio file> (page 15) for information on supported iPods.↻ Remove the USB device and then reconnect it.↻ Confirm that the software for the iPod is the latest version.
E-77:	The unit is malfunctioning for some reason. <ul style="list-style-type: none">↻ Press the reset button on the unit. If the "E-77" code does not disappear, consult your nearest service center.	USB REMOVE:	The Remove mode has been selected for the USB device/iPod. You can remove the USB device/iPod safely.
E-99:	Something is wrong with the disc magazine. Or the unit is malfunctioning for some reason. <ul style="list-style-type: none">↻ Check the disc magazine. And then press the reset button on the unit. If the "E-99" code does not disappear, consult your nearest service center.		
IN (Blink):	The CD player section is not operating properly. <ul style="list-style-type: none">↻ Reinsert the CD. If the CD cannot be ejected or the display continues to flash even when the CD has been properly reinserted, please switch off the power and consult your nearest service center.		
PROTECT:	The speaker wire has a short-circuit or touches the chassis of the vehicle, and then the protection function is activated. <ul style="list-style-type: none">↻ Wire or insulate the speaker cable properly and press the reset button. If the "PROTECT" code does not disappear, consult your nearest service center.		
NA FILE:	An Audio file is played with a format that this unit can't support.		
COPY PRO:	A copy-protected file is played.		
READ ERROR:	The file system of the connected USB device is broken. <ul style="list-style-type: none">↻ Copy the files and folders for the USB device again. If the error message is still displayed, initialize the USB device or use other USB devices.		
NO DEVICE:	The USB device is selected as a source although no USB device is connected. <ul style="list-style-type: none">↻ Change the source to any source other than USB. Connect an USB device, and change the source to USB again.		
N/A DEVICE:	An unsupported USB device is connected. <ul style="list-style-type: none">↻ Remove the USB device without entering the remove mode.		
NO MUSIC DATA/E-15:	<ul style="list-style-type: none">• The connected USB device contains no playable audio file.• Media was played that doesn't have data recorded that the unit can play.		

Specifications

FM tuner section

- Frequency range (50 kHz space)
 - : 87.5 MHz – 108.0 MHz
- Usable sensitivity (S/N = 26dB)
 - : 0.7 μ V/75 Ω
- Quieting Sensitivity (S/N = 46dB)
 - : 1.6 μ V/75 Ω
- Frequency response (\pm 3.0 dB)
 - : 30 Hz – 15 kHz
- Signal to Noise ratio (MONO)
 - : 65 dB
- Selectivity (DIN) (\pm 400 kHz)
 - : \geq 80 dB
- Stereo separation (1 kHz)
 - : 35 dB

MW tuner section

- Frequency range (9 kHz space)
 - : 531 kHz – 1611 kHz
- Usable sensitivity (S/N = 20dB)
 - : 25 μ V

LW tuner section

- Frequency range
 - : 153 kHz – 281 kHz
- Usable sensitivity (S/N = 20dB)
 - : 45 μ V

CD player section

- Laser diode
 - : GaAlAs
- Digital filter (D/A)
 - : 8 Times Over Sampling
- D/A Converter
 - : 24 Bit
- Spindle speed
 - : 500 – 200 rpm (CLV)
- Wow & Flutter
 - : Below Measurable Limit
- Frequency response (\pm 1 dB)
 - : 10 Hz – 20 kHz
- Total harmonic distortion (1 kHz)
 - : 0.008 %
- Signal to Noise ratio (1 kHz)
 - : 105 dB
- Dynamic range
 - : 93 dB
- MP3 decode
 - : Compliant with MPEG-1/2 Audio Layer-3
- WMA decode
 - : Compliant with Windows Media Audio
- AAC decode
 - : AAC-LC ".m4a" files

USB Interface (KDC-W5641U/W5541U/W5141U/W5041U)

- USB Standard
 - : USB1.1/ 2.0
- Maximum Supply current
 - : 500 mA
- File System
 - : FAT16/ 32
- MP3 decode
 - : Compliant with MPEG-1/2 Audio Layer-3
- WMA decode
 - : Compliant with Windows Media Audio
- AAC decode
 - : AAC-LC ".m4a" files

Audio section

- Maximum output power
 - : 50 W x 4
- Full Bandwidth Power (at less than 1% THD)
 - : 30 W x 4
- Speaker Impedance
 - : 4 – 8 Ω
- Tone action
 - Bass : 100 Hz \pm 8 dB
 - Middle : 1 kHz \pm 8 dB
 - Treble : 10 kHz \pm 8 dB
- Preout level / Load (CD)
 - : 2500 mV/10 k Ω
- Preout impedance
 - : \leq 600 Ω

Auxiliary input

- Frequency response (\pm 1 dB)
 - : 20 Hz – 20 kHz
- Input Maximum Voltage
 - : 1200 mV
- Input Impedance
 - : 10 k Ω

General

- Operating voltage (11 – 16V allowable)
 - : 14.4 V
- Current consumption
 - : 10 A
- Installation Size (W x H x D)
 - : 182 x 53 x 155 mm
- Weight
 - : 1.40 kg

Specifications subject to change without notice.