

23/16-339

Canon T60



INSTRUCTIONS



Precautions

- 1) This camera is not resistant to water, and cannot be used underwater or outdoors if raining or snowing. If accidentally dropped in water, contact an authorized Canon service facility as quickly as possible. Remove water droplets from the camera with a clean dry cloth. If exposed to salt spray, clean it thoroughly afterward with a clean, damp, well-rung cloth.
- 2) Store the camera in a cool, dry, dust-free place. Be sure to keep the camera out of direct sunlight, and away from "hot spots" such as the trunk or rear window shelf of a car. Avoid places where moth balls are used, and in excessive humidity, use a desiccant.
- 3) Do not attempt to disassemble the camera yourself. Always take it to an authorized Canon service facility for repair.
- 4) Use a blower brush to remove dust and sand from the lens and inside the camera. Do not apply any fluids to the lens or body. Take it to a Canon service facility for more cleaning if necessary.
- 5) Film passing through x-ray examinations at airports may be exposed and ruined even when loaded in the camera. Request a hand-checked inspection to avoid damage.
- 6) Color reproduction may be adversely affected if film is left in the camera for a long time. Always develop exposed film promptly.

See p. 40 for camera care.

Introduction

The Canon T60, a single-lens reflex (SLR) camera designed for first-time users, places an emphasis on providing basic SLR functions. It is equipped with simple controls and functions in a lightweight, compact body. The viewfinder provides all necessary camera setting and exposure information.

The T60 features "Aperture-priority AE" mode providing uncomplicated automatic exposure operation for beginning users, and "Manual" mode allowing full control of the camera to give the more experienced user free reign in exploring creative ideas.

Lastly, the T60 employs an FD mount which accepts lenses from Canon's large FD lens line-up used by professionals worldwide.

T60 Features

1. Aperture-priority AE and Manual exposure modes
2. FD mount accepts FD lenses
3. Lightweight, compact body for ease of handling

Please read these instructions carefully for a thorough understanding before taking pictures.

While reading this booklet, unfold the front and back flaps for easy reference to the camera's parts.



NOMENCLATURE

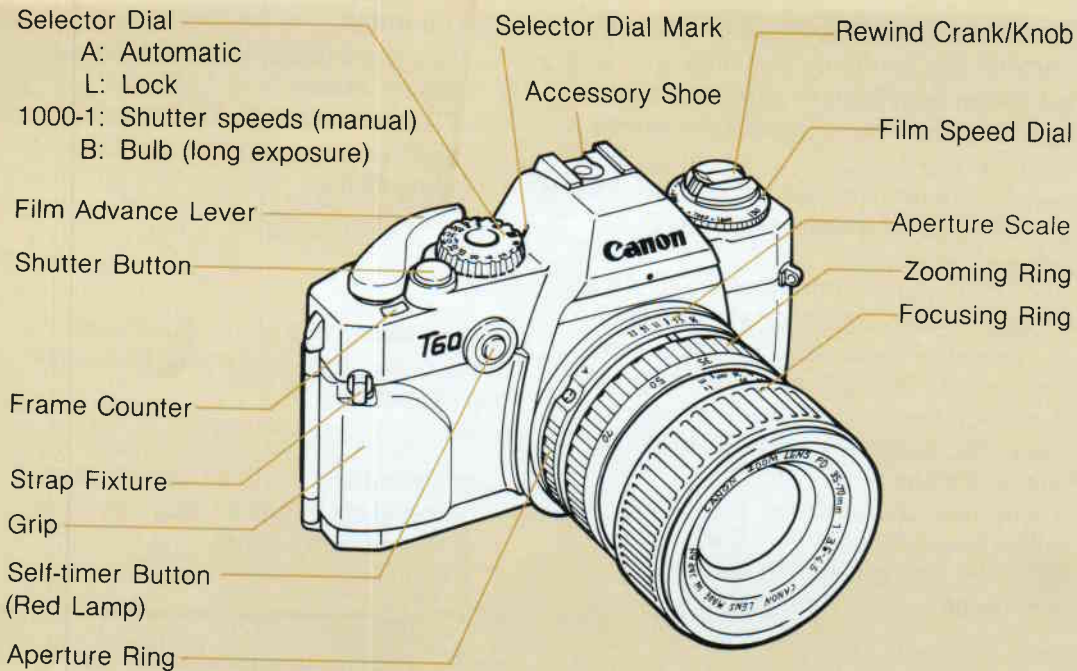

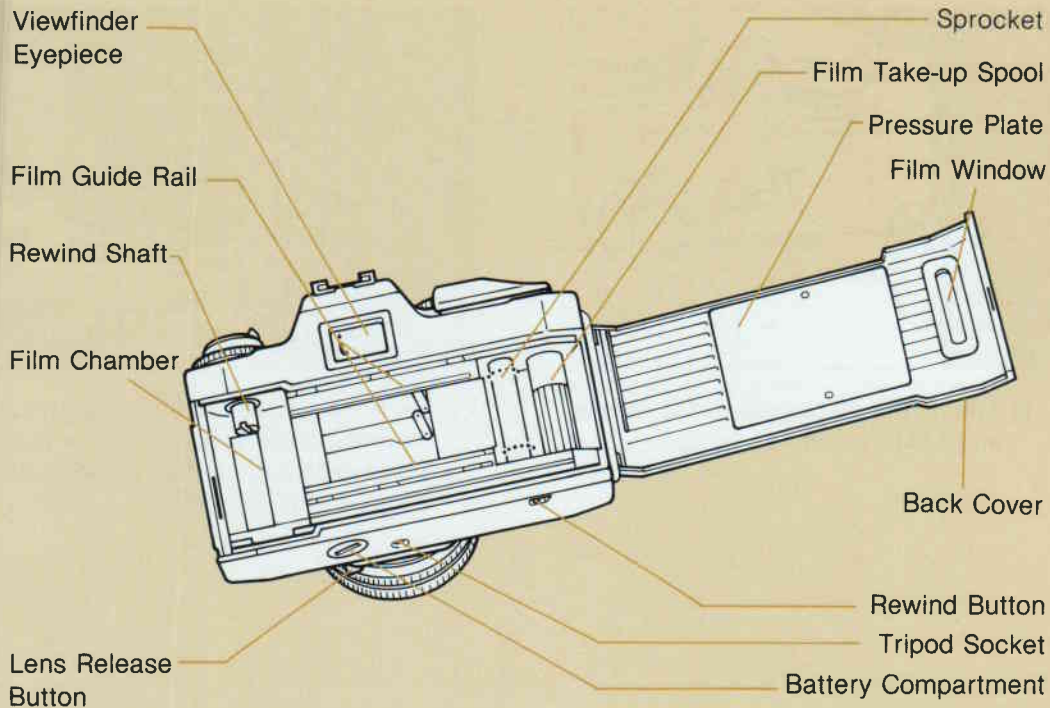

Attaching the Neckstrap

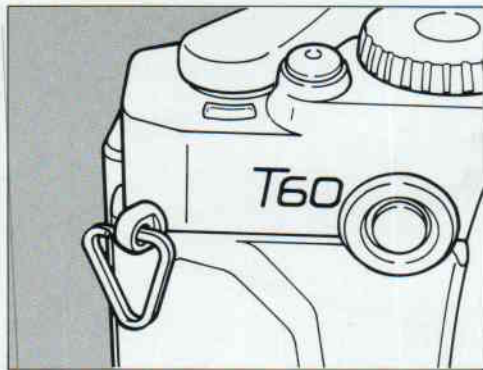

1) Attach the neckstrap rings to the strap fixtures on the camera.

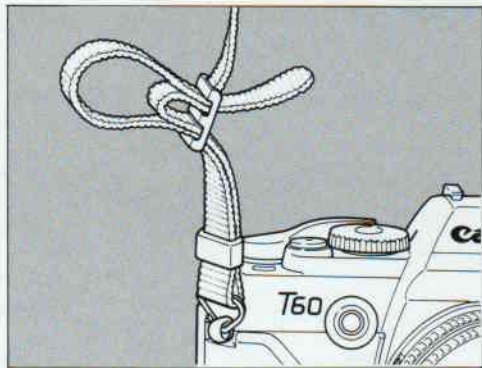

2) As shown in the illustration, attach the ends of the neckstrap to the neckstrap rings so that they come to the inside of the neckstrap.

Table of Contents

Preparations

- 1. Loading the Batteries 6
- 2. Lens Attachment 7
- 3. Checking the Batteries 8
- 4. Viewfinder Information 9
- 5. Holding the Camera 11
- 6. Focusing and Shutter
Button Action 12
- 7. Setting the Film Speed 15
- 8. Loading the Film 16

Taking Pictures

- 1. Automatic Exposure Operation . . . 20
- 2. Removing the Film 23
- 3. Manual Exposure Operation 24
- 4. Self-timer Function 28
- 5. Bulb (Long Exposure) Shooting . . 29
- 6. Using Infrared Film 31
- 7. Flash Photography 32

Appendix

- 1. Understanding Depth of Field . . . 34
- 2. Film Plane Indicator 36

Interchangeable Lenses 37

Accessories

- 1. Cases 38
- 2. Dioptic Adjustment Lenses 39

Camera Care 40

Specifications 40

Attaching the Neckstrap 43

Preparations

1. Loading the Batteries

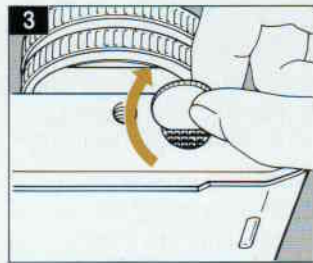
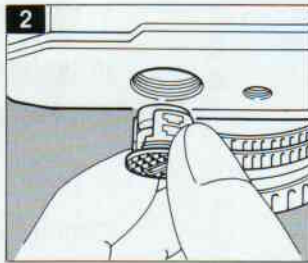
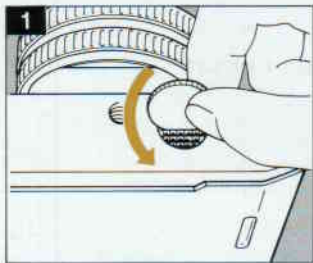

This camera uses two LR44 alkaline batteries or two SR44 silver batteries.

- 1) Remove the battery holder by turning it counterclockwise with a coin or similar object.
- 2) As shown on the diagram on the outside of the battery holder, insert two batteries into the holder with the ⊕ side of each battery facing up.
- 3) Replace the battery holder and turn it clockwise using a coin or similar object to secure it in place.

- When changing the batteries, be sure to replace both batteries with new ones of the same brand.
- Remove the batteries if the camera is not to be used for an extended period of time.

2. Lens Attachment



- 1) Remove the rear lens cap and body cap by turning counterclockwise.
- 2) Align the red dots on the lens and the camera, and then turn the lens clockwise until it stops and locks in place.
 - To remove the lens, hold the lens release button down and turn the lens counterclockwise.
- 3) Remove the lens cap.

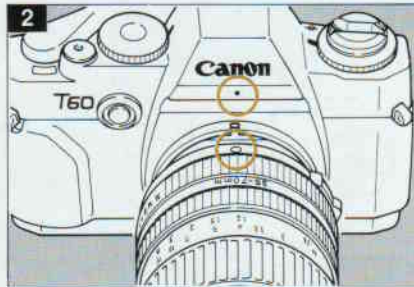

3. Checking the Batteries

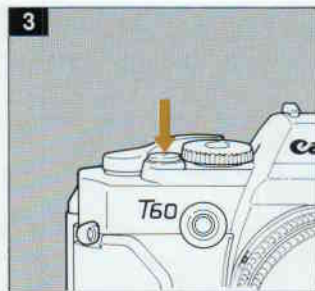

- 1) Set the selector dial to "A".
- 2) Rotate the winding lever until it stops.
- 3) While looking through the viewfinder, press the shutter button halfway.
 - If at least two of the red LEDs inside the viewfinder are lit or blinking, the batteries are okay.
 - If none of the LEDs light up, either the batteries were inserted upside down or the batteries are exhausted and need to be replaced.

- Battery life is approximately 1 year under normal use.
- When the camera is not being used, be sure to set the selector dial to "L" (Lock) to prevent unnecessary battery drain.

4. Viewfinder Information

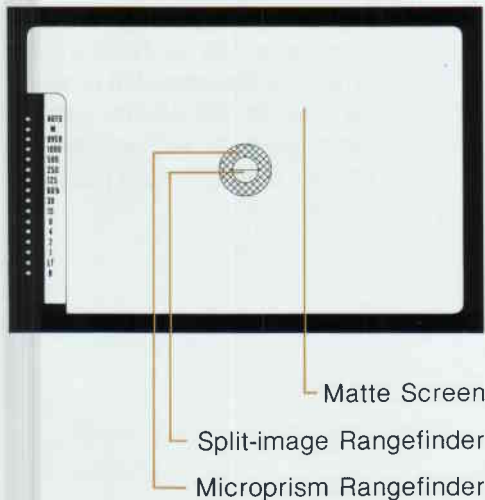

The LEDs in the viewfinder light up or blink when necessary to inform you of various exposure information. The information provided in the viewfinder is shown in the illustration at the left.

- : These LEDs light or blink to indicate camera settings and conditions.
- AUTO: This LED lights when the selector dial is set to A (automatic exposure).
- M: This LED lights when the selector dial is set to a manual exposure position (any position other than "A" or "L").
- OVER: This LED lights to warn of overexposure.

1000-1: The LED corresponding to the set shutter speed lights.

All shutter speeds are actually the reciprocal of the numerals displayed. For example, "125" indicates a shutter speed of 1/125 sec.

60 : This is the fastest shutter speed that can be used with a flash. Flash is synchronized at all shutter speeds 1/60 sec or slower.

LT: This LED lights when a Long Time shutter speed of 2-8 seconds is set.

B: This LED lights when the camera is set to Bulb mode. When the selector dial is set to "B" (Bulb), the shutter will remain open for as long as the shutter button is held pressed.

5. Holding the Camera



If the camera moves while a picture is being taken, the resulting picture may be unclear. Sharp pictures require that the camera be held very still when the shutter button is pressed. Try the following camera-holding technique to avoid disappointments.

- 1) Grasp the camera grip securely with the right hand.
- 2) Use your left hand to support both the camera body and the lens, and keep your left elbow close to your body.

- 3) Lightly hold the camera against your nose and look into the viewfinder.
- 4) With your feet spread slightly apart, place one foot in front of the other to stabilize your stance.
 - There is no absolute camera holding technique which is right for every individual. Practice holding the camera in different ways to determine which is the best technique for you. Practicing in front of a mirror is helpful.

6. Focusing and Shutter Button Action

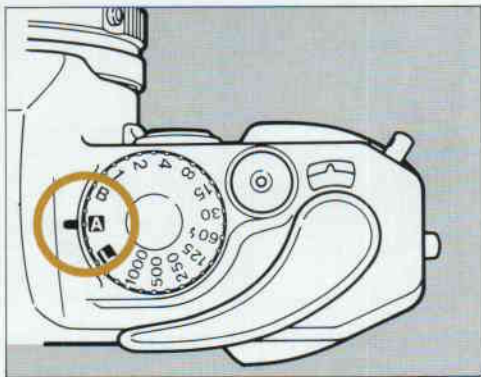

By rotating the lens' focusing ring, you can focus on objects located in any part of the viewfinder image area.

1) Set the selector dial to "A".

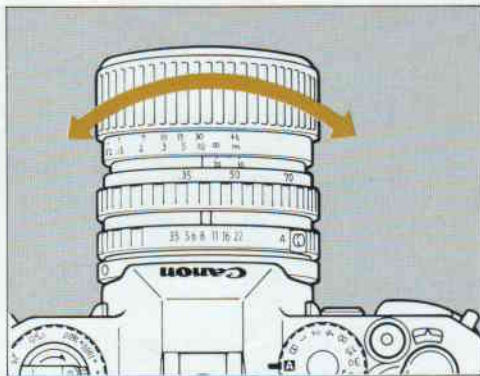

2) While looking through the viewfinder, rotate the lens' focusing ring until the viewfinder image appears sharp.

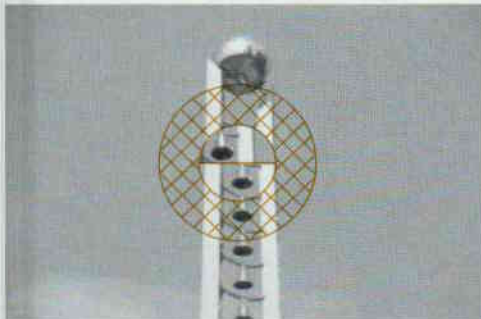

3) Check the focus. Three focusing aids are provided inside the viewfinder: a split-image rangefinder, which is the horizontal line located in the center of the viewfinder, a microprism ring, which surrounds the split-image rangefinder, and a surrounding matte screen.

① With the split-image rangefinder, you can tell the subject is in focus when the upper and lower images

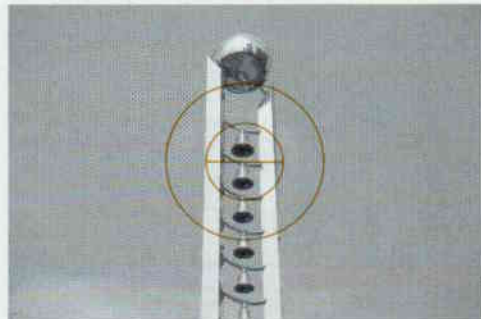

align (merge) to form a complete image.

- ② The microprism ring, which shows a broken, unclear image when the subject is out of focus, shows a clear image when in focus.
- ③ The surrounding matte screen shows a misty image when the subject is out of focus but becomes clear when in focus.

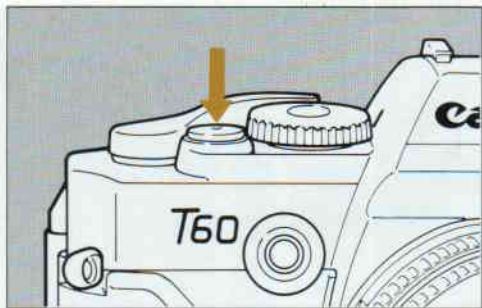

4) Press the shutter button.

- The shutter button has a 2-step pressing action. When lightly pressed halfway (to the first step), the red LEDs in the viewfinder light up to indicate the current camera status. When pressed completely (to the second step), the shutter is released and a picture is taken. In order to prevent camera shake, start with the ball of your index finger resting on the shutter button and then gently press the shutter button.

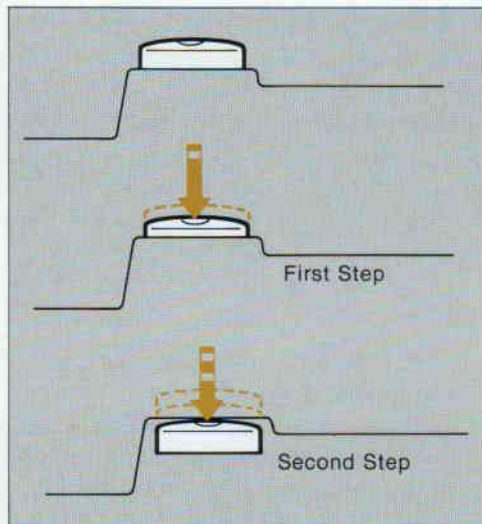

7. Setting the Film Speed

Before loading film, set the film speed on the film speed dial. The proper film speed is indicated on the film box and on the outside of the film cartridge.

1) Turn the film speed dial until the proper film speed setting is aligned with the film speed setting mark.

- The film speed dial has click stops for each setting on the scale. When setting the film speed, be sure the dial is set to the appropriate click stop position, not between click stops.

■ Available film speed settings are shown below. The points between the numbers represent the film speeds shown in parentheses ().

ISO 25 . . . 50 . . . 100 . . . 200 . . .
(32) (40) (64) (80) (125) (160) (250) (320)

400 1000 . 1600
(500) (640) (800) (1250)

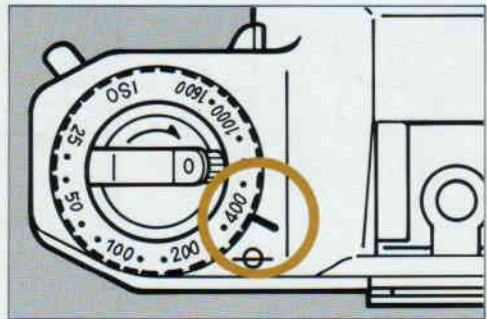

6. Loading the Film

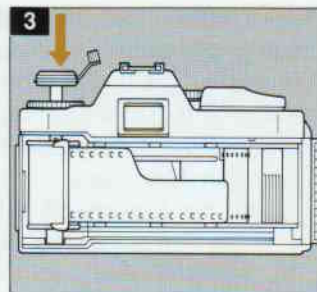
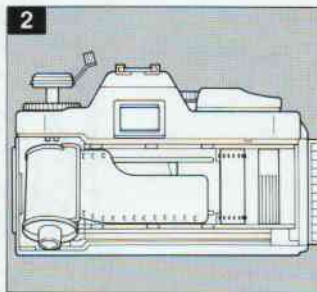
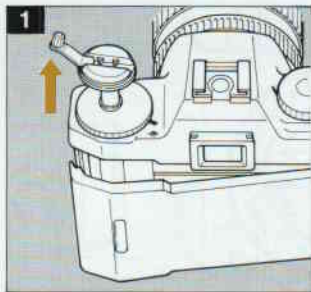

Avoid direct sunlight when loading or unloading film, and take care not to touch the shutter curtain, the film guide rails, or the pressure plate.

- 1) Pull up the rewind crank knob to open the back cover.
- 2) Insert the film cartridge into the film chamber as shown in the illustration.

- 3) Lower the rewind crank knob to its original position to secure the film cartridge in place.
 - If the rewind crank knob cannot be lowered all the way, turn the knob slightly while gently pressing down until the rewind shaft slides easily into the cartridge.

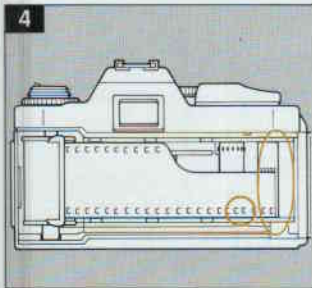

- 4) Pull the film leader across and insert the tip of the film leader into one of the slots in the take-up spool.
- 5) Slowly wind the film advance lever to advance the film once, taking care that the film perforations engage with the sprockets.

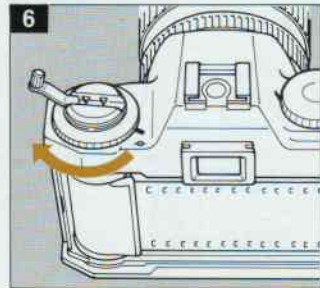
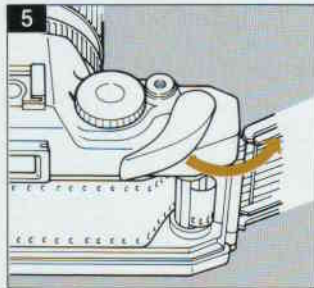

- 6) Slowly turn the rewind crank clockwise to take up the film slack.

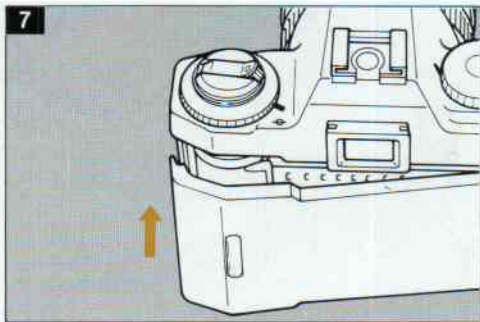

- 7) Close the back cover and make sure that it closes securely with a click. Press the shutter button completely to take a blank shot.

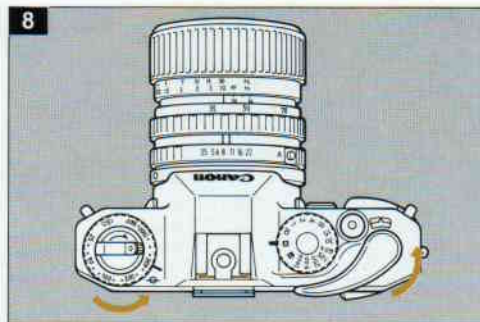

- 8) Advance the film one frame by slowly winding the film advance lever until it stops.

The film crank knob also serves as a film load confirmation. It rotates when the film advance lever is wound to confirm proper film load.

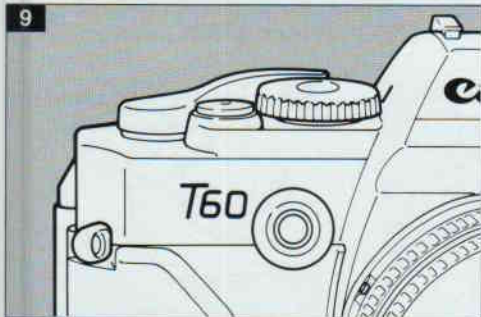

- 9) Press the shutter button completely to take a blank shot.

When the selector dial is set to "A", shutter release is slightly slow due to the aperture-priority AE function. Set the dial to "1000" when loading the film.



- 10) Continue advancing the film in this manner until "1" appears in the frame counter.

- The frame counter numbers are as follows.

S ▪ ▪ 1 ▪ ▪ 4 ▪ 6 ▪ 8 ▪ 10 ▪
 12 ▪ 14 ▪ 16 ▪ 18 ▪ 20 ▪ 22 ▪
 24 ▪ 26 ▪ 28 ▪ 30 ▪ 32 ▪ 34 ▪
 36 ▪

- S, 12, 20, 24, and 36 appear in red.

See p. 23 for film rewinding and removal.

Taking Pictures

1. Automatic Exposure Operation

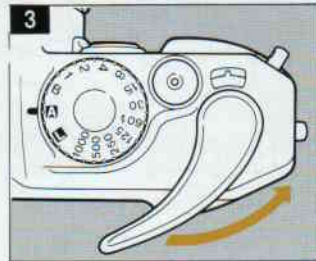
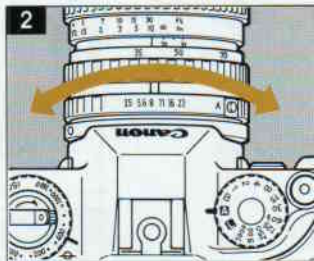

This camera is equipped with an "Aperture-priority AE" automatic exposure mode. In this mode, all you have to do is set the desired aperture and the camera automatically sets the shutter speed according to the brightness of the scene to achieve a correct exposure.

- 1) Set the selector dial to "A".
- 2) Turn the aperture ring to set the desired aperture.

- Do not set the aperture ring to the "A" position. If set to this position, the aperture value will be set to the minimum aperture of the lens.

- 3) Advance the film.
 - If the film advance lever does not move, the film has already been advanced and you can proceed to the next step.



- 4) Look into the viewfinder and focus the subject.
- 5) Press the shutter button halfway and check the viewfinder information display to confirm the exposure.
- 6) Press the shutter button completely to take the picture.



■ Confirming the exposure

- The exposure will be correct if the "AUTO" LED is lit and one of the LEDs between "1000" and "LT" lights up.



Note:

Camera shake is likely to occur if the shutter speed is slower than a speed equivalent to “1/lens focal length” sec. If the camera sets a shutter speed slower than this value, either use a tripod or change to a larger aperture so that a faster shutter speed is set. (For example, using a 100 mm lens, camera shake is likely at shutter speeds slower than 1/100 sec. Accordingly, make sure the shutter speed is set to 1/125 sec or faster or use a tripod.)



- If the “LT” LED lights, a slow shutter speed in the range of 2 to 8 seconds is set.



- If the “OVER” LED lights, change to a smaller aperture (set to a larger number on the aperture ring) until the “OVER” LED goes out.

2. Removing the Film

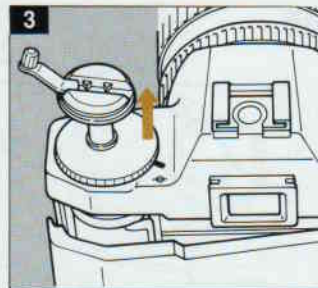
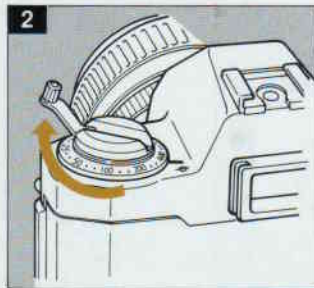
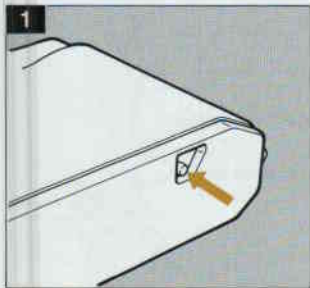

The film advance lever locks at the end of the film. When this occurs, the number of completed exposures indicated on the frame counter should equal or slightly exceed the number of exposures listed on the film package. Rewind and remove the film as follows.

- 1) Press the rewind button.
 - The rewind button locks in place after it is pressed in.

- 2) Lift the rewind crank and turn it clockwise to rewind the film. When the tension of the rewind crank loosens suddenly, rewinding is completed. Stop turning the rewind crank.
- 3) Pull the rewind crank knob up to open the back cover and remove the film. Avoid direct sunlight when unloading film. Unload film indoors or in a shaded area.

3. Manual Exposure Operation

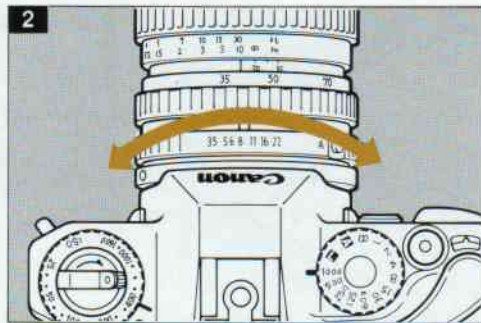
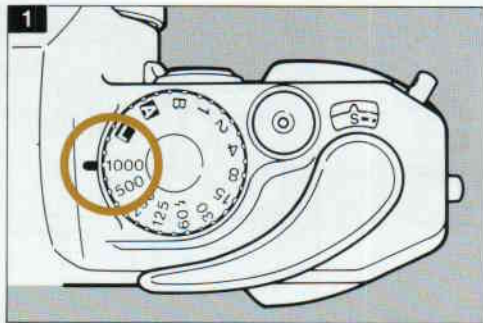

In manual exposure mode, you can freely set both the shutter speed and the aperture while confirming the exposure in the viewfinder.

- 1) Set the selector dial to one of the shutter speed settings (1000-1).

- 2) Turn the aperture ring to set the desired aperture.



- 3) Look into the viewfinder and focus the subject.
- 4) Press the shutter button halfway and check the viewfinder information display to confirm the exposure. Readjust the shutter speed and/or aperture settings if necessary.
- 5) Press the shutter button completely to take the picture.



■ Confirming the exposure

- The exposure will be correct if “M” and the shutter speed set on the selector dial are lit. No other LEDs should be blinking.
- If an LED is blinking, the current shutter speed/aperture setting combination will result in an incorrect exposure. Readjust the settings to obtain a correct exposure as described on the next page.



Overexposure

Overexposure will occur if an LED higher than the set shutter speed is blinking or if the “OVER” LED is blinking. In this situation, two methods are available to obtain a correct exposure:

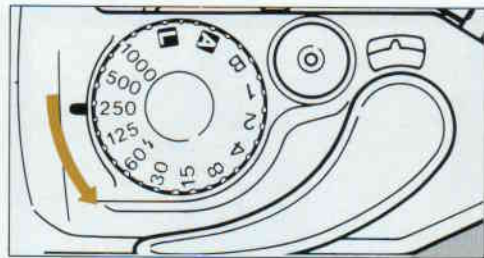

- ② Turn the selector dial to a faster shutter speed setting until the LED remains steadily lit.

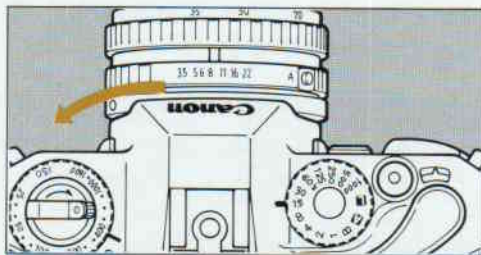

- ① Close down the aperture (turn the aperture ring to a larger number) until the LED remains steadily lit.



Underexposure

Underexposure will occur if an LED lower than the set shutter speed is blinking. Use one of the following two methods to obtain a correct exposure:

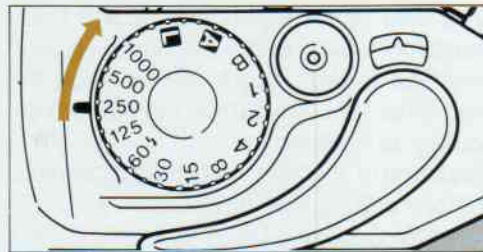

- ② Turn the selector dial to a slower shutter speed setting until the LED remains steadily lit.

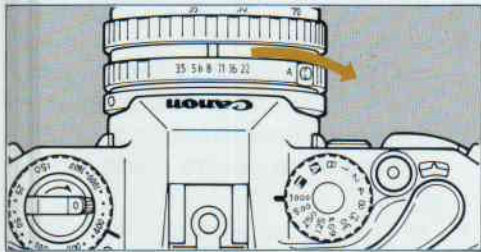

- ① Open up the aperture (turn the aperture ring to a smaller number) until the LED remains steadily lit.

4. Self-timer Function

The T60 is equipped with a self-timer function which enables you to include yourself in the picture. When using the self-timer function, attach the camera securely to a tripod.

Make sure the film has been advanced before setting this function.

- 1) Compose and focus the picture. Confirm the exposure.
- 2) Press the self-timer button while looking through the viewfinder.

When the self-timer button is pressed, it starts blinking and the shutter releases after approx. 10 seconds. Two seconds before the shutter releases, it blinks rapidly.

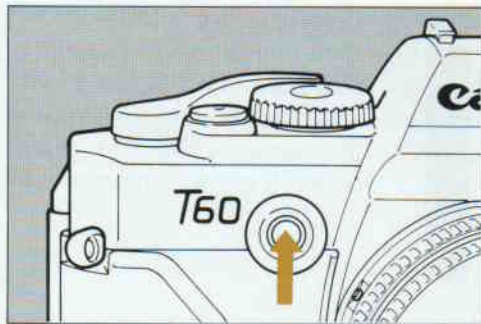

- *Do not remove your eye from the viewfinder eyepiece before pressing the self-timer button.* Stray light entering the eyepiece might cause the light meter to set an incorrect exposure.
- There is no viewfinder information display when using the self-timer.
- Cancel the self-timer before shutter release by pressing the shutter button halfway or by setting the selector dial to "L".

5. Bulb (Long Exposure) Shooting



In Bulb mode, the shutter remains open for as long as the shutter button is pressed. This enables you to take pictures which require long exposures such as night scenes and fireworks displays.

When using Bulb mode, mount the camera securely on a tripod and use a cable release to trip the shutter.

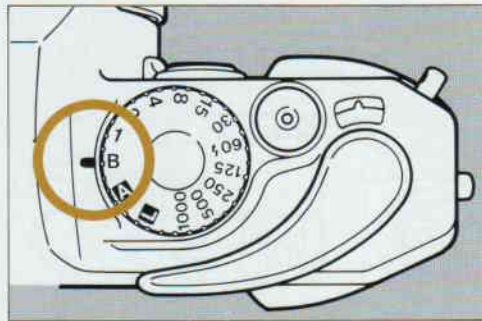

- 1) Set the selector dial to "B".

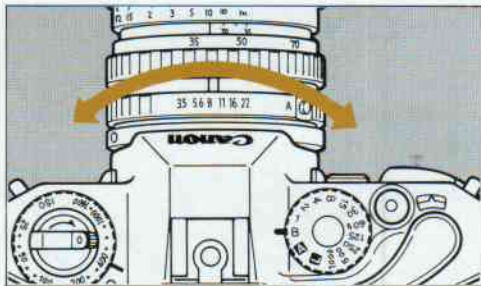

- 2) Set the desired aperture.
- 3) Compose the picture and focus the subject.

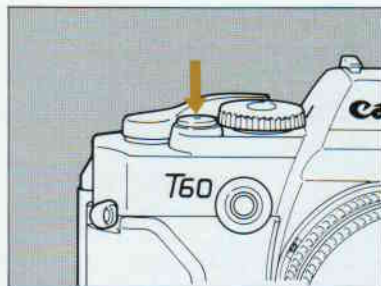

- 4) Press the shutter button completely and hold it down for the desired length of time.
 - If the shutter button is pressed half-way, "M" and "B" light in the viewfinder.
 - The self-timer function cannot be combined with Bulb mode.

6. Using Infrared Film

When using black-and-white infrared film — film which is sensitive to infrared light rays — you must slightly adjust the focus before taking a picture. This is necessary because infrared light rays have longer wavelengths and thus focus on a plane slightly behind that of ordinary visible light rays.

You can easily adjust the focus using the red infrared index on the lens barrel.

- When using black-and-white infrared film, it is necessary to attach a deep red filter to the lens to keep out the visible light rays. For details on the type of filter to use, refer to the instruction sheet provided with the film.

- 1) Attach a deep red filter to the lens.
- 2) Look through the viewfinder and focus the subject.



- 3) Note the focusing distance indicated by the distance index on the lens barrel.

7. Flash Photography

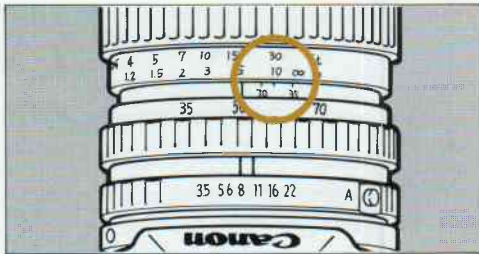

- 4) Turn the focusing ring to align the focusing distance noted above with the infrared index.
- 5) Press the shutter button to take the picture.
 - Automatic exposure cannot be carried out when using black-and-white infrared film because the camera's metering system measures visible light to determine exposure. Exposure settings must be made manually according to the exposure information provided with the film.

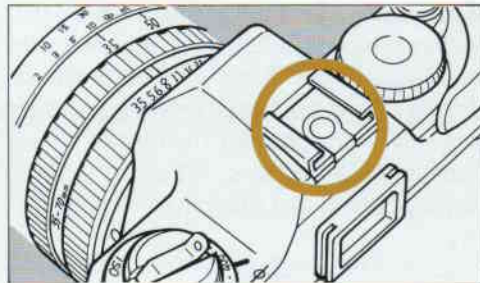

Most general-purpose flash units can be used with the T60 for taking flash pictures. Attach the flash unit to the accessory shoe on top of the camera.

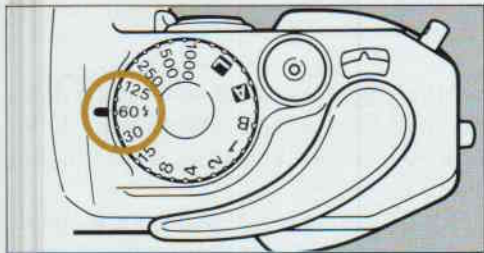

- 1) Set the selector dial to 60 $\frac{1}{2}$.
- 2) Set the appropriate aperture.
 - For details on setting the aperture, refer to the instructions provided with the flash unit.
- 3) Focus the subject and take the picture.
 - If the shutter button is pressed halfway, "M" and "60 $\frac{1}{2}$ " light up in the viewfinder.



- Shutter speeds of 1/60 sec. or slower can be used for taking flash pictures.
- It is recommended to use a flash unit that can automatically adjust its light output.

Appendix

1. Understanding Depth of Field

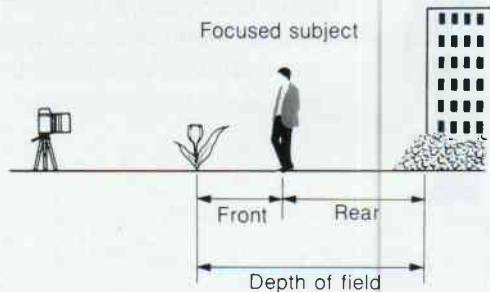

When you focus on a subject, there is a certain distance range in front of and behind the subject which is also in focus. This range of sharpness is called depth of field.

Depth of field varies according to different factors as described below. By varying the depth of field, you can change the impact of a picture. For example, a shallow depth of field is often used for portraits to separate the subject from a

distracting background, whereas a deep depth of field is most effective for landscapes in which you want everything in sharp focus.

- 1) With the lens focused on a subject, the range of focus (depth of field) generally extends twice as far behind the subject as in front of the subject.
- 2) Setting the lens to a smaller aperture (larger aperture number) increases the depth of field, while setting a larger aperture (smaller aperture number) results in a shallower depth of field.
- 3) Depth of field increases as the shooting distance increases.
- 4) With the aperture and shooting distance held the same, a lens with a shorter focal length will provide a greater depth of field.

■ Comparing depth of field



f/4 Small lens aperture number
Shallow depth of field



f/16 Large lens aperture number
Deep depth of field

2. Film Plane Indicator

The film plane indicator shows the actual position of the film inside the camera. The distance scale on the lens is based on this position.

Although the film plane indicator is not used in general picture-taking situations, it can be used to determine exact shooting distances when taking close-up pictures.

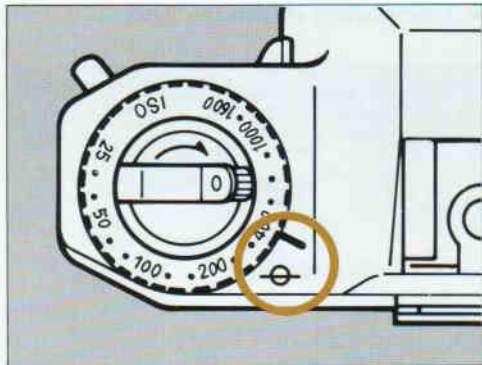

Interchangeable Lenses

The entire line-up of FD lenses, known for their superior image quality and used by professional photographers worldwide,



1. FD 28 mm f/2.8



2. Macro FD 50 mm f/3.5

can be used with the T60. Pictures taken with four commonly-used FD lenses are below.



3. FD 35-70 mm f/3.5-4.5



4. FD 75-200 mm f/4.5

Accessories

1. Cases (Sold Separately)

Two cases designed exclusively for the T60 are available to provide protection when carrying the camera.

- Case S: For T60 with FD 50 mm f/1.8 lens
- Case L: For T60 with FD 35-70 mm f/3.5-4.5 lens
- When carrying the camera on your shoulder, keep the lens facing toward your body to minimize the risk of damage.

2. Dioptric Adjustment Lenses (Sold Separately)

The Canon Dioptric Adjustment Lenses can be attached to the viewfinder eyepiece to enable near- and far-sighted users to see a sharp viewfinder image without using glasses. Although the eyepiece has a standard diopter of -1 dpt, this can be varied to match your eyesight by attaching one of 10 dioptric adjustment lenses. Before purchase, test the lens to be sure it is correct for your eyesight. Attach the dioptric adjustment lens by sliding it into the viewfinder eyepiece groove from the top.

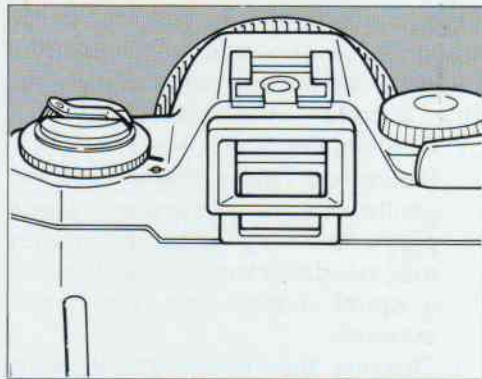

Camera Care

Keep your camera in top condition by following these suggestions for periodic cleaning. See the precautions on p. 4 for other important information.

1. Cleaning the lens surface -
Blow off dust with a blower brush and gently wipe the lens surface with a piece of lens cleaning paper moistened with lens cleaner. Clean in a **spiral** motion from the center outwards.
2. Cleaning the mirror and focusing screen -
Use a blower brush reserved for this use only. If more cleaning is necessary NEVER attempt to do it yourself. Take the camera to an authorized Canon service facility.
3. Cleaning the film chamber -
Use a blower brush to remove accumulated film dust particles that might scratch the film. Be careful not to touch the shutter curtain.

Specifications

Type: 35 mm focal plane shutter SLR (single-lens reflex) camera.

Usable Lenses: Canon FD lenses

Lens Mount: Canon mount (FD-type signal transfer mechanism)

Viewfinder: Eye-level pentaprism single-lens reflex type. Gives 93% vertical and horizontal coverage of actual picture area.

Focusing Screen: Fixed, provided with split-image/micropism rangefinder.

Viewfinder Information: Provided by 16 LEDs which light or blink.

(1) Shooting mode LEDs: AUTO, M, 60 $\frac{1}{2}$, B (light)

(2) Shutter speed LEDs: 1/1000 sec - 1 sec, LT (12 steps) (light or blink)

(3) Overexposure warning LED: OVER (lights)

Mirror: Quick-return total-reflection mirror

Light Metering: TTL full-aperture center-weighted average metering using SPC photocell.

Exposure Control: (1) AUTO: Aperture-priority AE; (2) MANUAL: By matching the lit and blinking LEDs.

Metering Range: EV 2-18 with 50mm f/1.8 lens at ISO 100.

Out-of-Coupling-Range Warning: "OVER" LED lights in high brightness situations.

Exposure Reading: Carried out when shutter button is pressed halfway.

Film Speed Range: ISO 25-1600, manually set in 1/3-stop increments.

Shutter: Vertical-travel metal focal plane shutter with all speeds electronically controlled.

Shutter Speed Range: 1/1000 sec to 8 sec (stepless) in aperture-priority AE mode; 1/1000 sec to 1 sec (1-stop increments) and bulb in manual mode.

Flash Sync Speed: 1/60 sec.

Shutter Release System: Electromagnetic release system.

Self-timer: Electronically-controlled 10-second delay timer, activated by self-timer button; LED blinks during delay period.

Film Loading: Loading and winding carried out by toothed, multi-slit spool.

Film-loading Confirmation: Visual check via film window.

Film Advance: Film advance lever.

Frame Counter: Mechanical, sequential counting type. Automatically reset when back cover is opened.

Film Rewinding: Film manually rewound by pressing rewind button and turning rewind crank.

Back Cover: Opened by pulling up rewind crank knob.

Flash Contacts: X-sync contact on accessory shoe.

Power Source: Two LR44 alkaline batteries or two SR44 silver batteries. Battery life approximately one year under normal use.

Battery Check: Viewfinder LEDs light when shutter button pressed halfway.

Tripod Socket: CU-1/4

Dimensions: 5-3/8" (W) × 3-3/8" (H) × 1-13/16" (D) (136 × 86 × 46.5 mm)

Weight: 12.6 oz (360 g) (body only with batteries)

All data are based on Canon's Standard Test Method.

Subject to change without notice.

Canon

CANON INC., 7-1, Nishi-Shinjuku 2-Chome, Shinjuku-ku, Tokyo 163, Japan
Mailing address: P.O. Box 5050, Dai-ichi Seimei Building, Tokyo 163, Japan

- U.S.A. _____ **CANON U.S.A., INC. HEADQUARTERS**
One Canon Plaza, Lake Success, N.Y. 11042, U.S.A.
CANON U.S.A., INC. ATLANTA OFFICE
5625 Oakbrook Parkway, Norcross, Ga. 30093, U.S.A.
CANON U.S.A., INC. CHICAGO OFFICE
100 Park Blvd, Itasca, Il. 60143-2093, U.S.A.
CANON U.S.A., INC. LOS ANGELES OFFICE
123 Paulerino Avenue East, Costa Mesa, Cal. 92626, U.S.A.
CANON U.S.A., INC. SANTA CLARA BRANCH
4000 Burton Drive, Santa Clara, Cal. 95054, U.S.A.
CANON U.S.A., INC. DALLAS OFFICE
3200 Regent Blvd, Irving, Tex. 75063-3145, U.S.A.
CANON U.S.A., INC. HONOLULU BRANCH
1020 Auahi St., Bldg. #8, Honolulu, Hawaii 96814, U.S.A.
CANON U.S.A., INC. WASHINGTON D.C. BRANCH
5701 General Washington Drive, Alexandria, Va. 22312, U.S.A.
- CANADA _____ **CANON CANADA INC. HEADQUARTERS**
6390 Dixie Road, Mississauga, Ontario L5T 1P7, Canada
CANON CANADA INC. MONTREAL SERVICE CENTRE
10552 Côte de Liesse, Lachine, Québec H8T 1A5, Canada
CANON CANADA INC. CALGARY OFFICE
2628, 16th Street, N.E. Calgary, Alberta T2E 7K7, Canada
- EUROPE, AFRICA
& MIDDLE EAST _____ **CANON EUROPA N.V.**
Bovenkerkerweg 59-61, P.O. Box 2262, 1180 EG Amstelveen, The Netherlands
CANON PHOTO VIDEO FRANCE S.A.
"Le Doudou" 11, Avenue Dubonnet 92407 Courbevois Cedex, France
CANON UK LTD.
Units 4 & 5, Brent Trading Centre, North Circular Road, London NW10 0JF, United Kingdom
CANON EURO-PHOTO G.m.b.H.
Siemensring 90-92, D-4156 Willich 1, West Germany
- CENTRAL &
SOUTH AMERICA _____ **CANON LATIN AMERICA, INC. DEPTO. DE VENTAS**
Apartado 7022, Panamá 5, República de Panamá
CANON LATIN AMERICA, INC. CENTRO DE SERVICIO Y REPARACION
Apartado 2018, Zona Libre de Colón, República de Panamá
- SOUTHEAST ASIA _____ **CANON HONG KONG TRADING CO., LTD.**
Room 1101-3 & 1121-2, Peninsula Centre, 67 Mody Road, Tsimshatsui East, Kowloon,
Hong Kong
CANON SINGAPORE PTE. LTD.
95 South Bridge Road # 13-01/15, South Bridge Centre, Singapore 0105
- OCEANIA _____ **CANON AUSTRALIA PTY. LTD.**
1 Thomas Holt Drive, North Ryde, N.S.W. 2113, Australia
CANON OPTICS NEW ZEALAND LTD.
Fried Thomas Drive, P.O. Box 33-336, Takapuna, Auckland, New Zealand
- JAPAN _____ **CANON SALES CO., INC.**
11-28, Miya, 3-Chome, Minato-ku, Tokyo 106, Japan