

KENWOOD

KDC-4590R

KDC-4590RV

KDC-4090R

KDC-3090RG

KDC-3090RA

KDC-305RG

KDC-305RA

CD-RECEIVER

INSTRUCTION MANUAL

KENWOOD CORPORATION

B64-1835-00 (EN)



Contents

Safety precautions	3
---------------------------------	----------

Handling Compact discs	5
-------------------------------------	----------

General features

Power.....	7
Volume.....	7
Attenuator.....	7
Switching Modes.....	8
Loudness.....	8
System O.....	8
Mobile Preset.....	9
TEL Mute.....	9
Audio Control Setting.....	10
Theft Deterrent Faceplate.....	10

Tuner features

Tuning.....	12
Station Preset Memory.....	12
Clock display.....	12

RDS features

RDS (Radio Data System).....	13
Traffic Information Function.....	14
Programme Type (PTY) Function.....	14
Enhanced Other Network.....	15
Alarm.....	15
Presetting Volume for Traffic Information/News.....	16

CD/External disc control features

Playing CDs.....	17
Playing Other Disc mode.....	17
Switching Display for Discs.....	18
Fast Forwarding and Reversing Disc Play.....	18
Track Search.....	18
Disc Search.....	19
Track / Disc Repeat.....	19
Track Scan.....	19
Random Play.....	20
Magazine Random Play.....	20
Presetting Disc Names (DNPS).....	20
Text Scroll.....	21

Menu settings

Menu System.....	22
Touch Sensor Tone.....	23
Manual Time Adjustment.....	23
Automatic Time Adjustment.....	23
Disabled System Indicator (DSI).....	23
Selectable Illumination.....	24
News Bulletin Function with PTY News Timeout Setting.....	24
Local Seek Function.....	24
Selecting Tuning Mode.....	24
Auto Memory Entry.....	24
AF (Alternative Frequency) Function.....	25
Restricting RDS Region (Region Restrict Function).....	25
Auto TP Seek Function.....	25
Monaural Reception.....	26
Text Scroll.....	26
Name Preset.....	26
Power OFF Timer.....	26

Installation

Accessories.....	27
Installation Procedure.....	27
Connecting Cables to Terminals.....	28
Installation.....	29

Troubleshooting Guide	31
------------------------------------	-----------

Specifications	35
-----------------------------	-----------

Safety precautions

▲WARNING

To prevent injury and/or fire, take the following precautions:

- Insert the unit all the way until it is fully locked in place. Otherwise it may fly out of place during collisions and other jolts.
- When extending the ignition, battery or ground cables, make sure to use automotive-grade cables or other cables with an area of 0.75mm² (AWG18) or more to prevent cable deterioration and damage to the cable coating.
- To prevent short circuits, never put or leave any metallic objects (e.g., coins or metal tools) inside the unit.
- If the unit starts to emit smoke or strange smells, turn off the power immediately and consult your Kenwood dealer.
- Make sure not to get your fingers caught between the faceplate and the unit.
- Be careful not to drop the unit or subject it to strong shock.
The unit may break or crack because it contains glass parts.
- Do not touch the liquid crystal fluid if the LCD is damaged or broken due to shock.
The liquid crystal fluid may be dangerous to your health or even fatal.
If the liquid crystal fluid from the LCD contacts your body or clothing, wash it off with soap immediately.

▲CAUTION

To prevent damage to the machine, take the following precautions:

- Make sure to ground the unit to a negative 12V DC power supply.
- Do not open the top or bottom covers of the unit.
- Do not install the unit in a spot exposed to direct sunlight or excessive heat or humidity. Also avoid places with too much dust or the possibility of water splashing.
- Do not set the removed faceplate or the faceplate case in areas exposed to direct sunlight, excessive heat or humidity. Also avoid places with too much dust or the possibility of water splashing.
- To prevent deterioration, do not touch the terminals of the unit or faceplate with your fingers.
- Do not subject the faceplate to excessive shock, as it is a piece of precision equipment.
- When replacing a fuse, only use a new one with the prescribed rating. Using a fuse with the wrong rating may cause your unit to malfunction.
- To prevent short circuits when replacing a fuse, first disconnect the wiring harness.
- Do not place any object between the faceplate and the unit.
- During installation, do not use any screws except for the ones provided. The use of improper screws might result in damage to the main unit.

IMPORTANT INFORMATION

About the disc changer to be connected:

To connect a disc changer having the "O-N" switch to this unit, set the "O-N" switch to "N".

To connect a disc changer having no "O-N" switch to this unit, the converter cord CA-DS100 and/or switching adapter KCA-S210A are required as options.

If a model with no "O-N" switch is connected, some unavailable functions and information that cannot be displayed are generated, such as the DNPS, DNPP, Magazine random play, and CD Text display. Note that none of the KDC-C100, KDC-C302, C205, C705, and non-Kenwood CD changers can be connected.

▲CAUTION

You can damage both your unit and the CD changer if you connect them incorrectly.

▲CAUTION

Do Not Load 8-cm (3-in.) CDs in the CD slot

If you try to load an 8-cm CD with its adapter into the unit, the adapter might separate from the CD and damage the unit.

Safety precautions

NOTE

- If you experience problems during installation, consult your Kenwood dealer.
- If the unit does not seem to be working right, try pressing the reset button first. If that does not solve the problem, consult your Kenwood dealer.

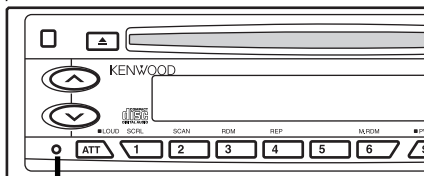

Reset button

- Characters in the LCD may become difficult to read in temperatures below 41 °F (5 °C).
- The illustrations of the display and the panel appearing in this manual are examples used to explain more clearly how the controls are used. Therefore, what appears on the display in the illustrations may differ from what appears on the display on the actual equipment, and some of the illustrations on the display may represent something impossible in actual operation.
- The functions that can be used and the information that can be displayed will differ depending on the external disc players being connected.

Cleaning the Faceplate Terminals

If the terminals on the unit or faceplate get dirty, wipe them with a dry, soft cloth.

Cleaning the Unit

If the faceplate of this unit is stained, wipe it with a dry soft cloth such as a silicon cloth. If the faceplate is stained badly, wipe the stain off with a cloth moistened with neutral cleaner, then wipe neutral detergent off.

CAUTION

Applying spray cleaner directly to the unit may affect its mechanical parts. Wiping the faceplate with a hard cloth or using a volatile liquid such as thinner or alcohol may scratch the surface or erase characters.

The marking of products using lasers (Except for some areas)

**CLASS 1
LASER PRODUCT**

The label is attached to the chassis/case and says that the component uses laser beams that have been classified as Class 1. It means that the unit is utilizing laser beams that are of a weaker class. There is no danger of hazardous radiation outside the unit.

Cleaning the CD Slot

As dust can accumulate in the CD slot, clean it occasionally. Your CDs can get scratched if you put them in a dusty CD slot.

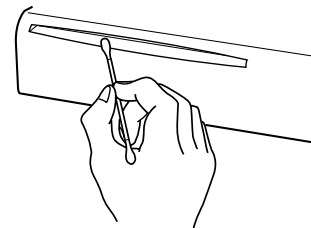

Lens Fogging

Right after you turn on the car heater in cold weather, dew or condensation may form on the lens in the CD player of the unit. Called lens fogging, CDs may be impossible to play. In such a situation, remove the disc and wait for the condensation to evaporate. If the unit still does not operate normally after a whilst, consult your Kenwood dealer.

Handling Compact discs

Playing a CD that is dirty, scratched or warped can cause the sound to skip and the unit to operate incorrectly, resulting in worsened sound quality. Take the following precautions to prevent your CDs from getting scratched or damaged.

Handling CDs

- Do not touch the recorded side of the CD (i.e., the side opposite the label) when holding it.

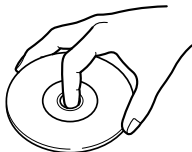

- The reflective film on a CD-R or a CD-RW is more fragile than that on an ordinary music CD, and may peel off if scratched. Fingerprints on a CD-R or CD-RW are also more likely to cause skipping when the disc is played. For these reasons, handle the disc very carefully. Detailed handling instructions will appear on the CD-R or CD-RW package: read this information carefully before using the disc.
- Do not stick tape on either side of the CD.

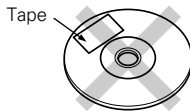

Storing CDs

- Do not store CDs in areas exposed to direct sunlight – such as a car seat or above the fascia panel (dashboard) – or other hot places. A CD-R or CD-RW is more susceptible than a music CD to damage from high temperatures and humidity, and in some cases, may become unusable if left in the car for long periods of time.
- Remove CDs from the unit when not listening to them for a whilst, and put them back in their cases. Do not stack CDs that have been removed from their cases or prop them against something.

Cleaning CDs

If a CD has become dirty, wipe it off gently using a commercially available cleaning cloth or a soft cotton cloth, starting from the centre of the disc and moving outward. Do not clean CDs with conventional record cleaners, anti-static formulas, or chemicals such as paint thinner or benzene.

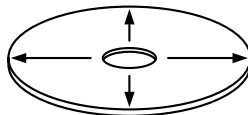

Checking New CDs for Burrs

When playing a new CD for the first time, check that there are not any burrs stuck to the perimeter of the disc or in the central hole. CDs with burrs stuck on them may not load properly or may skip whilst playing. Remove burrs using a ballpoint pen or a similar utensil.

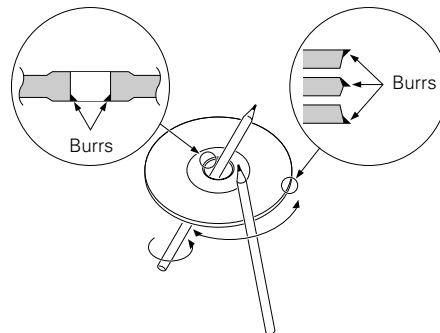

Handling Compact discs

Do Not Load CD Accessories in Slot

Do not use commercially available CD accessories that can be loaded into the CD slot, such as stabilisers, protective sheets, or CD cleaning discs, since they can cause the unit to malfunction.

Removing the CD

Only remove the CD from the machine in a horizontal direction. You may damage the surface of the CD if you try pulling it down as it ejects.

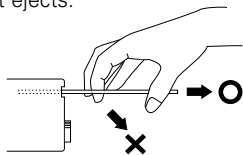

Do Not Use Special Shape CDs

• Be sure to use round shape CDs only for this unit and do not use any special shape CDs. Use of special shape CDs may cause the unit to malfunction.



- Be sure to use CDs with disc mark  only for this unit.
- CD-Rs and CD-RWs which have not undergone finalization processing cannot be played. (For more information on finalization processing, refer to the manual for your CD-R/CD-RW writing software or CD-R/CD-RW recorder.) Additionally, depending on the recording status, it may prove impossible to play certain CDs recorded on CD-R or CD-RW.

Do Not Use CDs with Sticker on the Labelled Side

Do not use the CD with the label sticker stuck on it.

Using such a CD may cause the CD to be deformed and the sticker to peel off, resulting in malfunction of the unit.

General features

Release button

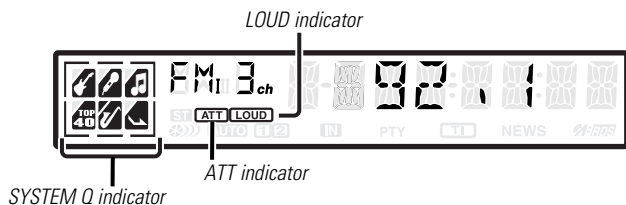
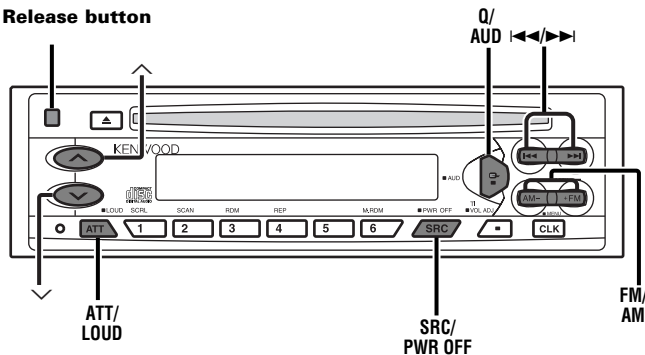

Power

Turning on the power:

Press the SRC button.

NOTE

Turn the power on before carrying out the following procedures.

Turning off the power:

Hold down the PWR OFF button for one second or more.

Volume

Increasing Volume:

Press the \wedge button to turn up the volume.

Decreasing Volume:

Press the \vee button to turn down the volume.

Attenuator

This function allows you to turn down the volume quickly.

Turning Attenuator On/Off:

Press the ATT button to switch the attenuator on and off.

When the attenuator is on, the ATT indicator blinks.

When the attenuator is off, the volume returns to the original level.

NOTE

Turning the volume up, or turning it all the way down deactivates the attenuator function.

General features

Switching Modes

Switching Modes:

Each time you press the SRC button, the mode switches as follows:

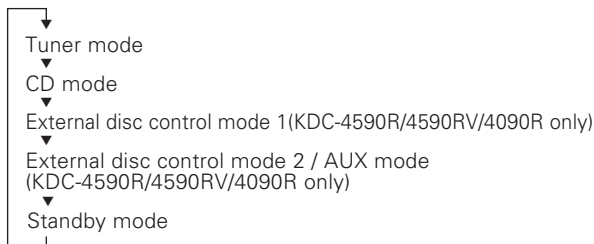

Selecting the standby mode:

Press the SRC button repeatedly to select to "ALL OFF". When "ALL OFF" is displayed, the standby mode is turned on. The standby mode turns all functions off although leaving the unit's power on. Use this mode when you want to have the display illuminated but do not want to listen to anything.

NOTE

- The mode switches to the next mode from any mode which cannot be used.
- The external disc control mode will differ depending on the unit that is connected.
- To enable the selection of External disc control mode 2/AUX mode, you should connect optional switching adapter KCA-S210A (which allows you to select both External disc control mode 2 and AUX mode) or CD changer (KDC-CPS87, KDC-CX87, KDC-CPS85, KDC-CX85, KDC-CPS82 or KDC-CX82) or switching adapter CA-C1AX (which allows you to select AUX mode only).

During the AUX mode, "AUX" will show in the display. When the CA-C1AX is being used, the AUX Mode will replace the External Disc Control Mode.

- If you have selected Standby mode, the timer function that turns the power off automatically will be activated. To find out how to set the time on the timer, and how to cancel

the timer function, refer to the section on the Power OFF Timer function under Menu settings (page 22).

Loudness

This function amplifies low and high tones when the volume is turned down.

The LOUD indicator lights up, when the loudness function is on.

Turning Loudness On/Off:

Hold down the LOUD button for one second or more to switch the loudness on and off.

System Q

You can recall the best audio setting preset for different types of the music.

Switching the Preset Sound Setting:

Each time you press the Q button, the preset sound setting switches as follows:

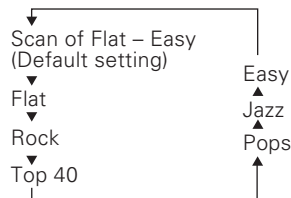

As you proceed, each indicator would go on.

NOTE

The System Q function changes the values of the following sound quality parameters:

Bass centre frequency, bass level, bass quality factor, bass extend, middle centre frequency, middle level, middle quality

factor, treble centre frequency, and treble level. Note that some of these parameters cannot be controlled by the audio control setting feature. Their setting values are different depending on the setting of the mobile preset plan mode. (KDC-4590R/4590RV only)

Function of the KDC-4590R/KDC-4590RV

Mobile Preset

This function allows you to adjust the setting that is recalled with the System Q, according to types of speakers.

- 1 Press the SRC button repeatedly to select the standby mode. "ALL OFF" is displayed when the standby mode is selected.
- 2 Press the Q button to enter the mobile preset plan mode.
- 3 Press either the **◀◀** or **▶▶** button to select the type of speaker. The setting switches as follows.
Off ("SP OFF") / For the OEM speaker ("SP OEM") / For 6/6x9 in. speaker ("SP 6/6x9") / For 5/4 in. speaker ("SP 5/4")
- 4 Press the Q button to end the mobile preset plan mode.

NOTE

When you change the type of speaker setting, the bass, middle and treble tone settings are returned to original levels.

TEL Mute

Shut down the audio system temporarily whenever an incoming call is received.

NOTE

The function will not work if a cable is not connected to the car phone.

When the telephone rings:

When a call is received, "CALL" is displayed and all the unit functions are temporarily interrupted.

Restoring Original Unit Source During Phone Call:

Press the SRC button.
"CALL" disappears from the display, and the volume of the original source is restored gradually.

Turning TEL Mute Function Off After Phone Call:

Hang the phone up.
"CALL" disappears from the display.
The original source (i.e., the one used before the phone call) is returned to automatically, and the volume restored gradually.

General features

Audio Control Setting

Adjust various parameters of sound quality.

1 Hold down the AUD button for one second or more to enter the control mode.

2 **Selecting mode**

Press either the FM or AM button.

Each time the button is pressed, the adjustment mode will change as follows:

Pressing the FM button advances the display, and pressing the AM button reverses it.

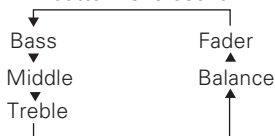

NOTE Source tone memory

Each source (CD, MD, FM, AM and disc changer) has its own memory in which to store the bass, middle and treble tone settings.

The settings made for a particular source are then recalled automatically whenever you use that source (e.g., FM mode uses the tone settings made for FM, AM for AM, etc.).

3 **Adjust each mode**

Press the ◀▶ button.

Look at the table to adjust the mode being displayed.

Adjustment mode (Display)	Operation of Audio control button	
	◀▶ button	▶▶ button
Bass ("BAS")	Bass decreased.	Bass increased.
Middle("MID")	Middle decreased.	Middle increased.
Treble("TRE")	Treble decreased.	Treble increased.
Balance("BAL")	Left channel emphasized.	Right channel emphasized.
Fader ("FAD")	Rear channel increased.	Front channel increased.

4 Press the AUD button to end the control mode.

NOTE

Determining the parameters in the audio control setting will clear all the adjustments made in the System Q and they are replaced with the values made in the audio control setting.

Theft Deterrent Faceplate

The faceplate of the unit can be detached and taken with you, helping to deter theft.

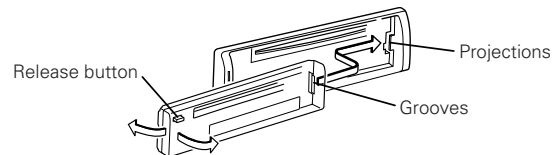

Removing Faceplate:

Press the Release button.

The faceplate is unlocked, allowing you to detach it.

NOTE

- The faceplate is a precision piece of equipment and can be damaged by shocks or jolts. For that reason, keep the faceplate in its special storage case whilst detached.

Tuner features

- Do not expose the faceplate or its storage case to direct sunlight or excessive heat or humidity. Also avoid places with too much dust or the possibility of water splashing.

Reattaching Faceplate:

- 1 Align the projections on the unit with the grooves on the faceplate.
- 2 Push the faceplate in until it clicks.
The faceplate is locked in place, allowing you to use the unit.

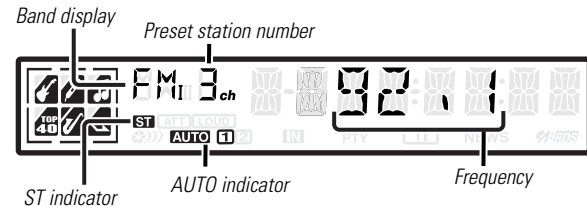
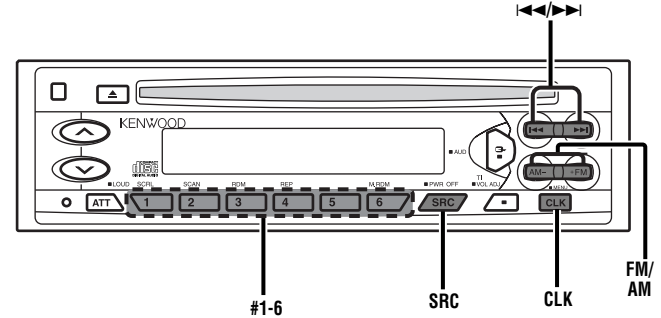

Tuner features

Tuning

- 1 Press the SRC button repeatedly until the tuner mode is obtained. "TUNER" is displayed only when the tuner mode is selected.
- 2 Press either the FM or AM button to select the band. Each time you press the FM button, the band switches between the FM1, FM2 and FM3. Press the AM button to select the MW and LW bands.
- 3
 - Auto Seek Tuning
 - Press the ►► button to seek increasing frequencies.
 - Press the ◀◀ button to seek decreasing frequencies.
 - Preset station seek tuning
 - Press the ►► button to move to the next preset station (i.e., the one with the next highest number), and the ◀◀ button to move to the last preset station (i.e., the one with the next lowest number).

NOTE

If the frequencies stored at the preset numbers receive stations which were not originally memorized when travelling long distances, the preset number is not displayed. In such cases, pressing the ◀◀/►► button to use preset station seek will receive channel 1.

- Manual Tuning
 - Press the ►► button to increase the frequency by one step.
 - Press the ◀◀ button to decrease the frequency by one step.

NOTE

- The ST indicator lights up when stereo broadcasts are being received.
- Please see the menu settings about selecting tuning mode. (page 22)

- 1 Select the band/station that you want to have stored.
- 2 Hold down the button (#1-6) that you want to use for the station, for two seconds or more. The button number blinks once in the display to indicate that the data has been stored.

Recalling a Preset Station:

Press the preset station button (#1-6) for the desired station. The number of the recalled station is displayed.

NOTE

You can store 6 stations in each of the FM1, FM2, FM3, and AM (MW and LW) bands.

Clock display

Changing the Clock display:

Each time you press the CLK button, the display switches between the Programme Service name (during RDS station reception)/Station frequency and clock.

Station Preset Memory

Store the frequency of the station currently being listened to. You can then recall that station with a single touch of a button.

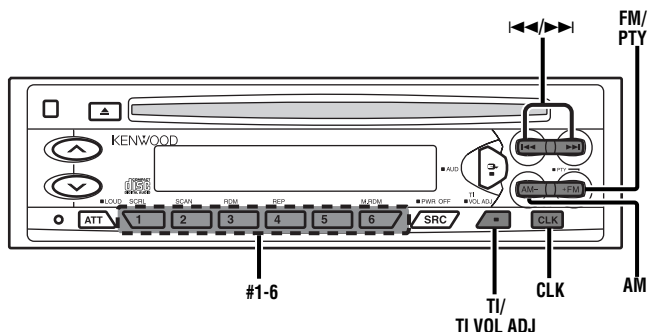

RDS (Radio Data System)

RDS is a digital information system that lets you receive signals besides those of regular radio programmes, such as network information being transmitted from radio stations. When listening to an RDS station (ie, a station with RDS capability), the programme service name of the station is displayed along with the frequency, advising you quickly which station is being received.

RDS (Radio Data System) stations also transmit frequency data for the same station. When you are making long trips, this function automatically switches to the particular frequency with the best reception for the particular network of stations that you want to listen to. The data is automatically stored, allowing you to switch quickly to another RDS stations, broadcasting the same programme, that has better reception. These include stations stored in the station preset memory that you often listen to.

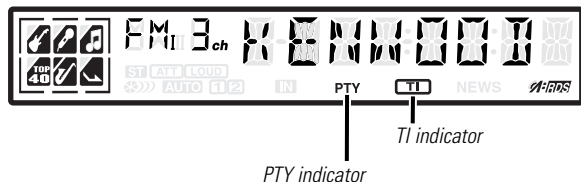

RDS features

Traffic Information Function

You can listen to traffic information. If you are listening to tapes or discs, they will continue playing until a traffic bulletin is broadcast.

Turning TI function On/Off:

Press the TI button to turn the function on and off.

When the function is on, the TI indicator is turned on.

When none is being received, the TI indicator will blink on and off. When a traffic information station is being received, the TI indicator will turn on.

When a traffic bulletin begins to be broadcast, "TRAFFIC" will be displayed, and reception will begin at the preset volume.

If you are listening to a tape or disc when a traffic bulletin begins, they will automatically be turned off. When the bulletin ends or poor reception is experienced, the tape or disc will begin playing again.

NOTE

Pressing the TI button whilst in the MW/LW band automatically switches reception to the FM band. However, the MW/LW band is not returned to when the TI button is pressed again.

Switching to a Different Traffic Information Station:

Use the ◀◀ / ▶▶ buttons to make an auto seek of the TI stations in a certain band.

NOTE

- When you are listening to a tape or disc, you cannot change to another TI station.
- When the auto TP seek function is turned on and reception starts to weaken, the tuner automatically seeks traffic information stations with better reception.
- If you are tuned to a station that is not a traffic information station itself but which provides <Enhanced Other Network> services, you can still have traffic information received.
- Holding down the TI button for one second or more when the TI function is on in the disc control mode results in a change to the frequency display of the traffic information station for five seconds.

Programme Type (PTY) Function

Conduct auto seek tuning only on those stations with selected kinds of programmes.

- 1 Hold down the PTY button for one second or more. "PTY" is displayed, and the Programme Type Selection (PTY) Mode entered. If you make no key input in 30 seconds, the mode will automatically turn off.

NOTE

You cannot use this function whilst the traffic bulletin is received.

NOTE Changing the Display Language to French or German

In the PTY mode, press the CLK button to display the name of the language currently used.

If you want to change the language, press the preset button for the desired language and then the CLK button.

English is #1, French is #2, and German is #3.

2 Select the type of programme to be received

- Press either the FM or AM button repeatedly until the type of programme you want to listen to.

The selection includes:

<i>Speech</i>	(SPEECH)
1. News	(NEWS)
2. Current Affairs	(AFFAIRS)
3. Information	(INFO)
4. Sports	(SPORT)
5. Education	(EDUCATE)
6. Drama	(DRAMA)
7. Culture	(CULTURE)
8. Science	(SCIENCE)
9. Varied	(VARIED)
10. Pop Music	(POP M)
11. Rock Music	(ROCK M)
12. Easy Listening Music	(EASY M)
13. Light Classical	(LIGHT M)
14. Serious Classical	(CLASSICS)
15. Other Music	(OTHER M)
16. Weather	(WEATHER)
17. Finance	(FINANCE)

- 18. Children's programmes (CHILDREN)
- 19. Social Affairs (SOCIAL A)
- 20. Religion (RELIGION)
- 21. Phone In (PHONE IN)
- 22. Travel (TRAVEL)
- 23. Leisure (LEISURE)
- 24. Jazz Music (JAZZ)
- 25. Country Music (COUNTRY)
- 26. National Music (NATION M)
- 27. Oldies Music (OLDIES)
- 28. Folk Music (FOLK M)
- 29. Documentary (DOCUMENT)
- Music (MUSIC)*
- (Speech.....1~9,16~23, 29, Music.....10~15, 24~28)

• You can select the type of programme directly by pressing a preset button. The buttons are factory-set to the following type of programmes:

- 1. *Music*
- 2. *Speech*
- 3. News
- 4. Other Music
- 5. Serious Classical
- 6. Varied

NOTE Changing the Preset Button Settings for Programme Type

After selecting the type of programme to be stored in a certain preset button, hold down that button for two seconds or more. The previously stored data for that button are erased and the new programme type is stored.

3 Seeking the selected programme type

Press the ◀◀ or ▶▶ button to make a seek of frequencies with your selected type of programme. The display blinks and the seek starts.

If your selected type of programme is found, the name of the station is displayed and the station is tuned into.

"PTY" blinks in the display for about 30 seconds.

If you make no key input in 30 seconds, the PTY selection mode will turn off automatically.

NOTE

If no programme can be found, "NO PTY" is displayed. If you want to select another type of programme, repeat steps 2 and 3 above.

Switching to Other Stations with the Same Type of Programme:

When "PTY" is blinking in the display, perform auto seek tuning.

The tuner scans for another station with the same type of programme.

Cancelling Programme Type Function During Its Operation:

Hold down the PTY button for one second or more.

Enhanced Other Network

Stations that offer <Enhanced Other Network> also transmit information about other RDS stations that have traffic information. When you are tuned to a station that is not transmitting traffic information, but another RDS station starts transmitting a traffic bulletin, the tuner automatically switches to the other station for the duration of the bulletin.

Alarm

When an emergency transmission (announcing disasters, etc.) is sent, all current functions are interrupted to allow the warning to be received.

RDS features

Presetting Volume for Traffic Information/News

Preset the volume level to be used for traffic information and news broadcasts.

- 1 Tune into the station for which you want to set the volume.
- 2 Adjust the volume to the desired level.
- 3 Hold down the TI VOL ADJ button for two seconds or more. The volume level blinks once in the display to indicate that the data has been stored. Future traffic information/news broadcasts are heard at the preset level.

NOTE

- The volume cannot be lowered by this function during tuner reception. The volume is only set when it is louder than the listening volume of the tuner.
- You can arrange only to listen to traffic information or news bulletins with at preset volume with the volume set at minimum.

CD/External disc control features

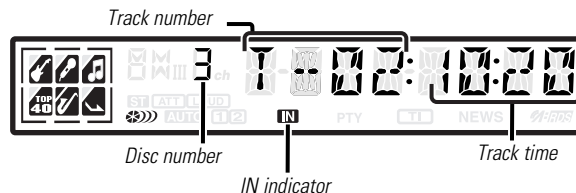
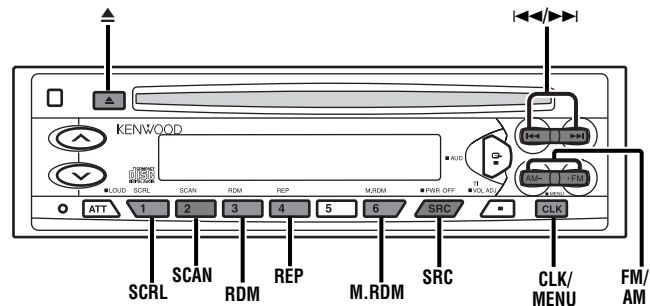

Playing CDs

Playing CDs:

If no CDs are inserted, insert one in the slot with the label facing up.

If a CD is already inserted, press the SRC button repeatedly until the CD mode.

"CD" is displayed when the CD mode has been selected.

The CD will start playing.

The IN indicator lights up when a CD has been inserted.

Stopping and Ejecting CDs:

Press the ▲ button.

The CD stops playing and ejects from the slot.

▲CAUTION

- Do not attempt to insert a CD into the slot if another one is already there.
- The unit can only play 12-cm (5-inch) CDs. If you insert an 8-cm (3-inch) CD, it will get stuck inside and can cause the unit to malfunction.

NOTE

When you load a CD and eject it right away, the next time you try to insert the CD may not load. In such a situation, take the CD out for a moment and then reinsert it.

NOTE

The external disc control mode will differ, depending on the unit that is connected.

Mode display Examples

- "CD2" ...when a CD player is connected
- "DISC" ...when a disc changer is connected
- "DISC-1" , "DISC-2" ...when two disc changers are connected

NOTE

- When one disc has finished playing its last track, the next disc in the changer starts playing. When the last disc in the changer has finished, the player returns to the first disc and starts playing it.
- Disc #10 is displayed as "0".

Function of the KDC-4590R/KDC-4590RV/KDC-4090R

Playing Other Disc mode

This function permits the connection of optional players and the playing of discs other than the loaded CD (in the current unit).

Playing Discs:

Press the SRC button repeatedly to select the external disc control mode.

The disc will start playing.

CD/External disc control features

Switching Display for Discs

Switch the display that appears whilst discs are playing.

Switching Display for Discs:

Each time you press the CLK button, the display during disc play switches as follows:

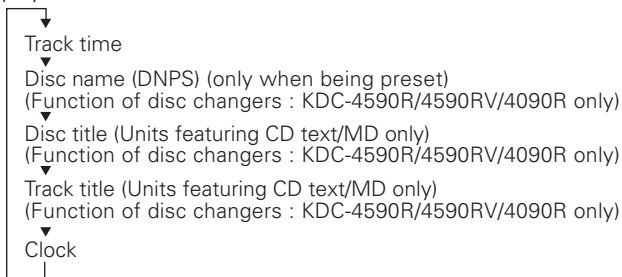

NOTE

- You can give names to discs through the presetting disc name function (page 20).
Note that depending on the unit, display may not be possible.
- If you try to display the name of a disc that does not have one, "NO NAME" is displayed instead.
- When there is an attempt to display the title of a disc for which the disc title/track title has not been recorded, "NO TEXT" is displayed for CD and "NO TITLE/NO NAME" is displayed for MD.
- Depending on the type of characters of the CD Text, some characters may not be displayable.

Fast Forwarding and Reversing Disc Play

Fast Forwarding Disc Play:

Hold down on the ►► button.

Release your finger to play the disc at that point.

Reversing Disc Play:

Hold down on the ◀◀ button.

Release your finger to play the disc at the point.

NOTE

You cannot use reverse play between tracks depending on the model being connected. Instead, the reverse play function is cancelled when it reaches the beginning of a track, at which point normal play automatically resumes.

Track Search

Search forwards or backwards through the tracks on the disc until you reach the one that you want to listen to.

Making a Reverse Track Search:

Press the ◀◀ button to display the desired Track number.

Press once to search back to the beginning of the current track, twice to search back to the beginning of the previous track, and so forth.

Play starts at the beginning of the displayed Track number.

NOTE (For disc changers : KDC-4590R/4590RV/4090R only)

Pressing the ◀◀ button whilst listening to track 1 only searches back to the beginning of that track. The reverse search is not "recycled" to the last track on the disc.

Making a Forward Track Search:

Press the ►► button to display the desired Track number.

Press once to fast forward to the next track, twice to fast forward to the track after that, and so forth.

Play starts at the beginning of the displayed Track number.

NOTE (For disc changers : KDC-4590R/4590RV/4090R only)

You cannot make a forward track search when listening to the last track on a disc.

Disc Search (Function of disc changers)

Search forwards or backwards through the discs in a disc changer until you reach the one that you want to listen to.

Making a Reverse Disc Search:

Press the AM button to display the desired Disc number. Each time the button is pressed, the displayed Disc number decreases by one. Play starts at the beginning of the displayed disc.

Making a Forward Disc Search:

Press the FM button to display the desired Disc number. Each time the button is pressed, the displayed Disc number increases by one. Play starts at the beginning of the displayed disc.

NOTE

"LOAD" is displayed when discs are being exchanged on the disc changer.

Track / Disc Repeat

Repeat playing the current track or disc.

Turning Repeat Play Function On/Off:

Press the REP button to switch the repeat play function on and off as follows :

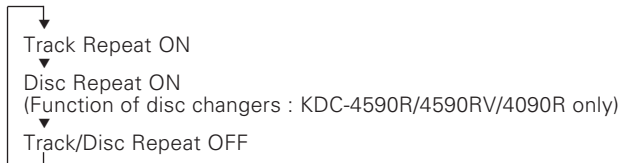

"REP ON"/"TREP ON" is displayed and the Track number blinks in the display when track repeat is on.

"DREP ON" is displayed and the Disc number blinks in the display when disc repeat is on.

NOTE

Repeat play is cancelled when you eject the disc.

Track Scan

Successively play the beginning of each track on a disc until you find the track that you want to listen to.

Starting the Track Scan:

Press the SCAN button. "SCAN ON"/"TSCN ON" is displayed and the first 10 seconds of each track are played, and the tracks are played in order. The Track number currently being heard blinks in the display.

Stopping to Listen to the Track Being Scanned:

Press the SCAN button again to stop the scan and keep on listening to a track normally.

NOTE

- The track scan function is cancelled when you eject the disc.
- The track scan function only scans each track on a disc once.

CD/External disc control features

Random Play

Play all the tracks on the current disc in random order.

- 1 Press the RDM button to switch the random play function on and off.
"RDM ON" is displayed when random play is turned on.
The display of the Track number changes continuously as the next track is being selected.
When the track has been selected, play starts.
The selected Track number blinks in the display as it is being played.

NOTE (For disc changers : KDC-4590R/4590RV/4090R only)

When all the tracks on a certain disc have been played using the random play function, the next disc on the changer starts playing (with the random play function still turned on).

- 2 To change the track being heard, press the ►► button.
Another track is selected and played.

NOTE

Random play is cancelled when you eject the disc.

Function of the KDC-4590R/KDC-4590RV/KDC-4090R

Magazine Random Play (Function of disc changers)

Play the tracks on all the discs in the disc changer in random order.

- 1 Press the M.RDM button to switch the magazine random play function on and off.
"MRDM ON" is displayed when magazine random play is turned on.
The display of the disc and track numbers change continuously as the next track is being selected.
When the disc/track has been selected, play starts.
The selected disc/Track number blinks in the display as it is being played.

- 2 To change the track being heard, press the ►► button.
Another disc/track is selected and played.

NOTE

- Magazine random play is cancelled when you eject the disc.
- The time needed for random selection depends on the number of discs loaded in the disc magazine.

Function of the KDC-4590R/KDC-4590RV/KDC-4090R

Presetting Disc Names (DNPS) (Function of disc changers)

Store the names of discs to be displayed when played.

- 1 Play the disc whose name you want to preset.

NOTE

This function is not available for disc changers that do not feature the Disc Name Preset function.

2 Enter the menu mode

Hold down the MENU button for one second or more. "MENU" is displayed when the menu mode is entered.

- 3 Press the FM or AM button to select the display "NAME SET".

- 4 Hold down either the ◀◀ or ►► button for two seconds or more to enter the disc name preset mode.
The cursor blinks in the position where character input can be made.

- 5 Press either the ◀◀ or ►► button to move the cursor to the desired position.
The ◀◀ button moves the cursor to the left, and the ►► button to the right.

- 6 Press the FM or AM button to display the desired character.
Characters that can be displayed are as follows.
Alphabet (upper case) : A ~ Z
Numerals and symbols : 0~9 @ ' ' % & * + - = , . / \ < > []

- 7 Continue steps 5 and 6 until all the characters are chosen for the name.

NOTE

You can enter up to 8 characters for each name.

8 Assigning Names

Press the MENU button.

The disc name is stored and the Presetting Disc Names mode is ends.

If you make no entry in a 10-second period, the name will be stored with the characters input so far.

NOTE

- The number of discs whose names can be stored will differ depending on the disc changer that is connected. Please see your disc changer manual for details.
- Discs are identified by their total length and number of tracks. If you play another CD that happens to have exactly the same specifications as another CD whose name is stored, the wrong name will be displayed for it.
- If you want to change the name of a disc, repeat steps 1 to 4 to display the name, and then repeat steps 5 and 6 to enter the changes.

*Function of the KDC-4590R/KDC-4590RV/KDC-4090R***Text Scroll***(Function of disc changers)*

This function permits the text to be scrolled and the entire text to be displayed. The scrolling method differs depending on the setting of scrolling in the menu.

To scroll manually:

- 1 Press the CLK button to display the disc title or the track title.
- 2 Pressing the SCRL button results in one scrolling display of the titles.

To scroll automatically:

- 1 Press the CLK button to display the disc title or the track title. The titles will be displayed in one scrolling display.

NOTE

When the disc or track to be played changes, the title is displayed in one scrolling display.

- 2 Pressing the SCRL button results in one scrolling display of the titles.

NOTE

- Please see the menu settings (page 22) about switching between manual scrolling and automatic scrolling.
- Only units with a CD text feature permit title display.

Menu settings

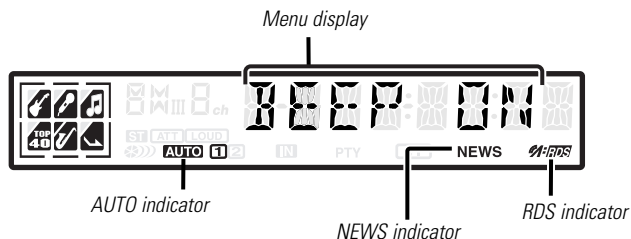
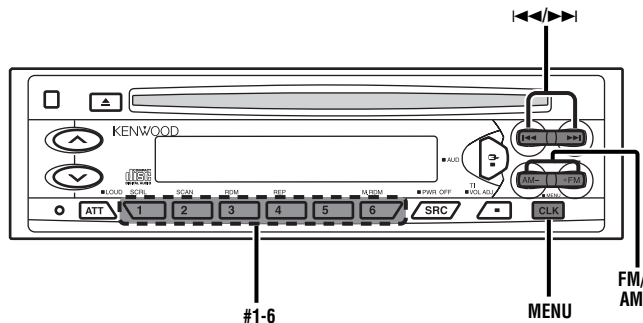

Menu System

You can set the defaults for additional functions in the menu mode. Make a setting for each function, referring to the following operations.

1 Enter the menu mode

Hold down the MENU button for one second or more. "MENU" is displayed when the menu mode is entered. The function that you can adjust is indicated with the current settings displayed.

2 Selecting function to set

Press the FM button to search through the functions until you see the one you want to adjust in the display. Press the AM button to search through the functions backward.

Function items change in the order of features that follow in the menu system.

Example: If you want to switch the setting of the touch sensor tone function from on to off, first search through the functions until you see "BEEP ON" in the display.

3 Changing setting for currently displayed function

Press either the ◀◀ or ▶▶ button.

The setting will change for each function.

Example: The setting of the touch sensor tone will switch from on to off, and "BEEP OFF" is displayed.

4 Ending the menu mode

Press the MENU button.

NOTE

Make sure to end the menu mode when finished.

If you fail to end the menu mode, several functions may not operate properly, including the Traffic Information function, the News Bulletin function with PTY news timeout setting, and the Alarm function.

Touch Sensor Tone

This function produces a beep sound that accompanies button operation. It can be switched on or off.

Display and setting:

"BEEP ON" : Beep setting is on. (Default setting)

"BEEP OFF" : Beep setting is off.

NOTE

The beep sound is not output from the preout jacks.

Manual Time Adjustment

Adjust the time manually.

NOTE

This adjustment is available only when the automatic time adjustment is set to off.

Display and setting:

- 1 Select the display "CLK ADJ" during the selecting function in the menu system.
- 2 Hold down either the ◀◀ or ▶▶ button for two seconds or more to enter the Manual time adjustment mode. The time display will blink.
- 3
 - Adjusting the hours
Press the FM button to advance the hours, or press the AM button to make the hours go back.
 - Adjusting the minutes
Press the ▶▶ button to advance the minutes, or press the ◀◀ button to make the minutes go back.
- 4 Press the MENU button to end the Manual Time Adjustment mode. Exiting the Manual Time Adjustment mode would start the clock counting.

Automatic Time Adjustment

With automatic time adjustment, you can set the clock time automatically according to time data sent from RDS stations (after receiving RDS signals for several minutes). You can also set the time manually if the automatic time adjustment function is turned off.

Display and setting:

"SYNC ON" : Automatic time adjustment (Default setting)

"SYNC OFF" : Manual time adjustment

Adjusting Time Automatically:

Tune into an RDS station for 3 or 4 minutes.

The time adjusts automatically to the correct local time.

NOTE

The time is not adjusted when the RDS station you are tuned to is not transmitting a time signal. Choose another RDS station in such a case.

Disabled System Indicator (DSI)

A red indicator blinks on the unit after the faceplate is removed, warning potential thieves.

Display and setting:

"DSI ON" : The disabled system indicator is on. (Default setting)

"DSI OFF" : The disabled system indicator is off.

Menu settings

Function of the KDC-4590R/KDC-4590RV/KDC-4090R

Selectable Illumination

You can switch the colour of the button illumination between green and red.

Display and setting:

"COL GRN" : The colour of the illumination is green.

"COL RED" : The colour of the illumination is red.

News Bulletin Function with PTY News Timeout Setting

You can arrange to have news bulletins interrupt your current listening source, including other radio stations. When the News Bulletin function is on, the PTY News Timeout setting allows you to set the interval during which further news interruption cannot take place. You can adjust the PTY news interruption period from 10 to 90 minutes for each journey.

Display and setting:

"NEWS OFF" (Default setting) , "NEWS 00M" - "NEWS 90M"
(M= minutes)

: When you select the news interruption timeout interval, the News function turns on and the NEWS indicator lights up.

When a news bulletin is received, "NEWS" will be displayed and reception will begin at the preset volume.

NOTE

- If you choose the "20M" setting, further news bulletins will not be received for 20 minutes once the first news bulletin is received.
- This function is only available if the desired station sends PTY-code for news bulletin or belongs to <Enhanced Other Network>-Network sending PTY-code for news bulletin.
- If you turn on the news bulletin function in the MW/LW band, the band is switched automatically to the FM band. However, the MW/LW band is not returned to when you turn off the function.

Local Seek Function

<In FM reception of Tuner mode>

With the local seek function turned on, auto seek tuning skips stations with relatively poor reception.

Display and setting:

"LO.S ON" : The local seek function is on.

"LO.S OFF" : The local seek function is off. (Default setting)

Selecting Tuning Mode <In Tuner mode>

You can choose from three tuning modes: auto seek, preset station seek, and manual. The "AUTO 1" indicator lights up when auto seek tuning is selected, and the "AUTO 2" indicator lights when preset station seek tuning is selected.

Display and setting:

"AUTO 1" : Auto seek tuning mode (Default setting)

"AUTO 2" : Preset station seek tuning mode

"MANUAL" : Manual tuning mode

Auto Memory Entry <In Tuner mode>

You can automatically store all the receivable frequencies in the band currently being listened to, and then recall them with the touch of a button later. This function is especially useful when you are travelling and do not know what stations are available. Up to 6 frequencies can be stored this way.

Display and setting:

- 1 Select the display "A-MEMORY" during the selecting function in the menu system.
- 2 Hold down either the ◀◀ or ▶▶ button for two seconds or more to start auto memory function.
The numbers of the preset station buttons showed in order.

When all the stations in a certain band are stored in the preset memory, the auto memory entry stops. The tuner then plays the last station received.

NOTE

- When the AF function is turned on whilst auto memory entry takes place, only RDS stations (i.e., stations with RDS capability) are stored. RDS stations that have been preset for FM1 cannot also be preset in FM2 or FM3.
- When the local seek function is turned whilst auto memory entry takes place, stations with poor reception are not stored.
- When the Traffic Information function is on, only the local traffic information station frequency will be stored.

Cancelling Auto Memory Entry During Its Operation:

Press the MENU button whilst auto memory entry is taking place to stop the process.

Recalling a Preset Station:

Press the preset station button (#1-6) for the desired station. The number of the recalled station is displayed.

AF (Alternative Frequency) Function

When poor reception is experienced, automatically switch to another frequency broadcasting the same programme in the same RDS network with better reception. The RDS indicator lights up when the AF function is turned on.

Display and setting:

"AF ON" : The AF function is on. (Default setting)

"AF OFF" : The AF function is off.

NOTE

When no other stations with stronger reception are available for the same programme in the RDS network, you may hear the incoming broadcast in bits and snatches. Turn off the AF function in such a case.

Restricting RDS Region (Region Restrict Function)

You can choose whether or not to restrict the RDS channels, received with the AF function for a particular network, to a specific region. When the Region Restrict Function is on, the region is restricted.

Display and setting:

"REG ON" : The Region Restrict Function is on. (Default setting)

"REG OFF" : The Region Restrict Function is off.

NOTE

Sometimes stations in the same network broadcast different programmes or use different programme service names.

Auto TP Seek Function

When the TI function is on and poor reception conditions are experienced when listening to a traffic information station, another traffic information station with better reception will be searched for automatically. This function is on, when unit is first powered on.

Display and setting:

"ATPS ON" : The Auto TP Seek Function is on.

If the traffic information station you are tuned to experiences poor reception, this function automatically seeks another TP station. (Default setting)

"ATPS OFF" : The Auto TP Seek Function is off.

Menu settings

Monaural Reception <In FM reception of Tuner mode>

When poor stereo reception is experienced, this function will reduce noise and improve listening conditions.

Display and setting:

- "MONO ON" : The monaural reception is on.
- "MONO OFF" : The monaural reception is off. (Default setting)

Function of the KDC-4590R/KDC-4590RV/KDC-4090R

Text Scroll <In External disc control mode>

This function permits the CD text and MD title to be scrolled and the entire text to be displayed. Switching between manual scrolling and automatic scrolling is permitted.

Display and setting:

- "SCL AUTO" : Automatic scrolling
- "SCL MANU" : Manual scrolling (Default setting)

Function of the KDC-4590R/KDC-4590RV/KDC-4090R

Name Preset

This function allows you to assign the name to be displayed for the currently playing disc.
See the next page for the name presetting method.

Presetting Disc Names (DNPS) : page 20



Power OFF Timer

Set the time for the OFF Timer function activated when you selected Standby mode.
If the predefined time elapses, this unit's power is automatically turned off.

Display and setting:

- "OFF -- --" : Power OFF Timer function is cancelled.
- "OFF 20M" : Unit's power goes OFF after 20 minutes. (Default setting)
- "OFF 40M" : Unit's power goes OFF after 40 minutes.
- "OFF 60M" : Unit's power goes OFF after 60 minutes.

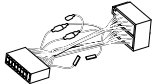
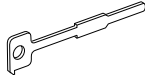
Accessories

	External view	Number of items
①	1
②	2
③	1

▲CAUTION

The use of any accessories except for those provided might result in damage to the unit. Make sure only to use the accessories shipped with the unit, as shown above.

Installation Procedure

1. To prevent short circuits, remove the key from the ignition and disconnect the ⊖ terminal of the battery.
2. Make the proper input and output cable connections for each unit.
3. Connect the cable on the wiring harness.
4. Take Connector B on the wiring harness and connect it to the speaker connector in your vehicle.
5. Take Connector A on the wiring harness and connect it to the external power connector on your vehicle.
6. Connect the wiring harness connector to the unit.
7. Install the unit in your car.
8. Reconnect the ⊖ terminal of the battery.
9. Press the reset button.

▲CAUTION

- If your car is not prepared for this special connection-system, consult your Kenwood dealer.
- Only use antenna conversion adapters (ISO-JASO) when the antenna cord has an ISO plug.
- Make sure that all cable connections are securely made by inserting jacks until they lock completely.
- If your vehicle's ignition does not have an ACC position, or if the ignition cable is connected to a power source with constant voltage such as a battery cable, the power will not be linked with the ignition (i.e., it will not turn on and off along with the ignition). If you want to link the unit's power with the ignition, connect the ignition cable to a power source that can be turned on and off with the ignition key.
- If the fuse blows, first make sure that the cables have not caused a short circuit, then replace the old fuse with one with the same rating.
- Do not let unconnected cables or terminals touch metal on the car or anything else conducting electricity. To prevent short circuits, also do not remove the caps on the ends of the unconnected cables or the terminals.
- Connect the speaker cables correctly to the terminals to which they correspond. The unit may receive damage or fail to work if you share the ⊖ cables and/or ground them to any metal part in the car.
- After the unit is installed, check whether the brake lamps, indicators, wipers, etc. on the car are working properly.
- Insulate unconnected cables with vinyl tape or other similar material.
- Some disc changers need conversion cables for connection. See the section on "Safety Precautions" for details.
- If the console has a lid, make sure to install the unit so that the faceplate does not hit the lid when closing and opening.
- Mount the unit so that the mounting angle is 30° or less.

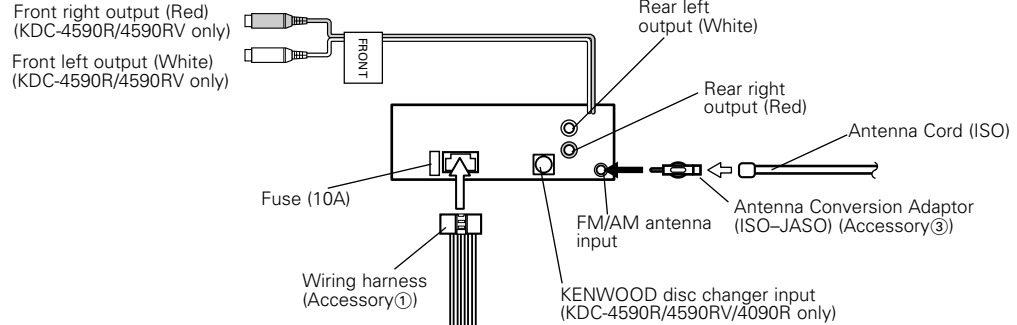

NOTE

To connect the Disc changer, consult your Disc changer manual.

*1 KDC-4590R/4090R/3090RA/3090RG/305RA/305RG : Battery cable (Yellow)
 *2 KDC-4590RV : Ignition cable (Red)

*1 KDC-4590R/4090R/3090RA/3090RG/305RA/305RG : Ignition cable (Red)
 *2 KDC-4590RV : Battery cable (Yellow)

Connect to the terminal that is grounded when either the telephone rings or during conversation.

NOTE

To connect the KENWOOD navigation system, consult your navigation manual.

If no connections are made, do not let the cable come out from the tab.

Connect either to the power control terminal when using the optional power amplifier, or to the antenna control terminal in the vehicle.

Connector Function Guide

Pin Numbers for ISO Connectors	Cable Colour	Functions
External Power Connector		
A-4	Yellow	Battery* ¹
A-5	Blue/White	Ignition (ACC)* ²
A-7	Red	Power Control
A-8	Black	Ignition (ACC)* ¹
A-8	Black	Battery* ²
A-8	Black	Earth (Ground) Connection
Speaker Connector		
B-1	Purple	Rear Right (+)
B-2	Purple/Black	Rear Right (-)
B-3	Gray	Front Right (+)
B-4	Gray/Black	Front Right (-)
B-5	White	Front Left (+)
B-6	White/Black	Front Left (-)
B-7	Green	Rear Left (+)
B-8	Green/Black	Rear Left (-)

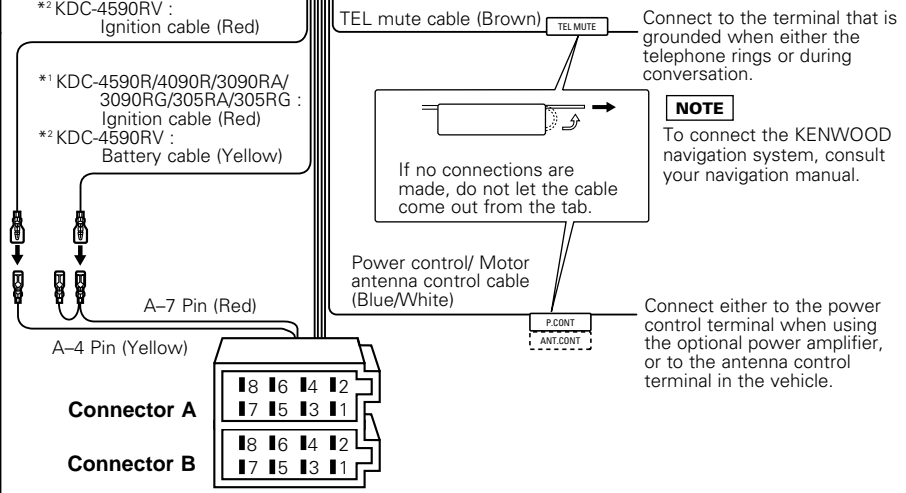

Connecting Cables to Terminals

⚠ WARNING Connecting the ISO Connector (see p.28)

The pin arrangement for the ISO connectors depends on the type of vehicle you drive. Make sure to make the proper connections to prevent damage to the unit.

The default connection for the wiring harness is described in **1** below. If the ISO connector pins are set as described in **2** or **3**, make the connection as illustrated.

- 1** (Default setting) The A-7 pin (red) of the vehicle's ISO connector is linked with the ignition, and the A-4 pin (yellow) is connected to the constant power supply.

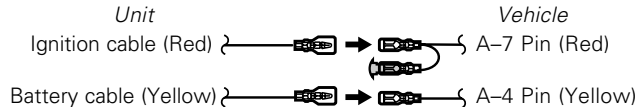

- 2** The A-7 pin (red) of the vehicle's ISO connector is connected to the constant power supply, and the A-4 pin (yellow) is linked to the ignition.

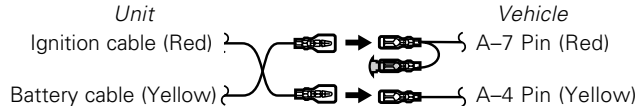

- 3** The A-7 pin (red) of the vehicle's ISO connector is not connected to anything, whilst the A-4 pin (yellow) is connected to the constant power supply (or both the A-7 (red) and A-4 (yellow) pins are connected to the constant power supply).

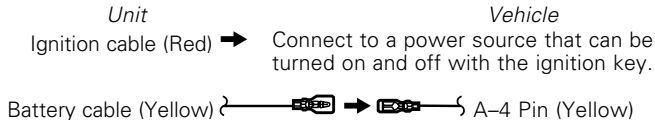

Installation

■ Installation

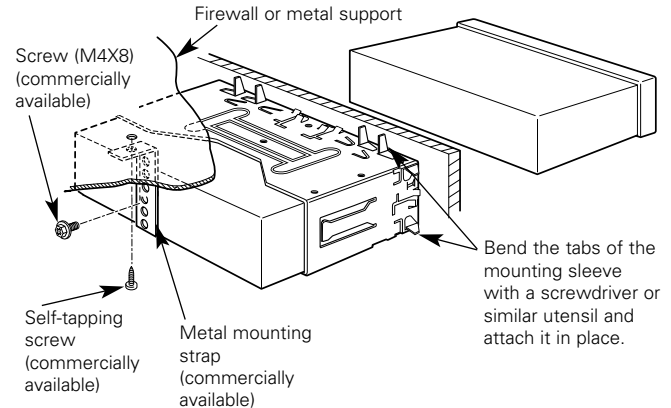

NOTE

Make sure that the unit is installed securely in place. If the unit is unstable, it may malfunction (eg, the sound may skip).

Installation

■ Removing the hard rubber frame

- Engage the catch pins on the removal tool and remove the two locks on the lower level.
Lower the frame and pull it forward as shown in the figure.

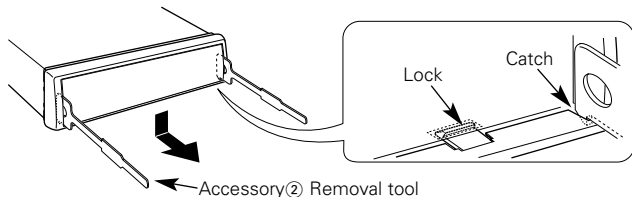

- When the lower level is removed, remove the upper two locations.

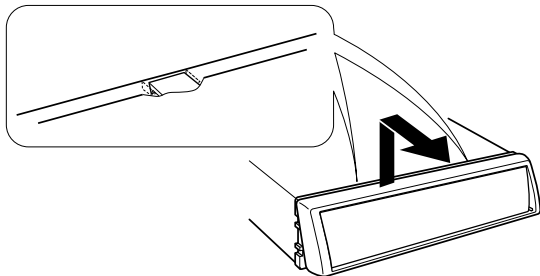

NOTE

The frame can be removed from the top side in the same manner.

■ Removing the Unit

- Refer to the section "Removing the hard rubber frame" and then remove the hard rubber frame.
- Remove the screw (M4x8) on the back panel.
- Insert the two removal tools deeply into the slots on each side, as shown.

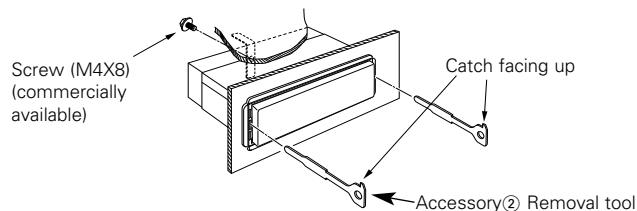

- Lower the removal tool toward the bottom, and pull out the unit halfway whilst pressing towards the inside.

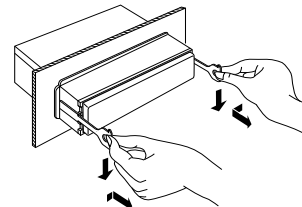

CAUTION

Be careful to avoid injury from the catch pins on the removal tool.

- Pull the unit all the way out with your hands, being careful not to drop it.

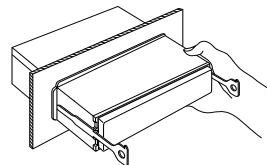

Troubleshooting Guide

What might appear to be a malfunction in your unit may just be the result of slight misoperation or miswiring. Before calling service, first check the following table for possible problems.

PROBLEM	POSSIBLE CAUSE	SOLUTION
The power does not turn on.	The fuse has blown.	After checking for short circuits in the cables, replace the fuse with one having the same rating.
	No ACC position on vehicle ignition.	Connect the same cable to the ignition as the battery cable.
If you have selected Standby mode, the power will go OFF automatically.	The Power Off Timer function has been activated.	If you do not want the power to go OFF automatically, cancel the Power Off Timer function.
No sound can be heard, or the volume is low.	The Attenuator function is turned on.	Turn off the Attenuator function.
	The fader and/or balance settings are set all the way to one side.	Reset the fader and/or balance settings.
	The input/output cables or wiring harness are connected incorrectly.	Reconnect the input/output cables and/or the wiring harness correctly. See the section on "Connecting Cables to Terminals".
Nothing happens when the buttons are pressed.	The computer chip in the unit is not functioning normally.	Press the reset button on the unit (see page 4).
The sound quality is poor or distorted.	A speaker cable may be pinched by a screw in the car.	Check the speaker wiring.
	The speakers are not wired correctly.	Reconnect the speaker cables so that each output terminal is connected to a different speaker.
Radio reception is poor.	The car antenna is not extended.	Pull out the antenna all the way.
	The antenna control cable is not connected.	Connect the cable correctly, referring to the section on "Connecting Cables to Terminals".
The memory is erased when the ignition is turned off.	The battery cable has not been connected to the proper terminal.	Connect the cable correctly, referring to the section on "Connecting Cables to Terminals".
	The ignition and battery cable are incorrectly connected.	Connect the cable correctly, referring to the section on "Connecting Cables to Terminals".
The TEL mute function does not work.	The TEL mute cable is not connected properly.	Connect the cable correctly, referring to the section on "Connecting Cables to Terminals".
The TEL mute function turns on even though the TEL mute cable is not connected.	The TEL mute cable is touching a metal part of the car.	Pull the TEL mute cable away from the metal part of the car.

PROBLEM	POSSIBLE CAUSE	SOLUTION
A CD ejects as soon as it is loaded.	The CD is upside-down.	Load the CD with the labelled side up.
	The CD is quite dirty.	Clean the CD, referring to the section on "Cleaning CDs" (see page 5).
The sound skips on a CD.	The CD is scratched or dirty.	Clean the CD, referring to the section on "Cleaning CDs" (see page 5).
The specified track does not play.	Random play has been selected.	Turn off the random play function.
Can't remove disc.	The cause is that more than 10 minutes has elapsed since the vehicle ACC switch was turned OFF.	The disc can only be removed within 10 minutes of the ACC switch being turned OFF. If more than 10 minutes has elapsed, turn the ACC switch ON again and press the Eject button.
Free switching of the sound quality.	The System Q function is set on Scan mode.	Refer to the "System Q" page and switch it to a function other than Scan mode. (see page 8)

CD/External disc control mode

PROBLEM	POSSIBLE CAUSE	SOLUTION
The disc control mode cannot be selected.	No cable has been connected to the disc changer input terminal on the unit.	Connect the cable to the disc changer input terminal on the unit.
The specified disc does not play, but another one plays instead.	The specified CD is very dirty.	Clean the CD.
	The CD is upside-down.	Load the CD with the labelled side up.
	The disc is loaded in a different slot from that specified.	Eject the disc magazine and check the number for the specified disc.
	The disc is severely scratched.	Try another disc instead.
The sound skips.	Something is touching the disc changer.	Remove whatever is touching it.
	The CD is scratched or dirty.	If skipping happens at the same place when the car is stopped, something is wrong with the CD. Clean the CD.
The display shows that the changer is being played, but no sound can be heard.	The computer chip in the unit is not functioning normally.	Press the reset button on the unit (see page 4).
The specified track does not play.	Random play or magazine random play has been selected.	Turn off the random play or magazine random play function.
Track repeat, disc repeat, track scan, random play, and magazine random play start by themselves.	The setting is not cancelled.	The settings for these functions remain on until the setting to off or the disc ejected, even if the power is turned off or the source changed.
Cannot play CD-R or CD-RW.	Finalization processing is not being conducted for CD-R/CD-RW.	Conduct finalization processing with CD recorder.
	A non-compatible CD changer is being used to play the CD-R/CD-RW.	Use a CD changer compatible with CD-R/CD-RW to play.

If the following situations, consult your nearest service centre:

- Even though the disc changer is connected, the Disc Changer Mode is not on, with "AUX" showing in the display during the Changer Mode.
- Even though no device (KCA-S210A, CA-C1AX, KDC-CPS87, KDC-CX87, KDC-CPS85, KDC-CX85, KDC-CPS82 or KDC-CX82) is connected, the AUX Mode is entered when switching modes.

The following messages are displayed when certain problems are occurring in your system. Take the recommended actions.

EJECT	No disc magazine has been loaded in the changer. The disc magazine is not completely loaded. ⇒ Load the disc magazine properly. No CD in the unit. ⇒ Insert the CD.
NO DISC	No disc has been loaded in the disc magazine. ⇒ Load a disc into the disc magazine.
E-04	No disc has been loaded in the disc magazine. ⇒ Load a disc into the disc magazine. The CD is very dirty. The CD is upside-down. The CD is scratched a lot. ⇒ Clean the CD and load it correctly.
BLANK	Nothing has been recorded on the MD.
NO TRACK	No tracks are recorded on the MD, although it has a title.
NO PANEL	The faceplate of the slave unit being connected to this unit has been removed. ⇒ Replace it.
E-77	The unit is malfunctioning for some reason. ⇒ Press the reset button on the unit. If the "E- 77", code does not disappear, consult your nearest service centre.
E-99	Something is wrong with the disc magazine. Or the unit is malfunctioning for some reason. ⇒ Check the disc magazine. And then, press the reset button on the unit. If the "E- 99" code does not disappear, consult your nearest service centre.
HOLD	The protective circuit in the unit activates when the temperature inside the automatic disc changer exceeds 60°C (140°F), stopping all operation. ⇒ Cool down the unit by opening the windows or turning on the air conditioner. As the temperature falls below 60°C (140°F), the disc starts playing again.
IN	If this indicator blinks, the CD player is malfunctioning. ⇒ Eject the CD and try inserting it again. If the CD cannot be ejected, press the eject button and hold it in until the CD is ejected.

Specifications

Specifications subject to change without notice.

FM tuner section

Frequency range (50 kHz space)	87.5 MHz – 108.0 MHz
Usable sensitivity (S/N = 26dB)	0.7 μ V/75 Ω
Quieting Sensitivity (S/N = 46dB)	1.6 μ V/75 Ω
Frequency response (\pm 3.0 dB)	30 Hz – 15 kHz
Signal to Noise ratio (MONO)	65 dB
Selectivity (DIN) (\pm 400 kHz)	\geq 80 dB
Stereo separation (1 kHz)	35 dB

MW tuner section

Frequency range (9 kHz space)	531 kHz – 1611 kHz
Usable sensitivity (S/N = 20dB)	25 μ V

LW tuner section

Frequency range	153 kHz – 281 kHz
Usable sensitivity (S/N = 20dB)	45 μ V

CD player section

Laser diode	GaAlAs (λ =780 nm)
Digital filter (D/A)	8 Times Over Sampling
D/A Converter	1 Bit
Spindle speed	500 – 200 rpm (CLV)
Wow & Flutter	Below Measurable Limit
Frequency response (\pm 1 dB)	10 Hz – 20 kHz
Total harmonic distortion (1 kHz)	0.01 %
Signal to Noise ratio (1 kHz)	96 dB
Dynamic range	93 dB
Channel separation	85 dB

Audio section

Maximum output power	45 W \times 4
Full Bandwidth Power (DIN 45324, +B=14.4V)	28 W \times 4
Tone action	
Bass :	100 Hz \pm 10 dB
Middle :	1 kHz \pm 10 dB
Treble :	10 kHz \pm 10 dB
Preout level / Load (during disc play)	1800 mV/10 k Ω
Preout impedance (during disc play)	\leq 600 Ω

General

Operating voltage (11 – 16V allowable)	14.4 V
Current consumption	10 A
Installation Size (W x H x D)	182 \times 53 \times 157 mm
Weight	3.31 lbs (1.5 kg)

KENWOOD