

# KENWOOD

**KDC-4015**

**KDC-415S**

**KDC-315V**

**KDC-315S**

**KDC-215S**

**KDC-35MR**

CD-RECEIVER

## **INSTRUCTION MANUAL**

KENWOOD CORPORATION

**Take the time to read through this instruction manual.  
Familiarity with installation and operation procedures will help  
you obtain the best performance from your new CD-receiver.**

### **For your records**

Record the serial number, found on the back of the unit, in the spaces designated on the warranty card, and in the space provided below.

Refer to the model and serial numbers whenever you call upon your KENWOOD dealer for information or service on the product.

Model KDC-4015/415S/315V/315S/215S/35MR

Serial number \_\_\_\_\_

©B64-1546-10 (KW)

**COMPACT**  
**disc**  
**DIGITAL AUDIO**

## Contents

### **Before use**

Warning .....	3
Safety precautions .....	4
Handling Compact discs .....	6

### **General features**

Power .....	7
Volume .....	7
Attenuator .....	7
Switching Modes .....	8
Loudness .....	8
Audio Control Setting .....	8
ec4/dB (Sound Coordinate) .....	9
Mobile Preset .....	9
Theft Deterrent Faceplate .....	10
Clock display .....	10
Adjusting Time .....	10

### **Tuner features**

Tuning .....	11
Station Preset Memory .....	12
Auto Memory Entry .....	12
Clean Reception System Circuit (CRSC) .....	12

### **CD/External disc control features**

Playing CDs .....	13
Playing Other Disc mode .....	14
Fast Forwarding and Reversing Disc Play .....	14
Track Search .....	14
Disc Search .....	14
Track / Disc Repeat .....	15
Track Scan .....	15
Disc Scan .....	15
Random Play .....	16
Magazine Random Play .....	16

### **Basic Operations of remote ..... 17**

#### **Installation**

Accessories .....	19
Installation Procedure .....	19
Connecting Wires to Terminals .....	20
Installation .....	21

### **Troubleshooting Guide ..... 24**

### **Specifications ..... 27**

## **▲ Warning**

---

### **▲ CAUTION**

Use of controls or adjustments or performance of procedures other than those specified herein may result in hazardous radiation exposure.

In compliance with Federal Regulations, following are reproductions of labels on, or inside the product relating to laser product safety.

KENWOOD CORPORATION  
2967-3, ISHIKAWA-CHO,  
HACHIOJI-SHI  
TOKYO, JAPAN

KENWOOD CORP. CERTIFIES THIS EQUIPMENT  
CONFORMS TO DHHS REGULATIONS NO.21 CFR  
1040. 10, CHAPTER 1, SUBCHAPTER J.

Location : Bottom Panel

### **FCC WARNING**

This equipment may generate or use radio frequency energy. Changes or modifications to this equipment may cause harmful interference unless the modifications are expressly approved in the instruction manual. The user could lose the authority to operate this equipment if an unauthorized change or modification is made.

### **NOTE**

This equipment has been tested and found to comply with the limits for a Class B digital device, pursuant to Part 15 of the FCC Rules. These limits are designed to provide reasonable protection against harmful interference in a residential installation. This equipment may cause harmful interference to radio communications, if it is not installed and used in accordance with the instructions. However, there is no guarantee that interference will not occur in a particular installation. If this equipment does cause harmful interference to radio or television reception, which can be determined by turning the equipment off and on, the user is encouraged to try to correct the interference by one or more of the following measures:

- Reorient or relocate the receiving antenna.
- Increase the separation between the equipment and receiver.
- Connect the equipment into an outlet on a circuit different from that to which the receiver is connected.
- Consult the dealer or an experienced radio/TV technician for help.

### **NOTE**

This Class B digital apparatus complies with Canadian ICES-003.

## Safety precautions

### ▲WARNING

#### **To prevent injury or fire, take the following precautions:**

- Insert the unit all the way in until it is fully locked in place. Otherwise it may fall out of place when jolted.
- When extending the ignition, battery, or ground wires, make sure to use automotive-grade wires or other wires with a 0.75mm<sup>2</sup> (AWG18) or more to prevent wire deterioration and damage to the wire coating.
- To prevent a short circuit, never put or leave any metallic objects (such as coins or metal tools) inside the unit.
- If the unit starts to emit smoke or strange smells, turn off the power immediately and consult your Kenwood dealer.
- Make sure not to get your fingers caught between the faceplate and the unit.
- Be careful not to drop the unit or subject it to strong shock.  
The unit may break or crack because it contains glass parts.
- Do not touch the liquid crystal fluid if the LCD is damaged or broken due to shock. The liquid crystal fluid may be dangerous to your health or even fatal.  
If the liquid crystal fluid from the LCD contacts your body or clothing, wash it off with soap immediately.

### ▲CAUTION

#### **To prevent damage to the machine, take the following precautions:**

- Make sure to ground the unit to a negative 12V DC power supply.
- Do not open the top or bottom covers of the unit.
- Do not install the unit in a spot exposed to direct sunlight or excessive heat or humidity. Also avoid places with too much dust or the possibility of water splashing.
- Do not set the removed faceplate or the faceplate case in areas exposed to direct sunlight, excessive heat or humidity. Also avoid places with too much dust or the possibility of water splashing.
- To prevent deterioration, do not touch the terminals of the unit or faceplate with your fingers.
- Do not subject the faceplate to excessive shock, as it is a piece of precision equipment.
- When replacing a fuse, only use a new one with the prescribed rating. Using a fuse with the wrong rating may cause your unit to malfunction.
- To prevent a short circuit when replacing a fuse, first disconnect the wiring harness.
- Do not place any object between the faceplate and the unit.
- Do not use your own screws. Use only the screws provided. If you use the wrong screws, you could damage the unit.

### IMPORTANT INFORMATION

*You cannot connect the unit directly to the following CD automatic changers. If you want to use older changers with the unit, follow the directions below according to the type of changer you own:*

#### • **KDC-C200 / KDC-C300 / KDC-C400**

Use the extension cable and the control box attached to the CD changer, and the optional CA-DS100 converter cord.

#### • **KDC-C301 / KDC-C600 / KDC-C800 / KDC-C601 / KDC-C401**

Use the extension cable attached to the CD changer, and the optional CA-DS100 converter cord.

#### • **KDC-C100 / KDC-C302 / C205 / C705 / non-Kenwood CD changers**

Cannot be used with this model.

### ▲CAUTION

***You can damage both your unit and the CD changer if you connect them incorrectly.***

## NOTE

- If you experience problems during installation, consult your Kenwood dealer.
- If the unit does not seem to be working right, try pressing the reset button first. If that does not solve the problem, consult your Kenwood dealer.

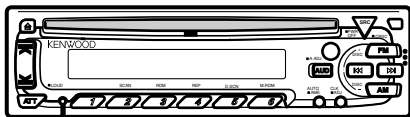

Reset button

- Characters in the LCD may become difficult to read in temperatures below 41 °F (5 °C).
- The illustrations of the display and the panel appearing in this manual are examples used to explain more clearly how the controls are used. Therefore, what appears on the display in the illustrations may differ from what appears on the display on the actual equipment, and some of the illustrations on the display may represent something impossible in actual operation.
- The functions that can be used and the information that can be displayed will differ depending on the external disc players being connected.

## ***Cleaning the Faceplate Terminals***

If the terminals on the unit or faceplate get dirty, wipe them with a dry, soft cloth.

## ***Cleaning the Unit***

If the front panel gets dirty, turn off the power and wipe the panel with a dry silicon cloth or soft cloth.

## **CAUTION**

Do not wipe the panel with a hard cloth or a cloth dampened by volatile solvents such as paint thinner and alcohol. They can scratch the surface of the panel and/or cause the indicator letters to peel off.

## ***Cleaning the CD Slot***

As dust tends to accumulate in the CD slot, clean it every once in a while. Your CDs can get scratched if you put them in a dusty CD slot.

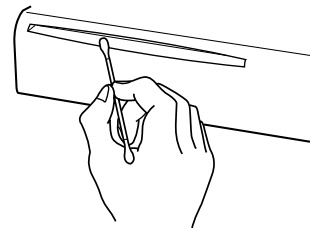

## ***Lens Fogging***

Right after you turn on the car heater in cold weather, dew or condensation may form on the lens in the CD player of the unit. Called lens fogging, CDs may be impossible to play. In such a situation, remove the disc and wait for the condensation to evaporate. If the unit still does not operate normally after a while, consult your Kenwood dealer.

## **CAUTION**

### ***Do Not Load 3-in. CDs in the CD slot***

If you try to load a 3 in. CD with its adapter into the unit, the adapter might separate from the CD and damage the unit.

## Handling Compact discs

**Playing a CD that is dirty, scratched or warped can cause the sound to skip and the unit to operate incorrectly, resulting in worsened sound quality. Take the following precautions to prevent your CDs from getting scratched or damaged.**

### Handling CDs

- Do not touch the recorded side of the CD (the side opposite the label) when holding it.

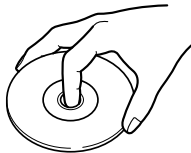

- Do not stick tape on either side of the CD.

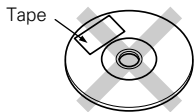

### Storing CDs

- Do not store CDs in areas exposed to direct sunlight (such as a car seat or the dashboard) or other hot places.
- Remove CDs from the unit when not listening to them for a while, and put them back in their cases. Do not pile up CDs that are removed from their cases or prop them against something.

### Cleaning CDs

If a CD has gotten dirty, wipe it off gently using a commercially available cleaning cloth or a soft cotton cloth, starting from the center of the disc and moving outward. Do not clean CDs with conventional record cleaners, anti-static formulas, or chemicals such as paint thinner or benzene.

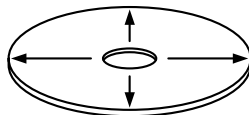

### Checking New CDs for Burrs

When playing a new CD for the first time, check that there are not any burrs stuck to the perimeter of the disc or in the central hole. CDs with burrs stuck on them may not load properly or may skip while playing. Remove burrs using a ballpoint pen or a similar utensil.

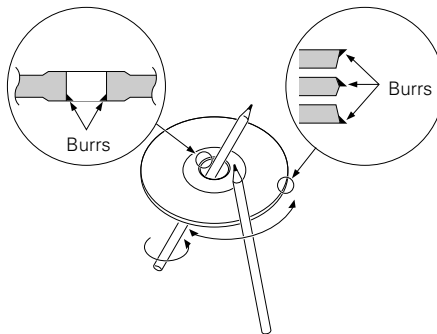

### Do Not Load CD Accessories

Do not use commercially available CD accessories that can be loaded into the CD slot, such as stabilizers, protective sheets, or CD cleaning discs, since they can cause the unit to malfunction.

### Removing the CD

Only remove the CD from the machine in a horizontal direction, holding it flat. You may damage the surface of the CD if you try pulling it down as it ejects.

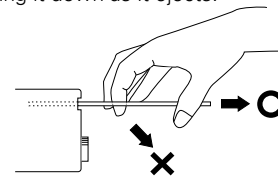

### Do Not Use Special Shape CDs

- Be sure to use round shape CDs only for this unit and do not use any special shape CDs. Use of special shape CDs may cause the unit to malfunction.



- Be sure to use CDs with disc mark  only for this unit.

### Do Not Use CDs with Sticker on the Labeled Side

Do not use the CD with the label sticker stuck on it. Using such a CD may cause the CD to be deformed and the sticker to peel off, resulting in malfunction of the unit.

## General features

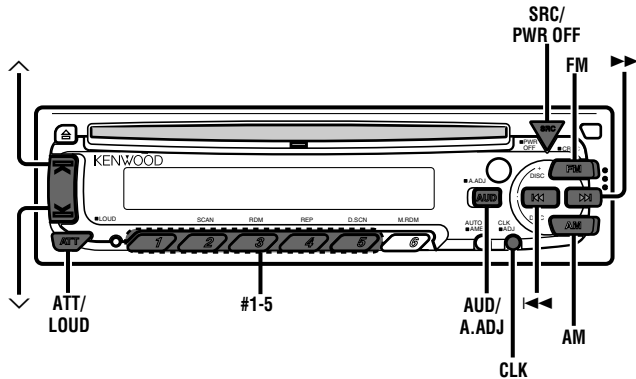

ATT indicator

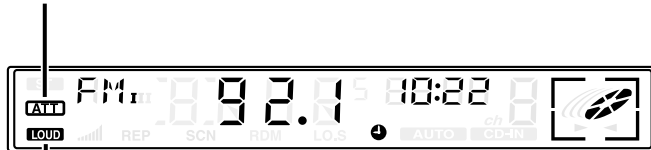

LOUD indicator

### Power

#### Turning on the power:

Press the SRC (source) button.

#### NOTE

Turn the power on before carrying out the following procedures.

#### Turning off the power:

Press the PWR OFF button for at least one second.

### Volume

#### Increasing Volume:

Press the  $\wedge$  button to turn up the volume.

#### Decreasing Volume:

Press the  $\vee$  button to turn down the volume.

### Attenuator

This function allows you to turn down the volume quickly.

#### Turning Attenuator On/Off:

Press the ATT button to switch the attenuator on and off.

When the attenuator is on, the ATT indicator blinks.

When the attenuator is off, the volume returns to the original level.

#### NOTE

Turning the volume up, or turning it all the way down deactivates the attenuator function.

## General features

### Switching Modes

#### Switching Modes:

Each time you press the SRC (source) button, the mode switches as follows:

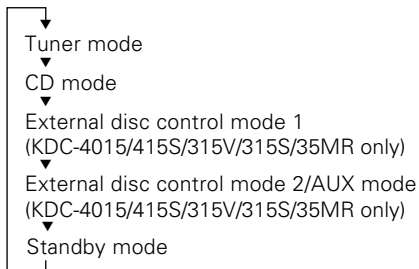

#### Selecting standby mode:

Press the SRC button repeatedly and switch to "OFF". When "OFF" is displayed, the standby mode is activated. The standby mode turns all functions off while leaving the power to the unit on. Use this mode when you want to have the display illuminated but don't want to listen to anything.

#### NOTE

- The mode switches to the next mode from any mode which cannot be used.
- The external disc control mode will differ depending on the unit that is connected.
- The AUX mode is available only when the changer / AUX switching adapter (KCA-S210A or CA-C1AX) or CD changer (KDC-CPS85, KDC-CX85, KDC-CPS82 or KDC-CX82) is connected to this unit.  
During the AUX mode, "AVin" will show in the display. When the CA-C1AX is being used, the AUX Mode will replace the External Disc Control Mode.

### Loudness

This function amplifies low and high tones when the volume is

turned down.  
The LOUD indicator lights up when the loudness function is on.

#### Turning Loudness On/Off:

Press the LOUD button for at least one second to switch the loudness on and off.

### Audio Control Setting

Adjust various parameters of sound quality.

- 1 Press the A.ADJ button for at least one second to enter the control mode.
- 2 **Selecting mode**  
Press either the FM or AM button.  
Each time the button is pressed, the adjustment mode will change.  
Please refer to the following for the contents of the adjustment modes.

#### NOTE Source tone memory

Each source ( CD, FM, AM and disc changer ) has its own memory in which to store the bass and treble tone settings. The settings made for a particular source are recalled automatically whenever you use that source ( for example, FM mode uses the tone settings made for FM, AM for AM, etc.).

- 3 **Adjust each mode**  
Press the ◀◀/▶▶ button.  
Please refer to the following for the adjusting values.
- 4 Press the A.ADJ button to end the control mode.

#### "BAS": Adjust the bass level.

Setting values: - 8 - + 8



**"TRE": Adjust the treble level.**

Setting values: - 8 - + 8

**"BL": Adjust the balance level.**

Setting values: Left 15 - Right 15

**"FD": Adjust the fader level.**

Setting values: Front 15 - Rear 15

**ec4/dB (Sound Coordinate)**

You can recall the best audio setting preset for different types of the music.

- 1 Press the AUD button to enter the Sound Coordinate mode.
- 2 Press a preset button (#1-5).  
The preset settings of the bass and treble tones are recalled.  
#1: Flat  
#2: Rock  
#3: Top 40  
#4: Jazz  
#5: Easy
- 3 Press the AUD button to end the sound coordinate mode.

**NOTE**

You can call the following settings with this function; bass center frequency, bass level, bass quality factor, bass extension, treble center frequency, and treble level setting.

**Mobile Preset**

This function allows you to adjust the setting that is recalled with the sound coordinate system, according to types of speakers.

- 1 Press the SRC button repeatedly to select the standby mode. "OFF" is displayed when the standby mode is selected.
- 2 Press the AUD button to enter the mobile preset plan mode.
- 3 Press either the ◀◀ or ▶▶ button to select the type of speaker. The setting switches as follows.  
Flat / For the OEM speaker / For 6x9 in. speaker / For 5 in. speaker
- 4 Press the AUD button to end the mobile preset plan mode.

**NOTE**

When you change the setting of type of speaker, the bass and treble tone settings are returned to original levels.

## General features

### Theft Deterrent Faceplate

The faceplate of the unit can be detached and taken with you, helping to deter theft.

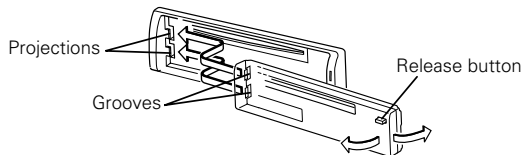

#### Removing the Faceplate:

Press the release button.

The faceplate is unlocked, allowing you to detach it.

#### NOTE

- The faceplate is a precision piece of equipment and can be damaged by shocks or jolts. For that reason, keep the faceplate in its special storage case while detached.

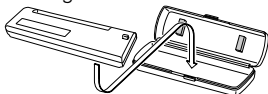

- Do not expose the faceplate or its storage case to direct sunlight or excessive heat or humidity. Also avoid places with too much dust or the possibility of water splashing.

#### Reattaching the Faceplate:

- 1 Align the projections on the unit with the grooves on the faceplate.
- 2 Push the faceplate in until it clicks.  
The faceplate is locked in place, allowing you to use the unit.



### Clock display

#### Turning clock display On/Off:

Press the CLK button to switch the clock display on and off. The  indicator lights while the clock is displayed.

### Adjusting Time

Adjust the time.

- 1 When the time is not displayed, first press the CLK button to display the time.
- 2 Press the CLK button for at least two seconds to enter the clock adjustment mode. The time display will blink.
- 3 • Adjusting the hours  
Press the FM button to advance the hours, or press the AM button to make the hours go back.  
• Adjusting the minutes  
Press the  button to advance the minutes, or press the  button to make the minutes go back.
- 4 Press the CLK button to end the clock adjustment mode.

## Tuner features

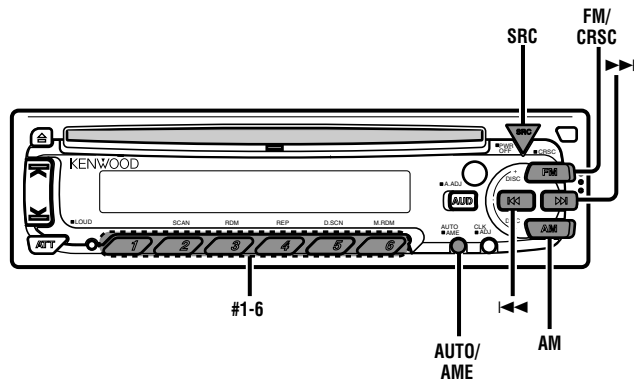

### Tuning

You can choose between auto seek tuning of receivable frequencies and manual tuning.

- 1 Press the SRC (source) button repeatedly to select the tuner mode. "TUnE" is displayed when the tuner mode has been selected.
- 2 Press either the FM or AM button to select the band. Each time you press the FM button, the band switches between FM1, FM2, and FM3 (which are used for groups of preset stations). Press the AM button to select the AM band.
- 3 Press the AUTO button to switch between auto seek tuning and manual tuning. The AUTO indicator lights up only when auto seek tuning is selected.
- 4 • Auto Seek Tuning  
Press the ►► button to seek higher frequencies.  
Press the ◀◀ button to seek lower frequencies.  
• Manual Tuning  
Press the ►► button to increase the frequency by one step.  
Press the ◀◀ button to decrease the frequency by one step.

#### NOTE

The ST indicator lights up when stereo broadcasts are being received.

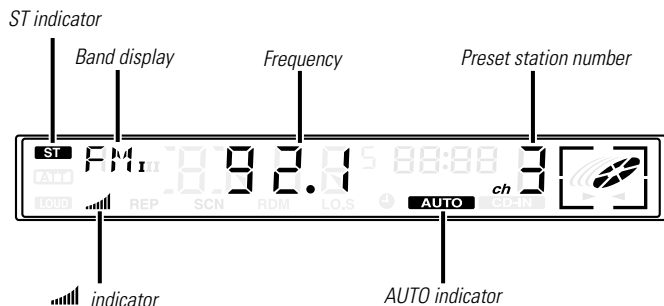

## Tuner features

### Station Preset Memory

Store the frequency of a station. You can then recall that station with a single touch of a button.

- 1 Select the band/ station that you want to have stored.
- 2 Press the button (#1-6) that you want to use for the station, for at least two seconds.  
The button number blinks once in the display to indicate that the data has been stored.

#### Recalling a Preset Station:

Press the preset station button (#1-6) for the desired station. The number of the recalled station is displayed.

#### NOTE

You can store six stations in each of the FM1, FM2, FM3, and AM bands.

### Auto Memory Entry

You can automatically store all the receivable frequencies in the band currently being listened to, and then recall them with the touch of a button later. This function is especially useful when you are travelling and do not know what stations are available. Up to six frequencies can be stored this way.

- 1 Select the band for auto memory entry.
- 2 Press the AME button for at least two seconds to start auto memory entry.  
The numbers of the preset station buttons are shown in order. When all the stations in a certain band are stored in the preset memory, the auto memory entry stops. The tuner then plays the last station received.

#### Recalling a Preset Station:

Press the preset station button (#1-6) for the desired station. The number of the recalled station is displayed.

### Clean Reception System Circuit (CRSC)

Temporarily have reception switched from stereo to mono to reduce multi-path noise when listening to the FM station. The factory default for this function is ON.

#### Turning CRSC On/Off:

Press the CRSC button for at least one second to turn the function on/off.

The  indicator lights up when CRSC is on.

#### NOTE

Strong electrical fields (such as from power lines) may cause unstable sound quality when CRSC is turned on. In such a situation, turn it off.

## CD/External disc control features

### Playing CDs

#### Playing CDs:

If no CDs are inserted, insert one in the slot with the label facing up.

If a CD is already inserted, press the SRC button repeatedly to select the CD mode.

"CD" is displayed when the CD mode has been selected. The CD will start playing.

The CD-IN indicator lights up when a CD has been inserted. The ► indicator lights up when a CD is being played.

#### Stopping and Ejecting CDs:

Press the ▲ button.

The CD stops playing and ejects from the slot.

#### ▲CAUTION

- Do not attempt to insert a CD into the slot if another one is already there.
- The unit can only play 5 in. CDs. If you insert a 3 in. CD, it will get stuck inside and can cause the unit to malfunction.

#### NOTE

When you load a CD and eject it right away, the next time you try to insert the CD may not load. In such a situation, take the CD out for a moment and then reinsert it.

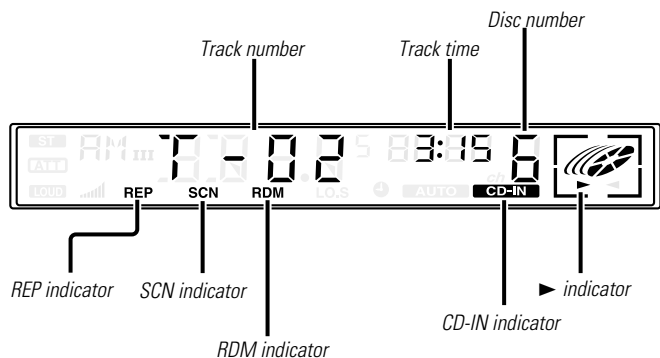
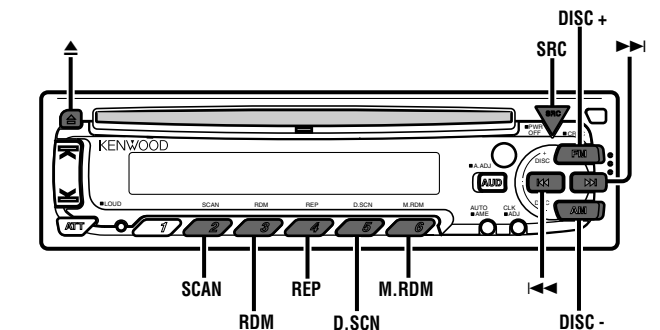

When the disc changer with the O-N selection switch is connected, set the switch to "N" position to operate the external disc control mode.

## CD/External disc control features

Function of the KDC-4015/KDC-415S/KDC-315V/KDC-315S/KDC-35MR

### Playing Other Disc mode

This function permits the connection of optional players and the playing of discs other than the loaded CD (in the current unit).

#### Playing Discs:

Press the SRC button repeatedly to select the external disc control mode.

The disc will start playing.

#### NOTE

The external disc control mode will differ, depending on the unit that is connected.

Mode Display Examples

- "CD2"...when a CD player is connected
- "DISC"...when a disc changer is connected
- "DISC-1", "DISC-2"...when two disc changers are connected

#### NOTE

- When one disc has finished playing its last track, the next disc in the changer will start playing. When the last disc in the changer has finished, the player will return to the first disc and start playing it.
- Disc #10 is displayed as "0".

### Fast Forwarding and Reversing Disc Play

#### Fast Forwarding Disc Play:

Hold down on the ►► button.

Release your finger to play the disc at that point.

#### Reversing Disc Play:

Hold down on the ◀◀ button.

Release your finger to play the disc at the point.

#### NOTE

You cannot use reverse play between tracks depending on the model being connected. Instead, the reverse play function is canceled when it reaches the beginning of a track, at which point normal play will automatically resume.

### Track Search

Search forward or backward through the tracks on the disc until you reach the one that you want to listen to.

#### Making a Reverse Track Search:

Press the ◀◀ button to display the desired track number.

Press once to search back to the beginning of the current track, twice to search back to the beginning of the previous track, and so forth.

Play starts at the beginning of the displayed track number.

#### NOTE

(For disc changers : KDC-4015/KDC-415S/KDC-315V/  
KDC-315S/KDC-35MR only)

Pressing the ◀◀ button while listening to track 1 will only search back to the beginning of that track. The reverse search is not "recycled" to the last track on the disc.

#### Making a Forward Track Search:

Press the ►► button to display the desired track number.

Press once to fast forward to the next track, twice to fast forward to the track after that, and so forth.

Play starts at the beginning of the displayed track number.

#### NOTE

(For disc changers: KDC-4015/KDC-415S/KDC-315V/  
KDC-315S/KDC-35MR only)

You cannot make a forward track search when listening to the last track on a disc.

Function of the KDC-4015/KDC-415S/KDC-315V/KDC-315S/KDC-35MR

### Disc Search

(Function of disc changers)

Search forward or backward through the discs in a disc changer.

#### Making a Reverse Disc Search:

Press the DISC— button to display the desired disc number.

Each time the button is pressed, the displayed disc number decreases by one.

Play starts at the beginning of the displayed disc.

### **Making a Forward Disc Search:**

Press the DISC+ button to display the desired disc number. Each time the button is pressed, the displayed disc number increases by one. Play starts at the beginning of the displayed disc.

#### **NOTE**

"LOAD" is displayed when discs are being exchanged on the disc changer.

### **Starting the Track Scan :**

Press the SCAN button. The SCN indicator lights up and the first 10 seconds of each track will be played, in order. The track number currently being heard blinks in the display.

### **Stopping to Listen to the Track Being Scanned:**

Press the SCAN button again to stop the scan and keep on listening to a track normally.

#### **NOTE**

- The track scan function is canceled when you eject the disc.
- The track scan function only scans each track on a disc once.

## **Track / Disc Repeat**

Repeat playing the track or the disc currently being listened to.

### **Turning Repeat Play On/Off:**

Press the REP button to switch repeat track/disc play on and off as follows:

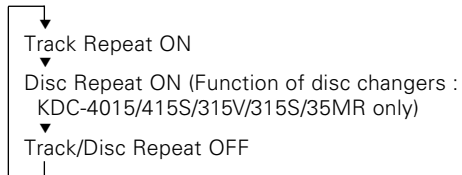

The REP indicator lights up when repeat play is turned on. The track number blinks in the display when track repeat is on. The disc number blinks in the display when disc repeat is on.

#### **NOTE**

Repeat play is canceled when you eject the disc.

## *Function of the KDC-4015/KDC-415S/KDC-315V/KDC-315S/KDC-35MR*

### **Disc Scan**

*(Function of disc changers)*

Successively play the beginning of each disc on a changer until you find the one that you want to listen to.

### **Starting the disc scan:**

Press the D.SCN button. The SCN indicator lights up and the first 10 seconds of each disc will be played, in the order they are loaded on the changer. The disc number currently being heard blinks in the display.

### **Stopping to Listen to the Disc Being Scanned:**

Press the D.SCN button again to stop the scan and keep on listening to the disc normally.

#### **NOTE**

- The disc scan function is canceled when you eject the disc.
- The disc scan function only scans each disc on the changer once.
- "LOAD" is displayed when discs are being exchanged on the disc changer.

## **Track Scan**

Successively play the beginning of each track on a disc until you find the track that you want to listen to.

## CD/External disc control features

### Random Play

Play all the tracks on the current disc in random order.

- 1 Press the RDM button to switch random play on and off. The RDM indicator lights up when random play is turned on. The track number will change over and over in the display as the next track is being selected. When the track has been selected, play will begin. The selected track number blinks in the display as it is being played.

**NOTE** (For disc changers : KDC-4015/KDC-415S/KDC-315V/  
KDC-315S/KDC-35MR only)

When all the tracks on a certain disc have been played using random play, the next disc on the changer will start playing using the same function.

- 2 To change the track being heard, press the ►► button. Another track will be selected and played.

**NOTE**

Random play is canceled when you eject the disc.

**NOTE**

This function is not available with the following models:  
KDC-C200/C300/C400/C301/C401

- 2 To change the track being heard, press the ►► button. Another disc/track will be selected and played.

**NOTE**

- Magazine random play is canceled when you eject the disc.
- The time needed for random selection depends on the number of discs loaded in the disc magazine.

*Function of the KDC-4015/KDC-415S/KDC-315V/KDC-315S/KDC-35MR*

### Magazine Random Play *(Function of disc changers)*

Play the tracks on all the discs in the disc changer in random order.

- 1 Press the M.RDM button to switch magazine random play on and off. The RDM indicator lights up when magazine random play is turned on. The disc and track numbers will change over and over in the display as the next track is being selected. When the disc/track has been selected, play will begin. The selected disc/ track number blinks in the display as it is being played.



## Basic Operations of remote

Accessory of the KDC-4015/415S/315V

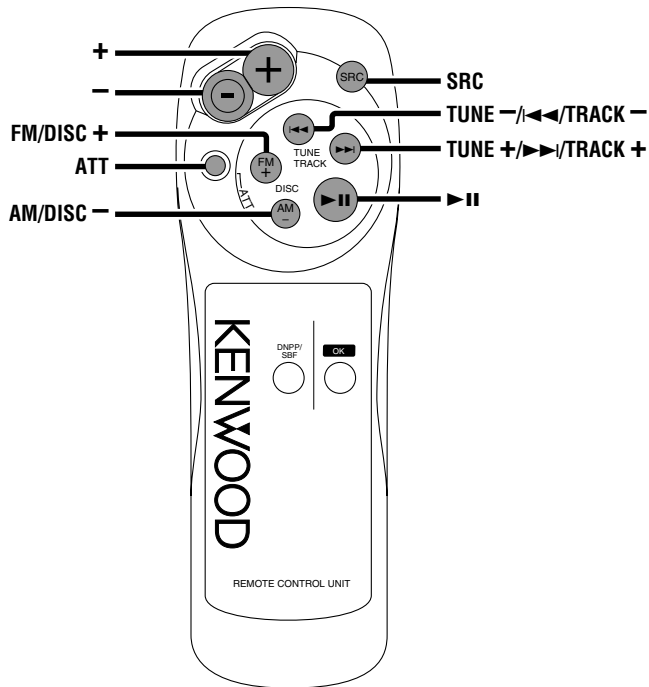

### NOTE

The supplied remote control unit is in its storage case.

### CAUTION

Do not set the remote on hot places such as above the dashboard.

### Loading and Replacing the Batteries:

Use two "AAA"-size batteries.

Slide the cover while pressing downwards to remove it as illustrated.

Insert the batteries with the + and - poles aligned properly, following the illustration inside the case.

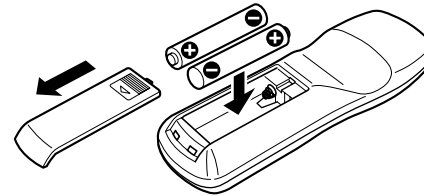

### WARNING

Store unused batteries out of the reach of children. Contact a doctor immediately if the battery is accidentally swallowed.

### NOTE

- The provided batteries are intended for use in operation checking, and their service life may be short.
- When the remote controllable distance becomes short, replace both of the batteries with new ones.
- When A portion of the operations may not be possible, depending on the unit that is connected.

## Basic Operations of remote

Accessory of the KDC-4015/415S/315V

### Basic operations

- **VOLUME buttons**  
Press the + button to turn the volume up.  
Press the - button to turn the volume down.
- **SRC button**  
Each time you press the SRC button, the mode switches as follows:

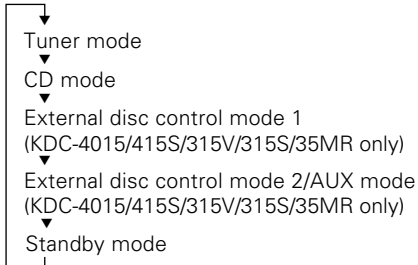

#### NOTE

- The mode switches to the next mode from any mode which cannot be used.
- The external disc control mode will differ depending on the unit that is connected.
- The AUX mode is available only when the changer / AUX switching adapter (KCA-S210A or CA-C1AX) or CD changer (KDC-CPS85, KDC-CX85, KDC-CPS82 or KDC-CX82) is connected to this unit.  
During the AUX mode, "AVin" will show in the display.  
When the CA-C1AX is being used, the AUX Mode will replace the External Disc Control Mode.
- **ATT button**  
Turns down the volume quickly. To return the volume to its original level, press the button again. Turning the volume up, or turning it all the way down deactivates the attenuator function.





### Tuner features

- **◀◀/▶▶ (TUNE) buttons**  
Press the ◀◀ button to decrease the frequency.  
Press the ▶▶ button to increase the frequency.
- **AM/FM button**  
Press the AM button to select the AM band.  
Press the FM button to select and switch between FM1, FM2, and FM3 bands.

### CD/External disc control features

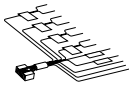
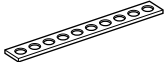
- **◀◀/▶▶ buttons**  
Press the ◀◀ button to search through the tracks backward.  
Press the ▶▶ button to search through the tracks forward.
- **DISC buttons (for disc changers)**  
Press the DISC- button to search through the discs backward.  
Press the DISC+ button to search through the discs forward.
- **▶|| button**  
When a disc is playing, this button pauses the play.  
Press the same button again to start play again.

## Accessories

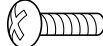
	External view	Number of items
①		.....1
②		.....1
③		.....2
④		.....1
⑤		.....4
⑥		.....4
⑦		.....1

### ▲CAUTION

The use of any accessories except for those provided might result in damage to the unit. Make sure only to use the accessories shipped with the unit, as shown above.

## Installation Procedure

1. To prevent a short circuit, remove the key from the ignition and disconnect the ⊖ battery.
2. Make the proper input and output wire connections for each unit.
3. Connect the speaker wires of the wiring harness.
4. Connect the wiring harness wires in the following order: ground, battery, ignition.
5. Connect the wiring harness connector to the unit.
6. Install the unit in your car.
7. Reconnect the ⊖ battery.
8. Press the reset button.

### ▲CAUTION

- If your car's ignition does not have an ACC position, connect the ignition wires to a power source that can be turned on and off with the ignition key. If you connect the ignition wire to a power source with a constant voltage supply, as with battery wires, the battery may die.
- If the console has a lid, make sure to install the unit so that the faceplate will not hit the lid when closing and opening.
- If the fuse blows, first make sure the wires aren't touching to cause a short circuit, then replace the old fuse with one with the same rating.
- Do not let unconnected wires or terminals touch metal on the car or anything else conducting electricity. To prevent a short circuit, do not remove the caps on the ends of the unconnected wires or the terminals.
- Connect the speaker wires correctly to the terminals to which they correspond. The unit may be damaged or fail to work if you share the ⊖ wires or ground them to any metal part in the car.
- After the unit is installed, check whether the brake lamps, blinkers, wipers, etc. on the car are working properly.
- Insulate unconnected wires with vinyl tape or other similar material.
- Some disc changers need conversion cords for connection. See the section on "Safety Precautions" for details.
- Mount the unit so that the mounting angle is 30° or less.

# Connecting Wires to Terminals

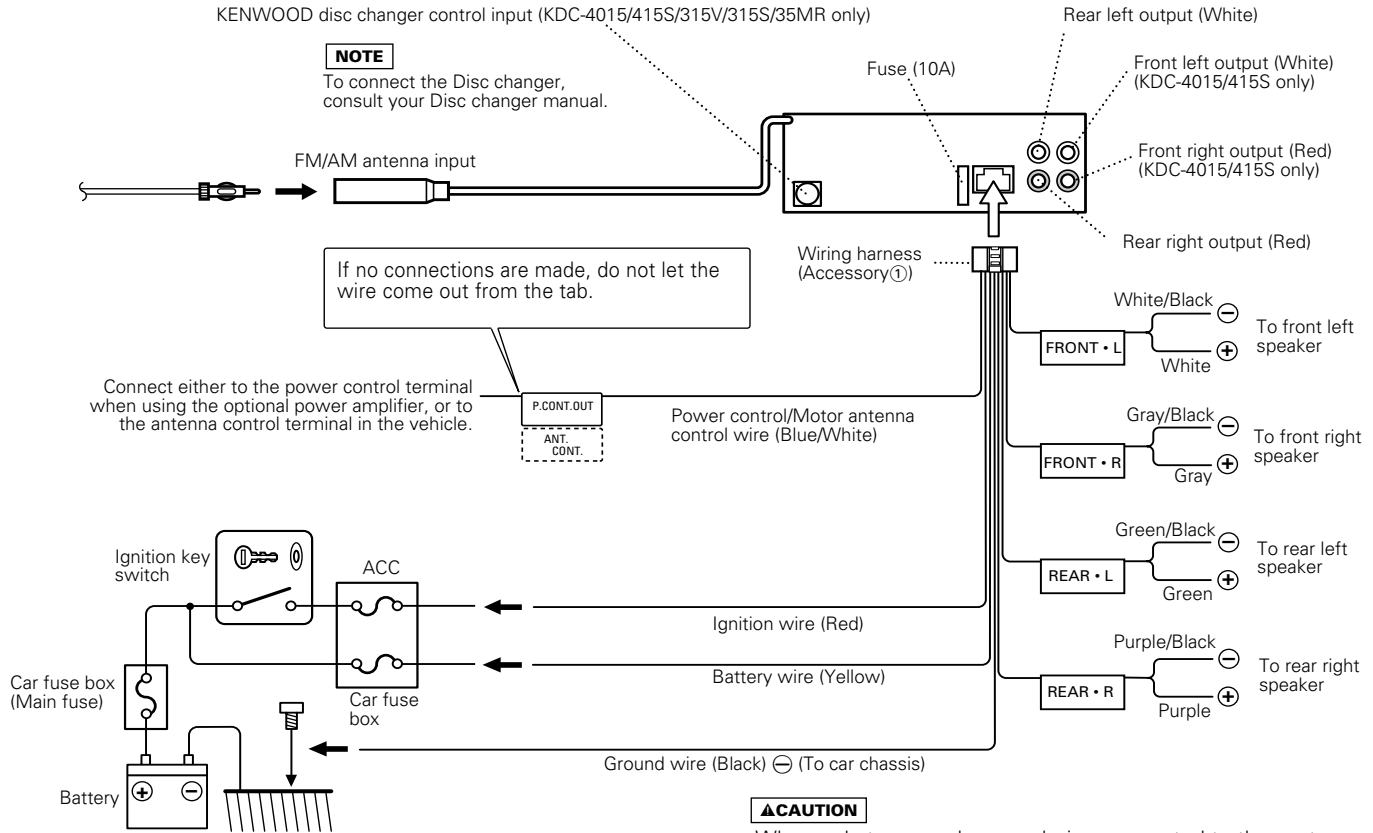

**⚠ WARNING**

If you connect the ignition wire (red) and the battery wire (yellow) to the car chassis (ground), you may cause a short circuit, that in turn may start a fire. Always connect those wires to the power source running through the fuse box.

**⚠ CAUTION**

When only two speakers are being connected to the system, connect the connectors either to both the front output terminals or to both the rear output terminals (do not mix front and rear). For example, if you connect the ⊕ connector of the left speaker to a front output terminal, do not connect the ⊖ connector to a rear output terminal.

## ■ Installation

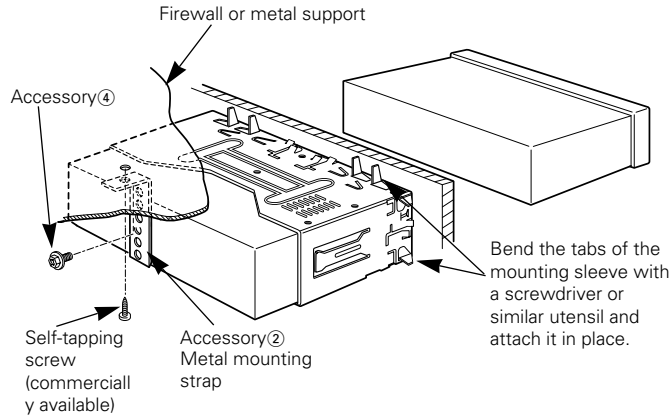

### NOTE

Make sure that the unit is installed securely in place. If the unit is unstable, it may malfunction (for example, the sound may skip).

## ■ Installing in Japanese-Made Cars

- 1 Refer to the section "Removing the hard rubber frame (P. 22)" and then remove the hard rubber frame.
- 2 Align the holes in the unit (two locations on each side) with the vehicle mounting bracket and secure the unit with the accessory screws.

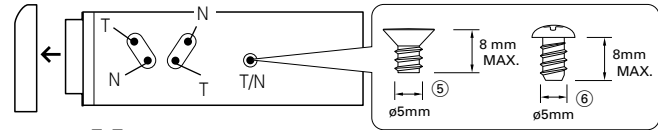

### CAUTION

- During installation, do not use any screws except for those provided. The use of different screws might result in damage to the main unit.
- Damage may occur if a screwdriver or similar tool is used with excessive force during the installations.

## ■ Removing the hard rubber frame

- 1 Engage the catch pins on the removal tool and remove the two locks on the lower level.  
Lower the frame and pull it forward as shown in the figure.

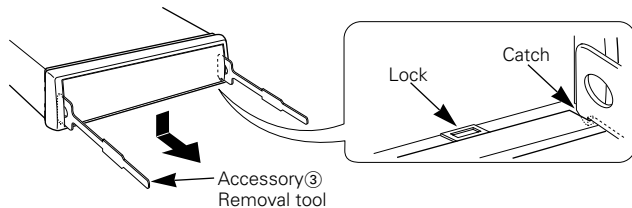

- 2 When the lower level is removed, remove the upper two locations.

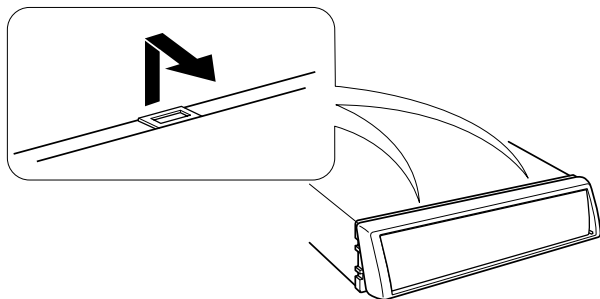

### NOTE

The frame can be removed from the top side in the same manner.

## ■ Removing the Unit

- 1 Refer to the section "Removing the hard rubber frame (P. 22)" and then remove the hard rubber frame.
- 2 Remove the Hex-head screw with integral washer (M4x8) on the back panel.
- 3 Insert the two removal tools deeply into the slots on each side, as shown.

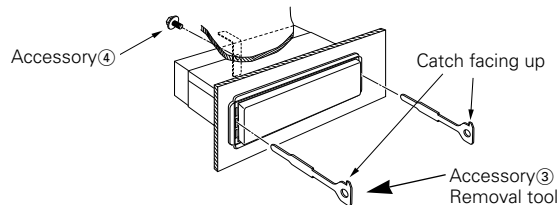

- 4 Lower the removal tool toward the bottom, and pull out the unit halfway whilst pressing towards the inside.

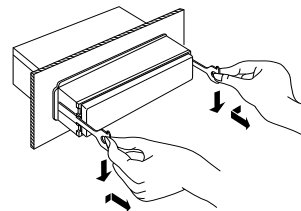

### CAUTION

Be careful to avoid injury from the catch pins on the removal tool.

- 5 Pull the unit all the way out with your hands, being careful not to drop it.

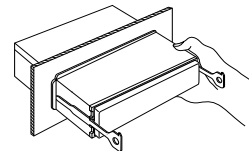

## ■ *Screwing the Faceplate on the Unit*

If you want to fasten the faceplate to the main unit so that it does not fall off, screw in the provided screw ( $\varnothing 4 \times 16$  mm) in the hole shown below.

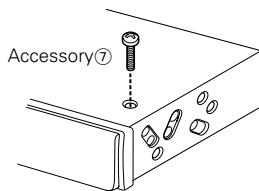

### **▲ CAUTION**

Never insert the taptite screw ( $\varnothing 4 \times 16$  mm) in any other screw hole than the one specified. If you screw it in another hole, it will contact and may cause damage to the mechanical parts inside the unit.

## Troubleshooting Guide

What might seem to be a malfunction in your unit may just be the result of slight misoperation or miswiring. Before calling service, first check the following table for possible problems.

PROBLEM	POSSIBLE CAUSE	SOLUTION
The power does not turn on.	The fuse has blown.	After checking for short circuits in the wires, replace the fuse with one with the same rating.
No sound can be heard, or the volume is low.	Attenuator is turned on.	Turn off Attenuator.
	The fader or balance settings are set all the way to one side.	Reset the fader or balance settings.
	The input/output wires or wiring harness are connected incorrectly.	Reconnect the input/output wires or the wiring harness correctly. See the section on "Connecting Wires to Terminals".
Nothing happens when the buttons are pressed.	The computer chip in the unit is not functioning normally.	Press the reset button on the unit (see p. 5).
The sound quality is poor or distorted.	One of the speaker wires is being pinched by a screw in the car.	Check the speaker wiring.
	The speakers are not wired correctly.	Reconnect the speaker wires so that each output terminal is connected to a different speaker.
Radio reception is poor.	The car antenna is not extended.	Pull the antenna out all the way.
	The antenna control wire is not connected.	Connect the wire correctly, referring to the section on "Connecting Wires to Terminals".
The memory is erased when the ignition is turned off.	The battery wire has not been connected to the proper terminal.	Connect the wire correctly, referring to the section on "Connecting Wires to Terminals".
	The ignition and battery wire are incorrectly connected.	Connect the wire correctly, referring to the section on "Connecting Wires to Terminals".
A CD ejects as soon as it is loaded.	The CD is upside-down.	Load the CD with the labeled side up.
	The CD is quite dirty.	Clean the CD, referring to the section on "Cleaning CDs" (see p. 6).
The sound skips on a CD.	The CD is scratched or dirty.	Clean the CD, referring to the section on "Cleaning CDs" (see p. 6).
A track will not play.	Random play has been selected.	Turn off random play.



## External disc control mode (KDC-4015/KDC-415S/KDC-315S/KDC-35MR only)

PROBLEM	POSSIBLE CAUSE	SOLUTION
The disc control mode cannot be selected.	No wire has been connected to the disc changer input terminal on the unit.	Connect the wire to the disc changer input terminal on the unit.
The specified disc does not play, but another one plays instead.	The specified CD is quite dirty.	Clean the CD.
	The CD is upside-down.	Load the CD with the labeled side up.
	The disc is loaded in a different slot from that specified.	Eject the disc magazine and check the number for the specified disc.
	The disc is severely scratched.	Try another disc instead.
The sound skips.	Something is touching the disc changer.	Remove whatever is touching it.
	The CD is scratched or dirty.	If skipping happens at the same place when the car is stopped, something with the CD is wrong. Clean the CD.
The display shows that the changer is being played, but no sound can be heard.	The computer chip in the unit is not functioning normally.	Press the reset button on the unit (see p. 5).
The specified track will not play.	Random play or magazine random play has been selected.	Turn off random play or magazine random play.

### If the following situations, consult your nearest service center:

- Even though the disc changer is connected, the Disc Changer Mode is not on, with "AVin" showing in the display during the Changer Mode.
- Even though no device (KCA-S210A, CA-C1AX, KDC-CPS85, KDC-CX85, KDC-CPS82 or KDC-CX82) is connected, the AUX Mode is entered when switching modes.

**The following messages are displayed when certain problems are occurring in your system. Take the recommended actions.**

- E-01 No disc magazine has been loaded in the changer. The disc magazine is not completely loaded.  
⇒ Load the disc magazine properly.  
No CD in the unit.  
⇒ Insert the CD.
- E-02 No disc has been loaded in the disc magazine.  
⇒ Load a disc into the disc magazine.
- E-04 No disc has been loaded in the disc magazine.  
⇒ Load a disc into the disc magazine.  
The CD is quite dirty. The CD is upside-down. The CD is scratched a lot.  
⇒ Clean the CD and load it correctly.
- E-10 Nothing has been recorded on the MD.  
⇒ The next MD will automatically be played.
- E-11 No tracks are recorded on the MD, although it has a title.  
⇒ The next MD will automatically be played.
- E-30 The faceplate of the slave unit being connected to this unit has been removed.  
⇒ Replace it.
- E-77 The unit is malfunctioning for some reason.  
⇒ Press the reset button on the unit. If the "E- 77" code does not disappear, consult your nearest service center.
- E-99 Something is wrong with the disc magazine. Or the unit is malfunctioning for some reason.  
⇒ Check the disc magazine. And then press the reset button on the unit. If the "E- 99" code does not disappear, consult your nearest service center.
- E-0d The protective circuit in the unit activates when the temperature inside the automatic disc changer exceeds 60°C (140°F), stopping all operation.  
⇒ Cool down the unit by opening the windows or turning on the air conditioner. As the temperature falls below 60°C (140°F), the disc will start playing again.

## Specifications

### Specifications subject to change without notice.

#### **FM tuner section**

Frequency range (200 kHz space) .....	87.9 MHz – 107.9 MHz
Usable sensitivity (S/N = 30dB).....	9.3dBf (0.8 $\mu$ V/75 $\Omega$ )
Quieting Sensitivity (S/N = 50dB).....	15.2dBf (1.6 $\mu$ V/75 $\Omega$ )
Frequency response ( $\pm$ 3.0 dB) .....	30 Hz – 15 kHz
Signal to Noise ratio (MONO) .....	70 dB
Selectivity ( $\pm$ 400 kHz).....	$\geq$ 80 dB
Stereo separation (1 kHz).....	40 dB

#### **AM tuner section**

Frequency range (10 kHz space) .....	530 kHz – 1700 kHz
Usable sensitivity (S/N = 20dB) .....	28 dB $\mu$ (25 $\mu$ V)

#### **CD player section**

Laser diode .....	GaAlAs ( $\lambda$ =780 nm)
Digital filter (D/A) .....	8 Times Over Sampling
D/A Converter .....	1 Bit
Spindle speed .....	500 – 200 rpm (CLV)
Wow & Flutter .....	Below Measurable Limit
Frequency response ( $\pm$ 1 dB) .....	10 Hz – 20 kHz
Total harmonic distortion (1 kHz) .....	0.01 %
Signal to Noise ratio .....	96 dB (1 kHz)
Dynamic range .....	93 dB
Channel separation .....	85 dB

#### **Audio section**

Maximum output power .....	45 W $\times$ 4
Full bandwidth power (at less than 1% THD).....	22 W $\times$ 4
Tone action	
Bass: .....	100 Hz $\pm$ 10 dB
Treble: .....	10 kHz $\pm$ 10 dB
Preout level / Load.....	1800mV/10k $\Omega$
Preout impedance .....	$\leq$ 600 $\Omega$

#### **General**

Operating voltage .....	14.4 V (11 – 16 V allowable)
Current consumption .....	10 A
Installation size (W $\times$ H $\times$ D) .....	182 $\times$ 53 $\times$ 160 mm
	7-3/16 $\times$ 2-1/16 $\times$ 6-1/4 in.
Weight.....	3.1 Lbs (1.4 kg)

KENWOOD