

# KENWOOD

**KDC-132**  
**KDC-1032**  
**KDC-132CR**

CD-RECEIVER

## INSTRUCTION MANUAL

Kenwood Corporation



**Take the time to read through this instruction manual.**

**Familiarity with installation and operation procedures will help you obtain the best performance from your new CD-receiver.**

**For your records**

Record the serial number, found on the back of the unit, in the spaces designated on the warranty card, and in the space provided below. Refer to the model and serial numbers whenever you call upon your Kenwood dealer for information or service on the product.

Model KDC-132/ KDC-1032/ KDC-132CR Serial number \_\_\_\_\_

***US Residence Only***

### Register Online

Register your Kenwood product at  
**[www.kenwoodusa.com](http://www.kenwoodusa.com)**

# Contents

---

<b>Warning</b>	<b>3</b>	<b>Accessories/ Installation Procedure</b>	<b>15</b>
<b>Safety precautions</b>	<b>4</b>	<b>Connecting Wires to Terminals</b>	<b>16</b>
<b>Notes</b>	<b>5</b>	<b>Installation</b>	<b>17</b>
<b>About CDs</b>	<b>6</b>	<b>Removing the Unit</b>	<b>19</b>
<b>General features</b>	<b>7</b>	<b>Troubleshooting Guide</b>	<b>20</b>
Power		<b>Specifications</b>	<b>22</b>
Selecting the Source			
Volume			
Attenuator			
System Q			
Audio Control			
Audio Setup			
Speaker Setting			
Clock Display			
Adjusting Clock			
Theft Deterrent Faceplate			
<b>Tuner features</b>	<b>11</b>		
Tuning			
Tuning Mode			
Station Preset Memory			
Auto Memory Entry			
Preset Tuning			
CRSC (Clean Reception System Circuit)			
<b>CD player features</b>	<b>13</b>		
Playing CD			
Fast Forwarding and Reversing			
Track Search			
Track Repeat			
Scan Play			
Random Play			

## **▲Warning**

---

### **▲CAUTION**

Use of controls or adjustments or performance of procedures other than those specified herein may result in hazardous radiation exposure. In compliance with Federal Regulations, following are reproductions of labels on, or inside the product relating to laser product safety.

KENWOOD CORPORATION  
2967-3, ISHIKAWA-MACHI,  
HACHIOJI-SHI  
TOKYO, JAPAN

KENWOOD CORP. CERTIFIES THIS EQUIPMENT  
CONFORMS TO DHHS REGULATIONS N0.21 CFR  
1040. 10, CHAPTER 1, SUBCHAPTER J.

Location : Bottom Panel

### **FCC WARNING**

This equipment may generate or use radio frequency energy. Changes or modifications to this equipment may cause harmful interference unless the modifications are expressly approved in the instruction manual. The user could lose the authority to operate this equipment if an unauthorized change or modification is made.

### **NOTE**

This equipment has been tested and found to comply with the limits for a Class B digital device, pursuant to Part 15 of the FCC Rules. These limits are designed to provide reasonable protection against harmful interference in a residential installation. This equipment may cause harmful interference to radio communications, if it is not installed and used in accordance with the instructions. However, there is no guarantee that interference will not occur in a particular installation. If this equipment does cause harmful interference to radio or television reception, which you can determine by turning the equipment off and on, the user is encouraged to try to correct the interference by one or more of the following measures:

- Reorient or relocate the receiving antenna.
- Increase the separation between the equipment and receiver.
- Connect the equipment into an outlet on a circuit different from that to which the receiver is connected.
- Consult the dealer or an experienced radio/TV technician for help.

## Safety precautions

---

### **▲WARNING**

#### **To prevent injury or fire, take the following precautions:**

- To prevent a short circuit, never put or leave any metallic objects (such as coins or metal tools) inside the unit.

### **▲CAUTION**

#### **To prevent damage to the machine, take the following precautions:**

- Make sure to ground the unit to a negative 12V DC power supply.
- Do not install the unit in a spot exposed to direct sunlight or excessive heat or humidity. Also avoid places with too much dust or the possibility of water splashing.
- Do not place the faceplate and the faceplate case in areas exposed to direct sunlight, excessive heat or humidity. Also avoid places with too much dust or the possibility of water splashing.  
(Faceplate case : KDC-1032/ 132CR only)
- To prevent deterioration, do not touch the terminals of the unit or faceplate with your fingers.
- Do not subject the faceplate to excessive shock, as it is a piece of precision equipment.
- When replacing a fuse, only use a new fuse with the prescribed rating. Using a fuse with the wrong rating may cause your unit to malfunction.
- Do not use your own screws. Use only the screws provided. If you use the wrong screws, you could damage the unit.

#### **Do Not Load 3-in. CDs in the CD slot**

If you try to load a 3 in. CD with its adapter into the unit, the adapter might separate from the CD and damage the unit.

### **Lens Fogging**

When you turn on the car heater in cold weather, dew or condensation may form on the lens in the CD player of the unit. Called lens fogging, this condensation on the lens may not allow CDs to play. In such a situation, remove the disc and wait for the condensation to evaporate. If the unit still does not operate normally after a while, consult your Kenwood dealer.

### **NOTE**

This Class B digital apparatus complies with Canadian ICES-003.

## Notes

---

- If you experience problems during installation, consult your Kenwood dealer.
- If the unit fails to operate properly, press the Reset button. The unit returns to factory settings when the Reset button is pressed.

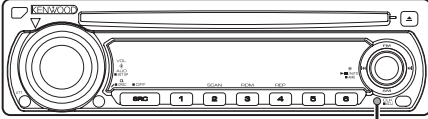

Reset button

- Characters in the LCD may become difficult to read in temperatures below 5 °C (41 °F).
- The illustrations of the display and the panel appearing in this manual are examples used to explain more clearly how the controls are used. Therefore, what appears on the display in the illustrations may differ from what appears on the display on the actual equipment, and some of the illustrations on the display may be inapplicable.

### Cleaning the Unit

If the faceplate of this unit is stained, wipe it with a dry soft cloth such as a silicon cloth.

If the faceplate is stained badly, wipe the stain off with a cloth moistened with neutral cleaner, then wipe it again with a clean soft dry cloth.



- Applying spray cleaner directly to the unit may affect its mechanical parts. Wiping the faceplate with a hard cloth or using a volatile liquid such as thinner or alcohol may scratch the surface or erase characters.

### Cleaning the Faceplate Terminals

If the terminals on the unit or faceplate get dirty, wipe them with a dry, soft cloth.

## About CDs

### Handling CDs

- Do not touch the recording surface of the CD.



- CD-R and CD-RW are easier to damage than a normal music CD. Use a CD-R or a CD-RW after reading the caution items on the package etc.
- Do not stick tape etc. on the CD, or use a CD with tape stuck on it.

### When using a new CD

If the CD center hole or outside rim has burrs, use the CD only after removing the burrs with a ballpoint pen etc.

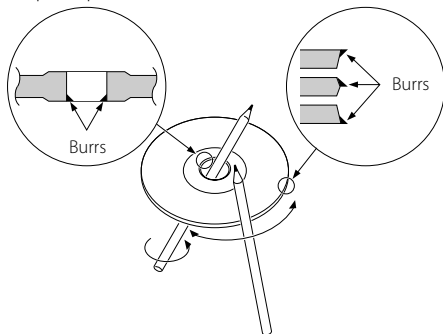

### CD accessories

Do not use disc type accessories.

### CD cleaning

Clean from the center of the disc and move outward.

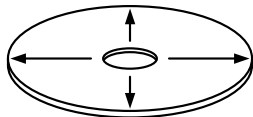

### Removing CDs

When removing CDs from this unit pull them out horizontally.

### CDs that cannot be used

- CDs that are not round cannot be used.

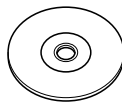

- CDs with coloring on the recording surface or CDs that are dirty cannot be used.
- This unit can only play the CDs with



This unit may not correctly play discs which do not have the mark.

- You cannot play A CD-R or CD-RW that has not been finalized. (For the finalization process refer to your CD-R/CD-RW writing software, and your CD-R/CD-RW recorder instruction manual.)

### CD storage

- Do not place CDs in direct sunlight (On the seat or dashboard etc.) or where the temperature is high.
- Store CDs in their cases.

# General features

---

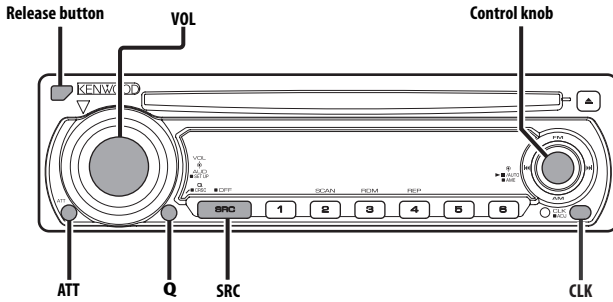

## Power

---

### Turning ON the Power

Press the [SRC] button.

### Turning OFF the Power

Press the [SRC] button for at least 1 second.

## Selecting the Source

---

Press the [SRC] button.

Source required	Display
Tuner	"TUNE"
CD	"CD"
Standby (Illumination only mode)	"STBY"

## Volume

---

### Increasing Volume

Turn the [VOL] knob clockwise.

### Decreasing Volume

Turn the [VOL] knob counterclockwise.

## Attenuator

---

Turning the volume down quickly.

### Press the [ATT] button.

Each time you press the button, the Attenuator turns ON and OFF.

When the Attenuator is ON, the "ATT" indicator blinks.

# General features

## System Q

Selecting the best sound setting preset for different types of music.

### 1 Select the source to set

Press the [SRC] button.

### 2 Select the Sound type

Press the [Q] button.

When you press the button once, the current sound setting is displayed.

Each time you press the button, the sound setting alternates.

Sound setting	Display
Flat	"FLAT"
Rock	"ROCK"
Pops	"POPS"
Easy	"EASY"
Top 40	"TP40"
Jazz	"JAZZ"



- "USER": The values set on the <Audio Control> (page 8). When the System Q setting is changed, the Bass, Middle, and Treble set in audio control replace the System Q values.
- Change each setting value with the <Speaker Setting> (page 9).  
First, select the speaker type with the Speaker setting.

## Audio Control

### 1 Select the source to adjust

Press the [SRC] button.

### 2 Enter Audio Control mode

Press the [VOL] knob.

### 3 Select the Audio item to adjust

Press the [VOL] knob.

Each time you press the knob, the item to be adjusted alternates between the items shown in the table below.

### 4 Adjust the Audio item

Turn the [VOL] knob.

Adjustment Item	Display	Range
Bass level	"BAS"	-8 — +8
Middle level	"MID"	-8 — +8
Treble level	"TRE"	-8 — +8
Balance	"BL"	Left 15 — Right 15
Fader	"FD"	Rear 15 — Front 15

*Exit Audio Control mode (Volume control mode)*

### 5 Exit Audio Control mode

Press any button.

Press a button other than the [VOL] knob, [SRC], [▲] and [ATT] button.

## Audio Setup

Setting the Sound system, such as Volume offset and Loudness.

### 1 Select the source to adjust

Press the [SRC] button.

### 2 Enter Audio Setup mode

Press the [VOL] knob for at least 1 second.

### 3 Select the Audio Setup item to adjust

Press the [VOL] knob.

Each time you press the knob, the item to be adjusted alternates between the items shown in the table below.

### 4 Adjust the Audio setup item

Turn the [VOL] knob.

Adjustment Item	Display	Range
Volume offset	"V-OF"	-8 — ±0
Loudness	"LOUD"	ON/OFF



- Volume offset: Sets each source's volume as a difference from the basic volume.
- Loudness: Compensates for low and high tones during low volume.  
When Loudness is ON, "LOUD" indicator is ON.

### 5 Exit Audio Setup mode

Press the [VOL] knob for at least 1 second.



---

## Speaker Setting

---

Fine-tuning so that the System Q value is optimal when setting the speaker type.

### 1 Enter Standby

Press the [SRC] button.

Select the "STBY" display.

### 2 Enter Speaker Setting mode

Press the [VOL] knob.

### 3 Select the Speaker type

Turn the [VOL] knob.

Each time you turn the knob, the setting alternates between the settings shown in the table below.

Speaker type	Display
OFF	"SP-F"
For 5 & 4 in. speaker	"SP-5"
For 6 & 6x9 in. speaker	"SP-6"
For the OEM speaker	"SP-0"

### 4 Exit Speaker Setting mode

Press the [VOL] knob.

---

## Clock Display

---

Press the [CLK] button.

Each time you press the button, the clock display turns ON and OFF.

---

## Adjusting Clock

---

### 1 Enter Standby

Press the [SRC] button.

Select the "STBY" display.

### 2 Select the clock display

Press the [CLK] button.

### 3 Enter clock adjustment mode

Press the [CLK] button for at least 2 seconds.

The clock display blinks.

### 4 Adjust the hours

Push the Control knob towards [FM] or [AM].

Adjust the minutes

Push the Control knob towards [◀◀] or [▶▶].

### 5 Exit clock adjustment mode

Press the [CLK] button.

## General features

---

### Theft Deterrent Faceplate

The faceplate of the unit can be detached and taken with you, helping to deter theft.

#### Removing the Faceplate

##### Press the Release button.

The faceplate unlocks, allowing you to detach it.



- The faceplate is a precision piece of equipment and can be damaged by shocks or jolts.
- Keep the faceplate in its faceplate case while detached.  
(Faceplate case : Accessory of the KDC-1032/ 132CR)
- Do not expose the faceplate and the faceplate case to direct sunlight or excessive heat or humidity. Also avoid places with too much dust or the possibility of water splashing.

#### Reattaching the Faceplate

##### 1 Align the projections on the unit with the grooves on the faceplate.

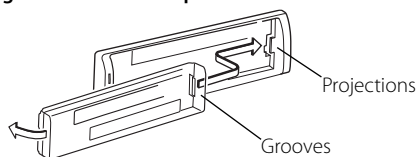

##### 2 Push the faceplate in until it clicks.

The faceplate is locked in place, allowing you to use the unit.

# Tuner features

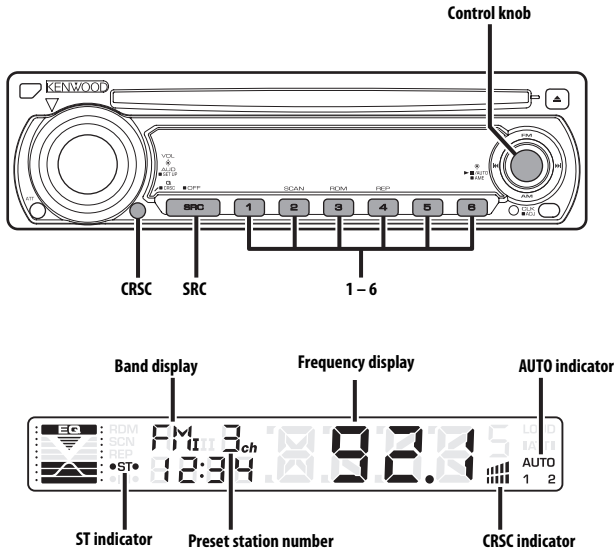

## Tuning

Selecting the station.

### 1 Select tuner source

Press the [SRC] button.

Select the "TUnE" display.

### 2 Select the band

Push the Control knob towards [FM] or [AM].

Each time you push the knob toward [FM], it switches between the FM1, FM2, and FM3 bands.

### 3 Tune up or down band

Push the Control knob towards [◀◀] or

[▶▶].



- During reception of stereo stations the "ST" indicator is ON.

## Tuning Mode

Choose the tuning mode.

### Press the Control knob.

Each time you press the knob, the Tuning mode alternates between the modes shown in the table below.

Tuning mode	Display	Operation
Auto seek	"AUTO 1" indicator	Automatic search for a station.
Preset station seek	"AUTO 2" indicator	Search in order of the stations in the Preset memory.
Manual	—	Normal manual tuning control.

## Tuner features

---

### Station Preset Memory

---

Putting a station in the memory.

- 1 Select the band**  
Push the Control knob towards [FM] or [AM].
- 2 Select the frequency to put in the memory**  
Push the Control knob towards [◀◀] or [▶▶].
- 3 Put the frequency in the memory**  
Press the desired [1] — [6] button for at least 2 seconds.  
The preset number display blinks 1 time.  
On each band, 1 station can be put in the memory on each [1] — [6] button.

### Auto Memory Entry

---

Putting stations with good reception in the memory automatically.

- 1 Select the band for Auto Memory Entry**  
Push the Control knob towards [FM] or [AM].
- 2 Open Auto Memory Entry**  
Press the Control knob for at least 2 seconds.  
When 6 stations that can be received are put in the memory Auto Memory Entry closes.

### Preset Tuning

---

Recalling the stations in the memory.

- 1 Select the band**  
Push the Control knob towards [FM] or [AM].
- 2 Recall the station**  
Press the desired [1] — [6] button.

### CRSC (Clean Reception System Circuit)

---

Temporarily have reception alternate from stereo to mono to reduce multi-path noise when listening to the FM station.

**Press the [CRSC] button for at least 1 second.**

Each time you press the button, CRSC turns ON and OFF.

When CRSC is ON, the CRSC indicator is ON.

## CD player features

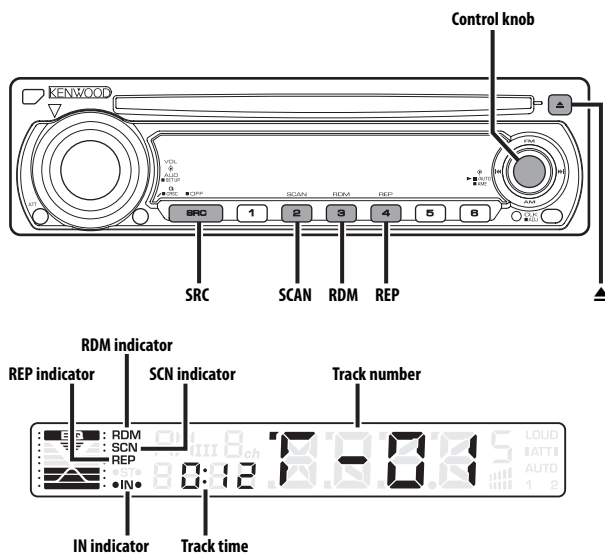

### Playing CD

#### **When a disc is inserted**

Press the [SRC] button.

Select the "CD" display.



- When a CD is inserted, the "IN" indicator is ON.

#### **Pause and play**

Press the Control knob.

Each time you press the knob, the audio pauses or plays.

#### **Eject the CD**

Press the [▲] button.

### Fast Forwarding and Reversing

#### **Fast Forwarding**

Hold down toward [▶▶] with the Control knob.

Release your finger to play the disc at that point.

#### **Reversing**

Hold down toward [◀◀] with the Control knob.

Release your finger to play the disc at that point.

## CD player features

---

### Track Search

---

Selecting the song you want to hear.

Push the Control knob towards [**◀◀**] or [**▶▶**].

### Track Repeat

---

Replaying the song you are listening to.

Press the [**REP**] button.

Each time you press the button, the Track Repeat turns ON or OFF.

When the Track Repeat is ON, the "REP" indicator is ON.

### Scan Play

---

Playing the first part of each song on the disc you are listening to and searching for the song you want to hear.

#### 1 Start Scan Play

Press the [**SCAN**] button.

"SCN" indicator is ON.

#### 2 Release the button when the song you want to hear is played

Press the [**SCAN**] button.

### Random Play

---

Playing all the songs on the disc in random order.

Press the [**RDM**] button.

Each time you press the button, Random Play turns ON or OFF.





When the Random mode is ON, the "RDM" indicator is ON.

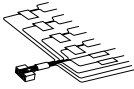

- When you push the Control knob toward [**▶▶**], the next random song starts.

# Accessories/ Installation Procedure

## Accessories

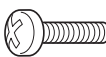
①		.....1
②		.....2
③		.....4
④		.....4
⑤		.....1

## Installation Procedure

1. To prevent a short circuit, remove the key from the ignition and disconnect the ⊖ battery.
2. Make the proper input and output wire connections for each unit.
3. Connect the speaker wires of the wiring harness.
4. Connect the wiring harness wires in the following order: ground, battery, ignition.
5. Connect the wiring harness connector to the unit.
6. Install the unit in your car.
7. Reconnect the ⊖ battery.
8. Press the reset button.

## ▲WARNING

If you connect the ignition wire (red) and the battery wire (yellow) to the car chassis (ground), you may cause a short circuit, that in turn may start a fire. Always connect those wires to the power source running through the fuse box.



- If the power is not turned ON (or it is ON, but will be OFF immediately), the speaker wire may have a short-circuit or touched the chassis of the vehicle and the protection function may have been activated. Therefore, the speaker wire should be checked.
- If your car's ignition does not have an ACC position, connect the ignition wires to a power source that can be turned on and off with the ignition key. If you connect the ignition wire to a power source with a constant voltage supply, as with battery wires, the battery may die.
- If the console has a lid, make sure to install the unit so that the faceplate will not hit the lid when closing and opening.
- If the fuse blows, first make sure the wires aren't touching to cause a short circuit, then replace the old fuse with one with the same rating.
- Insulate unconnected wires with vinyl tape or other similar material. To prevent a short circuit, do not remove the caps on the ends of the unconnected wires or the terminals.
- Connect the speaker wires correctly to the terminals to which they correspond. The unit may be damaged or fail to work if you share the ⊖ wires or ground them to any metal part in the car.
- When only two speakers are being connected to the system, connect the connectors either to both the front output terminals or to both the rear output terminals (do not mix front and rear). For example, if you connect the ⊕ connector of the left speaker to a front output terminal, do not connect the ⊖ connector to a rear output terminal.
- After the unit is installed, check whether the brake lamps, blinkers, wipers, etc. on the car are working properly.
- Mount the unit so that the mounting angle is 30° or less.

# Connecting Wires to Terminals

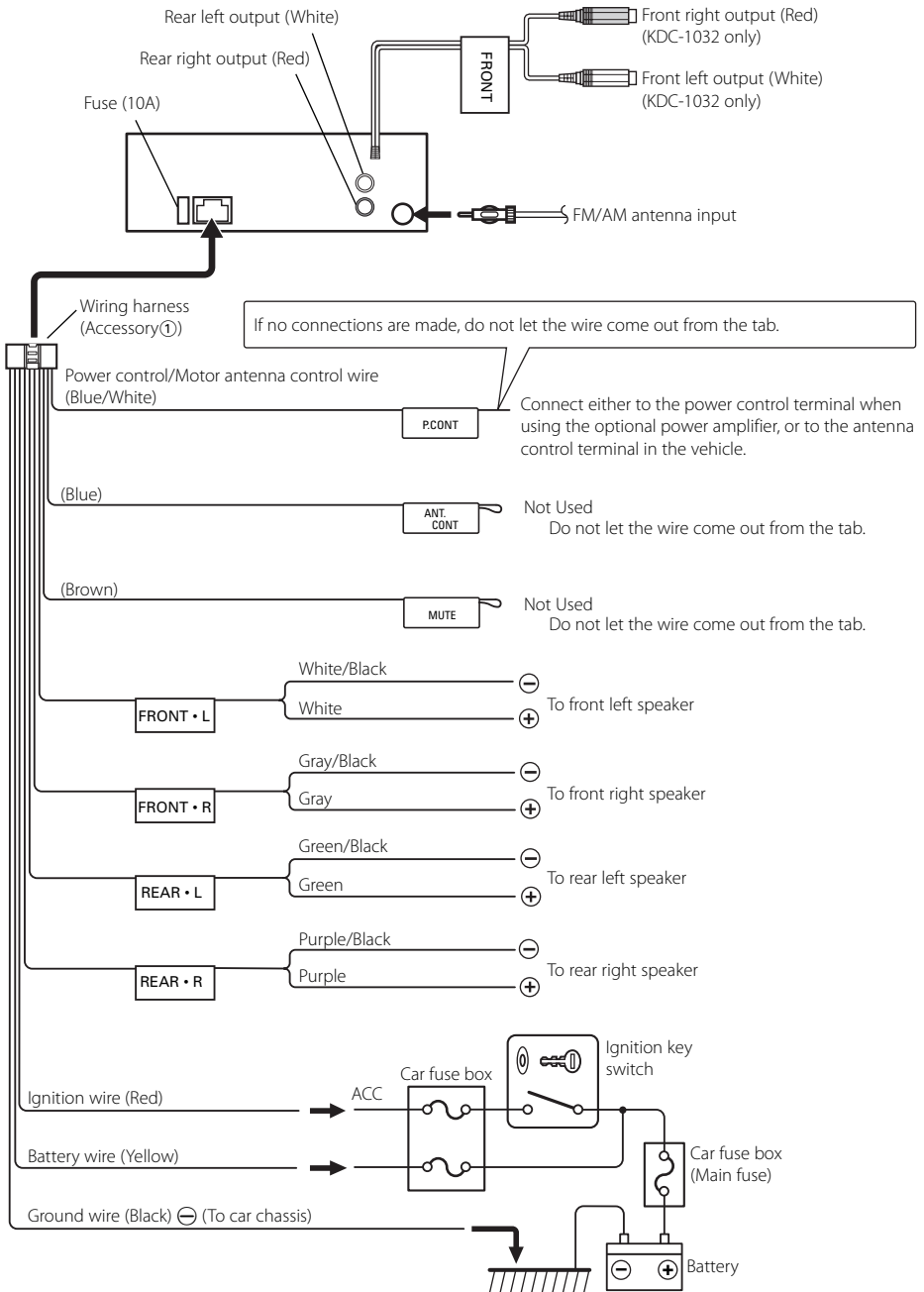



# Installation

## non-Japanese cars

Metal mounting strap  
(commercially available)

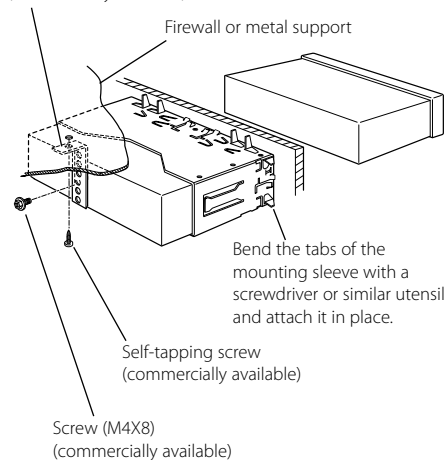

- Make sure that the unit is installed securely in place. If the unit is unstable, it may malfunction (for example, the sound may skip).

## Japanese cars

- 1 Refer to the section <Removing the hard rubber frame> (page 19) and then remove the hard rubber frame.
- 2 Align the holes in the unit (two locations on each side) with the vehicle mounting bracket and secure the unit with the accessory screws.

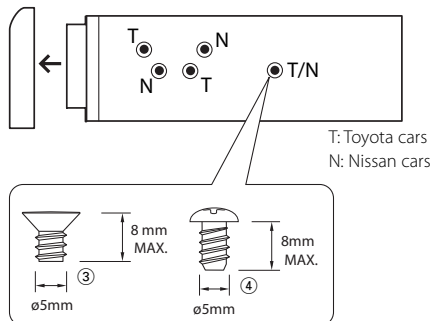

Accessory③...for Nissan car

Accessory④...for Toyota car



- During installation, do not use any screws except for those provided. The use of different screws might result in damage to the main unit.
- Damage may occur if a screwdriver or similar tool is used with excessive force during the installations.

## Installation

---

### **Screwing the Faceplate on the Unit**

If you want to fasten the faceplate to the main unit so that it does not fall off, screw in the provided screws in the holes shown below.

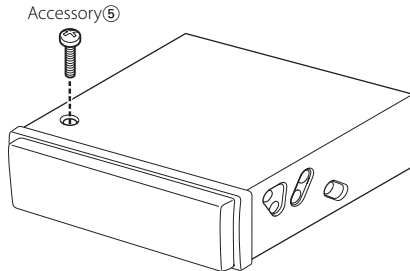

- Never insert the screw in any other screw hole than the one specified. If you screw them in another hole, it will contact and may cause damage to the mechanical parts inside the unit.

# Removing the Unit

## Removing the hard rubber frame

- 1 Engage the catch pins on the removal tool and remove the two locks on the upper level. Upper the frame and pull it forward as shown in the figure.

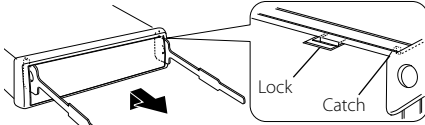

Accessory②  
Removal tool

- 2 When the upper level is removed, remove the lower two locations.

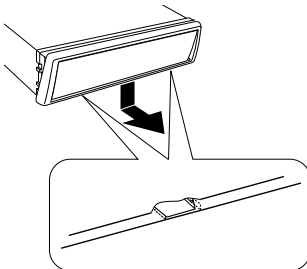

- The frame can be removed from the bottom side in the same manner.

## Removing the Unit

- 1 Refer to the section <Removing the hard rubber frame> (page 19) and then remove the hard rubber frame.
- 2 Remove the screw (M4 × 8) on the back panel.
- 3 Insert the two removal tools deeply into the slots on each side, as shown.

Screw (M4X8)  
(commercially available)

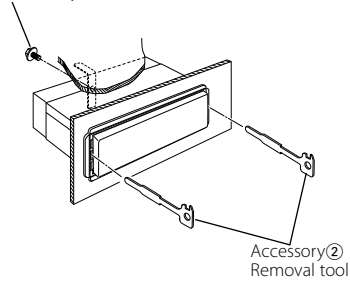

Accessory②  
Removal tool

- 4 Lower the removal tool toward the bottom, and pull out the unit halfway while pressing towards the inside.

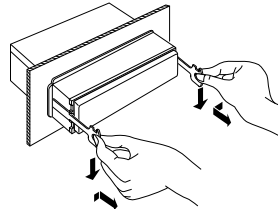

- Be careful to avoid injury from the catch pins on the removal tool.

- 5 Pull the unit all the way out with your hands, being careful not to drop it.

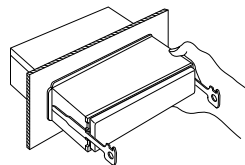

# Troubleshooting Guide

What might seem to be a malfunction in your unit may just be the result of slight misoperation or miswiring. Before calling service, first check the following table for possible problems.

## General

### ? The power does not turn ON.

- ✓ The fuse has blown.
  - ☞ After checking for short circuits in the wires, replace the fuse with one with the same rating.

### ? There's a source you can't switch.

- ✓ There's no media inserted.
  - ☞ Set the media you want to listen to. If there's no media in this unit, you can't switch to each source.

### ? The memory is erased when the ignition is turned OFF.

- ✓ The ignition and battery wire are incorrectly connected.
  - ☞ Connect the wire correctly, referring to the section on <Connecting Wires to Terminals>.

### ? Even if Loudness is turned ON, high-pitched tone isn't compensated for.

- ✓ Tuner source is selected.
  - ☞ High-pitched tone isn't compensated for when in Tuner source.

### ? No sound can be heard, or the volume is low.

- ✓ The fader or balance settings are set all the way to one side.
  - ☞ Center the fader and balance settings.
- ✓ The input/output wires or wiring harness are connected incorrectly.
  - ☞ Reconnect the input/output wires or the wiring harness correctly. See the section on <Connecting Wires to Terminals>.
- ✓ The values of Volume offset are low.
  - ☞ Turn up the Volume offset, referring to the section on <Audio Control> (page 8).

### ? The sound quality is poor or distorted.

- ✓ One of the speaker wires is being pinched by a screw in the car.
  - ☞ Check the speaker wiring.
- ✓ The speakers are not wired correctly.
  - ☞ Reconnect the speaker wires so that each output terminal is connected to a different speaker.

### ? The Touch Sensor Tone doesn't sound.

- ✓ The preout jack is being used.
  - ☞ The Touch Sensor Tone can't be output from the preout jack.

## Tuner source

### ? Radio reception is poor.

- ✓ The car antenna is not extended.
  - ☞ Pull the antenna out all the way.
- ✓ The antenna control wire is not connected.
  - ☞ Connect the wire correctly, referring to the section on <Connecting Wires to Terminals>.

## Disc source

### ? The specified disc does not play, but another one plays instead.

- ✓ The specified CD is quite dirty.  
E38 Clean the CD.

---

- ✓ The disc is loaded in a different slot from that specified.  
E38 Eject the disc magazine and check the number for the specified disc.

---

- ✓ The disc is severely scratched.  
E38 Try another disc instead.

### ? A CD ejects as soon as it is loaded.

- ✓ The CD is quite dirty.  
E38 Clean the CD, referring to the CD cleaning of the section on <About CDs> (page 6).

### ? Can't remove disc.

- ✓ The cause is that more than 10 minutes has elapsed since the vehicle ACC switch was turned OFF.  
E38 The disc can only be removed within 10 minutes of the ACC switch being turned OFF. If more than 10 minutes has elapsed, turn the ACC switch ON again and press the Eject button.

### ? The disc won't insert.

- ✓ There's already another disc inserted.  
E38 Press the [▲] button and remove the disc.

## The messages shown below display your systems condition.

- E-04: The CD is quite dirty. The CD is upside-down. The CD is scratched a lot.  
↔ Clean the CD and load it correctly.
- E-99: The unit is malfunctioning for some reason.  
↔ Press the reset button on the unit. If the "E-99" code does not disappear, consult your nearest service center.
- IN (Blink): The CD player section is not operating properly.  
↔ Reinsert the CD. If the CD cannot be ejected or the display continues to flash even when the CD has been properly reinserted, please switch off the power and consult your nearest service center.

# Specifications

---

Specifications subject to change without notice.

## FM tuner section

---

Frequency range (200 kHz space)  
: 87.9 MHz – 107.9 MHz  
Usable sensitivity (S/N = 30dB)  
: 9.3dBf (0.8  $\mu$ V/75  $\Omega$ )  
Quieting sensitivity (S/N = 50dB)  
: 15.2dBf (1.6  $\mu$ V/75  $\Omega$ )  
Frequency response ( $\pm$ 3.0 dB)  
: 30 Hz – 15 kHz  
Signal to Noise ratio (MONO)  
: 70 dB  
Selectivity ( $\pm$ 400 kHz)  
:  $\geq$  80 dB  
Stereo separation (1 kHz)  
: 40 dB

## AM tuner section

---

Frequency range (10 kHz space)  
: 530 kHz – 1700 kHz  
Usable sensitivity (S/N = 20dB)  
: 28 dB $\mu$  (25  $\mu$ V)

## CD player section

---

Laser diode  
: GaAlAs  
Digital filter (D/A)  
: 8 Times Over Sampling  
D/A Converter  
: 1 Bit  
Spindle speed  
: 500 – 200 rpm (CLV)  
Wow & Flutter  
: Below Measurable Limit  
Frequency response ( $\pm$ 1 dB)  
: 10 Hz – 20 kHz  
Total harmonic distortion (1 kHz)  
: 0.01 %  
Signal to Noise ratio (1 kHz)  
: 93 dB  
Dynamic range  
: 93 dB  
Channel separation  
: 85 dB

## Audio section

---

Maximum output power  
: 45 W x 4  
Full Bandwidth Power (at less than 1% THD)  
: 22 W x 4  
Speaker impedance  
: 4 – 8  $\Omega$   
Tone action  
Bass : 100 Hz  $\pm$ 8 dB  
Middle : 1 kHz  $\pm$ 8 dB  
Treble : 10 kHz  $\pm$ 8 dB  
Preout level / Load (during disc play)  
: 2000 mV/10 k $\Omega$   
Preout impedance  
:  $\leq$  600  $\Omega$

## General

---

Operating voltage (11 – 16V allowable)  
: 14.4 V  
Current consumption  
: 10 A  
Installation Size (W x H x D)  
: 182 x 53 x 155 mm  
7-3/16 x 2-1/16 x 6-1/10 inch  
Weight  
: 2.9 lbs (1.30 kg)