

Packaged unit

Operation Manual

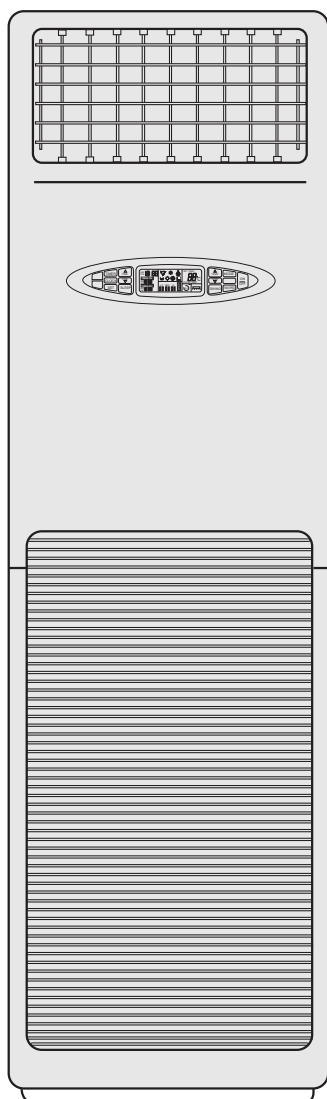

AP42NACAAA
AU42NAIAAA
(HPU-44H03)
AP42NACMAA
AU42NAIMCA
(HPU-42C03)

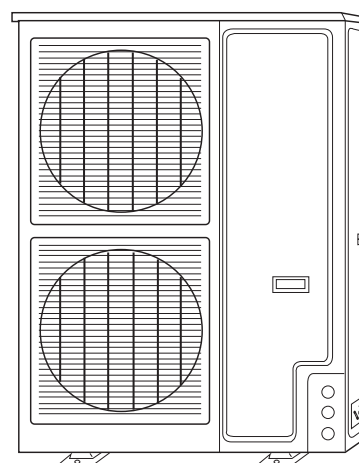
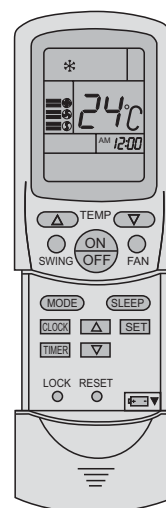

■ Content

Operation

Cautions.....	1-2
Parts	
Indoor unit.....	3
Outdoor unit.....	3
Operation display.....	4
Wireless remote control.....	4
Operation	
Auto	5
Cooling operation.....	6
Dry operation.....	7
Heating operation.....	8
Fan operation.....	9
Sleep	10
Timer ON and Timer OFF.....	11
Air flow adjustment	12
Operation hints	13
Energy saving.....	14
Cautions for the operation.....	15
Maintenance	
Air filter and unit cleaning.....	16
Before/after season maintenance.....	17
Trouble shooting.....	18
When problems occur.....	19
Indoor & outdoor unit connection.....	20
Tools necessary.....	21
Installation procedures.....	22
Electric wiring	27
Others	28

■ CAUTIONS

Disposal of the old air conditioner

Before disposing an old air conditioner that goes out of use, please make sure it's inoperative and safe. Unplug the air conditioner in order to avoid the risk of child entrapment.

It must be noticed that air conditioner system contains refrigerants, which require specialized waste disposal. The valuable materials contained in a air conditioner can be recycled. Contact your local waste disposal center for proper disposal of an old air conditioner and contact your local authority or your dealer if you have any question. Please ensure that the pipework of your air conditioner does not get damaged prior to being picked up by the relevant waste disposal center, and contribute to environmental awareness by insisting on an appropriate, anti-pollution method of disposal.

Disposal of the packaging of your new air conditioner

All the packaging materials employed in the package of your new air conditioner may be disposed without any danger to the environment.

The cardboard box may be broken or cut into smaller pieces and given to a waste paper disposal service. The wrapping bag made of polyethylene and the polyethylene foam pads contain no fluorochloric hydrocarbon.

All these valuable materials may be taken to a waste collecting center and used again after adequate recycling.

Consult your local authorities for the name and address of the waste materials collecting centers and waste paper disposal services nearest to your house.

Safety Instructions and Warnings

Before starting the air conditioner, read the information given in the User's Guide carefully. The User's Guide contains very important observations relating to the assembly, operation and maintenance of the air conditioner.

The manufacturer does not accept responsibility for any damages that may arise due to non-observation of the following instruction.

- Damaged air conditioners are not to be put into operation. In case of doubt, consult your supplier.
- Use of the air conditioner is to be carried out in strict compliance with the relative instructions set forth in the User's Guide.
- Installation shall be done by professional people, don't install unit by yourself.

■ CAUTIONS

- For the purpose of safety, the air conditioner must be properly grounded in accordance with specifications.

- Always remember to unplug the air conditioner before opening inlet grill. Never unplug your air conditioner by pulling on the power cord. Always grip plug firmly and pull straight out from the outlet.

- All electrical repairs must be carried out by qualified electricians. Inadequate repairs may result in a major source of danger for the user of the air conditioner.

-

Do not damage any parts of the air conditioner that carry refrigerant by piercing or perforating the air conditioner's tubes with sharp or pointed items, crushing or twisting any tubes, or scraping the coatings off the surfaces. If the refrigerant spurts out and gets into eyes, it may result in serious eye injuries.

Do not obstruct or cover the ventilation grille of the air conditioner. Do not put fingers or any other things into the inlet/outlet and swing louver.

Do not allow children to play with the air conditioner. In no case should

Specifications

- The refrigerating circuit is leak-proof.

Parts

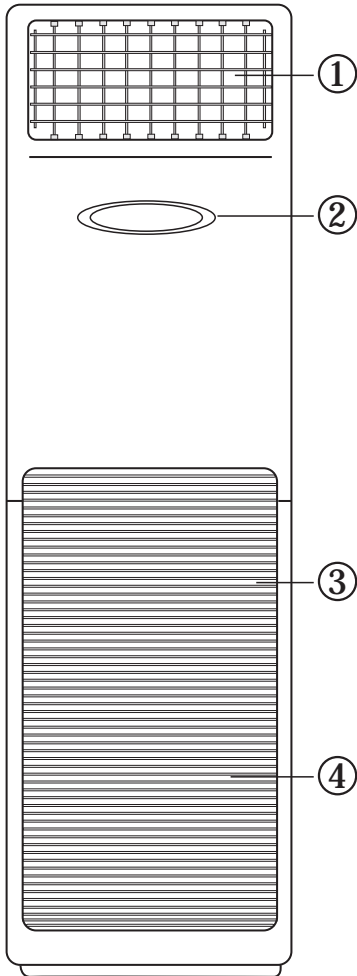

Indoor unit

- ① Outlet grill
- ② Operation panel
- ③ Inlet grill
- ④ Air filter
- ⑤ Remote-controller

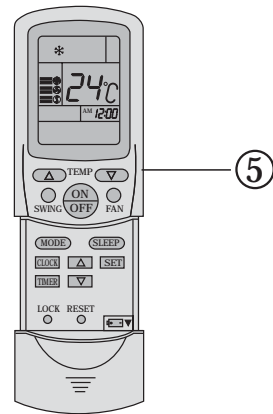

Outdoor unit

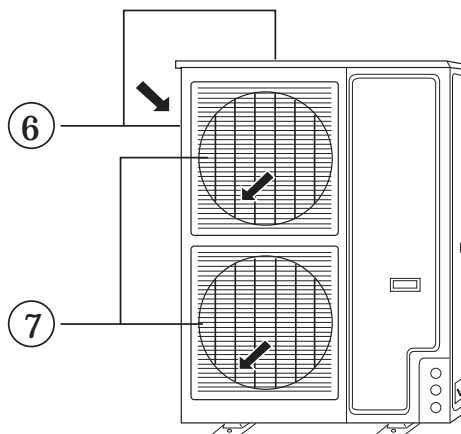

- ⑥ Air inlet
[At side and rear]
- ⑦ Air outlet

Parts

Manual Operation

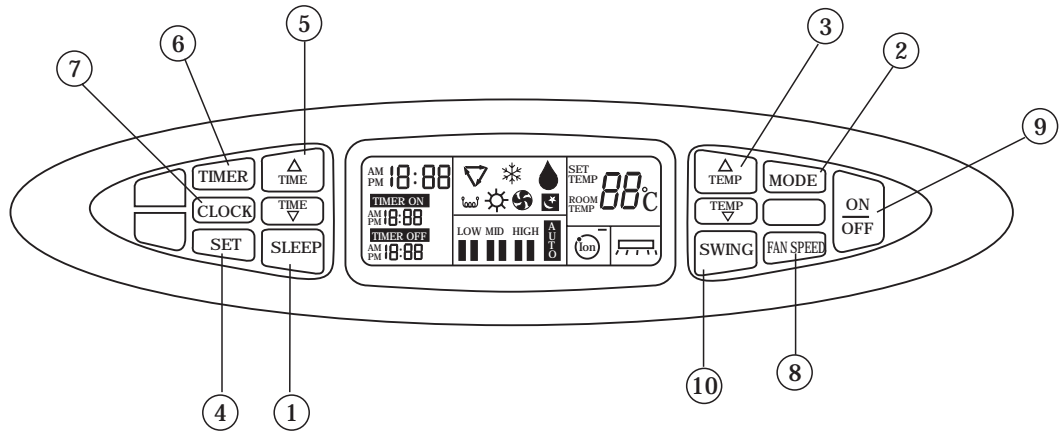

Remote controlled operation

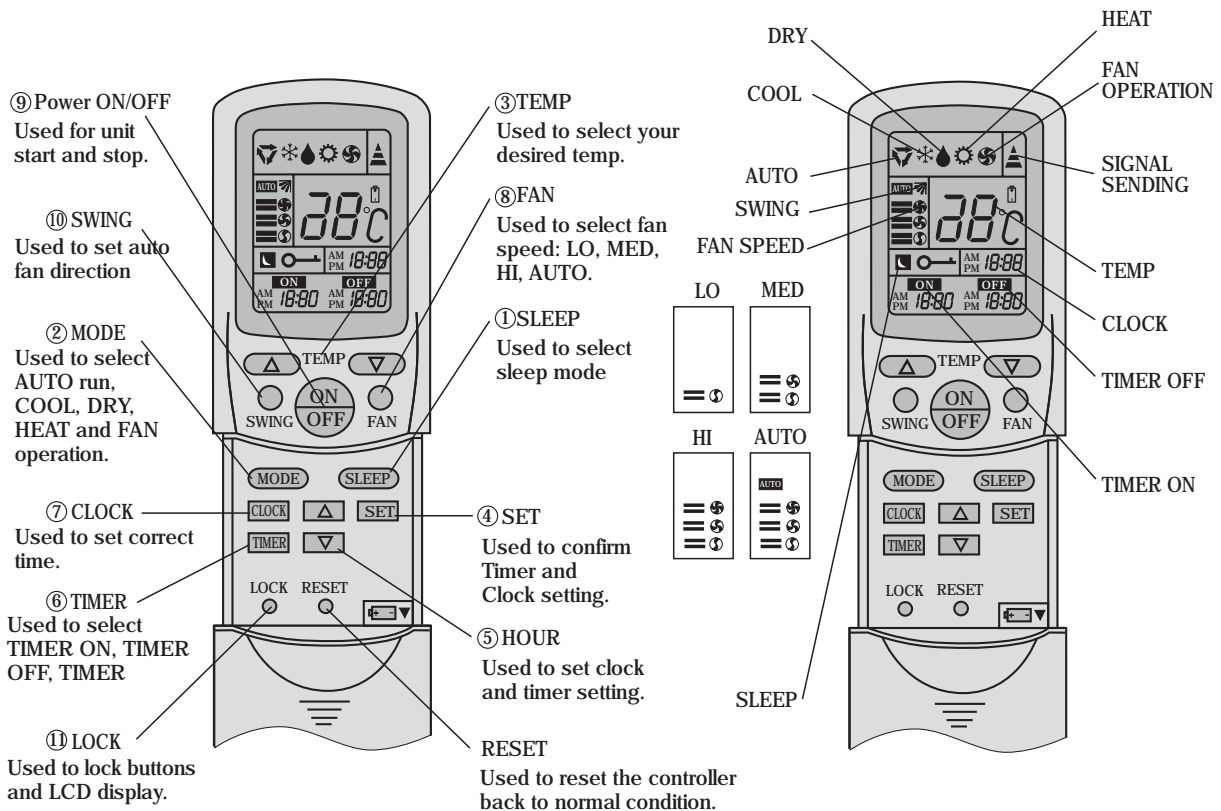

Note: Auxiliary heat function is not available.

For cooling only type, heating function is not available.

■ Operation

Clock set

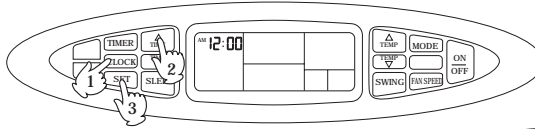

When unit is started for the first time and after replacing batteries in remote controller, clock should be adjusted as follows:
 Press CLOCK button, "AM" or "PM" flashes.
 Press Δ or ∇ to set correct time. Each press will increase or decrease 1min . If the button is kept depressed, time will change quickly.
 After time setting is confirmed, press SET, "AM" and "PM" stop flashing, while clock starts working.

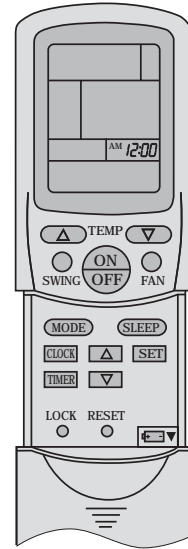

Remote controller's operation

- When in use, put the signal transmission head directly to the receiver hole on the indoor unit
- The distance between the signal transmission head and the receiver hole should be within 7m without any obstacles as well.
- Don't throw the controller, prevent it from being damaged.
- When electronic-started type fluorescent lamp or change-over type fluorescent lamp or wireless telephone is installed in the room, the receiver is apt to be disturbed in receiving the signal so the distance to the indoor unit should be shorter.

Loading of the battery

Slightly press " ∇ " and push down the cover.
 Load the batteries as illustrated.
 2 R-03 dry batteries, (cylinder)
 Be sure that the loading is in line with the "+" / "-" pole request as illustrated.

reset key

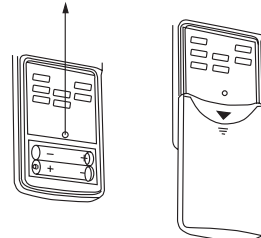

Put on the cover again Confirmation indicator:

In disorderation, reload the batteries or load the new batteries after 5 mins.
 Note: The waster batteries should be disposed properly, use two new same-type batteries when loading.
 If the remote controller can't function normally or doesn't work at all, use a sharp-pointed item to press the reset key.
 Hint: Remove the batteries in case unit won't be in used for a long period.
 If there are any displays after taking-out just need to press reset key.

THE MACHINE IS ADAPTIVE IN FOLLOWING SITUATION

Applicable ambient temperature range:

Cooling	Indoor	Maximum: D.B/W.B	32°C/23°C
		Minimum: D.B/W.B	18°C/14°C
Heating	Outdoor	Maximum: D.B/W.B	43°C/26°C
		Minimum: D.B	18°C
Cooling	Indoor	Maximum: D.B	27°C
		Minimum: D.B	15°C
Heating	Outdoor	Maximum: D.B/W.B	24°C/18°C
		Minimum: D.B/W.B	-7°C/-8°C

■ Operation

Auto

Manual Operation

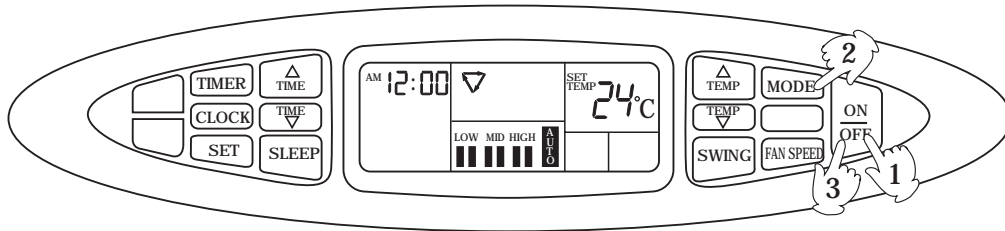

Remote-controlled Operation

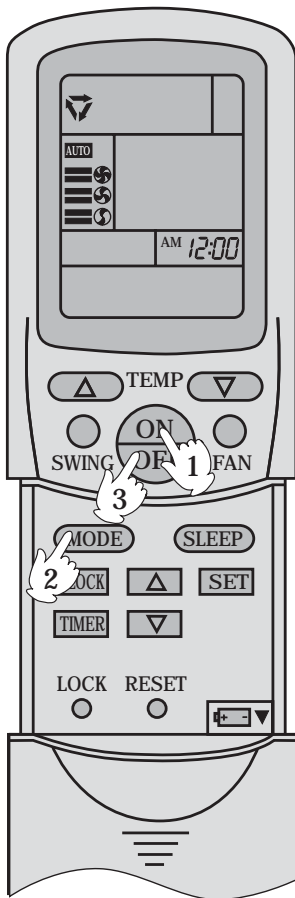

- ① Press ON/OFF button
Unit starts running.
The previous status appears on the display (except. TIMER, SLEEP and SWING mode)

- ② Press MODE button. For each press, operation mode changes as follows:

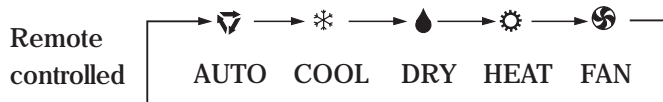
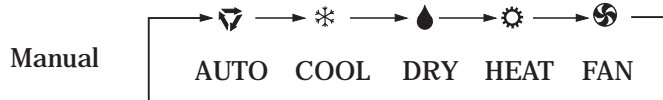

Select Auto run,
" ▽ " appears and auto run starts.

- ③ Press ON/OFF button
Unit stops running.

Note:

During Auto run operation, temp. setting will not be shown in LCD display, unit will select heating, cooling or fan operation according to the room temp.

Manual Operation

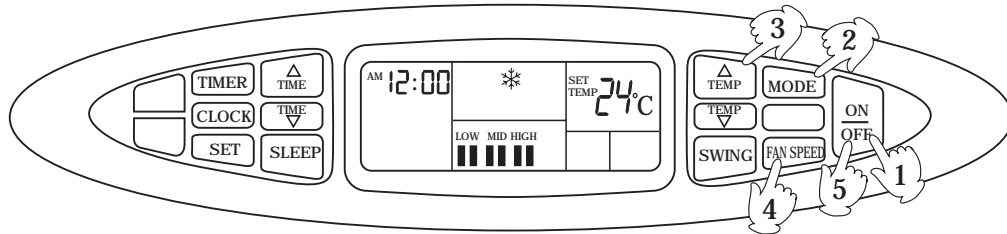

Remote-controlled Operation

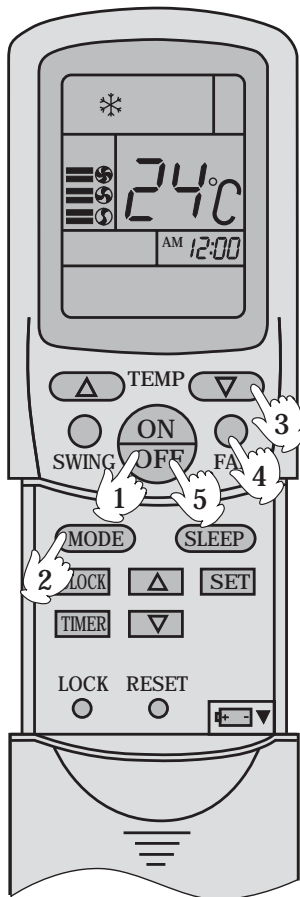

- ① Press ON/OFF button
Unit starts running.
The previous status appears on the display (except. TIMER, SLEEP and SWING mode)

- ② Press MODE button. For each press, operation mode changes as follows:

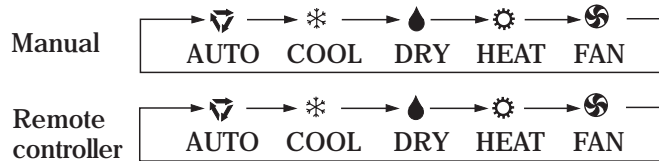

Select cooling operation, Shows "❄️"
Cooling operation starts.

- ③ Select temp. button
Press TEMP button
△ Every time the button is pressed, temp. setting increases 1°C
△ Every time the button is pressed, temp. setting decreases 1°C
If the button is kept pressed, setting will increase or decrease quickly.

- ④ Press FAN button. For each press, fan speed changes as follows:

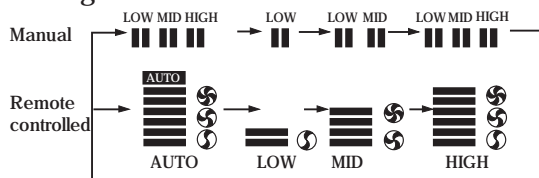

Unit runs at the speed displayed on LCD.

- ⑤ Press ON/OFF button
Unit stops running, and when entering this mode for the next time, it will show the previous setting.

Manual Operation

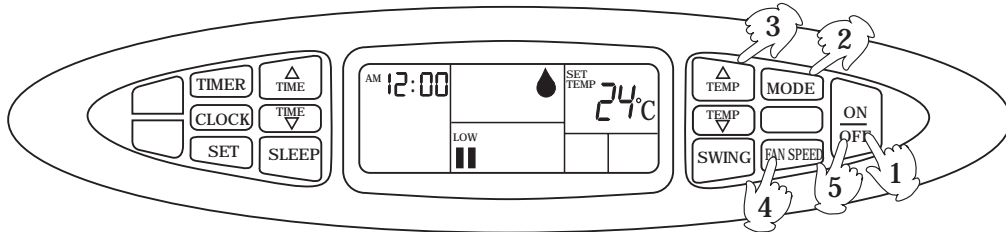

Remote-controlled Operation

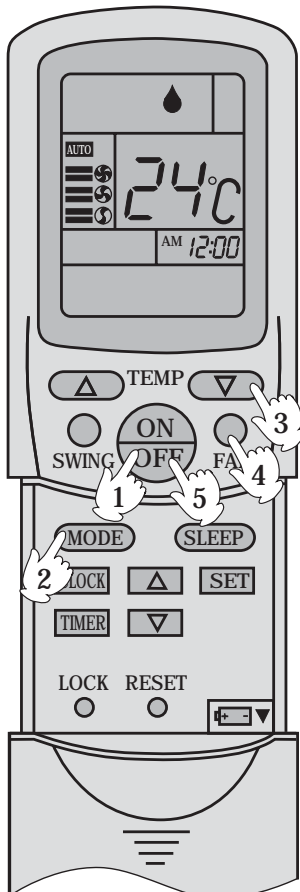

- ① Press ON/OFF button
Unit starts running.
The previous status appears on the display (except. TIMER, SLEEP and SWING mode)

- ② Press MODE button. For each press, operation mode changes as follows:



Select Drying operation shows "💧"
Dry operation starts

- ③ Select temp. button
Press TEMP button
△ Every time the button is pressed, temp. setting increases 1°C
△ Every time the button is pressed, temp. setting decreases 1°C
If the button is kept pressed, setting will increase or decrease quickly.

- ④ Press FAN button. For each press, fan speed changes as follows:

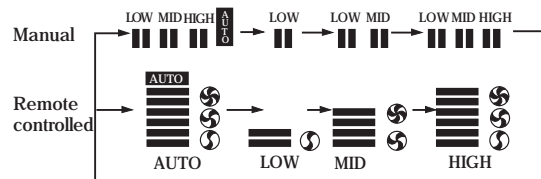

Unit runs at the speed displayed on LCD.

In DRY mode, when room temp. becomes 2°C higher than temp. setting, unit will run intermittently at LOW speed regardless of FAN setting.

- ⑤ Press ON/OFF button
Unit stops running, and when entering this mode for the next time, it will show the previous setting

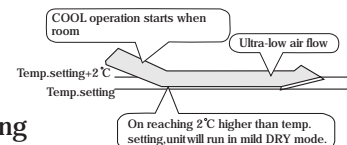

Note: For cooling only type, this function is invalid.

Manual Operation

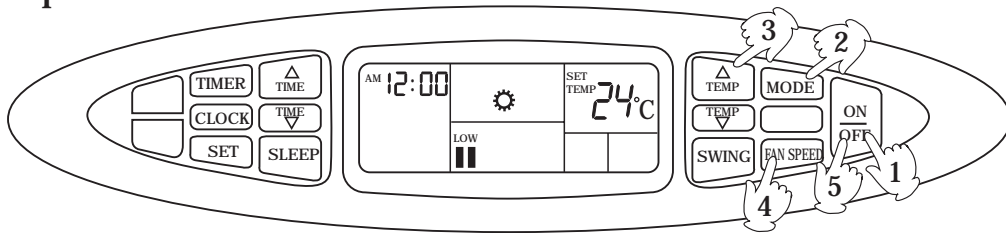

Remote-controlled Operation

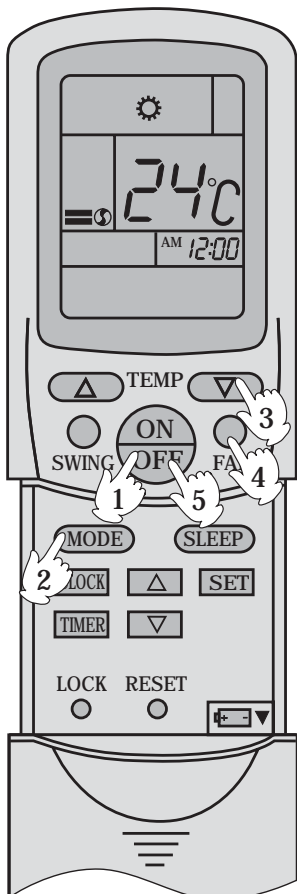

- ① Press ON/OFF button
Unit starts running.
The previous status appears on the display (except. TIMER, SLEEP and SWING mode)

- ② Press MODE button. For each press, operation mode changes as follows:

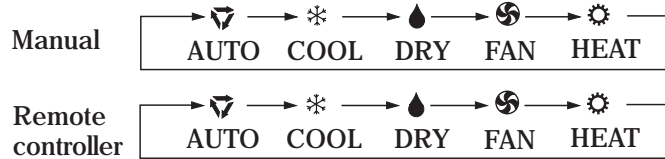

Select Heating operation " ⚙️ " appears and Heating operation starts.

- ③ Select temp. button
Press TEMP button
 △ Every time the button is pressed, temp. setting increases 1°C
 ▽ Every time the button is pressed, temp. setting decreases 1°C
 If the button is kept pressed, setting will increase or decrease quickly.

- ④ Press FAN button. For each press, fan speed changes as follows:

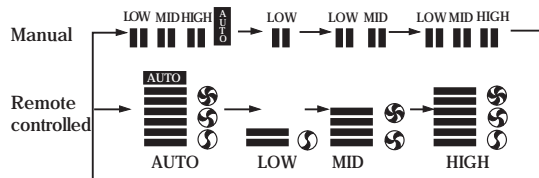

In the mode, warm air will blow out after a short period of time due to cold-draft prevention function.

- ⑤ Press ON/OFF button
Unit stops setting when entering this mode next time.

Manual Operation

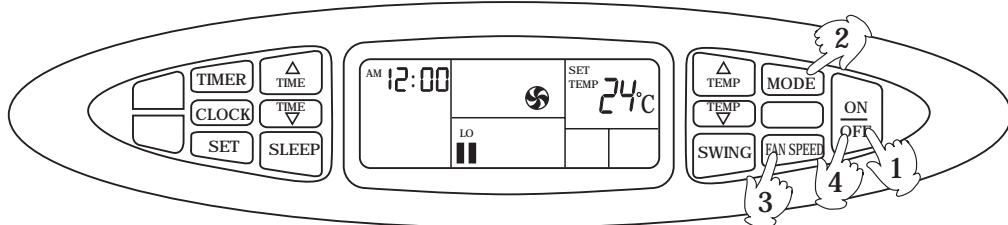

Remote-controlled Operation

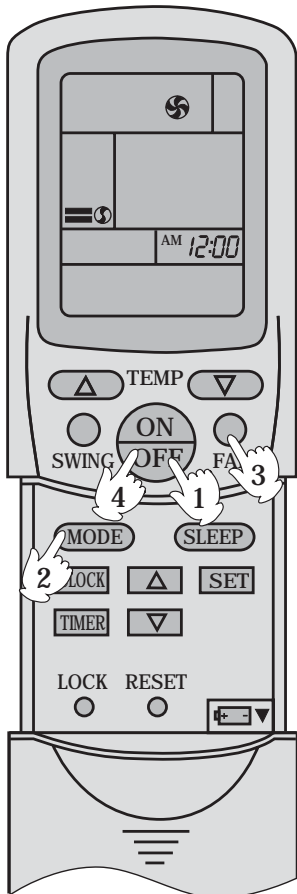

- ① Press ON/OFF button
Unit starts running.
The previous status appears on the display (except. TIMER, SLEEP and SWING mode)

- ② Press MODE button. For each press, operation mode changes as follows:

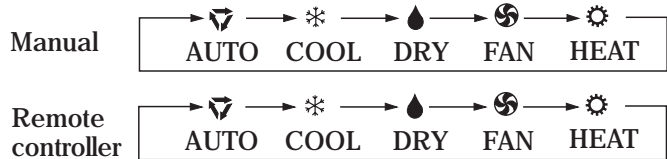

Select Fan operation shows " ", Fan operation starts.

- ③ Press FAN button. For each press, fan speed changes as follows:

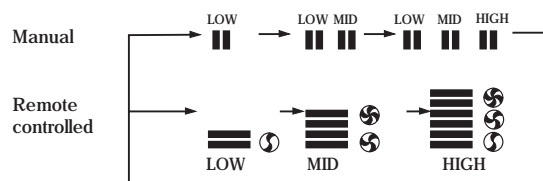

- ④ Press ON/OFF button
Unit stops running, and when entering this mode for the next time, it will show the previous setting.

Note:

In this mode, temp. can't be selected, temp.setting will not be show in LCD display.In Fan operation mode, "AUTO" fan speed is not available. Operation cycles are as follows:



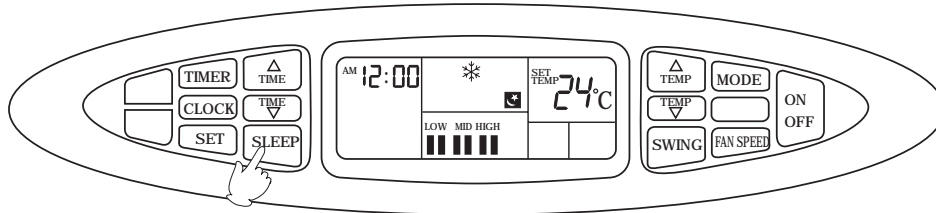

Remote-controlled operation

Before sleeping you can press the Sleep button. The conditioner will run under comfort sleep mode, and give you a comfort sleep.

Usage of the Sleep function

After starting, set the Run mode and press the Sleep button. Run mode

1. In cooling and dry

After starting of the Sleep operation, the temperature will be raised for 1°C higher than the set temperature 1 hour later, and be raised for 1°C after another hour. It continues under that condition for 6 hours, then the machine will be switched off. The temperature is higher than the set temperature so as to avoid catching cold in sleeping.

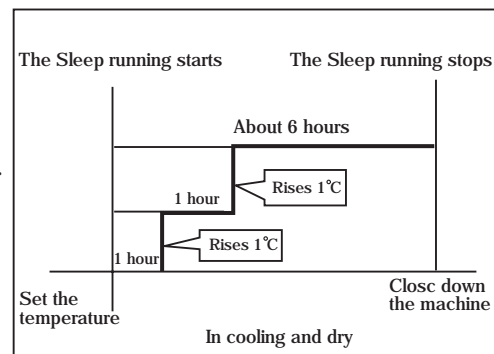

2. In heating (the single-cooling conditioners do not have the function)

After the Sleep running starts, the temperature will drop for 2°C after another one hour. The temperature will raise for 1°C after 3 hours running under the above temperature, and the conditioner will be closed down after running for 3 hours. The temperature is lower than the set temperature so as to avoid uneasiness in sleeping.

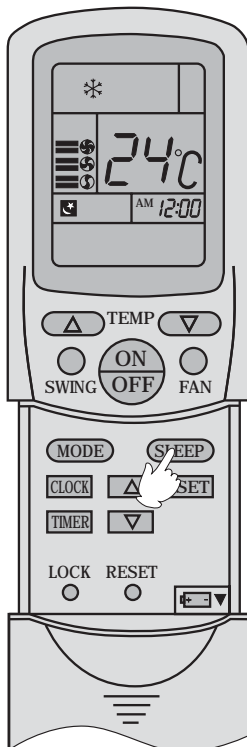
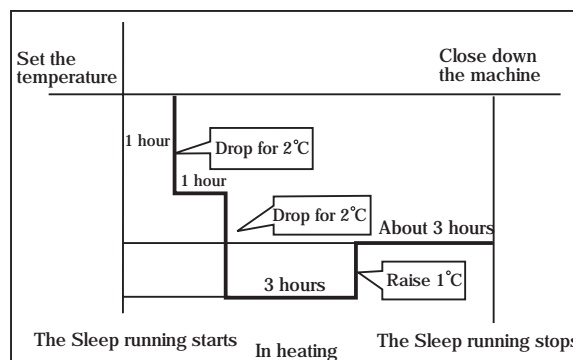

3. In automatic running

The conditioner will run under automatically selected working mode of sleeping.

4. In Fan running

The Sleep function is invalid.

Operation

Timer on/off operation

Manual Operation

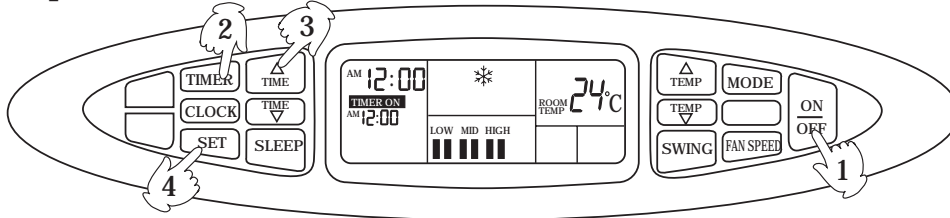

Remote controlled operation

TIMER operation

Set Clock correctly before starting Timer operation (refer to page 5)

You can let unit start or stop automatically at following times: Before you wake up in the morning, or get back from outside or after you fall asleep at night.

TIMER ON/OFF

(1) After unit start, select your desired operation mode.
Operation mode will be displayed on LCD.

(2) TIMER mode selection

Press TIMER button to change TIMER mode.

Every time the button is pressed, display changes as follows:

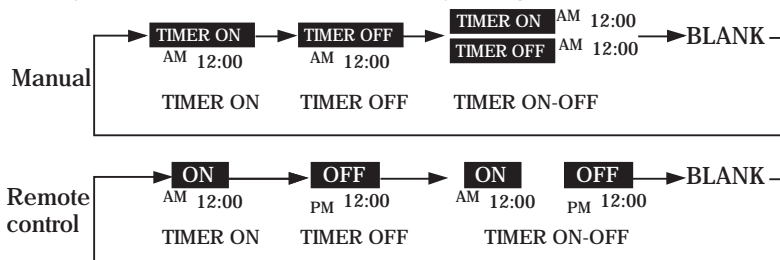

Select your desired TIMER mode (TIMER ON or TIMER OFF) ON or OFF will flash.

(3) Timer setting

Press HOUR Δ / ∇ button.

Δ Every time the button is pressed, time increases 10 min, If button is kept pressed, time will change quickly.

∇ Every time the button is pressed, time decreases 10 min, If button is kept pressed, time will change quickly. Time will be shown on LCD. It can be adjusted within 24 hours.

(4) Confirming your setting

After setting correct time, press SET button to confirm, "ON" or "OFF" stops flashing.

Time displayed: Unit starts or stops at x hour x min (TIMER ON or TIMER OFF)

Timer mode indicator on indoor unit lights up.

To cancel TIMER mode

Just press TIMER button several times until TIMER mode disappears.

Hints

After replacing batteries or a power failure happens, Time setting should be reset.

Remote controller possesses memory function when use TIMER mode next time, just Press SET button after mode selecting if timer setting is the same as previous one.

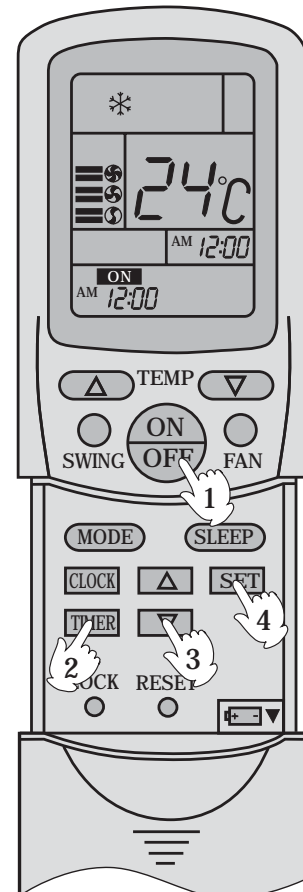

Operation

Timer on-off function

Manual Operation

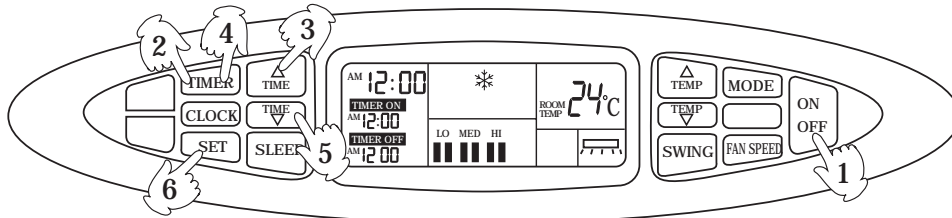

Remote controlled operation

TIMER ON-OFF

(1) After unit start, select your desired operation mode.

Operation mode will be displayed on LCD.

(2) TIMER mode selection

Press TIMER button to change TIMER mode.

Every time the button is pressed, display changes as follows:

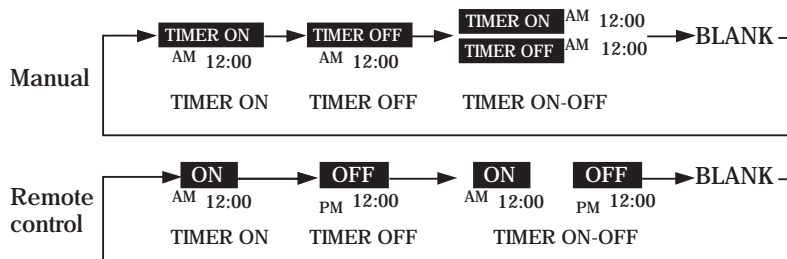

(3) Timer setting for TIMER ON

Press HOUR button.

△ Every time the button is pressed, time increases 10 min. If button is kept pressed, time will change quickly.

▽ Every time the button is pressed, time decreases 10 min. If button is kept pressed, time will change quickly.

Time will be shown on LCD.

It can be adjusted within 24 hours.

AM refers to morning and PM to afternoon.

(4) Time confirming for TIMER ON

After time setting, press TIMER button to confirm,

"ON" stops blinking, while "OFF" starts blinking.

Time displayed: Unit starts or stops at x hour x min

(5) Time setting for TIMER OFF

Follow the same procedure in "Time setting for TIMER ON".

(6) Time confirming for TIMER OFF

After time setting, press SET button to confirm, "OFF" stops flashing.

Time displayed: Unit stops at x hour x min

To cancel TIMER mode

Just press TIMER button several times until TIMER mode disappears.

According to the Time setting sequence of TIMER ON or TIMER OFF, either ON-OFF or OFF-ON can be achieved.

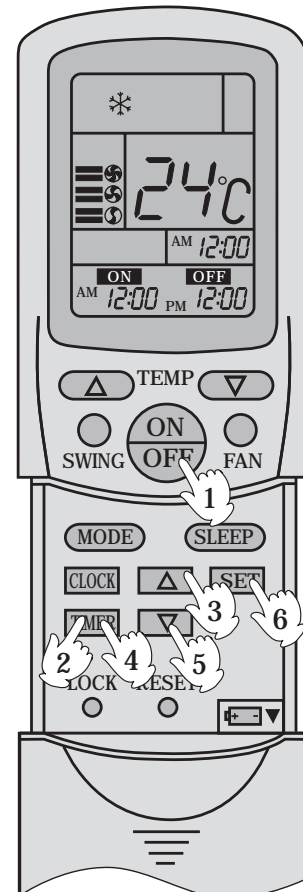

■ Operation

Air flow adjustment

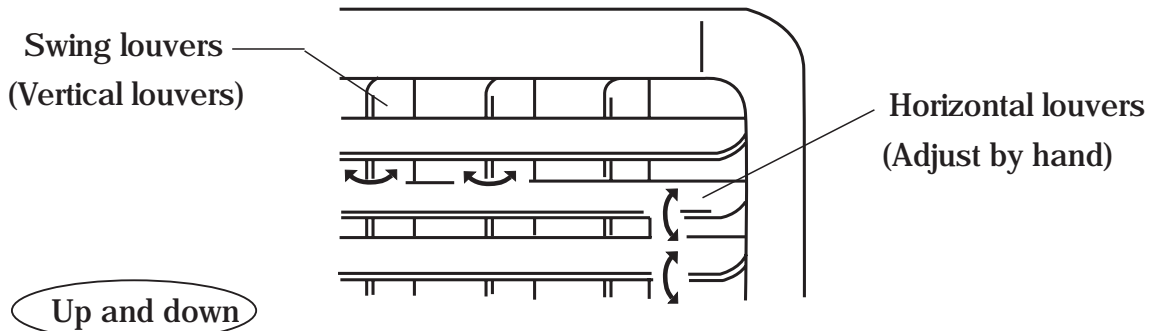

- Adjust the louvers by hand to proper position.

Note: Put louvers at up position in cooling and down position in heating mode. This will be helpful to keep an even room temp.

Notice: In cooling or dry operation, don't put horizontal louvers at downward position for a long time, or outlet grill might get frosted. Don't expose your skin to cool or warm air for a long time.

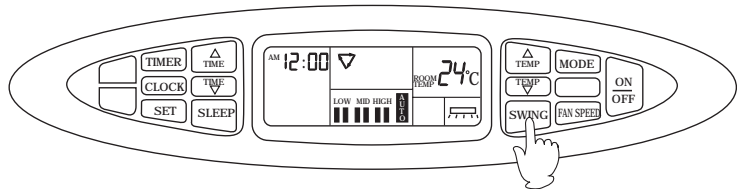
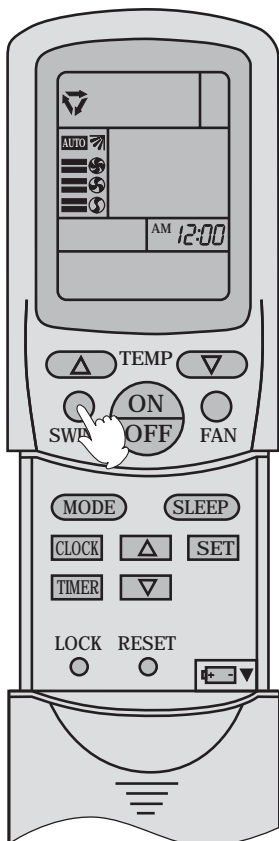

Side from side

Swing

- Press SWING " ⇄ " or " ↕ " appears on the display, the vertical louvers move from side to side.

Fixed position

- Press the SWING again to fix the vertical louvers at your desired position.

■ Operation hints

Unit operation

- Protection devices inside the unit will activate to stop unit operation, when ambient temp. is extremely low or high.
- When unit is running under high humidity in cooling or dehumidifying mode, condensate might appear at outlet grill.

3-min delay protection

- Unit will not restart until 3 min have elapsed for the protection of the unit.

Fan speed changes

- When Fan speed is set at Auto in cooling mode, it will be automatically reduced as room temp. is approaching temp. setting.
- In heating mode. when room temp. reaches temp. setting, compressor will stop and fan speed LOW or stop.
- In dry mode, fan speed will change automatically.

Cold draft prevention

- In heating mode, indoor fan will not run for the first 2-5 min. due to cold draft prevention.

Defrosting

- When frost accumulates on heat exchanger in heating mode, unit will start defrosting automatically.
- During defrosting, both indoor and outdoor fan stop.
- After defrosting, unit resumes running.

Use objectively

- Heat pump works by means of absorbing outside heat to warm room air, so outdoor temp. degree will affect unit's heating efficiency.

■ Energy saving

Keep proper room temp.

Too cold or too warm is no good to your health, and power consumption will be increased as well.

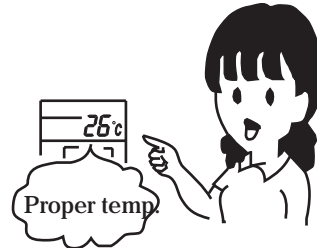

Air filter should be periodically cleaned

If air filter is clogged:
It will cause poor cooling and heating efficiency, higher power consumption and even problem may occur. In cooling operation, water will flow out.

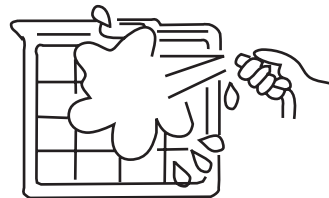

Use Timer effectively

You may use Timer mode to keep a comfortable room temp. when you wake up or come home from outside.

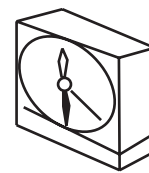
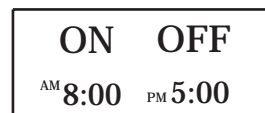

Avoid direct sunlight and air flow

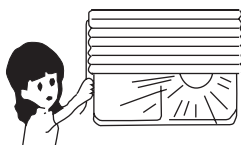

Adjust air flow properly



■ Cautions for the operation

Use control panel to operate the unit.

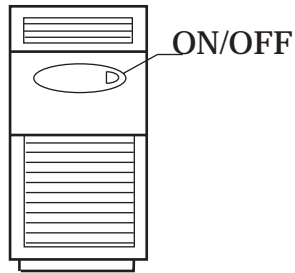

Don't press buttons unless necessary.

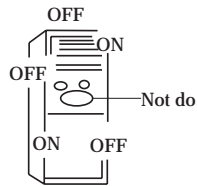

Use fuses of the right capacity. Never use iron or copper wires instead.

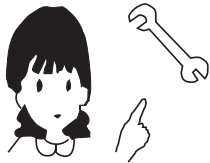

Don't touch moving outlet grills.

Keep a smooth air flow to inlet and outlet of both indoor and outdoor unit.

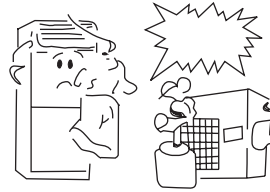

To avoid accident, don't insert any object into air grill.

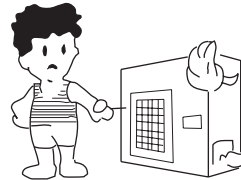

Don't spray any paint or insecticide on the unit.

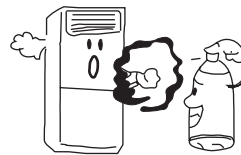



This will cause damage or even fire accident.

Don't splash water directly on indoor unit.

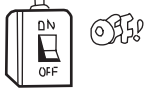

■ Maintenance

Disconnect power supply	Don't touch it with wet hand	Don't wash with hot water or solvent to clean the unit
		

Air filter cleaning

- Pull it out from top as shown in Fig.
- Use water or vacuum cleaner to clean it. If it is extremely dirty, wash it with neutral detergent or soap water.
- Wash it with clean water and install it after complete dry.

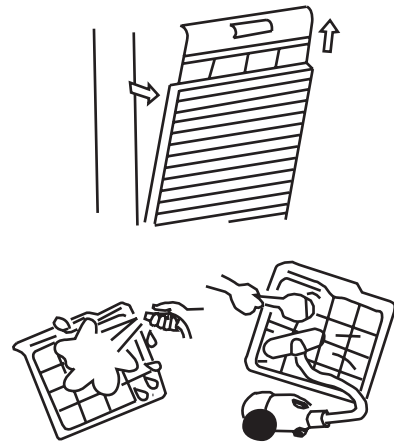

Caution:

- Don't use hot water over 40 °C, as this may cause damage to air filter.
- Wipe air filter carefully.

Indoor and outdoor cleaning

- Clean it with warm and wet cloth or with neutral detergent, then wipe it dry with clean and soft cloth.
- If air conditioner is very dirty, clean it with cloth soaked in neutral detergent, then wipe off the detergent with clean water.
- Don't use water higher than 40 °C, which will cause discoloring and deformation.
- Don't use insecticide or other chemical detergents.

■ Maintenance

After season maintenance

- Let the unit run in Fan mode for half a day in a fine weather to dry completely the unit inside.
- Turn off the unit and pull out power plug.
- There might be certain power consumption even if unit is stopped.
- Clean air filter and indoor unit, cover outdoor unit after cleaning.

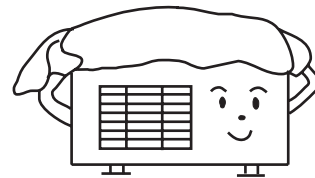
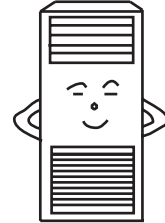

Before season maintenance

- Check if there are obstacles at inlet and outlet of indoor and outdoor unit, which will reduce unit efficiency.
- Don't fail to attach air filter after making sure it is cleaned.
- Dust will enter into unit causing damages or faults if it is running without air filter.



- To protect compressor at start, please connect external power supply to the unit 12 hrs prior to starting. Also please keep the power supply switch ON during the whole season.



■ Trouble shooting

Followings are not problems

<p>Sound of water flowings are not problems.</p>	<p>During unit start and operation or at stop, a swishing or gurgling noise may be heard. This noise is generated by refrigerant flowing in the system.</p>
<p>Sound of cracking is heard.</p>	<p>During unit operation, a cracking noise may be heard. This noise is generated by the casing expanding or shrinking because of temperatuer changes.</p>
<p>Smells are generated.</p>	<p>This is because the system circulates smells from the interior air such as the smell of cigarettes or the painting on the unit.</p>
<p>During operation, white fog or steam comes out of indoor unit.</p>	<p>When unit is running at places like restaurant where dense edible oil fumeis always exist, this will happen.</p>
<p>In cooling operation, unit switches to fan operation.</p>	<p>To prevent frost from accumulating on indoor heat exchanger, unit will switch to fan operation for a while then resume cooling operation.</p>
<p>Unit will not restart after stop. Won't start?</p>	<p>Though ON/OFF button is set to ON, unit won't resume cooling, dry or heating operation in 3 min after it is stopped, this is because of 3-min-delay protection circuit.</p> <p>Please wait 3 minutes</p>
<p>No outlet air or fan speed can't be changed in dry mode.</p>	<p>Unit will reduce fan speed repeatedly and automatically if room temp. is too low in dry operation.</p>
<p>In heating operation, water or steam are blown out of indoor unit.</p>	<p>This occurs when frost accumulated on the outdoor unit is removed. (during defrosting operation)</p>
<p>In heating operation, indoor fan won't stop even if unit is stopped.</p>	<p>After unit stops, indoor fan will go on running until indoor unit cools down.</p>

■ When problems occur?

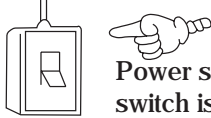
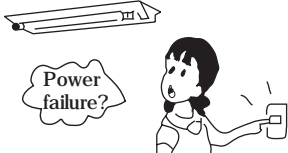
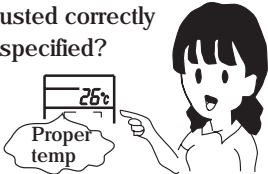
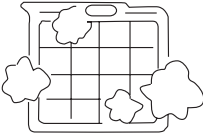
Before ask for services, please first check your unit against following.

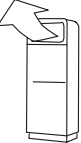
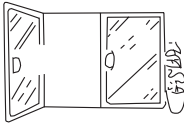
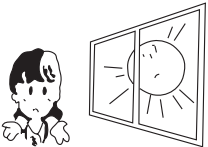
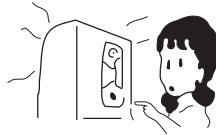
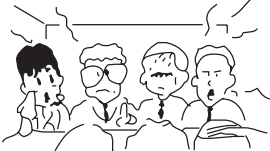
Air conditioner won't start.		
<p>Is power supply switch turned on?</p>  <p>Power supply switch is not set at ON.</p>	<p>Is city power supply normal?</p>  <p>Power failure?</p>	<p>Is leakage current breaker activated?</p> <p>This is very dangerous, please disconnect power supply immediately and contact your dealer.</p>
Poor cooling or heating		
<p>Are operation controls adjusted correctly as specified?</p>  <p>Proper temp</p>	<p>Is air filter too dirty?</p> 	<p>Are there any obstacles at inlet or outlet grill?</p> 
<p>Are horizontal louvers at up position (in heating mode)?</p> 	<p>Any doors or windows left open?</p> 	
Poor cooling		
<p>Is there any direct sunlight in the room?</p> 	<p>If there are unexpected heat sources in the room?</p> 	<p>Too many people in the room?</p> 

If your unit still can't work properly after above mentioned checks, or following problems occur, please stop it immediately and contact your dealer.

- Fuses or circuit breakers often blow out.
- Water comes out in cooling/dry operation.
- Operation is abnormal or sound is heard.

If the fuse on PC board is broken please change it with the type of 50F.3.15A/250V.

■ Indoor & outdoor unit connection

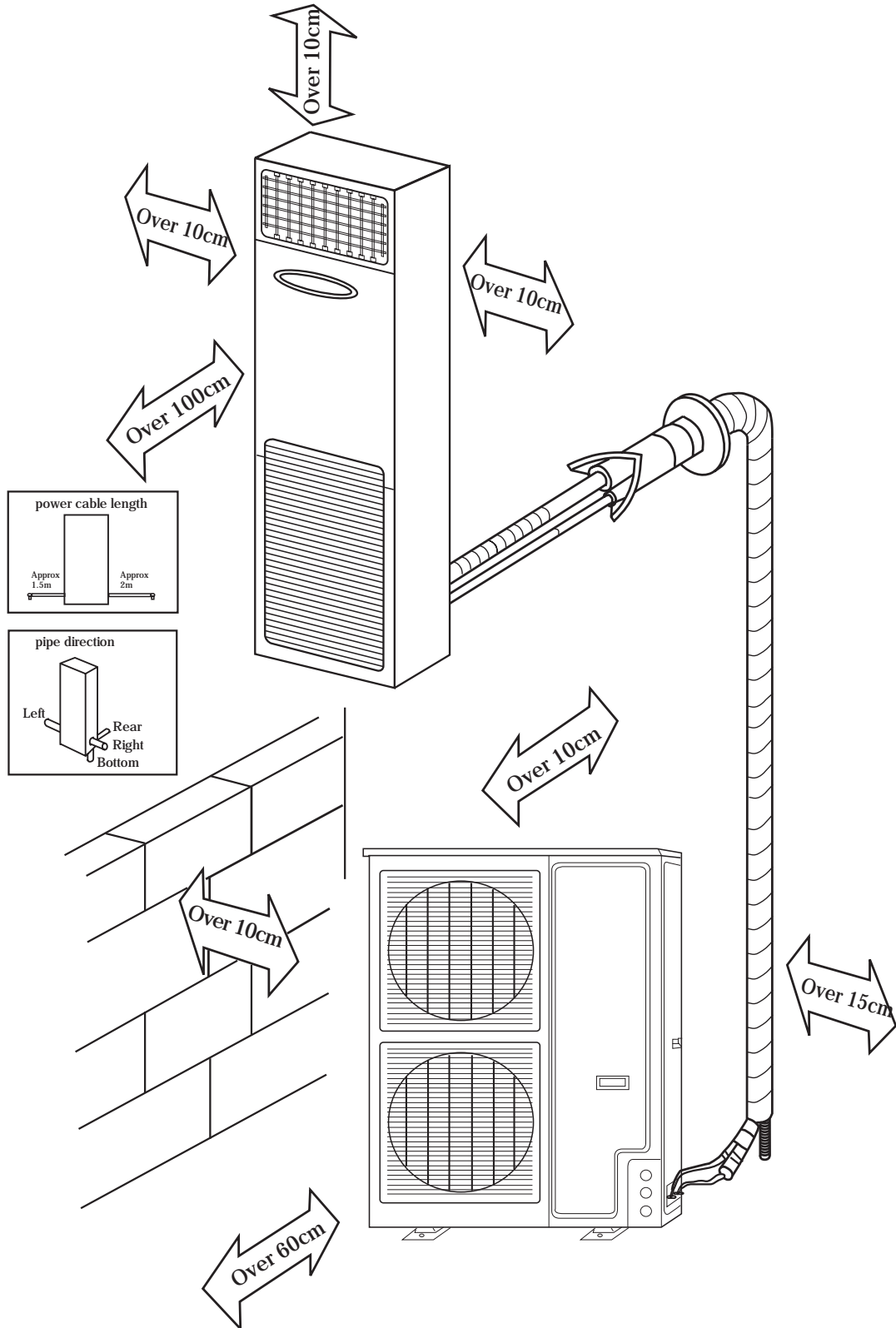

■ Indoor & outdoor unit connection

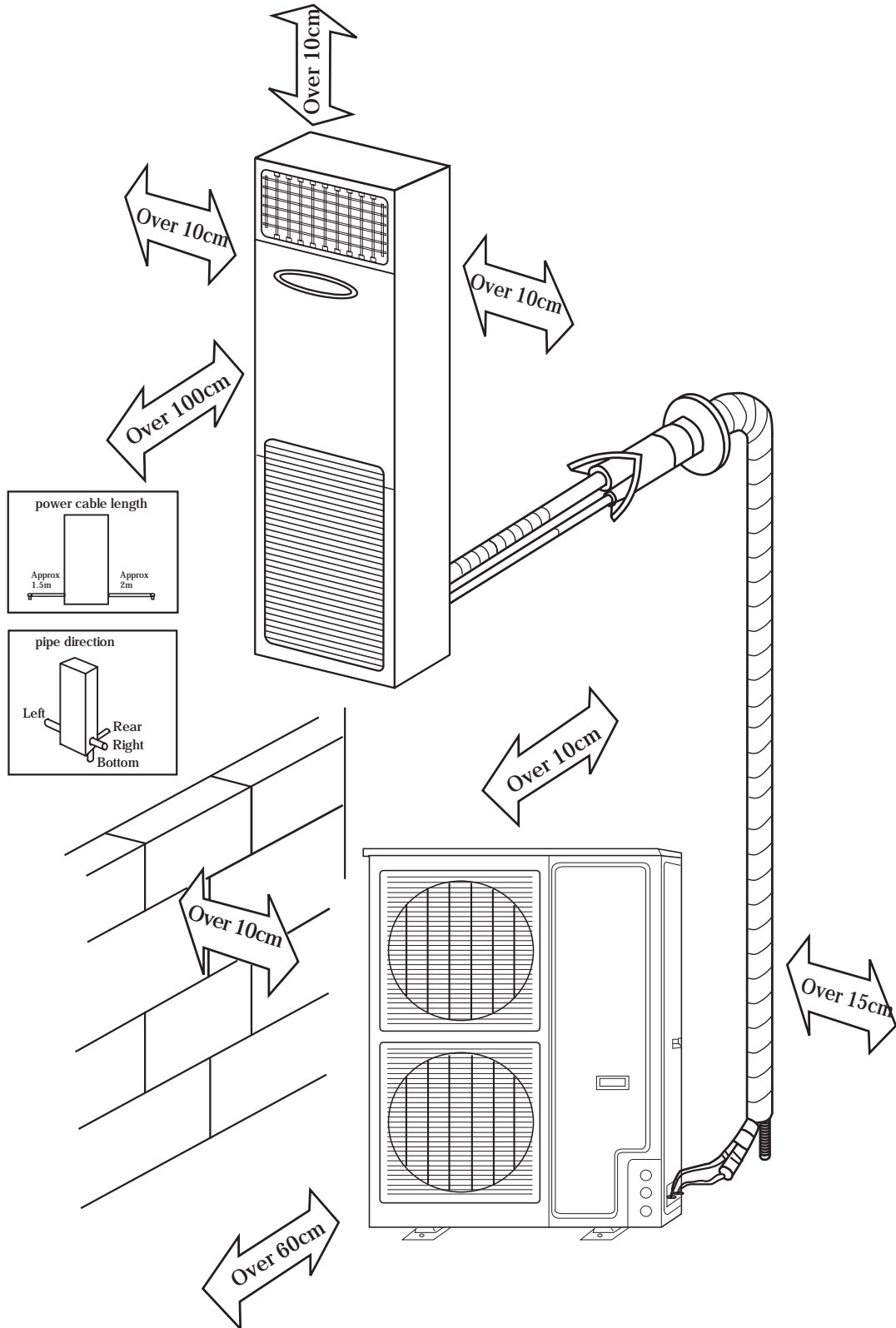

■ Tools necessary

Tools necessary

















1. Screw driver
2. Hacksaw
3. 70mm dia. hole core drill
4. Spanner (dia. 17, 27mm)
5. Spanner (14, 17, 27mm)
6. Pipe cutter
7. Flaring tool
8. Knife
9. Nipper
10. Gas leakage detector
or soap water
11. Measuring tape
12. Reamer
13. Refrigerant oil

Standard accessories

Following parts shall be field supplied

Mark	Parts name
(A)	Adhesive tape
(B)	Pipe clip
(C)	Connecting hose
(D)	Insulation material
(E)	Putty
(F)	Drain hose

Parts in the following list are accessories for the unit installation which can be used if necessary.

No.	Shape and description	QTY
①	 Remote controller	1
②	 Cement nail	3
③	 Drain hose	1
④	 Heat-insulation pipe	2
⑤	 L-shaped metal	2
⑥	 Fall-prevention fitting metal	1
⑦	 Wire clip	4
⑧	 Drain elbow	1
⑨	 Self-tapping screw	3
⑩	 Rubber pad	4
⑪	 Hexagon wrench	1
⑫	 Wall hole cover	1
⑬	 Piping hole cover	1
⑭	 Dry battery 7#	2
⑮	 Putty	1
⑯	 Plastic clamp	6
⑰	 Refrigerant oil	1

For cooling only type, drain elbow is not available

■ Installation procedures

Display of whole unit

- Try to bring the packed unit to the installation place.
- When it is inevitable to unpack the unit, be careful not to damage the unit. Wrap it with nylon etc.
- After unpacking, be sure to put it with the front side of the unit facing up.

- Note: When delivering, don't hold plastic parts like inlet and outlet grill etc.

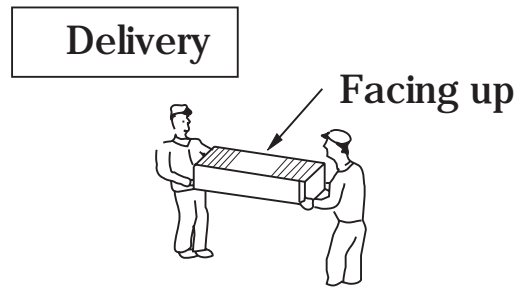

Installation of outdoor unit

Selection of installation place

- Place strong enough to support the unit and will not cause vibration and noise.
- Place where discharged wind and noise doesn't cause a nuisance to the neighbors.
- Place where is less affected by rain or direct sunlight and is sufficiently ventilated, or to install a shield.
- Place with enough space for smooth air flow.

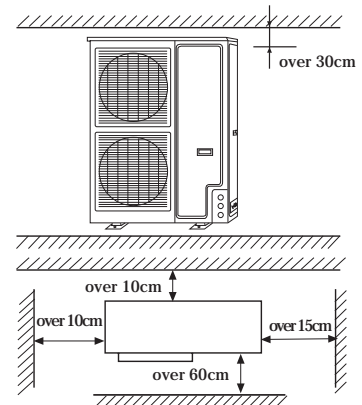

Fixing of the unit

- Fix outdoor unit using M10 bolt to concrete floor horizontally.
- If installed on the wall or on top of a roof, bracket should be fixed securely to resist earthquake or storms.
- Use rubber pad during installation against unit vibration.

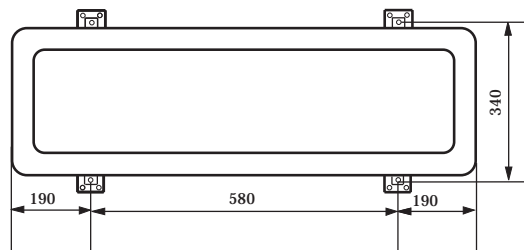

Installation dimension of outdoor unit (mm)

■ Installation procedures

Installation of indoor unit

Selection of installation place

Place where it is easy to route drainage pipe and outdoor piping.

Place away from heat source and with less direct sunlight.

Place where cool and warm air could be delivered evenly to every corner of the room.

Place near power supply socket. Leave enough space around the unit (refer to installation drawings).

Fixing of the unit

1. Position of the wall hole

Wall hole should be decided according to installation place and piping direction. (refer to installation drawings)

2. Making a wall hole

Drill a hole of 70mm dia. with a little slope towards outside.

Install piping hole cover and seal it with putty after installation.

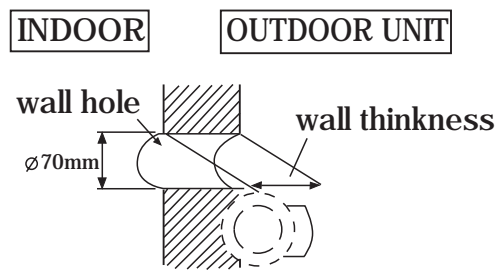

(Cross section of wall hole)

Fixing of indoor unit

To prevent it from fall off, please fix the unit with fall-prevention fitting at wall and L-shaped metal at floor.

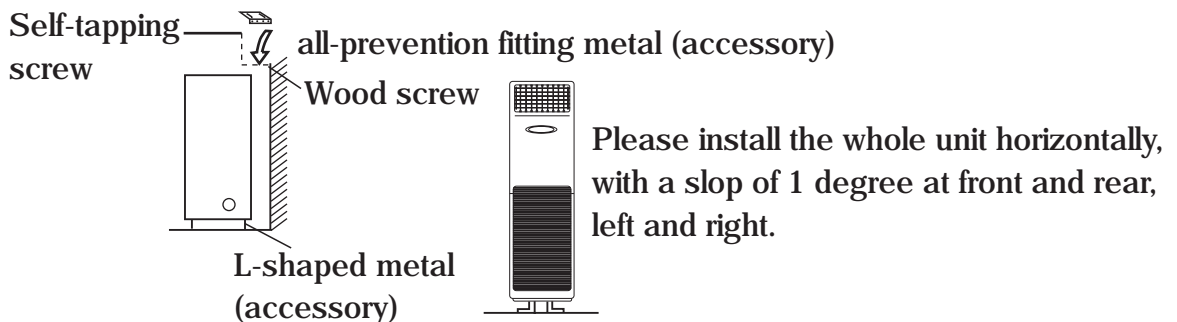

■ Installation procedures

Installation of fall-prevention fitting metal:

Fix the fitting metal to the wall by screws so that there is no clearance between them. With the unit set up vertically, fix the fitting metal to the unit with screws while making an adjustment at the long portion of the hole so that there is no clearance between the upper surface and the fitting metal.

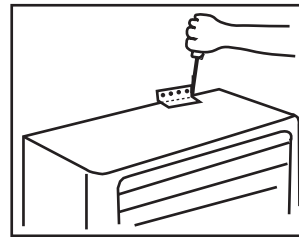
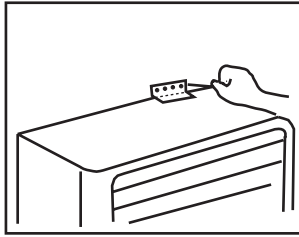

Installation of L-shaped metal

Fix to the unit by screws so that there is no clearance between the fitting metal and the unit.

After confirming that the unit has been set up vertically to the floor, fix it to the floor by bolt.

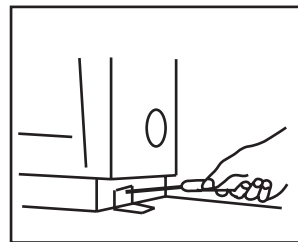
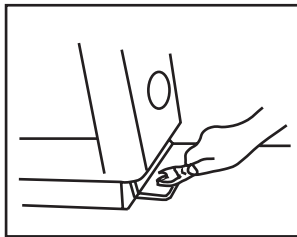

Piping connection

1. Connecting method

Apply refrigerant oil at half union and flare nut.

To bend a pipe, give the roundness as large as possible not to crash the pipe.

When connecting pipe, hold the pipe centre to centre then screw nut on by hand, refer to Fig.

Be careful not to let foreign matters, such as sands enter the pipe.

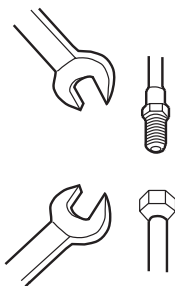

Forced fastening without centering may damage the threads and cause a gas leakage.

Pipe dia	Fastening torque
Liquid pipe 9.52mm(3/8")	42N·m
Gas pipe 19.05mm(5/8")	110N·m

■ Installation procedures

2. Piping connection of indoor unit

Arrangement of piping and drainage pipe

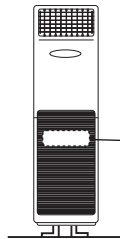

After opening inlet grill, you will see a control box as shown in the Fig.

Remove the cover before working.

Cut away, with a hammer or a saw, the lid for piping according to piping direction.

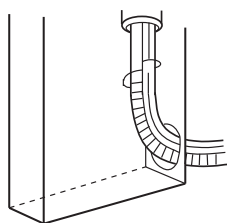

Insulation material

Copper tube

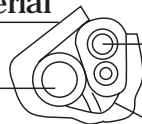

Drain hose

Connecting electric cable for indoor and outdoor unit

According to the piping method, connect the piping on indoor unit with union of connecting pipe.

Arrange the piping as per the wall hole and bind drain hose connecting electric cable and piping together with polyethylene tape.

Insert the bound piping connecting electric cable and drain hose through wall hole to connect with outdoor unit.

Arrangement of drain hose

- Drain hose shall be placed in under place.
- There should be a slope when arrange drain hose. Avoid up and down waves in drain hose.

Indoor unit

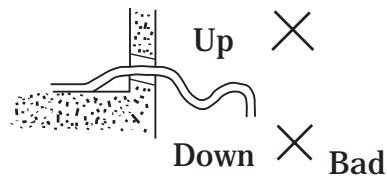
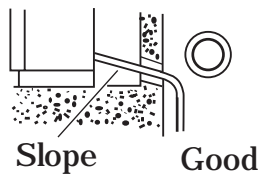

If humidity is high, drain pipe(especially in room and indoor unit) must be covered with insulation material.

■ Installation procedures

3. Piping connection of outdoor unit.

Connect the connecting pipe and inlet and outlet liquid pipe according to the piping method.

4. Purging method

Discharge the air out of the indoor unit and the refrigerant pipe by vacuumizing

- (1) Fasten all the nuts of the indoor and outdoor pipes to make these parts out of leakage.
- (2) Under the condition of the complete close of the indoor and outdoor valve center (both liquid and gas side),dismount the repair valve cap.Vacuumizing through the charge mouth of the repair valve.
- (3) After vacuumizing fasten the repair valve,and dismount the cap of the big and small stop valve,then loosen the stop valve center completely and fasten the big and small stop valve.

5.Extra charging amount of the refrigerant

When piping is longer than 5 m, charge additional refrigerant specified in this list.

Pipe length	5m	10m	15m	20m	25m	30m
Refrigerant charge (g)	—	250	500	750	1000	1250

■ Installation procedures

Electric wiring

Note:

- Electric wiring must be done by qualified person.
- Use copper wire only, the parameter of connecting cable is H07RN-F4 X 0.75mm².
- The power cable should be over 3G2.5mm², the power cable is self-provided.

Wiring of indoor unit

- Insert the cable from outside the wall hole where piping already exist.
- Pull it out from front.
- Loosen terminal screws and insert cable end fully into terminal block, then tighten it.
- Pull the cable gently to make sure it is tight.
- Replace cover after wiring.

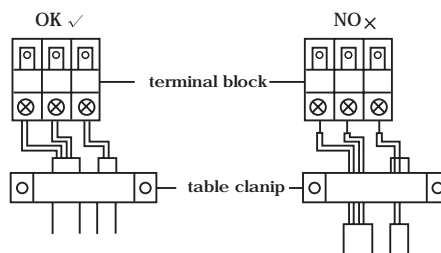
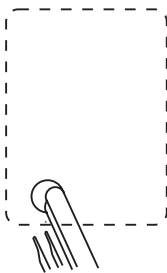

Wiring of outdoor unit

- Insert the cable from inside the wall hole where piping already exists.
- Pull it out from front.
- Loose terminal screw and insert cable end fully into terminal block, then tighten it.
- Pull the cable gently to make sure it is tight.
- Replace cover after wiring.

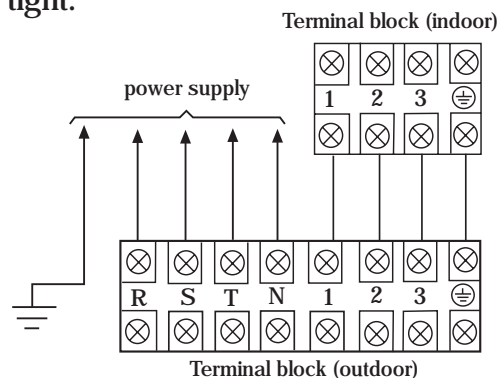
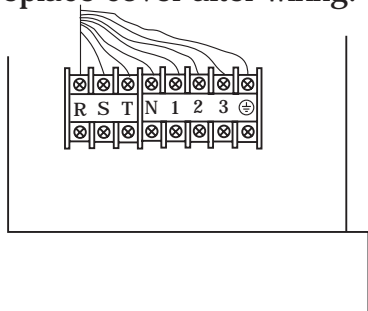

Note:

- When connecting indoor and outdoor wire, check the number on indoor and outdoor terminal blocks. Terminals of same number and same color shall be connected by the same wire.
- Incorrect wiring may damage air conditioner's controller or cause operation failure.

Others

1. Power supply



- Air conditioner must use an exclusive line (over 30A)
- When installation air conditioner in a wet place, try to use a circuit breaker against Current leakage.
- For installation in other places, use circuit breaker as far as possible.
- The breaker of the air conditioner should be all-pole switch ; and the distance between its two contacts should be no less 3 mm.
- Such means for disconnection must be incorporation in the fixed wiring

2. Pipe cutting and flaring

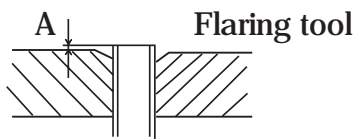
- Be sure to carry out deburring after pipe cutting with a pipe cutter.
- Insert flaring tool to make a flare.

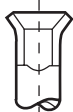
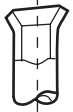
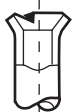

	Pipe dia.	Dimension A(mm)
Liquid pipe	∅ 9.52mm (3/8")	1.0 ~ 1.2
Gas pipe	∅ 19.05mm (3/4")	1.4 ~ 2.2

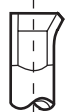
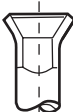
Correct	Incorrect				
					
	Lean	Damaged flare	Crack	Partial	Too outside

Installation inspection and test run:

Please operate unit according to this Manual.

Items to be checked during test run. Please made a "√" in "□"

- Are there any gas leakage?
- How is insulation at piping connection carried out?
- Are electric wires of indoor and outdoor unit firmly inserted into terminal block?
- Is electric wiring of indoor and outdoor securely fixed?
- Is draminage securely carried out?
- Is earth line (grounding) securely connected?
- Is power supply voltage abided by the code?
- Is there any noise?
- Is control display normal?
- Is cooling operation normal?
- Is room temp. regulator normal?