



ENGLISH

INDONESIA

CD/CASSETTE RECEIVER

KW-XC888

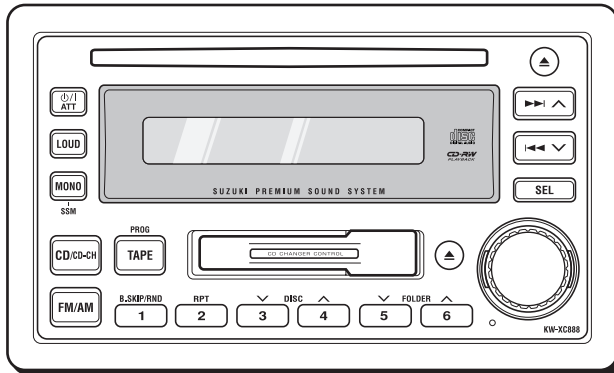

COMPACT
disc
DIGITAL AUDIO

CD-RW
PLAYBACK

SUZUKI PREMIUM SOUND SYSTEM



INSTRUCTIONS INSTRUKSI

LVT1139 - 002A
(UN)

IMPORTANT FOR LASER PRODUCTS

1. CLASS 1 LASER PRODUCT
2. **CAUTION:** Do not open the top cover. There are no user serviceable parts inside unit; leave all servicing to qualified service personnel.
3. **CAUTION:** Visible and invisible laser radiation when open and interlock failed or defeated. Avoid direct exposure to beam.
4. REPRODUCTION OF LABEL: CAUTION LABEL, PLACED OUTSIDE THE UNIT.

CAUTION : Visible and invisible laser radiation when open and interlock failed or defeated. AVOID DIRECT EXPOSURE TO BEAM. (e)	ADVARSEL : Synlig og usynlig laserstråling når maskinen er åpen eller interlocken fejler. Unngå direkte eksponering til stråling. (d)	VARNING : Synlig och osynlig laserstrålning när den öppnas och spärren är urkopplad. Beträkta ej strålen. (d)	VARO : Avtättessa ja suojalukitus ohjettuna tai viallisena ollet allina näkyväille ja näkymättömille lasersäteilylle. Vältä säteien kohdistumista suoraan itseesi. (f)
--	---	---	---

CAUTION on Volume Setting

CDs produce very little noise compared with other sources. If the volume level is adjusted for the tuner, for example, the speakers may be damaged by the sudden increase in the output level. Therefore, lower the volume before playing a CD and adjust it as required during playback.

How to reset your unit

Press the reset button on the front panel using a ball-point pen or similar tool.

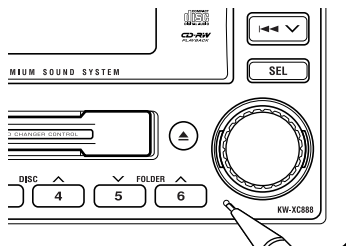

Note:

Your preset adjustments—such as preset channels or sound adjustments—will be erased.

CONTENTS

How to reset your unit	2
LOCATION OF THE BUTTONS	4
BASIC OPERATIONS	5
RADIO OPERATIONS	6
Listening to the radio	6
Storing stations in memory	7
Tuning in to a preset station	8
Selecting FM reception mode	8
CD OPERATIONS	9
Playing a CD	9
Locating a track or a particular portion on a CD	10
Selecting CD playback modes	10
TAPE OPERATIONS	11
Listening to a tape	11
Finding the beginning of a tune	12
Other convenient tape functions	13
SOUND ADJUSTMENTS	14
CD CHANGER OPERATIONS	15
About MP3 discs	15
Connecting the CD changer	16
Playing discs	16
Locating a track or a particular portion on a disc	17
Locating a disc in the magazine	17
Locating a folder on a disc	18
Selecting the playback modes	18
ADDITIONAL INFORMATION	19
Handling cassettes	19
Handling discs	20
TROUBLESHOOTING	21
SPECIFICATIONS	23

BEFORE USE

**For safety....*

- Do not raise the volume level too much, as this will block outside sounds, making driving dangerous.
- Stop the car before performing any complicated operations.

**Temperature inside the car....*

If you have parked the car for a long time in hot or cold weather, wait until the temperature in the car becomes normal before operating the unit.



LOCATION OF THE BUTTONS

ENGLISH

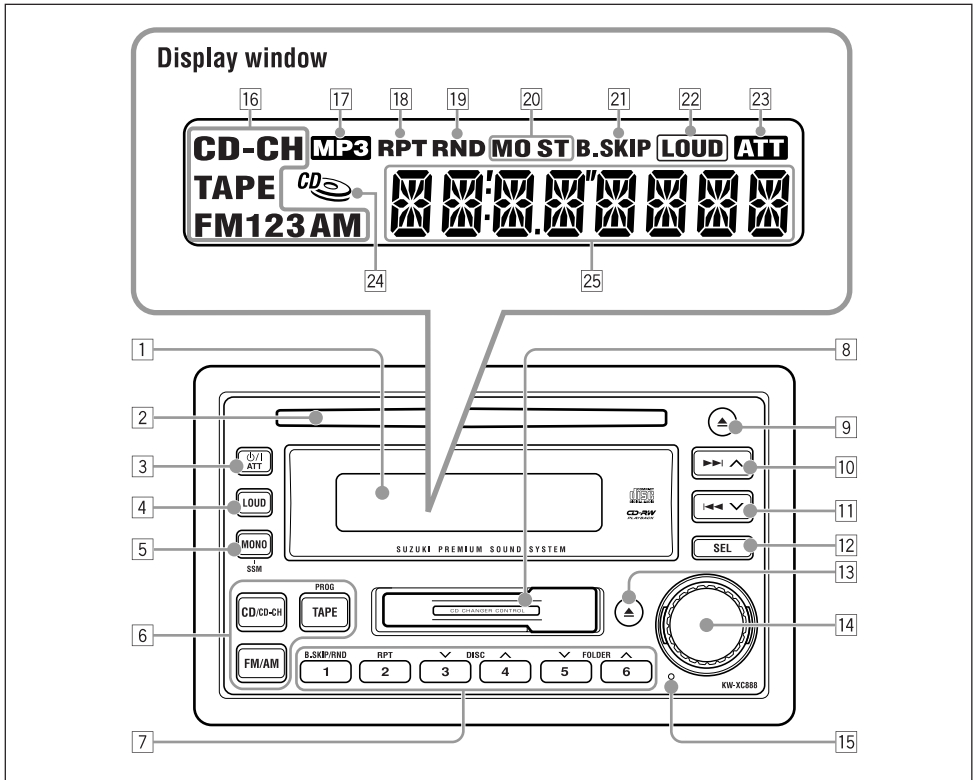

Control Panel

- 1 Display window
- 2 CD loading slot
- 3 **⏻/I** /ATT (standby/on/attenuator) button
- 4 LOUD (loudness) button
- 5 MONO (monaural) /SSM button
- 6 Source buttons
 - CD/CD-CH button
 - FM/AM button
 - TAPE (PROG) button
- 7 Number buttons
 - B.SKIP/RND (blank skip/random) button
 - RPT (repeat) button
 - **▼** DISC button
 - DISC **▲** button
 - **▼** FOLDER button
 - FOLDER **▲** button
- 8 Cassette compartment
- 9 CD **▲** (eject) button
- 10 **▶▶** **▲** button
- 11 **◀◀** **▼** button

- 12 SEL (select) button
- 13 Tape **▲** (eject) button
- 14 Control dial
- 15 Reset button

Display window

- 16 Source indicators
CD, CD-CH (CD-changer), TAPE, FM1, FM2, FM3, AM
- 17 MP3 indicator
- 18 RPT (repeat) indicator
- 19 RND (random) indicator
- 20 Tuner reception indicators
MO (monaural), ST (stereo)
- 21 B.SKIP (blank skip) indicator
- 22 LOUD (loudness) indicator
- 23 ATT (attenuator) indicator
- 24 CD-in indicator
- 25 Main display

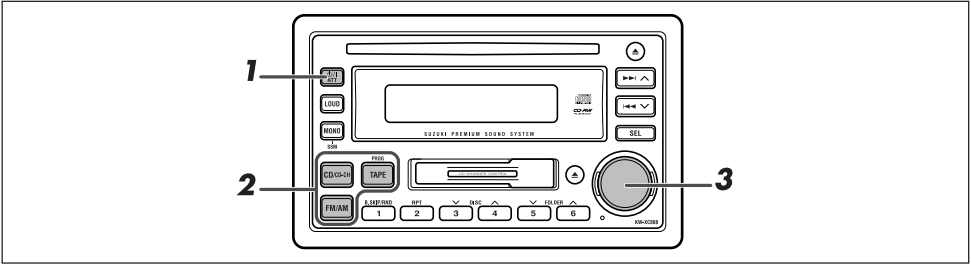

1 Turn on the power.



Note on One-Touch Operation:

When you select a source in step 2 below, the power automatically comes on. You do not have to press this button to turn on the power.

3 Adjust the volume.

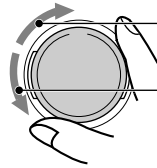

To increase the volume

To decrease the volume



Volume level

2 Select the source.



- Each time you press CD/CD-CH, the source alternates between CD* and CD-changer**.



- Each time you press FM/AM, the band changes to FM (FM1, FM2, FM3) and AM.



- Press TAPE (PROG), so that the source is selected as TAPE***.

4 Adjust the sound as you want (see page 14).

To drop the volume immediately

Press **CD/ATT** briefly while listening to any source. The ATT indicator starts flashing on the display, and the volume level will drop immediately.

To resume the previous volume level, press the button briefly again.

To turn off the power

Press **CD/ATT** for more than 1 second.

- **If you turn off the power while listening to a CD**, the CD play will start from where playback has been stopped previously, next time you turn on the power.
- **If you turn off the ignition key without turning off this unit**, the unit will automatically turn on when you turn on the ignition key next time. If the last selected source is ready for playback (ex. a CD or a tape is in the unit), playback starts automatically.

* If a disc is not in the loading slot, you cannot select CD as the source to play. ("NO DISC" will appear on the display.)

** Without connecting the CD changer, you cannot select it as the source to play.

*** If a cassette is not in the cassette compartment, you cannot select TAPE as the source to play. ("NO TAPE" will appear on the display.)

To operate the tuner, see pages 6 – 8.

To play the CD, see pages 9 and 10.

To operate the tape deck, see pages 11 – 13.

To operate the CD changer, see pages 15 – 18.



RADIO OPERATIONS

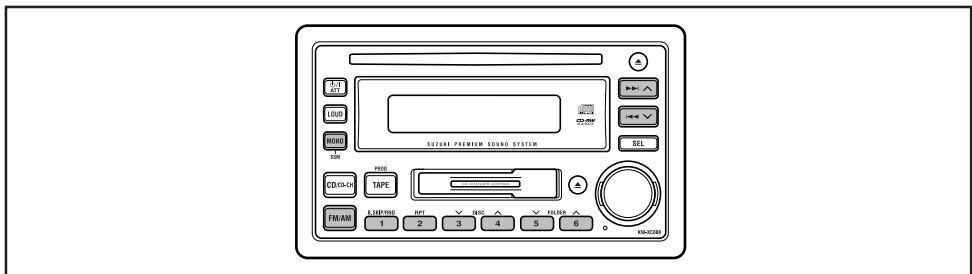

Listening to the radio

You can use either automatic searching or manual searching to tune in to a particular station.

Searching for a station automatically: Auto search

- 1 Select the band (FM1, FM2, FM3 or AM).



Note:

This receiver has three FM bands (FM1, FM2, and FM3). You can use any one of them to listen to an FM broadcast.



Selected band appears.

- 2 Start searching for a station.

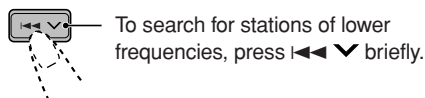
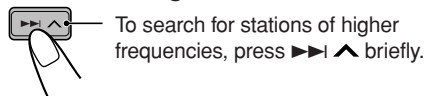

When a station is received, searching stops.

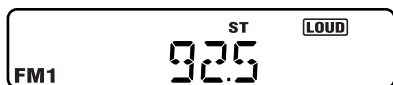

ST indicator lights up when receiving an FM broadcast in stereo.

To stop searching before a station is received, press the same button you have pressed for searching.

Searching for a station manually: Manual search

- 1 Select the band (FM1, FM2, FM3, or AM).



- 2 Press and hold **▶▶|▲** or **◀◀|▼** until "M" (manual) starts flashing on the display.

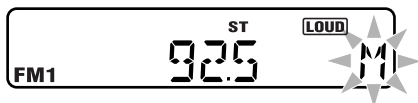

- 3 Tune in to a station you want while "M" is flashing.

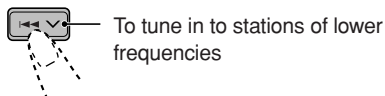
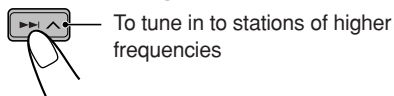

Notes:

- If you release your finger from the button, the manual search will automatically turn off after 5 seconds.
- If you hold down the button, the frequency keeps changing (in 50 kHz intervals for FM and 9 kHz for AM) until you release the button.

Storing stations in memory

You can use one of the following methods to store broadcasting stations in memory.

- Automatic preset: SSM (Strong-station Sequential Memory)
- Manual preset

Automatic preset: SSM

You can preset up to 6 local stations in each FM band (FM1, FM2, and FM3).

1 Select the band (FM1, FM2, or FM3).



2 Press MONO/SSM for more than 1 second.

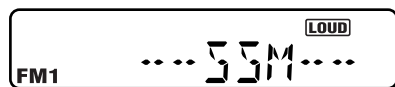

“SSM” appears, then disappears when automatic preset is over.

Local stations with the strongest signals are searched for and stored automatically in the band you have selected (FM1, FM2, and FM3). These stations are preset in the number buttons—No. 1 (lowest frequency) to No. 6 (highest frequency).

When automatic preset is over, the station stored in the number 1 button will be automatically tuned in.

Manual preset

You can preset up to 6 stations in each band (FM1, FM2, FM3, and AM) manually.

Ex.: Storing an FM station of 92.5 MHz into the preset channel number 1 of the FM1 band

1 Select the FM1 band.



2 Tune in to a station (in this example, of 92.5 MHz).

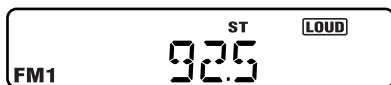
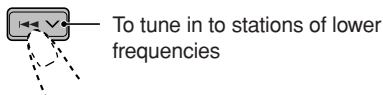
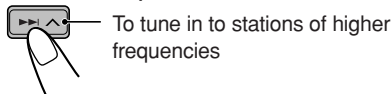

3 Press and hold the number button (in this example, 1) for more than 2 seconds.

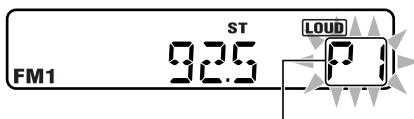

Preset number flashes for a while.



4 Repeat the above procedure to store other stations into other preset numbers.

Notes:

- A previously preset station is erased when a new station is stored in the same preset number.
- Preset stations are erased when power supply to the memory circuit is interrupted (for example, during battery replacement). If this occurs, preset the stations again.

Tuning in to a preset station

You can easily tune in to a preset station. Remember that you must store stations first. If you have not stored them yet, see page 7.

1 Select the band (FM1, FM2, FM3, or AM) you want.

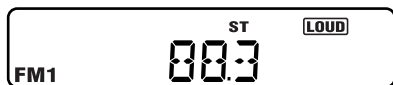

2 Select the number (1 – 6) for the preset station you want.

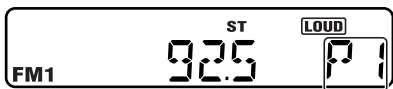

Preset number

EX.: When you press number button 1

Selecting FM reception mode

When an FM stereo broadcast is hard to receive:



Press MONO/SSM briefly so that MO indicator lights up on the display ("MONO" appears on the display).

Each time you press the button, the MO indicator goes on and off alternately.

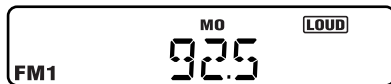
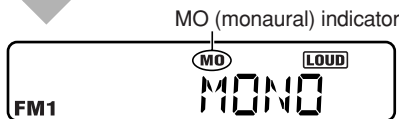
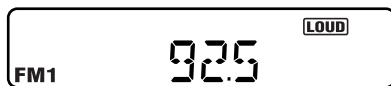

When the MO indicator is lit, the sound you hear becomes monaural but reception will be improved.

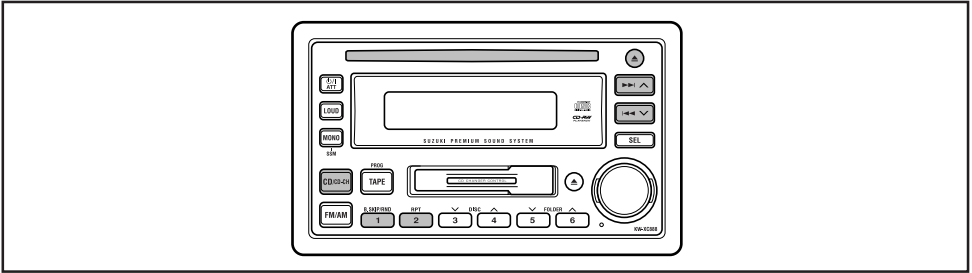

Playing a CD

Insert a CD into the loading slot.

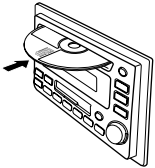

The unit turns on, draws in the CD and starts playback automatically (the CD-in indicator and "LOADING" flash on the display).

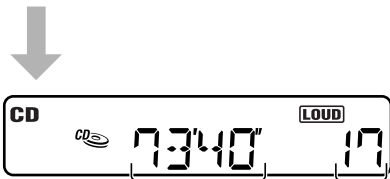
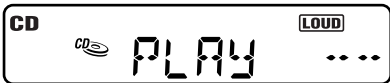
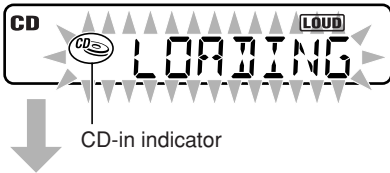

Total playing time of the inserted disc Total track number of the inserted disc



Elapsed playing time Current track number

Note on One-Touch Operation:

When a CD is already in the loading slot, pressing CD/CD-CH turns on the unit and starts playback automatically.

To stop play and eject the CD



Press CD ▲. CD play stops and the CD automatically ejects from the loading slot (the CD-in indicator and "EJECT" flash on the display). The source changes to the last selected source.



Notes:

- When a CD is inserted upside down, the CD automatically ejects.
- If the ejected disc is not removed for about 15 seconds, the disc is automatically inserted again into the loading slot to protect it from dust. (CD play will not start this time.)
- You can eject the CD even when the ignition key is turned off. (However, you cannot load the CD into the loading slot when the ignition key is turned off.)
- If you change the source, CD play also stops (without ejecting the disc).

Next time you select "CD" as the source, CD play starts from where playback had been stopped previously.



Locating a track or a particular portion on a CD

To fast-forward or reverse the track

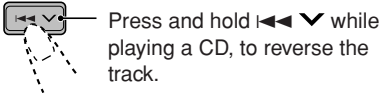
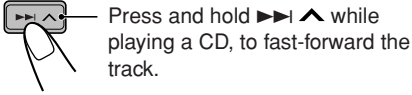

To go to the next tracks or the previous track

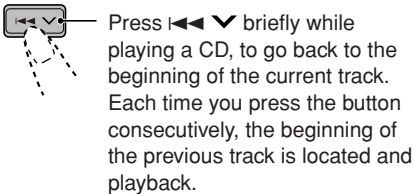
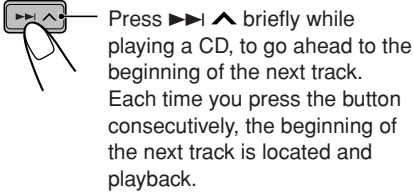

Selecting CD playback modes

To play back tracks at random (Random Play)

You can play back all tracks on the CD at random.

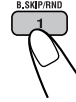

Press **B.SKIP/RND** so that “**DISC RND**” appears on the display. Each time you press the button, CD random play mode turns on and off alternately.

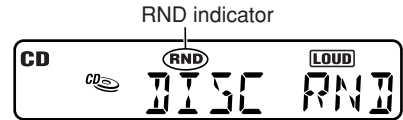

When CD random mode is turned on, the **RND** indicator lights up on the display and a randomly selected track starts playing.

To play back tracks repeatedly (Repeat Play)

You can play back the current track repeatedly.



Press **RPT** so that “**TRK RPT**” appears on the display. Each time you press the button, CD repeat play mode turns on and off alternately.

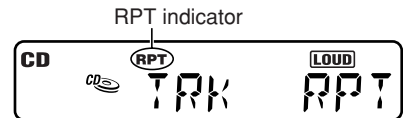

When CD repeat mode is turned on, the **RPT** indicator lights up on the display.

TAPE OPERATIONS

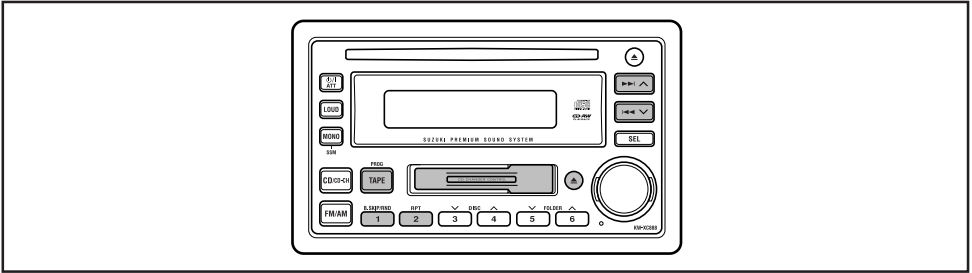

Listening to a tape

You can play back type I (normal) tapes.

1 Insert a cassette into the cassette compartment.

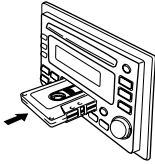

The unit turns on and tape play starts automatically ("LOADING" flashes on the display).



When one side of the tape reaches its end during play, the other side of the tape automatically starts playing. (Auto Reverse)

Note on One-Touch Operation:

When a cassette is already in the cassette compartment, pressing TAPE (PROG) turns on the unit and starts tape play automatically.

2 Select the tape direction.



Each time you press the button, the tape direction changes alternately.

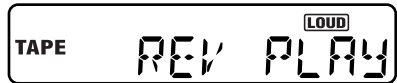

To stop play and eject the cassette

Press Tape ▲.

Tape play stops and the cassette automatically ejects from the cassette compartment ("EJECT" flashes on the display).



Notes:

- If you change the source, the tape play also stops (without ejecting the cassette this time).
- You can also eject the cassette by pressing Tape ▲ with the ignition key turned off. (However, you cannot load the cassette into the cassette compartment when the ignition key is turned off.)



To fast-forward and rewind a tape



Press ►►▲ for more than 1 second to fast-forward the tape. When the tape reaches its end, the tape is reversed and playback starts from the beginning of the other side.



Current tape direction

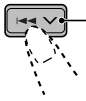

Press ◀◀▼ for more than 1 second to rewind the tape. When the tape reaches its end, playback of the same side starts.



Current tape direction

To stop fast forward or rewind at any position on the tape, press TAPE (PROG).

Tape play starts from that position on the tape.

Note:

When the tape reaches its end while fast-forwarding, the tape direction will be changed automatically.

Finding the beginning of a tune

Multi Music Scan allows you to automatically start playback from the beginning of a specified tune. You can specify up to 9 tunes ahead of or before the current tune.

During playback

Specify where (how many tunes ahead of or before the current tune) the tune you want is located.



Press ►►▲ repeatedly to locate a tune ahead of the current tune on the tape.



Press ◀◀▼ repeatedly to locate a tune before the current tune on the tape.



When the beginning of the specified tune is located, playback starts automatically.

Notes:

- While locating a specified tune:
 - If the tape is rewound to its beginning, playback starts from the beginning of that side.
 - If the tape is fast-forwarded to the end, it is reversed and played from the beginning of the other side.
- In the following cases, Multi Music Scan may not operate correctly:
 - Tapes with tunes having long pianissimo passages (very quiet parts) or non-recorded portions.
 - Tapes with short non-recorded sections.
 - Tapes with high level noise or humming between tunes.



Other convenient tape functions

Skipping blank portions on the tape

You can skip blank portions between the tunes (Blank Skip).



Press B.SKIP/RND so that "B.SKIP" appears on the display. Each time you press the button, skip function mode turns on and off alternately.

B.SKIP indicator

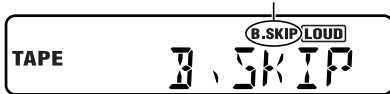

When this function is on, the B.SKIP indicator lights up on the display and the unit skips blank portions of 15 seconds or more, fast-forwards to the next tune, then starts playing it. While the unit is skipping blank portions, the B.SKIP indicator flashes.

Playing the current tune repeatedly

You can play the current tune repeatedly (Repeat Play).



Press RPT so that "REPEAT" appears on the display. Each time you press the button, repeat play mode turns on and off alternately.



When the repeat mode is turned on, the RPT indicator lights up on the display.

Notes:

- In the following cases, Blank Skip and Repeat Play may not operate correctly:
 - Tapes with tunes having long pianissimo passages (very quiet parts) or non-recorded portions.
 - Tapes with short non-recorded sections.
 - Tapes with high level noise or humming between tunes.
- In the following cases, Repeat Play function for tape will be turned off.
 - If the source is changed to any other than "TAPE."
 - If the cassette is ejected.
 - If the unit is turned off.



SOUND ADJUSTMENTS

ENGLISH

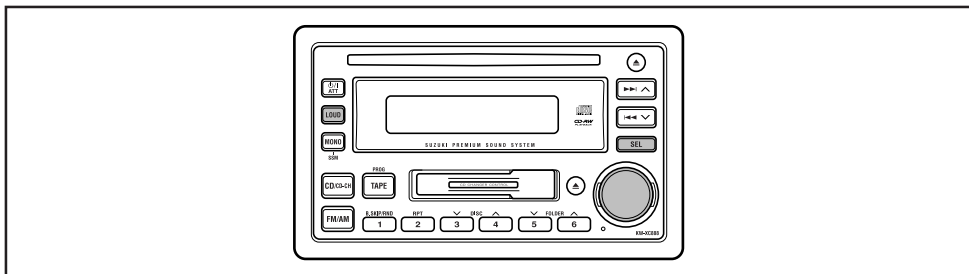

You can adjust the sound characteristics to your preference.

1 Select the item you want to adjust.



Each time you press the button, the adjustable items change as follows:

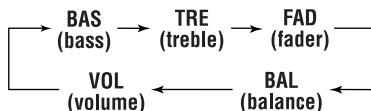

Indication	To do:	Range
BAS	Adjust the bass.	-06 (min.) +06 (max.)
TRE	Adjust the treble.	-06 (min.) +06 (max.)
FAD*1	Adjust the front and rear speaker balance.	R06 (Rear only) F06 (Front only)
BAL	Adjust the left and right speaker balance.	L06 (Left only) R06 (Right only)
VOL*2	Adjust the volume.	00 (min.) 50 (max.)

*1 If you are using a two-speaker system, set the fader level to "00."

*2 Normally the control dial works for volume adjustment. So you do not have to select "VOL" to adjust the volume level.

2 Adjust the level.

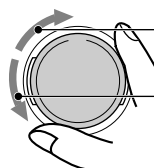

To increase the level

To decrease the level

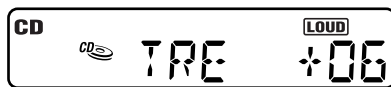

Ex.: When you adjust "TRE" (treble)

3 Repeat steps 1 and 2 to adjust the other items.

While listening at a low volume level:

You can boost low and high frequencies to produce a well-balanced sound at low volume level.



Press LOUD so that "LOUD" appears on the display.

Each time you press the button, the loudness mode turns on and off alternately.

LOUD indicator



When the loudness mode is turned on, the LOUD indicator lights up on the display.

CD CHANGER OPERATIONS

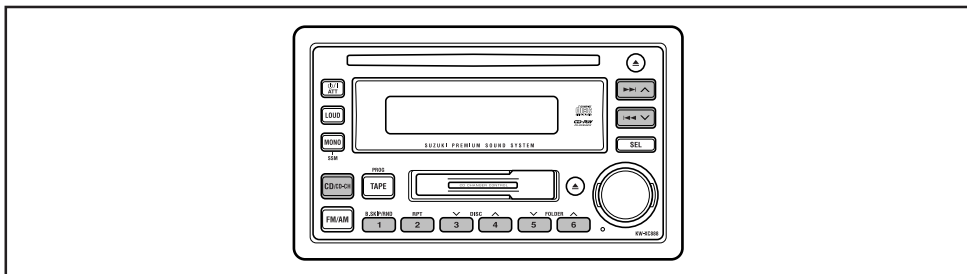

We recommend that you use the JVC MP3-compatible CD changer with this unit.

This unit cannot read MP3 “**tracks**” (word “file” is not used to indicate MP3 files, “track” is used in this manual) recorded on CD-Rs, CD-RWs or CD-ROMs. However, by using the JVC MP3-compatible CD changer, you can playback your original CD-Rs and CD-RWs recorded either in audio CD format or in MP3 format.

- If you have another CD changer, consult your car dealer or JVC car audio dealer for connections.

About MP3 discs

What is MP3?

MP3 is an abbreviation of Motion Picture Experts Group (or MPEG) Audio Layer 3. MP3 is simply a file format with a data compression ratio of 1:10 (128 Kbps*). That means, by using MP3 format, one CD-R or CD-RW can contain 10 times as much data volume as a regular CD can.

* *Bit rate is the average number of bits that one second of audio data will consume. The unit used is Kbps. To get a better audio quality, choose a higher bit rate. The most popular bit rate for encoding is 128 Kbps.*

Incompatible with ID3-tag

ID3-tag is extra information data stored within an MP3 track such as album title, performer name, song title, recording year, music genre and a brief comment.

- This unit cannot show ID3-tag on the display.

How are MP3 tracks recorded?

MP3 tracks can be recorded in “**folders**.”

During recording, the tracks and folders can be arranged in a way similar to arranging tracks and folders of computer data.

“**Root**” is similar to the root of a tree. Every track and folder can be linked to and be accessed from the root.

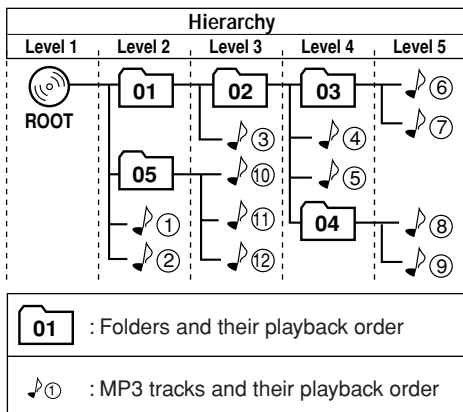



Connecting the CD changer

Before connecting the CD changer

- To prevent short circuits, it is recommended to disconnect the car battery's negative terminal and make all electrical connections before connecting the CD changer.
- When mounting the unit removed from your car, be sure to use the screws provided, as instructed. If other screws are used, there is a possibility that parts could become loose or damaged.
- When tightening screws or bolts, be careful not to pinch any connection cord.
- If you are not sure how to connect the CD changer correctly, consult your car dealer or JVC car audio dealer, or have it installed by a qualified technician. Refer also to the instructions supplied for the CD changer.

The following illustration shows the connection to JVC CD changer. If you have another CD changer, consult your car dealer or JVC car audio dealer for connections.

1 Remove this unit from your car.

- Be sure to keep all the screws and parts removed from your car.

2 Connect this unit to JVC CD changer with the connection cord supplied for the CD changer.

Connection cord supplied for the CD changer

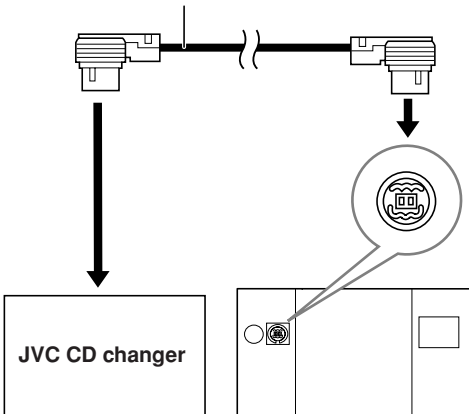

KW-XC888

3 Re-install this unit to your car using the screws removed in step 1.

- For JVC CD changer installation, refer to the instructions supplied for JVC CD changer.

Playing discs

Select the CD changer (CD-CH).

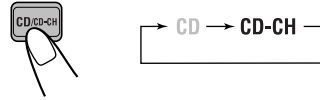

Note on One-Touch Operation:

When you press CD/CD-CH, the power automatically comes on. You do not have to press **⏻** / **ATT** to turn on the power.

- If you change the source, CD changer play also stops. Next time you select the CD changer as the source, CD changer play starts from where playback has been stopped previously.

When the current disc is a CD:

Playback starts from the first track of the current disc.

The display changes to show the following:

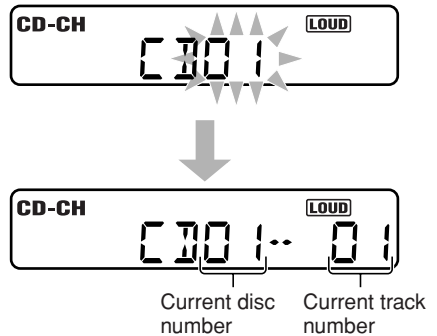

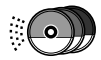

When the current disc is an MP3 disc:

Playback starts from the first folder of the current disc once track check is completed.

The display changes to show the following:



Current disc number

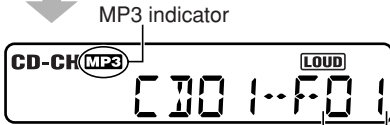

MP3 indicator

Current folder number



Current track number

Locating a track or a particular portion on a disc

To fast-forward or reverse the track



Press and hold **▶▶|▲** while playing a disc, to fast-forward the track.



Press and hold **◀◀|▼** while playing a disc, to reverse the track.

To go to the next or previous tracks



Press **▶▶|▲** briefly while playing a disc, to go ahead to the beginning of the next track. Each time you press the button consecutively, the beginning of the next track is located and playback.



Press **◀◀|▼** briefly while playing a disc, to go ahead to the beginning of the current track. Each time you press the button consecutively, the beginning of the previous track is located and playback.

Locating a disc in the magazine

To skip to the next or previous discs



Press **DISC ▲** while playing a disc, to go to the next disc. Each time you press the button consecutively, the next disc is located and the first track in the disc starts playback.



Press **▼ DISC** while playing a disc, to go the previous disc. Each time you press the button consecutively, the previous disc is located and the first track in the disc starts playback.



Locating a folder on a disc

To skip to the next or previous folders (only for MP3 discs)

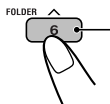

Press FOLDER while playing an MP3 disc, to go to the next folder.

Each time you press the button consecutively, the next folder is located and the first track in the folder starts playback.

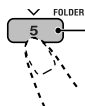

Press FOLDER while playing an MP3 disc, to go the previous folder.

Each time you press the button consecutively, the previous folder is located and the first track in the folder starts playback.

Selecting the playback modes

To play back tracks at random (Disc Random/Magazine Random Play)

You can play back tracks on a disc or on all loaded discs at random.



Each time you press the button, the random play mode changes as follows:

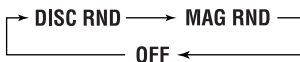

Ex.: When you select "DISC RND"

Note:

MP3 indicator also lights up if the current playing disc is an MP3 disc.

Mode	RND Indicator	Plays at random
DISC RND	Lights	All tracks of the current (or specified) disc.
MAG RND	Flashes	All tracks of all discs inserted in the magazine.
OFF	Goes off	Canceled.

To play back tracks repeatedly (Track Repeat/Disc Repeat Play)

You can play back a track or a disc repeatedly.



Each time you press the button, the repeat play mode changes as follows:

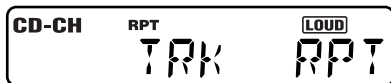
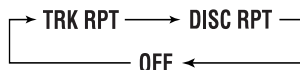

Ex.: When you select "TRK RPT"

Note:

MP3 indicator also lights up if the current playing disc is an MP3 disc.

Mode	RPT Indicator	Plays repeatedly
TRK RPT	Lights	The current (or specified) track.
DISC RPT	Flashes	All tracks of the current (or specified) disc.
OFF	Goes off	Canceled.



Handling cassettes

The cassette deck built in this unit requires very little attention, but you will be able to extend the life of the cassette deck if you follow the instructions below.

To clean the heads

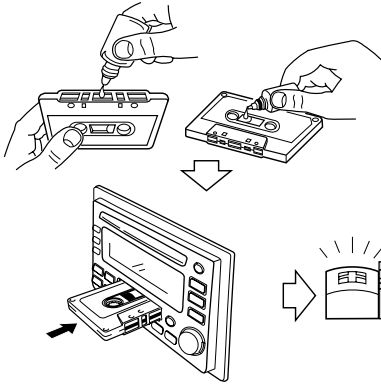

- Clean the heads after every 10 hours of use using a wet-type head cleaning tape (available at an audio store).
When the head becomes dirty, you may realize the following symptoms:
 - Sound quality is reduced.
 - Sound level decreases.
 - Sound drops out.
- Do not play dirty or dusty tapes.
- Do not touch the highly-polished head with any metallic or magnetic tools.

To keep the tape clean

- Always store the tapes in their storage cases after use.
- Do not store tapes in the following places:
 - Subject to direct sunlight
 - With high humidity
 - At extremely hot temperatures

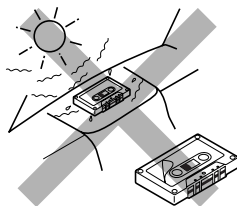

CAUTIONS:

- Do not play the tapes with peeling labels; otherwise, they can damage the unit.
- Tighten tapes to remove slack since loose tape may become entangled with the mechanism.
- Do not leave a cassette in the cassette compartment after use, as the tape may become slack.
- The use of C-120 or longer tape is not recommended, since characteristic deterioration may occur and this tape easily jams in the pinch rollers and the capstans.

The function below is also provided to ensure the longer life of the cassette deck.

Ignition key-off release

When you turn off the ignition key with a cassette in the compartment, the unit automatically releases the tape from its head.



Handling discs

This unit has been designed to reproduce CDs, CD-Rs (Recordable), and CD-RWs (Rewritable).

- **This unit is not compatible with MP3 discs,** but can operate a JVC MP3-compatible CD changer.

How to handle discs

When removing a disc from its case,

press down the center holder of the case and lift the disc out, holding it by the edges.

- Always hold the disc by the edges. Do not touch its recording surface.

When storing a disc into its case, gently insert the disc around the center holder (with the printed surface facing up).

- Make sure to store discs in their cases after use.



To keep discs clean

A dirty disc may not play correctly. If a disc does become dirty, wipe it with a soft cloth in a straight line from center to edge.



To play new discs

New discs may have some rough spots around the inner and outer edges.

If such a disc is used, this unit may reject the disc.

To remove these rough spots, rub the edges with a pencil or ball-point pen, etc.



Moisture condensation

Moisture may condense on the lens inside the CD player in the following cases:

- After starting the heater in the car.
- If it becomes very humid inside the car.

Should this occur, the CD player may malfunction. In this case, eject the disc and leave the unit turned on for a few hours until the moisture evaporates.

When playing a CD-R or CD-RW

Before playing back CD-Rs or CD-RWs, read their instructions or cautions carefully.

- Use only “finalized” CD-Rs or CD-RWs.
- Some CD-Rs or CD-RWs may not play back on this unit because of their disc characteristics, and for the following reasons:
 - Discs are dirty or scratched.
 - Moisture condensation on the lens inside the unit.
 - The pickup lens inside the unit is dirty.
- CD-RWs may require a longer readout time because the reflectance of CD-RWs is lower than that of regular CDs.
- CD-Rs or CD-RWs are susceptible to high temperatures or high humidity, so do not leave them inside your car.
- Do not use following CD-Rs or CD-RWs:
 - Discs with stickers, labels, or protective seal stuck to the surface.
 - Discs on which labels can be directly printed by an ink jet printer.

Using these discs under high temperatures or high humidity may cause malfunctions or damage to discs. For example,

- Stickers or labels may shrink and warp a disc.
- Stickers or labels may peel off so discs cannot be ejected.
- Print on discs may get sticky.

Read instructions or cautions about labels and printable discs carefully.

CAUTIONS:

- Do not insert 8 cm discs (single CDs) into the loading slot. (Such discs cannot be ejected.)
- Do not insert any disc of unusual shape—like a heart or flower; otherwise, the unit will malfunction.
- Do not expose discs to direct sunlight or any heat source or place them in a place subject to high temperature and humidity. Do not leave them in a car.
- Do not use any solvent (for example, conventional record cleaner, spray, thinner, benzene, etc.) to clean discs.

Warped disc



Sticker



Sticker residue

Disc



Stick-on label

TROUBLESHOOTING



What appears to be trouble is not always serious. Check the following points before calling a service center.

Symptoms	Causes	Remedies	
<ul style="list-style-type: none"> • Sound cannot be heard from the speakers. 	The volume control is turned to the minimum level.	Adjust it to the optimum level.	General
<ul style="list-style-type: none"> • This unit does not work at all. 	The built-in microcomputer may have functioned incorrectly due to noise, etc.	Press the reset button on the front panel. (Your preset adjustments will also be erased.) (See page 2.)	
<ul style="list-style-type: none"> • SSM (Strong-station Sequential Memory) automatic preset does not work. 	Signals are too weak.	Store stations manually.	FM/AM
<ul style="list-style-type: none"> • Disc cannot be played back. 	Disc is inserted upside down.	Insert the disc correctly.	Disc playback
<ul style="list-style-type: none"> • Disc sound is sometimes interrupted. 	You are driving on rough roads.	Stop disc play while driving on rough roads.	
	Disc is scratched.	Change the disc.	
	Connections are incorrect.	Check the cords and connections.	
<ul style="list-style-type: none"> • "NO DISC" appears on the display. 	No disc is in the loading slot.	Insert a disc into the loading slot.	
	Disc is inserted incorrectly.	Insert the disc correctly.	
<ul style="list-style-type: none"> • Disc can neither be played back nor ejected. 	The CD player may be functioning incorrectly.	While pressing ⏻/I / ATT , press and hold CD ▲ buttons for more than 2 seconds to eject a CD.	
<ul style="list-style-type: none"> • "ERROR" flashes on the display. 	CD loading or CD ejection does not work correctly.		
<ul style="list-style-type: none"> • CD-R/CD-RW cannot be played back. • Tracks on the CD-R/CD-RW cannot be skipped. 	CD-R/CD-RW is not finalized.	<ul style="list-style-type: none"> • Insert a finalized CD-R/CD-RW. • Finalize the CD-R/CD-RW with the component which you used for recording. 	
<ul style="list-style-type: none"> • "NO TAPE" appears on the display. 	No tape is in the cassette compartment.	Insert a tape into the cassette compartment.	Tape playback
<ul style="list-style-type: none"> • A cassette tape cannot be inserted. 	You have tried to insert a cassette in the wrong way.	Insert the cassette with the exposed tape facing right.	
<ul style="list-style-type: none"> • Cassette tapes become hot. 	This is not a malfunction.	_____	
<ul style="list-style-type: none"> • Tape sound is at very low level and sound quality is degraded. 	The tape head is dirty.	Clean it with a head cleaning tape.	



	Symptoms	Causes	Remedies
CD changer (General)	• “NO CD” appears on the display.	No disc is on the disc tray of the magazine.	Place a disc on the disc tray of the magazine.
	• “NO MAG” appears on the display.	No magazine is loaded in the CD changer.	Insert the magazine into the CD changer.
	• “RESET 8” flashes on the display.	This unit is not connected to a CD changer correctly.	Connect this unit and the CD changer correctly and press the reset button of the CD changer.
	• “RESET 1” – “RESET 7” flashes on the display.	_____	Press the reset button of the CD changer.
	• The CD changer does not work at all.	The built-in microcomputer may function incorrectly due to noise, etc.	Press the reset button on the front panel. (Your preset adjustments will also be erased.) (See page 2.)
CD changer (MP3 discs)	• Disc cannot be played back.	No MP3 tracks are recorded on the disc.	Change the disc.
		MP3 tracks do not have the extension code—<.mp3> in their file names.	Add the extension code—<.mp3> to their file names.
		MP3 tracks are not recorded in the format compliant with ISO 9660 Level 1 or 2.	Change the disc. (Record MP3 tracks using a compliant application.)
	• Noise is generated.	The track played back is not an MP3 file (although it has the extension code—<.mp3>).	Skip to another track or change the disc. (Do not add the extension code—<.mp3> to non-MP3 files.)
	• A longer readout time is required.	Readout time varies due to the complexity of the folder/track configuration.	It is not recommended to use too many hierarchies and folders, and to record any other types of audio tracks together with MP3 tracks.
• Tracks cannot be played back as you have intended them to play.	Playback order is determined when the tracks are recorded.	Insert a disc that contains tracks encoded in an appropriate format.	

About mistracking:

Mistracking may result from driving on extremely rough roads. This does not damage the unit and the CD, but will be annoying. We recommend that you stop CD play while driving on such rough roads.

AUDIO AMPLIFIER SECTION

Maximum Power Output (DC 16V):

Front: 50 W per channel

Rear: 50 W per channel

Continuous Power Output (10% THD):

Front: 25 W per channel into 4 Ω .

Rear: 25 W per channel into 4 Ω .

Load Impedance: 4 Ω (4 to 8 Ω allowance)

TUNER SECTION

Frequency Range:

FM: 87.5 MHz to 108.0 MHz

AM: 531 kHz to 1 602 kHz

[FM Tuner]

Usable Sensitivity: 6 dB μ V

Stereo Separation: 28 dB

[AM Tuner]

Sensitivity: 30 dB μ V

CD PLAYER SECTION

Type: Compact disc player

Signal Detection System: Non-contact optical pickup (semiconductor laser)

Number of channels: 2 channels (stereo)

Frequency Response: 30 Hz to 20 000 Hz

Signal-to-Noise Ratio: 75 dB

Wow and Flutter: Less than measurable limit

Channel Separation (1 kHz): 65 dB

CASSETTE DECK SECTION

Frequency Response: 30 Hz to 16 000 Hz

Wow and Flutter: 0.2 % (WRMS)

GENERAL

Power Requirement:

Operating Voltage: DC 14.4 V

(11 V to 16 V allowance)

Grounding System: Negative ground

Dimensions (W x H x D):

Installation Size:

178 mm x 100 mm x 175 mm

Front Panel Size:

183 mm x 103 mm x 15 mm

Mass: 2.2 kg (excluding accessories)

Design and specifications are subject to change without notice.



**Having TROUBLE with operation?
Please reset your unit**

Refer to page of How to reset your unit

**Punya MASALAH pengoperasian ?
Tolong reset unit anda**

Lihat pada halaman tentang mereset unit