

Operating and Installation Instructions

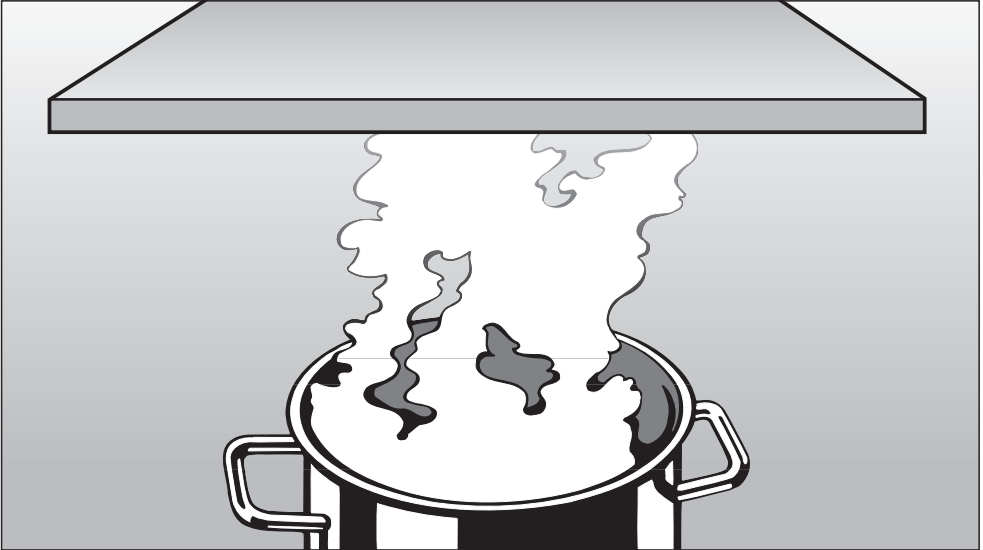

Ventilation System DA 250-4

To prevent accidents
and machine damage,
read these instructions

before

installation or use.



M.-Nr. 06 850 870

Contents

IMPORTANT SAFETY INSTRUCTIONS	3
Functional description	7
Guide to the hood	8
Operation	10
Turning on the fan	10
Selecting the power level.	10
Delayed Shut Down	12
Turning off the fan	12
Turning the lighting on/off	13
Dimming the lighting	13
Grease filter timer.	14
Cleaning and care	16
Cleaning the casing	16
Grease filter	17
Changing the light bulb	19
After Sales Service	20
Installation instructions	21
Caring for the environment	23
Structural support	24
Electrical data	25
Appliance dimensions	26
Installation	27
Installation instructions	28
Installation accessories	28
Air extraction	29

IMPORTANT SAFETY INSTRUCTIONS

Read these Operating Instructions carefully before installing or using the Ventilation System.

This appliance is intended for residential use only. Use the appliance only for its intended purpose. The manufacturer cannot be held responsible for damages caused by improper use of the hood.

This appliance complies with current safety requirements. Improper use of the appliance can lead to personal injury and material damage.

READ AND SAVE THESE INSTRUCTIONS

CAUTION

Use only for general ventilation. Do not use to exhaust hazardous or explosive materials and vapors.

■ This appliance is designed to vent cooking smoke and odors only.

■ Be certain your appliance is properly installed and grounded by a qualified technician.

To guarantee the electrical safety of this appliance, continuity must exist between the appliance and an effective grounding system. It is imperative that this basic safety requirement be met. If there is any doubt, have the electrical system of the house checked by a qualified electrician. The manufacturer cannot be held responsible for damages caused by the lack, or inadequacy, of an effective grounding system.

■ Before connecting the appliance to the power supply make sure that the voltage and frequency listed on the data plate correspond with the household electrical supply. This data must correspond to prevent machine damage. If in doubt consult a qualified electrician.

■ Installation work and repairs should only be performed by a qualified technician in accordance with all applicable codes and standards. Repairs and other work by unqualified persons could be dangerous and the manufacturer will not be held responsible.

IMPORTANT SAFETY INSTRUCTIONS

■ This equipment is not designed for maritime use or for use in mobile installations such as recreational vehicles or aircraft. However, under certain conditions it may be possible for an installation in these applications. Please contact the nearest Miele dealer or the Miele Technical Service Department with specific requirements.

■ Before servicing or cleaning the unit, switch power off at the service panel and lock the service disconnecting means to prevent power from being switched on accidentally. If the service disconnecting means cannot be locked, securely fasten a prominent warning device, such as a tag, to the service panel.

■ Before discarding an old appliance, disconnect it from the power supply and remove the power cord to prevent hazards.

Use

■ Do not allow children to play with or operate the appliance or its controls. Supervise its use by the elderly or infirm.

■ Do not flambé or grill with an open flame beneath the hood. Flames could be drawn up into the hood by the suction and the grease filters may catch fire.

■ Never operate gas burners without cookware. Turn the burner off when not in use. Adjust the burner so that the flames do not extend beneath the cookware. Do not overheat the cookware, e.g. when using a wok. The hood can be damaged due to excessive heat from the burners and the cookware.

■ Do not use the hood without the grease filter in place.





■ Clean the grease filter regularly. Dirty filters are a fire hazard.

■ Do not use a steam cleaner to clean the hood. Steam could penetrate electrical components and cause a short circuit.





■ Always turn on the hood when using the cooktop to prevent damage from condensation.

IMPORTANT SAFETY INSTRUCTIONS

WARNING - TO REDUCE THE RISK OF A COOKTOP GREASE FIRE:

-  Never leave surface units unattended at high settings. Boilovers cause smoking and greasy spillovers may ignite. Heat oils slowly on low or medium settings.
-  Always turn the hood on when cooking at high heat.
-  Clean ventilating fans frequently. Grease should not be allowed to accumulate on fan or filter.
-  Use proper pan size. Always use cookware appropriate for the size of the surface element.

WARNING TO REDUCE THE RISK OF INJURY TO PERSONS, IN THE EVENT OF A COOKTOP GREASE FIRE, OBSERVE THE FOLLOWING:

-  **SMOTHER FLAMES** with a close fitting lid, cookie sheet, or metal tray then turn off the burner. **BE CAREFUL TO PREVENT BURNS.** If the flames do not go out immediately, **EVACUATE AND CALL THE FIRE DEPARTMENT.**
-  **NEVER PICK UP A FLAMING PAN** - You may be burned.
-  **DO NOT USE WATER**, including wet dishcloths or towels - a violent steam explosion will result.
-  Use a fire extinguisher **ONLY** if:
 - You have a class ABC extinguisher, and you know how to operate it.
 - The fire is small and contained in the area where it started.
 - The fire department is being called.
 - You can fight the fire with your back to an exit.

IMPORTANT SAFETY INSTRUCTIONS

Installation

 **WARNING**
To reduce the risk of fire only use metal ductwork.

 Any fittings, sealant, or materials used to install the ductwork must be made of approved non-flammable materials.

 Provided a larger distance is not given by the manufacturer of the cooktop, follow the minimum safety distances between a cooktop and the bottom of the hood:

- 22" (550 mm) above electric cooktops,
- 30" (762 mm) above gas cooktops,
- 26" (650 mm) above an open electric grill or an open electric boiler/fryer.

If local building codes require a greater safety distance, follow their requirement.

If there is more than one appliance beneath the hood and they have different minimum safety distances always select the greater distance.

 Do not install this hood over cooktops burning solid fuel.

 Be careful not to damage hidden electrical wiring or plumbing when cutting or drilling into the wall or ceiling.

 Do not use an extension cord to connect the appliance to electricity. Extension cords do not guarantee the required safety of the appliance, (e.g. danger of overheating).

 Never connect an exhaust hood to an active chimney, dryer vent, vent flue, or room ventilating ductwork. Seek professional advice before connecting an exhaust hood vent to an existing, inactive chimney or vent flue.

 Ducted fans must always be vented outdoors.

 Make sure that the airflow in the room is sufficient for combustion and exhausting of all non-electric heating appliances (water heaters, gas cooktops, gas ovens, etc.), otherwise backdrafts may occur. Follow the heating manufacturer's guidelines and safety standards or those published by the National Fire Protection Association (NFPA) or the American Society for Heating, Refrigeration and Air Conditioning Engineers (ASHRAE). If in doubt, consult an experienced professional.

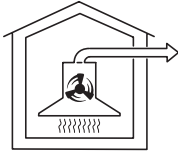

The ventilation hood works by **air extraction**. The air is drawn in and cleaned by the grease filter and directed outside.

The hood comes equipped with a **non-return flap**. This flap automatically closes when the hood is turned off so that no exchange of outside air and room air can occur. When the hood is turned on, the air pressure of the exhaust fan automatically opens the flap blowing the inside air and cooking odors outside.

Guide to the hood

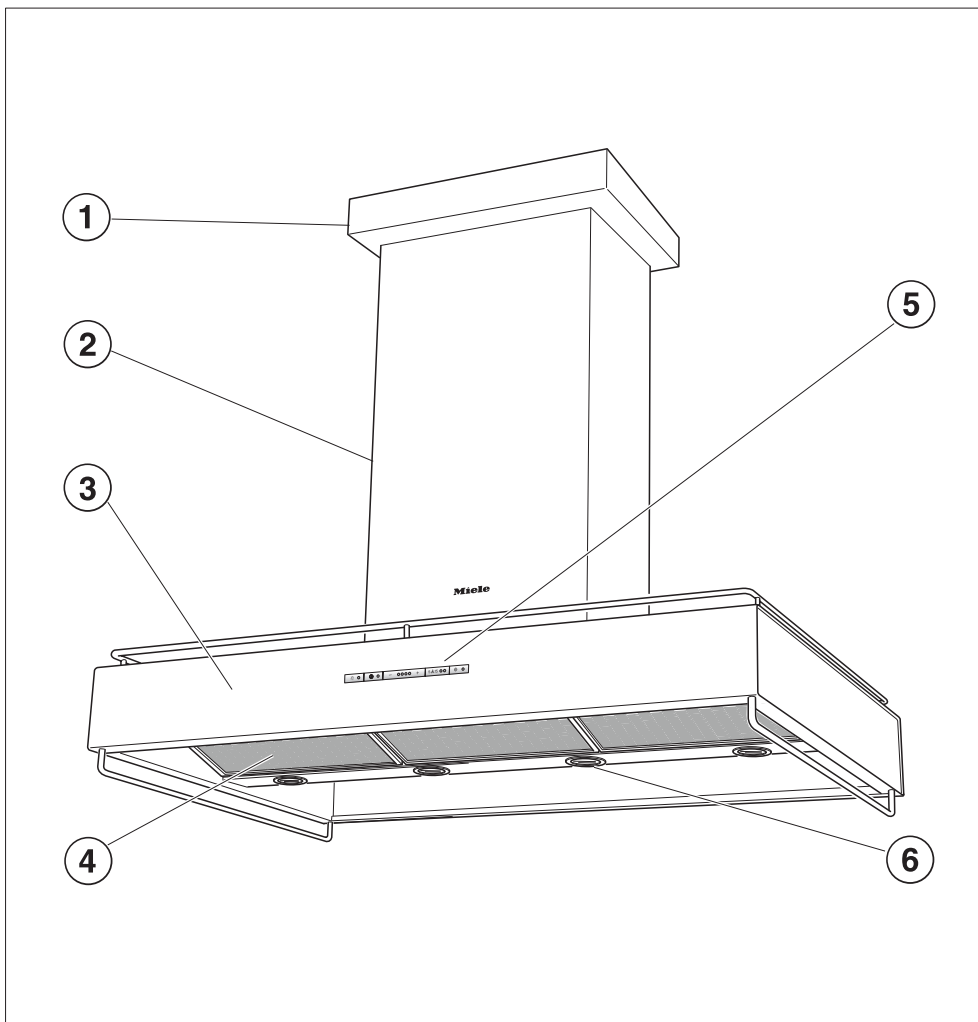

daa20155

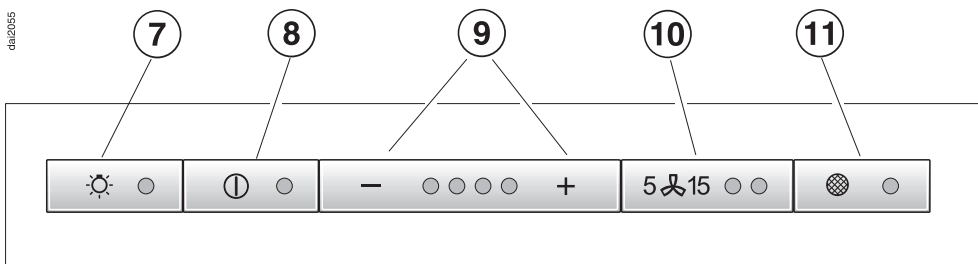

① Cover frame

② Chimney

③ Canopy

④ Grease filter

⑤ Control panel

⑥ Overhead lighting

⑦ Light button

This button turns the light on and off and also dims the light.

The lighting can be used independently of the fan.

⑧ On/Off button

⑨ Fan power level buttons

Four fan speed selection.

⑩ Delayed Shut Down

This button activates the Delayed Shut Down feature. The fan can be set to turn off automatically after either 5 or 15 minutes.

⑪ Grease filter button

The indicator next to the grease filter button lights when the grease filter needs to be cleaned.

This button is also used:

- to reset the grease filter timer after cleaning the grease filter (see "Cleaning and Care").
- to show how long the grease filter has been in use (see "Operation / Grease filter timer").
- to change the number of hours counted by the grease filter timer (see "Operation / Reprogramming the grease filter timer").

Operation

Turning on the fan



- Press the On/Off button.

The hood turns on on level 2 and the indicator lights.

Selecting the power level



- Use the "-/+ " controls to select the desired power level.

+ = increases the fan speed
- = decreases the fan speed

Levels "1" to "3" (green indicators) are usually sufficient for normal cooking.

Intensive setting

Level "4" (yellow indicator) should be used for a short period when frying or cooking food with a strong aroma.

Automatically switching back the intensive power level

The intensive level "4" can be programmed to automatically switch back to level "3" after 10 minutes.

- Turn the fan and the lights off.



- Press and hold the "Delay Shut down" button for 10 secs. The first indicator lights.
- Press the following buttons one after another,



- light



- the "-" button, and



- the light button again.



If the power level indicators "1" and "4" flash, the automatic switch back is not activated.

- To activate the automatic switch back press the "+" button.

The power level indicators "1" and "4" light continuously.

- To deactivate press the "-" button.



- To save the setting press the "Delay Shut Down" button.

If the procedure is not stored within 4 minutes of programming, the hood will automatically default to the "old" data.

Fan performance

The maximum air flow capacity is 625 cfm. Factors such as narrow duct diameter and bends will affect this value.

Level 1 operates at 40% capacity

Level 2 operates at 60% capacity

Level 3 operates at 80% capacity

Level 4 operates at 100% capacity

Operation

Delayed Shut Down

If odors or smoke remain in the kitchen after cooking has been completed, the Delayed Shut Down feature can be selected to allow the hood to continue running for either 5 or 15 minutes. After that period of time the fan turns off automatically.



- Press the Delayed Shut Down button while the fan is still running.

Press once = 5 minute delay
(left indicator lights)

Press twice = 15 minute delay
(right indicator lights)

To cancel the feature press the Delayed Shut Down button again. The fan will not turn off automatically.

Turning off the fan



- Press the On/Off button to turn the fan off.

The indicator goes out.

Automatic Safety Shut Off

The fan will turn off automatically 10 hours after the last button was activated. The lighting however will remain on.

- Press the On/Off button to turn the fan back on again.

Turning the lighting on/off

The overhead lighting can be turned on and off independently of the fan.



- Press the light button **briefly** to turn on the lighting.

The light button indicator illuminates.

- Press the light button **briefly** again to turn off the lighting.

The light button indicator will go out.

Dimming the lighting

The brightness of the lighting can be adjusted.

- While the lighting is turned on, press and hold the light button. The lighting will dim until the button is released.

- If the button is pressed again, the lighting will brighten until the button is released.

If the button is pressed continuously, the light will cycle between bright and dark.

- Press the light button again to turn off the lighting.

Operation

Grease filter timer

A timer monitors the hours of fan operation. The indicator for the grease filter will light after 30 hours of operation or the preselected time. The **grease filter** must then be cleaned. See "Cleaning and care / Grease Filter".

After the grease filter has been cleaned and put back in place, the grease filter timer must be reset.



- To do this, press the grease filter button for about 3 seconds while the fan is running.

The indicator will go out.

Checking the grease filter timer

To check the percentage of time already used:



- Press the On/Off button to turn the fan on.



- Press the grease filter button.

The indicator lights.



The number of flashing "-/+ " indicators show the percentage of programmed hours that have been used.

- 1 indicator = 25 %
- 2 indicators = 50 %
- 3 indicators = 75 %
- 4 indicators = 100 %

This information will remain stored in memory in the event of a power failure.

Reprogramming the grease filter timer

The grease filter timer is preset to 30 hours. This time can be lengthened or shortened to 20, 30, 40 or 50 hours.

- A time of 20 hours should be programmed in kitchens with frequent pan or deep frying.
- A time of 20 hours should also be programmed if the kitchen is only used occasionally to prevent grease which has accumulated over a long period of time from hardening on the filter, making cleaning more difficult.



- Press the On/Off button to turn off the fan.



- Press the Delayed Shut Down and grease filter button at the same time.

The indicator for the grease filter timer and one of the "-/+ " indicators will flash.



The lit "-/+ " indicator shows the programmed time:

- 1st indicator from the left = 20 hours
- 2nd indicator from the left = 30 hours
- 3rd indicator from the left = 40 hours
- 4th indicator from the left = 50 hours

- Use the "-/+ " button to select the desired time.



- Store the selection by pressing the grease filter button.

If the procedure is not stored within 4 minutes of programming the hood will automatically default to the "old" data.

Cleaning and care

Before cleaning or servicing the hood, disconnect it from the power supply by either removing the fuse, unplugging it from the outlet or manually "tripping" the circuit breaker.

Cleaning the casing

 Never use on the hood:

- cleaning agents containing soda, acids, chlorides or thinners,
- abrasive cleaning agents e.g. powder or cream cleansers,
- steel wool or abrasive sponges, e.g. pot scourers or sponges which have been previously used with abrasive cleaning agents,
- limescale removers,
- caustic (oven) cleaners.

They will damage the surface.

- The exterior surfaces and controls can be cleaned with warm water and liquid dish soap applied with a soft sponge.
- Wipe dry using a soft cloth.

Only use a slightly damp sponge when cleaning the controls. Water could penetrate into the electronics and cause damage.

- Glass surfaces can be cleaned using glass cleaner.

Stainless steel

Stainless steel surfaces can be cleaned using a non-abrasive stainless steel cleaner.

To help prevent resoiling, a conditioner for stainless steel can also be used. Apply sparingly with even pressure.

Stainless steel colored controls

These controls may become discolored or damaged if not cleaned regularly. Do not use a stainless steel cleaner on these controls.

Grease filter

The reusable metal grease filter removes solid particles from the vented kitchen air (grease, dust, etc).



The grease filter should be cleaned every 3 - 4 weeks or whenever the grease filter indicator lights.

Keep the grease filter clean to prevent a fire hazard.

Removing the grease filter

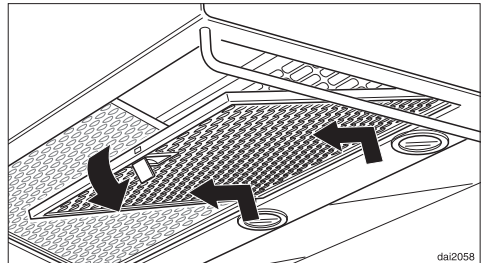

- To remove the grease filter pull the locking clip forward. Lower the filter 45° unhook it at the rear and take it out. Support the grease filter so that it does not fall onto the cooktop.

Cleaning and care

Cleaning the grease filter

- **By hand:** use a scrub brush with a solution of warm water and mild detergent.

Do not use the pure detergent, aggressive all purpose cleaners, oven sprays, abrasive cleaning agents or limescale removers. They could destroy the filter.

- **In a dishwasher:** place the filter vertically in the lower basket, making sure that the spray arm is not blocked.

Use a hot temperature program, e.g. "Heavy Soil" or "Pots and pans". Use the recommended amount of dishwasher detergent. Overuse could destroy the filter.

Depending on the detergent, cleaning the grease filter in a dishwasher may cause permanent discoloration of the filter surface. Performance of the filter will not be affected by this discoloration.

- After cleaning, the filter can be placed on a towel to air dry.
- While the filter is removed, clean any dirt or grease from the interior casing to prevent the risk of fire.
- When putting the grease filter back make sure that the locking clip is facing the cooking surface.

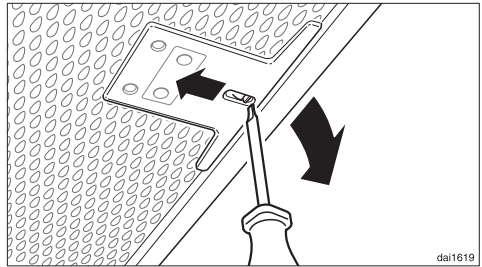

- If the filter is incorrectly installed, insert a small screwdriver into the slit along its edge to disengage it from the casing.



- After returning the grease filter, press the grease filter button for 3 seconds to reset the timer. The indicator light will go out.
- If the grease filter is cleaned **before** the grease filter timer has reached its maximum, the grease filter button should be pressed for 6 seconds to reset the counter to zero.

Changing the light bulb

Before changing the light bulbs, disconnect the hood from the power supply by either removing the fuse, unplugging it, or manually "tripping" the circuit breaker.

When in use halogen bulbs become extremely hot, and can burn your hands. Do not attempt to change the bulbs until they have had sufficient time to cool.

Do not touch the bulb surface. Fingerprints or body oils deposited on the bulb will decrease its life. Please follow the manufacturer's instructions.

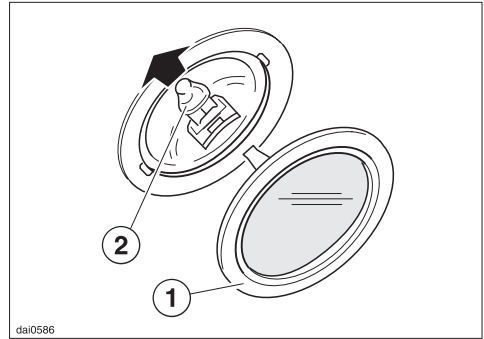

- To change the halogen bulb first pull off the lamp cover, ①.
- Pull the bulb, ②, out of its socket and replace it with a new one.
- Return the lamp cover, ①, making sure it clicks into place.

Never use the lighting without the lamp cover, ①, in place. The glass is specially made to filter harmful light rays.

After Sales Service

Repairs

In the event of a fault which you cannot easily fix yourself, please contact the Miele Technical Service Department at the phone number on the back of this booklet.

- When contacting the Technical Service Department, please quote the model and serial number of your appliance.

These are shown on the data plate which is visible when the grease filter is removed.

MieleCare

(only USA)

MieleCare, our Extended Service Contract program, gives you the assurance of knowing that your appliance investment is covered by 5 years of worry free ownership.

MieleCare is the only Extended Service Contract in the industry that guarantees repairs by a Miele Authorized Service Provider using genuine Miele parts. Only genuine Miele parts installed by factory trained professionals can guarantee the safety, reliability, and longevity of your Miele appliance.

Please note that unless expressly approved in writing by Miele's Service department, Extended Service Contracts offered by other providers for Miele products will not be recognized by Miele. Our goal is to prevent unauthorized (and untrained) service personnel from working on your Miele products, possibly doing further damage to them, you and/or your home.

To learn more about **MieleCare** Extended Service Contracts, please contact your appliance dealer or visit us online at:

www.store.miele.com

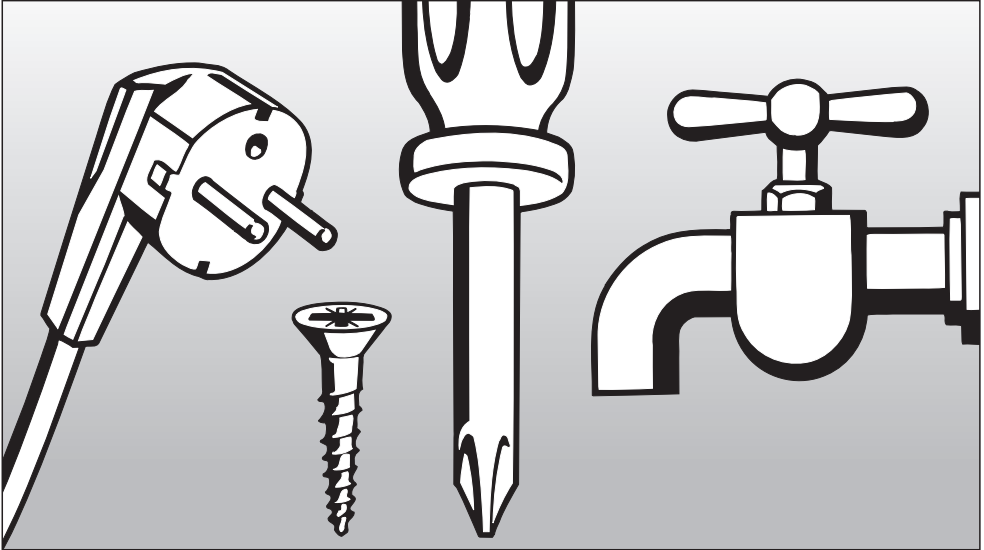

Installation Instructions

Disposal of packing material

The cardboard box and packing materials protect the appliance during shipping. They have been designed to be biodegradable and recyclable. Please recycle.

To prevent suffocation of children, ensure that any plastic wrappings, bags, etc. are disposed of safely and kept out of their reach.

Disposal of an old appliance

Old appliances may contain materials that can be recycled. Please contact your local recycling center about the possibility of recycling these materials.

Before discarding an old hood, unplug it from the outlet and cut off its power cord to prevent hazards.

Structural support

The ceiling mounting plate will support the weight of the hood. This ceiling plate must be attached to rigid structural framing that is supported in its entirety by the ceiling joists, or to the ceiling joists directly. Do not attach the plate directly to the ceiling with anchors, toggle bolts, etc.

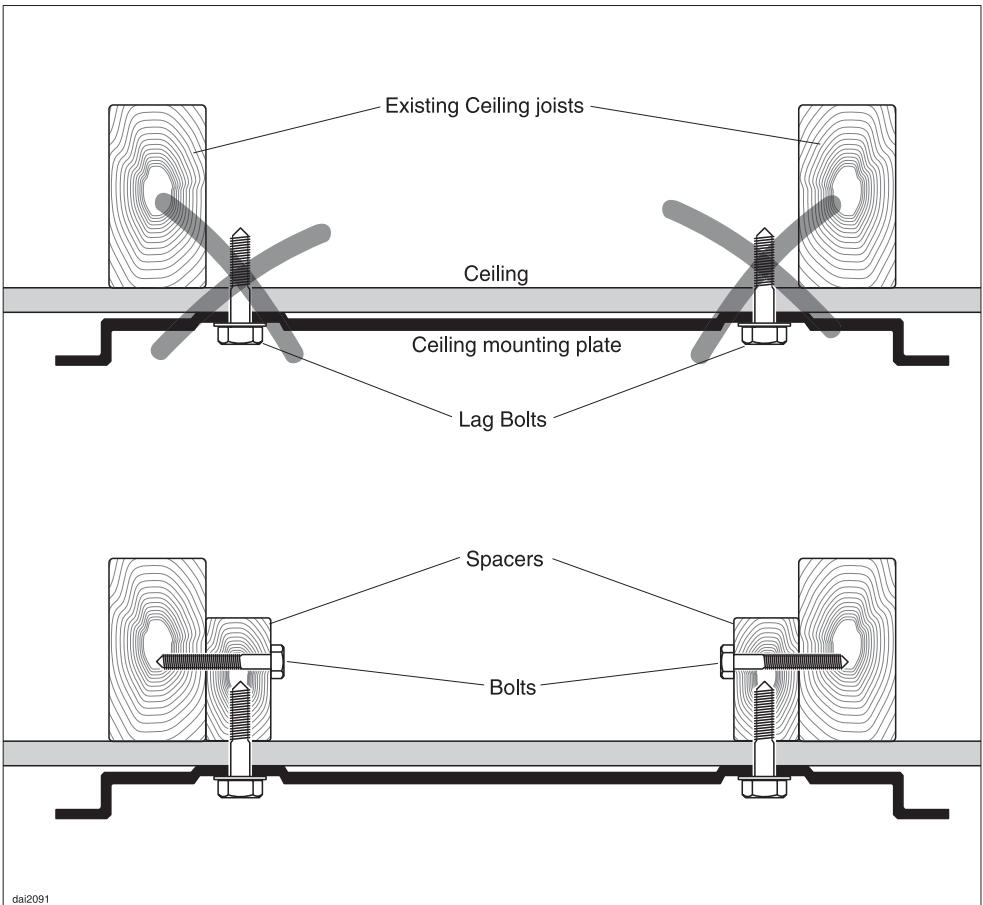

dai2091

All electrical work should be performed by a qualified electrician in strict accordance with national and local safety regulations.

Installation, repairs and other work by unqualified persons could be dangerous. The manufacturer can not be held responsible for unauthorized work.

Ensure that power to the appliance is OFF while installation or repair work is performed.

Verify that the voltage, load and circuit rating information found on the data plate (located behind the grease filter), match the household electrical supply before installing the hood.

If there is any question concerning the electrical connection of this appliance to your power supply, please consult a licensed electrician or call Miele's Technical Service Department. See back cover for contact information.

WARNING: THIS APPLIANCE MUST BE GROUNDED

Important

To increase security before the machine is installed, it is recommended to install a protective switch (30 mA).

Important

The hood must be hard wired accordingly:

Black/Red wire: connect to L1 (live)

White wire: connect to N (neutral)

Green wire: . . connect to GND (ground)

Maximum load 430 W

Fan 350 W

Lighting 4 x 20 W

Voltage 120 V

Frequency 60 Hz

Circuit rating 15 A

Appliance dimensions

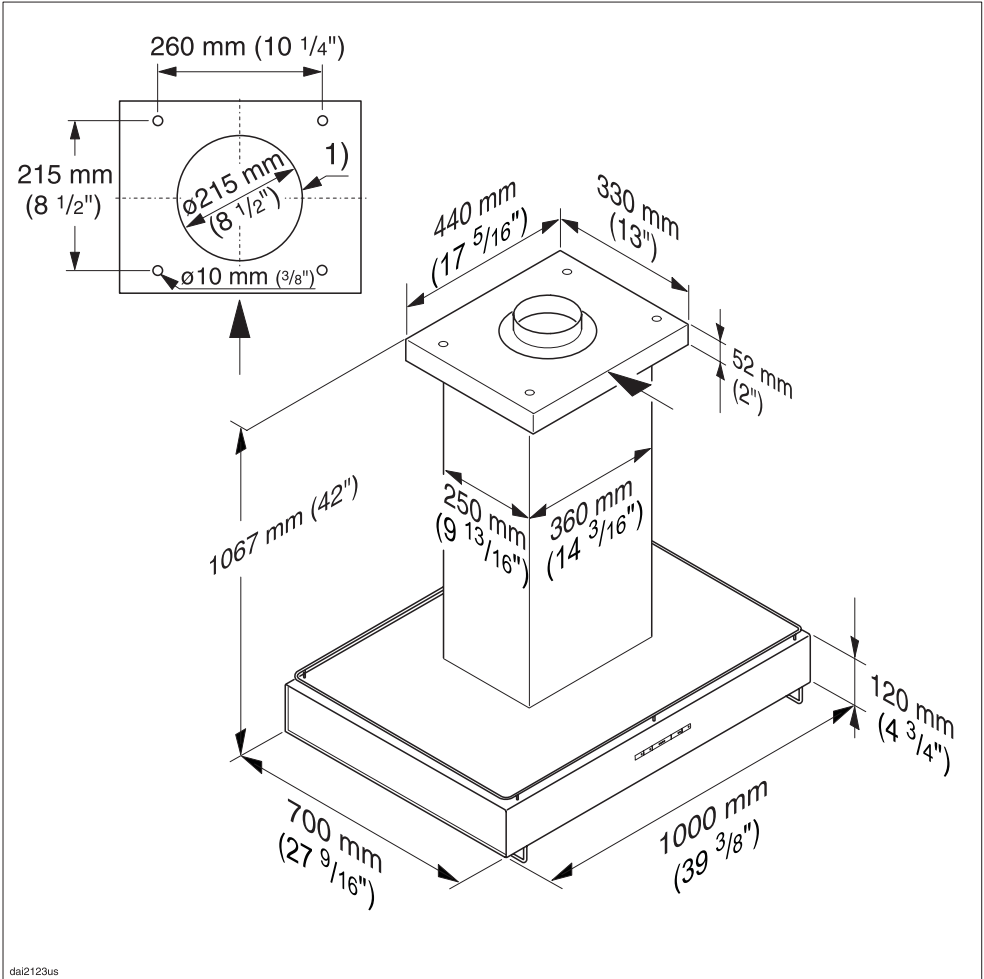

Exhaust connection 6" (150 mm) diameter

1) Entrance for ductwork and power cord

Do not install this exhaust hood over cooktops burning solid fuel.

Provided a larger distance is not given by the manufacturer of the cooktop, follow the minimum safety distances between a cooktop and the bottom of the hood:

- 22" (550 mm) above electric cooktops,
- 30" (762 mm) above gas cooktops,
- 26" (650 mm) above an open electric grill or an open electric boiler/fryer.

If there is more than one appliance beneath the hood and they have different minimum safety distances always select the greater distance.

Observe local building codes.

See "Important Safety Instructions" for further information.

CAUTION:

During the installation process, please be careful of sharp edges that can cause harm.

Installation

Installation instructions

- See the enclosed installation instruction sheet.
- Please read the "Important Safety Instructions" and Installation instructions before installing this hood.

Installation accessories

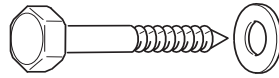

4 Screws 8 x 60 mm with 4 Washers

for securing the ceiling plate.

(S8 wall anchors included in the packaging are not for use in USA)



2 Screws M 4 x 8 mm

for adjusting the chimney.

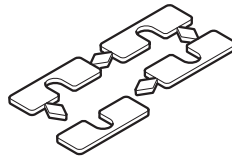

4 leveling plates

for correcting an uneven ceiling.

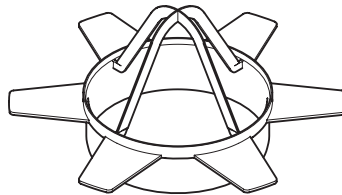

1 exhaust connector

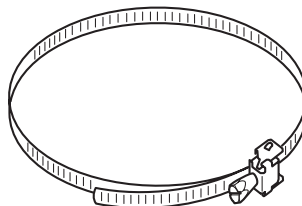

1 hose clip for securing the ducting.

 **WARNING**

Danger of toxic fumes.

Gas cooking appliances release carbon monoxide that can be harmful or fatal if inhaled. The exhaust gases extracted by the hood should be vented outside of the building only.

Do not terminate the exhaust ducts in attics, garages, crawlspaces, etc.

To reduce the risk of fire, only use metal ductwork.

Please read and follow the **"IMPORTANT SAFETY INSTRUCTIONS"** to reduce the risk of personal injury. Follow all local building codes when installing the hood.

Exhaust ducting and connections

- The ducting should be as short and straight as possible, and the number of sharp bends should be minimized.
- For most efficient air extraction, the diameter of the ductwork should not be less than 6" (150 mm). Use of flat ducts also reduces the air extraction efficiency.
- Noise levels of the hood will increase if flat ducts or round ducts of less than 6" (150 mm) in diameter are used.
- Use smooth or flexible pipes made from approved non-flammable materials for exhaust ducting.
- Where the ductwork is horizontal, it must slope away from the hood at least $\frac{1}{8}$ " per foot (1 cm per meter) to prevent condensation dripping into the appliance.
- If the exhaust is ducted through an outside wall, a Miele Telescopic Wall Vent can be used.

Air extraction

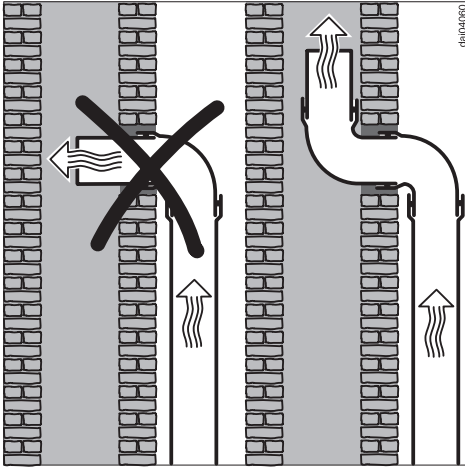

- If the exhaust is ducted into an inactive flue, the air must be expelled parallel to the flow direction of the flue.

Never connect an exhaust hood to an active chimney, dryer vent, flue, or room venting ductwork. Seek professional advice before connecting an exhaust hood vent to an existing, inactive chimney or vent flue.

Important

If the ductwork runs through rooms, ceilings, garages, etc. where temperature variations exist, it may need to be insulated to reduce condensation.

Condensate trap

optional accessory

In some cases, a condensate trap may be required to collect and evaporate any condensation which may develop. This optional accessory is available for ducts 5" (125 mm) and 5 7/8" (150 mm) in diameter.

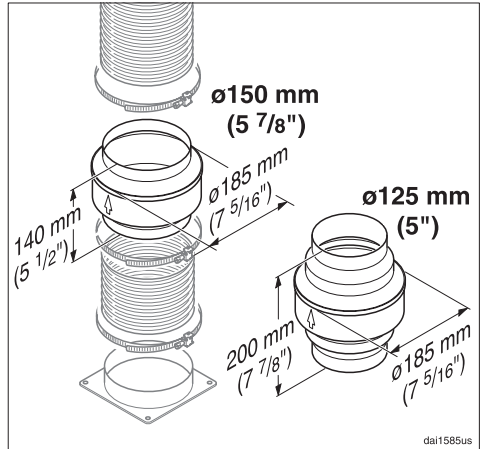

- When installing a condensate trap, ensure that it is positioned vertically and if possible directly above the exhaust outlet.

When contacting the Technical Service,
please quote the model and serial number
of your appliance.



Miele, Inc. (USA)

National Headquarters

9 Independence Way
Princeton, NJ 08540
Phone: 800-843-7231
609-419-9898
Fax: 609-419-4298
www.miele.com

**Technical Service & Support
Nationwide**

Phone: 800-999-1360
Fax: 888-586-8056

Miele Limited (CDN)

Headquarters and Showroom

161 Four Valley Drive
Vaughan, ON L4K 4V8
Phone: 800-643-5381
905-660-9936
Fax: 905-532-2290
www.miele.ca
info@miele.ca (general enquiries)
professional@miele.ca (commercial enquiries)

MieleCare National Service

Phone: 800-565-6435
905-532-2272
Fax: 905-532-2292
service@miele.ca (technical enquiries)