

OWNER'S MANUAL

C3-570

5-inch x 7-inch (125 x 180 mm) Convertible 2-Way Component System



Thank you for choosing a JL Audio Evolution™ C3 Convertible Component System for your automotive sound system.

These Evolution™ Speakers have been designed and manufactured to exacting standards in order to ensure years of musical enjoyment in your vehicle. For maximum performance and extended warranty coverage, we highly recommend that you have your new speakers installed by an authorized JL Audio dealer. Your authorized dealer has the training, expertise and installation equipment to ensure optimum performance from this product. Should you decide to install the speakers yourself, please take the time to read this manual thoroughly so as to familiarize yourself with its installation requirements and setup procedures.

If you have any questions regarding the instructions in this manual or any aspect of your amplifier's operation, please contact your authorized JL Audio dealer for assistance. If you need further assistance, please call the JL Audio Technical Support Department at (954) 443-1100 during business hours.



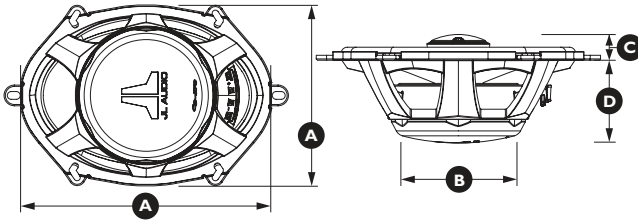

Woofer Physical Dimensions

Frame Outer Diameter (A)	5.52 x 7.68 in. / 140.2 x 195.1 mm
Rear Cover Outer Diameter (B)	4.08 in. / 103.6 mm
Frontal Tweeter Protrusion (C)	0.78 in. / 19.8 mm
Mounting Depth (D)	2.52 in. / 64.0 mm

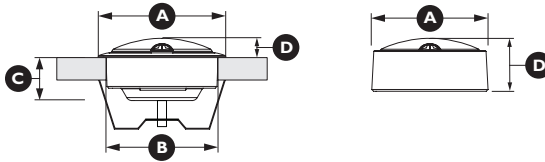

Tweeter Fixture Physical Dimensions

Flush-Mount

Surface-Mount

Fixture Outer Diameter (A)	2.12 in. / 53.8 mm	1.93 in. / 49.0 mm
Fixture Mounting Hole Diameter (B)	1.875 in. / 47.6 mm	N/A
Fixture Mounting Depth (C)	0.71 in. / 18.0 mm	N/A
Tweeter Frontal Protrusion (D)	0.32 in. / 8.1 mm	0.95 in. / 24.1 mm

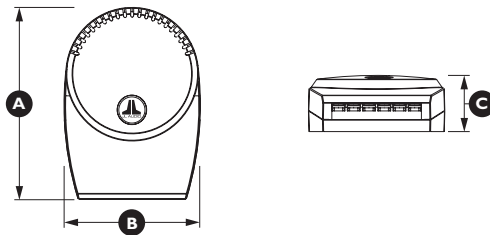

Crossover Network Physical Dimensions

Height (A)	4.72 in. / 119.9 mm
Width (B)	3.36 in. / 85.3 mm
Depth (C)	1.44 in. / 36.6 mm

C3-570 SPECIFICATIONS

Woofers: Injection-Molded Polymer Frame, Patented Elevated Frame Cooling (U.S. Patent #6,219,431 & #6,229,902), DMA-Optimized Motor System, Mineral-Filled Polypropylene Cone, Rubber Surround, 1.2-in. / 31 mm Voice Coil, Kapton® Former, Low-Profile, Symmetrical Roll Spider, Ferrite Magnet

Tweeters: 1.00 in. / 25 mm Silk Soft Dome with Ferrofluid Cooling and Damping and Neodymium Magnet
Fixed Angle Flush-Mount, Surface-Mount and Coaxial-Mount Systems

Crossover Networks: 2-way networks with 1st order low-pass and 2nd order high-pass filters, premium Mylar® capacitors, air-core inductors, 4-position adjustable tweeter output level, 3-position midrange presence control, Polyswitch tweeter protection

Continuous Power Handling: 75 Watts (RMS Method)

Frequency Response: 48 Hz - 25 KHz (± 3 dB)

Efficiency @ 1W/1m: 90.0 dB @ 1W/1m

Nominal Impedance: 4 ohms

Included Components and Parts:

- Two C3-570cw 5x7-inch (125 x 180 mm) Woofers
- Two C3-100ct 1.00-inch (25 mm) Tweeters
- Two C3-570-XO Crossover Networks
- Two Surface-Mount Tweeter Fixtures
- Two Coaxial-Mount Tweeter Fixtures
- Two Flush-Mount Tweeter Fixtures
- Two Metal Spring Clips for Tweeter Fixtures
- Two Woofer Spacer Gaskets
- Twelve #8 x 1.25 inch (32 mm) Sheet Metal Screws
- Four #6 x 1.00-inch (25 mm) Sheet Metal Screws
- Two 1.00-inch (25 mm) Machine Screws
- Eight Mounting Clips for Woofer Mounting
- Two 6.4 mm Female Crimpable Connectors
- Two 4.7 mm Male Crimpable Connectors
- Two 4.7 mm Female Crimpable Connectors
- Four 2.8 mm Female Crimpable Connectors
- Two 2.8 mm Male Crimpable Connectors
- Twelve Crimpable Spade Connectors
- One Woofer Mounting Template

GETTING STARTED

- Turn off the audio system. It is also advisable to disconnect the negative (-) terminal of your vehicle's battery whenever performing installation work.
- Before cutting, drilling or inserting any screw, check clearances on both sides of the planned mounting surface. Also check for any potential obstacles, such as window tracks and motors, wiring harnesses, etc. Check both sides of the vehicle, many vehicles are not symmetrical!
- Always wear protective eyewear.

CROSSOVER NETWORK INSTALLATION

The crossover networks supplied with your C3 System should be installed in a dry location inside your vehicle. **DO NOT INSTALL THEM INSIDE OF A DOOR!** Doors often get wet on the inside, which can damage your crossover networks and could potentially damage your entire sound system. The crossovers can be screwed into a solid surface via two holes located under the protective cover of the case. To access these holes, simply squeeze the sides of the cover while gently pulling the cover away from the base. Make sure that your mounting location will not cause damage to wiring, fuel lines, brake lines or any other vital component of your vehicle. Once you have screwed the case in and made your connections, snap the protective cover back into place.

TWEETER PROTECTION

The C3 crossover networks are equipped with an advanced electronic tweeter protection circuit designed to minimize the possibility of tweeter failure. This electronic device monitors current going to the tweeter and will disconnect the tweeter from the signal when it senses overload. Should this occur while listening to the audio system, simply reduce the volume for a few seconds and the protection circuit will reset itself automatically.

CROSSOVER NETWORK ADJUSTMENT

The crossover networks have been designed to allow tonal adjustments to the upper midrange response and tweeter level. These adjustments make it possible to fine-tune your system to suit your listening preferences and to compensate for various speaker mounting applications.

ADJUSTABLE MIDRANGE PRESENCE

Your C3 crossover networks provide a unique midrange presence control, located under the cover. The midrange presence is selectable via a set of pins and allows for three settings. These settings affect the amplitude of the upper midrange response of the C3 component woofer. We recommend that you begin your listening in the "REF" (Reference) and adjust up or down as needed to compensate for mounting location, orientation or personal taste.

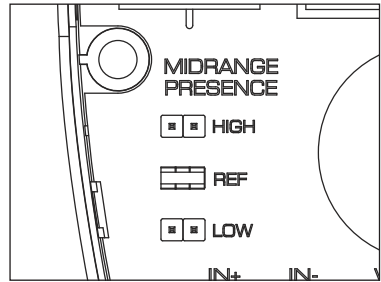

ADJUSTABLE TWEETER LEVEL

C3 crossover networks also provide four levels of tweeter adjustability designed to compensate for different mounting locations, vehicle interiors and personal taste. These levels are selectable via a set of pins located under the clear cover of each crossover case. We recommend that you begin listening in the "REF" (Reference) position. To find the optimum tonal balance in your installation, experiment with alternate tweeter level settings by moving the pins. It is safe to switch jumpers while the system is playing.

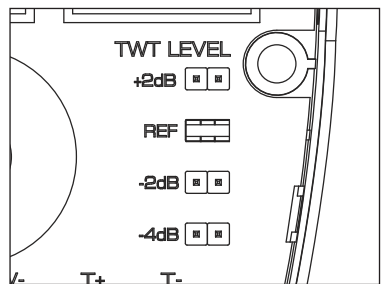

WIRING YOUR SPEAKER SYSTEM

C3 Convertible Components give you the option of installing the speakers as separate component speaker systems or as coaxial systems (tweeters mounted onto the center of each woofer).

Positive (+) and negative (-) connections to the crossover from the amplifier outputs are made with the terminals labeled “IN+” and “IN-”. The Positive and Negative outputs to the woofer connections are labeled “W+” and “W-” on the Crossover and should be connected to corresponding “WFR+” and “WFR-” terminals on the woofer (as illustrated below). The tweeter connections vary by system configuration and may be made in one of two ways.

In component configuration, the tweeter outputs, labeled “T+” and “T-” on the Crossover should be wired directly to the corresponding lead on the tweeter (See Diagram A). In coaxial configuration, the tweeter is connected via an internal jumper (See page 6 for more information) and the Crossover tweeter outputs should be wired to the corresponding “TWT+” and “TWT-” terminals on the woofer (See Diagram B).

!! WARNING

It is absolutely vital that your component system is connected as shown in this manual. Failure to connect the system as shown may result in damage to your speakers which is NOT covered under warranty.

DIAGRAM A: Component System Wiring

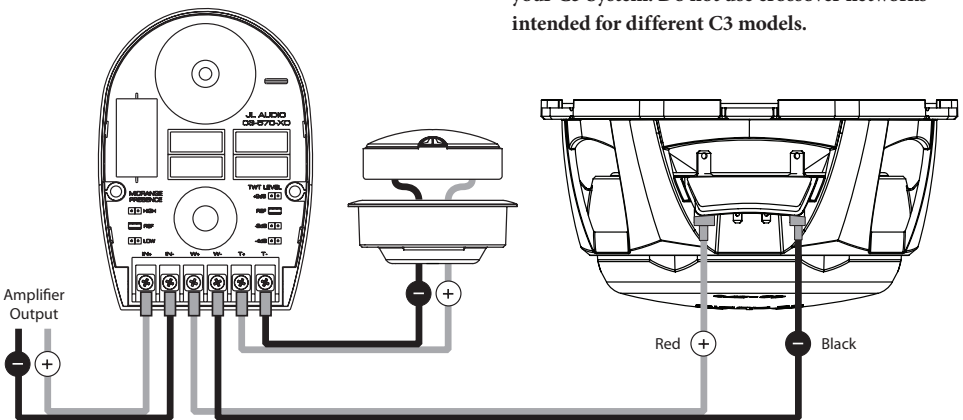

Do not substitute different crossover networks into your C3 System. Do not use crossover networks intended for different C3 models.

DIAGRAM B: Coaxial System Wiring

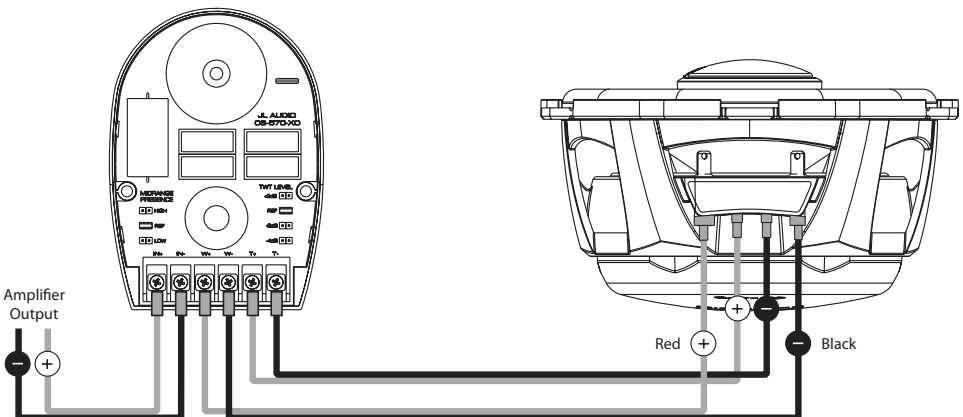

CONVERTIBLE COMPONENTS

C3 Convertible Components give you the option of installing the speakers as separate component speaker systems or as coaxial systems (tweeters mounted onto the center of each woofer).

Note: If the C3 system is to be used in a coaxial configuration, the phase plugs must be removed to accept the tweeter and tweeter post.

Component System Set-Up

The Component configuration of the C3-570 is achieved by wiring the tweeter to the crossover separately and installing the included phase plugs onto the center of each woofer. **The woofers are factory-packaged in the component system configuration with phase plugs installed.**

The phase plugs attach to the woofers using a simple bayonet (twist and lock) mechanism.

To remove the phase plugs, simply apply downward pressure with your thumb and index finger and twist 1/4 turn counterclockwise until released. Then pull the phase plug off the receiver.

To reattach the phase plugs, align the two tabs on the inside of each phase plug with the grooves on the outer diameter of the receiver in the center of the woofer. With these aligned, slide the phase plug down into place until it stops, applying gentle pressure. To lock, push down firmly/evenly on the plug with thumb and index finger and turn 1/4 turn clockwise.

For woofer mounting instructions, please refer to Pages 10-11 of this Manual. For separate tweeter mounting instructions, please refer to Pages 12-13 of this Manual.

Coaxial System Set-Up

The Coaxial configuration of the C3-570 is achieved by installing a tweeter onto the center of each woofer using the supplied coaxial tweeter posts.

First, remove the phase plugs from the woofers (if present) by pushing down firmly/evenly on the plug with thumb and index finger and turning 1/4 turn counter-clockwise to unlock and remove. The phase plugs will not be used in coaxial configuration and should be set aside for possible future use.

Next, route the tweeter's Positive (+) and Negative (-) wire leads through the center of the coaxial tweeter post from the large tweeter-cup end and out the smaller end (See Figure A). The tweeter mounts to the coaxial tweeter post using a simple bayonet (twist and lock) mechanism. To attach the tweeter to the post, observe the indented locking slots on the outer edge of the tweeter body and align these with the tabs visible on the inside walls of the tweeter cup portion of the tweeter post. The tweeter should slide into place easily and can then be locked by pushing down on the tweeter and giving it a small clockwise turn (See Figure B).

With the tweeter installed into the tweeter post, connect the Positive (+) red wire lead on the tweeter to the larger male connection tab in the woofer's center, followed in the same manner, by the Negative (-) black lead to the smaller connection tab. (See Figure C).

Now, note the two tabs on the inside of the bottom end of the tweeter post. Align these tabs to the channels visible on opposite sides of the receiver in the woofer's center. While tucking the wires into the tweeter post, slide the tweeter post down into place until it stops and is ready to be locked. To lock, push down firmly/evenly on the tweeter post with thumb and index finger and turn 1/4 turn clockwise. (See Figure D).

For woofer mounting instructions, please refer to Pages 10-11 of this Manual.

DIAGRAM C: Tweeter Post / Coaxial System Configuration

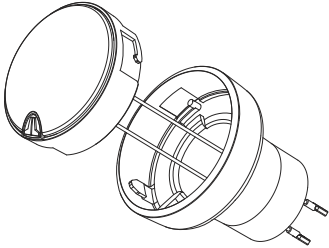

Figure A.

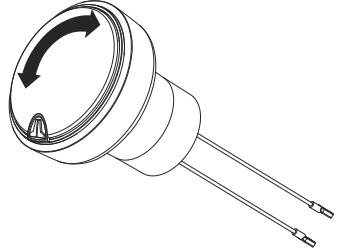

Figure B.

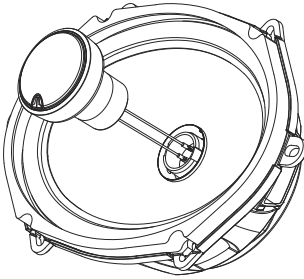

Figure C.

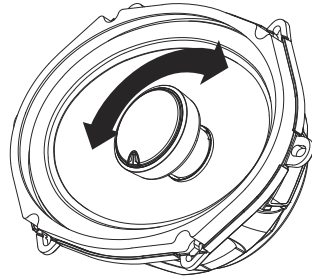
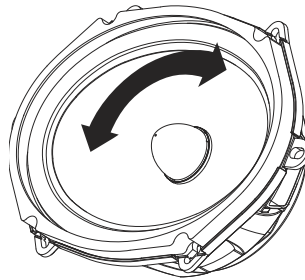
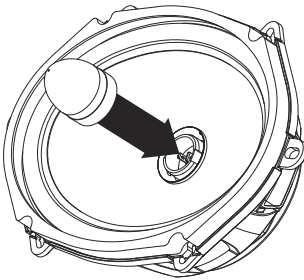

Figure D.

DIAGRAM D: Phase Plug / Component System Configuration



COAXIAL PLACEMENT CONSIDERATIONS

In most cases, speakers in the coaxial configuration will be placed into factory speaker locations. If you have some speaker mounting flexibility, keep the following in mind: Lower mounting locations, such as the lower front corner of a door or a kick-panel provide the greatest path length distances for the sound emitted by the speakers. For this reason, they are generally more desirable than higher mounting locations. Higher mounting locations will usually result in extreme near-side soundstage bias which compromises the stereo listening experience (See Diagram E).

COMPONENT PLACEMENT CONSIDERATIONS

A component system configuration gives you the ability to place the woofer and tweeter separately in your vehicle interior. This can be good or bad, depending on how it's done. As a general rule, the tweeters should be placed relatively close to the woofers for best tonal balance and most coherent imaging (the closer, the better). Any separation greater than 8 inches (20 cm) is likely to result in degraded sound quality (See Diagram H).

Avoid placing tweeters where they will be blocked

DIAGRAM E: COAXIAL CONFIGURATION - Less Desirable Door Speaker Placement

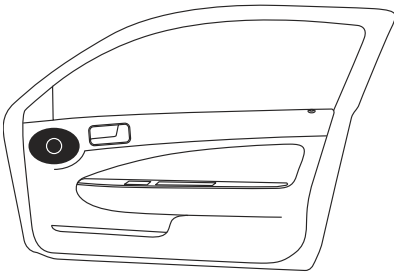
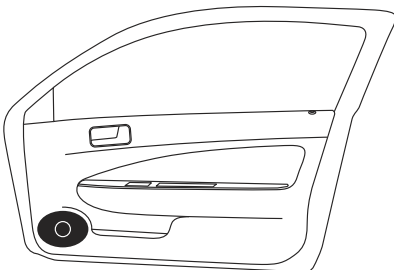

DIAGRAM F: COAXIAL CONFIGURATION - More Desirable Door Speaker Placement



by objects in the interior of the car (including seated occupants). When selecting a mounting location, look at both sides of the car to make sure that this location is clear on both sides.

You can always experiment with tweeter placement before committing to a final mounting location. Simply connect the rest of the system and allow plenty of wire length for the tweeters. Using Velcro® or similar material, attach the tweeters in different locations until you find the one where they perform best.

Woofers will usually be placed into factory speaker locations. If you have some woofer mounting flexibility, keep the following in mind: Lower mounting locations, such as the lower front corner of a door (See Diagram H) or a kick-panel provide the greatest path length distances for the sound emitted by the woofer. For this reason, they are generally more desirable than higher mounting locations. Higher mounting locations often result in extreme near-side soundstage bias which compromises the stereo listening experience (See Diagram G).

DIAGRAM G: COMPONENT CONFIGURATION - Less Desirable Door Speaker Placement

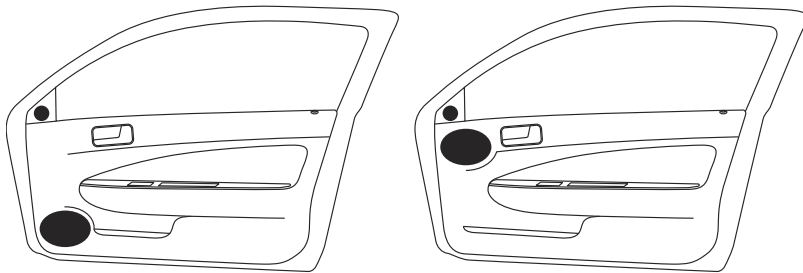
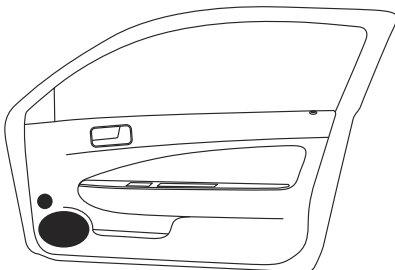

DIAGRAM H: COMPONENT CONFIGURATION - More Desirable Door Speaker Placement



!! WARNING

Double check the clearance for both speakers before proceeding. Many cars are different from one side to the other!

WOOFER INSTALLATION

The woofers should be installed in one of the following ways depending on location:

Factory Location: If you will be using the factory speaker wires, it may be necessary to change the terminations. This may be accomplished by using an adaptor plug or simply by cutting the factory connector off and using the supplied crimp connectors to terminate the speaker wires. The large connector is for the positive (+) terminal and the small connector is for the negative (-) terminal of each woofer. Keep in mind that the woofer wires must be connected to the woofer outputs of the crossovers supplied with your system as shown in the diagram on page 5. If you prefer to run new wires, refer to the “Custom Location” installation section for details. Whichever method you choose, observe correct polarity in your connections. If you are unsure about any of these issues, contact your JL Audio dealer for installation assistance.

Your new speakers have been designed to install, without modifications, into most vehicles that accept a 5x7-inch (125 x 180 mm) speaker. Most factory 5x7-inch speakers use four mounting screws which will line up with the mounting holes on your speakers.

A spacer gasket has been included to fine-tune speaker fitment. This gasket can be mounted on the front of the mounting flange, the back of the mounting flange or simply not be used in the installation.

It is absolutely vital that the speaker frame fits into the mounting hole cleanly. This must be checked prior to tightening the screws. Do not force the frame into a hole that is too small. Do not tighten the speaker onto an uneven surface. This will damage your speakers. The speaker should also fit so that air does not leak around the mounting flange. Air leaks will cause a severe degradation in sound quality. Seal any air leaks with an automotive-grade sealant material.

Connect the speaker wires to both sets of terminals on each speaker, observing correct polarity and making sure that the tweeter and woofer wires correspond to the correct terminals on both the speaker and the crossover.

Secure the speaker and spacer gasket (if applicable) to the panel by evenly tightening by hand mounting screws. Use the supplied mounting clips and the provided #8 x 1.25 inch (32 mm) mounting screws unless the factory holes already feature threaded inserts.

Custom Location: Run speaker wire to the desired mounting locations. If you are running wires into a door, use existing factory wiring boots whenever possible. If you are drilling new holes, file their edges and install rubber grommets into each hole. Wires should then be covered with a protective, flexible PVC sleeve and then run through the door jamb. Make sure that the wires will clear door hinges and other structures in the door. If you are unsure about any part of this process, please contact your JL Audio dealer for installation help.

Select an even surface. Tightening a speaker onto an uneven surface can damage it. Use the supplied template to mark the desired mounting location. Mark the center and the outline of the mounting hole as well as the mounting screw positions. Before drilling or cutting on your interior panels, use a utility knife to cut any fabric, vinyl or leather from hole locations. These materials can easily be snagged by a drill or a saw, causing damage to the panel and possible bodily injury. Drill four 1/8-inch (3 mm) holes for the speaker's mounting screws at the positions you have marked. Also drill a pilot hole in the center of the speaker mounting hole at this time. Then, using a saber saw, make the circular cut out for the speaker. File any rough edges. Insert the mounting clips with the flat side towards the speaker as shown in Diagram I.

It is absolutely vital that the speaker frame fits into the mounting hole cleanly. This must be

checked prior to tightening the screws. Do not tighten the speaker onto an uneven surface! This will damage your speakers. The speaker should also fit so that no air leaks around the mounting flange. Air leaks will cause a severe degradation in sound quality. Seal any air leaks with silicone, rope caulk or similar sealant material.

A spacer gasket has been included to fine-tune speaker fitment. This gasket can be mounted on the front of the mounting flange, the back of the mounting flange or simply not be used in the installation.

Connect the speaker wires to both sets of terminals on each speaker, observing correct polarity and making sure that the tweeter and woofer wires correspond to the correct terminals on both the speaker and the crossover.

Secure the speaker and spacer gasket (if applicable) to the panel by evenly tightening by hand the provided #8 x 1.25 inch (32 mm) mounting screws.

DIAGRAM I: Factory /Custom Location Woofer Installation Options

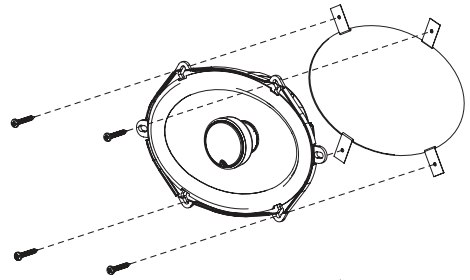

-OR-

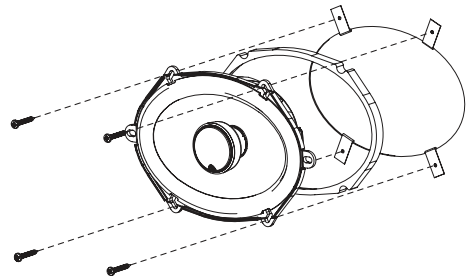

-OR-

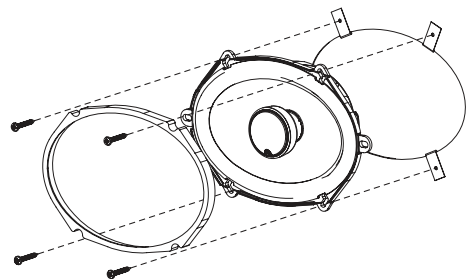

!! WARNING

Hand-tighten the screws evenly in a criss-cross pattern to avoid bending the speaker frame or stripping the mounting clips.

TWEETER INSTALLATION

First, run speaker wires from the tweeter output of the crossover (see Wiring Diagram B on page 5) to the desired tweeter mounting locations, observing the same precautions as mentioned in the woofer installation section. Terminate the wires with the supplied 2.8 mm male crimpable connectors.

TWEETER FIXTURE INSTALLATION:

The dome tweeters supplied with your C3-570 system have been designed for maximum mounting versatility in a component configuration. There are two primary methods by which the tweeters can be mounted in your vehicle:

Flush-Mount Installation

The dome tweeters supplied with your C3-570 system have been designed to integrate with your installation in a clean, unobtrusive manner using a flush-mount cup. This compact mounting fixture is installed using the method illustrated in Diagram J and requires a mounting hole with a diameter of 1.875 in. (47.6 mm).

At least 1.70-inch (43.2 mm) of clearance is required behind the mounting surface of the tweeter for the spring clips and 1-inch machine screws used in mounting the fixture. In limited depth applications, it may be necessary to cut down the length of the machine screw, or to use a shorter screw (not supplied). Hand-tighten the machine screw until the fixture is secure (See Diagram J).

Surface-Mount Installation

In this application, you will not need to cut large holes in your vehicle's panels for the tweeters. You will only need to drill a hole for the wires and two smaller holes for the mounting screws. This application is useful when mounting the tweeters to a panel that has insufficient clearance behind it for the tweeter's magnet structure.

Using the fixture as a template, mark the screw hole locations and a location in the center of the fixture for the wire hole. Remove the fixture and drill pilot holes for the screws and a 1/4-inch (6.4 mm) for the wires. Use the supplied #6 x 1.00-inch sheet metal screws to secure the fixture as shown in Diagram K. Next, route the tweeter's positive (+) and negative (-) wire leads through the 1/4-inch center hole. The tweeter is secured to the fixture using a simple bayonet (twist and lock) mechanism. To attach the tweeter to the surface-mount fixture, observe the indented locking slots on the outer edge of the tweeter body and align these with the tabs visible on the inside walls of the fixture. The tweeter should slide into place easily and can then be locked by pushing down on the tweeter and giving it a small clockwise turn (See Diagram K).

DIAGRAM J: Flush-Mount Tweeter Installation

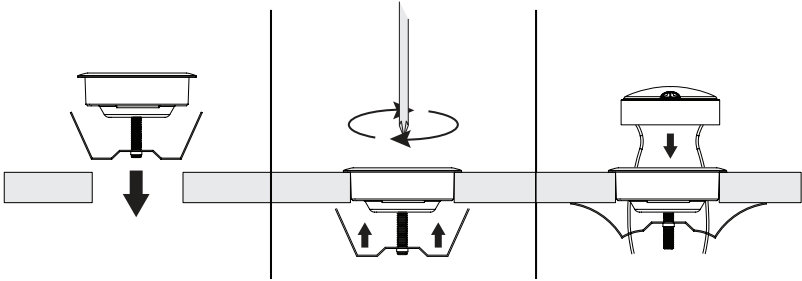
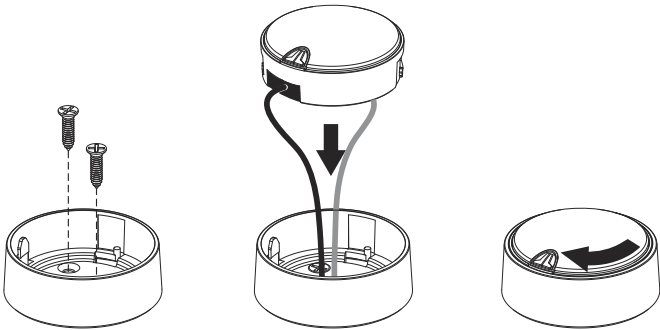

DIAGRAM K: Surface-Mount Tweeter Installation



NOTES

LIMITED WARRANTY - AUTOMOTIVE SPEAKER SYSTEMS (USA)

JL AUDIO warrants these speakers (and crossover networks, where applicable) to be free of defects in materials and workmanship for a period of **one (1) year**.

This warranty is not transferable and applies only to the original purchaser from an authorized JL AUDIO dealer. Should service be necessary under this warranty for any reason due to manufacturing defect or malfunction, JL AUDIO will (at its discretion), repair or replace the defective product with new or remanufactured product at no charge. Damage caused by the following is not covered under warranty: accident, misuse, abuse, product modification or neglect, failure to follow installation instructions, unauthorized repair attempts, misrepresentations by the seller. This warranty does not cover incidental or consequential damages and does not cover the cost of removing or reinstalling the unit(s). Cosmetic damage due to accident or normal wear and tear is not covered under warranty.

Any applicable implied warranties are limited in duration to the period of the express warranty as provided herein beginning with the date of the original purchase at retail, and no warranties, whether express or implied, shall apply to this product thereafter. Some states do not allow limitations on implied warranties, therefore these exclusions may not apply to you. This warranty gives you specific legal rights, and you may also have other rights which vary from state to state.

If you need service on your JL AUDIO product:

All warranty returns should be sent to JL AUDIO freight prepaid through an authorized JL AUDIO dealer and must be accompanied by proof of purchase (a copy of the original sales receipt.) Direct returns from consumers or non-authorized dealers will be refused unless specifically authorized by JL AUDIO with a valid return authorization number. Warranty expiration on products returned without proof of purchase will be determined from the manufacturing date code. Coverage may be invalidated as this date is previous to purchase date. Return only defective components. If one speaker fails in a system, return only that speaker component, not the entire system. Non-defective items received will be returned freight-collect. Customer is responsible for shipping charges and insurance in sending the product to JL AUDIO. Freight damage on returns is not covered under warranty.

For Service Information in the U.S.A. please call

JL Audio Customer Service: (954) 443-1100

9:00 AM – 5:30 PM (Eastern Time Zone)

JL Audio, Inc

10369 North Commerce Pkwy.

Miramar, FL 33025

(do not send product for repair to this address)

International Warranties:

Products purchased outside the United States of America are covered only by that country's distributor and not by JL Audio, Inc.