

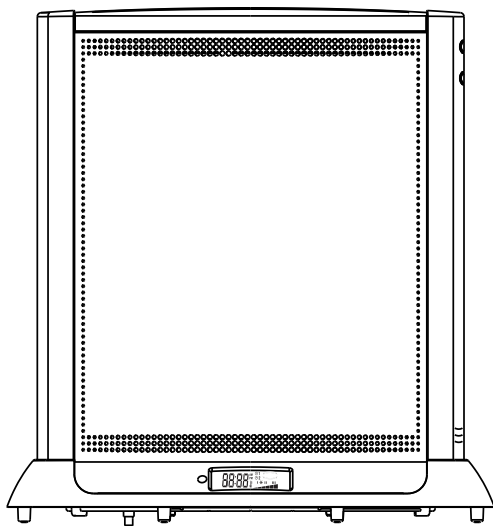

# ELECTRIC RADIATOR ECLIPSE

Instructions for use



SDH2000

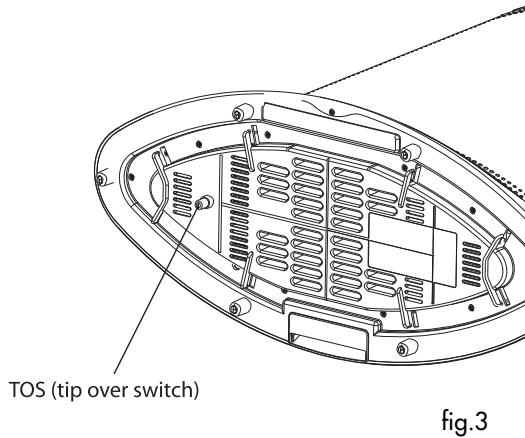
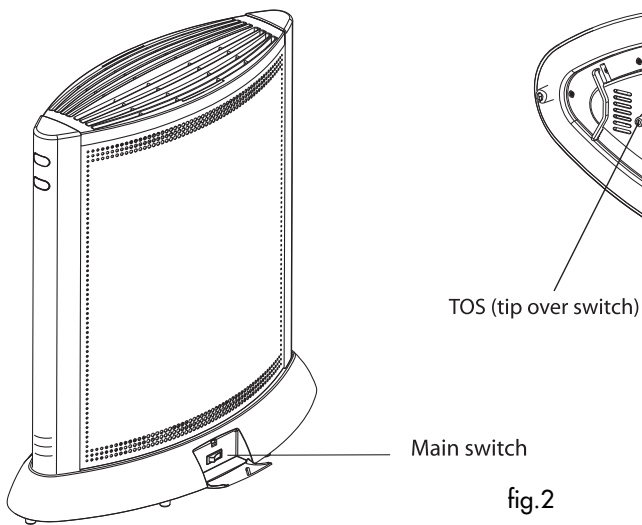
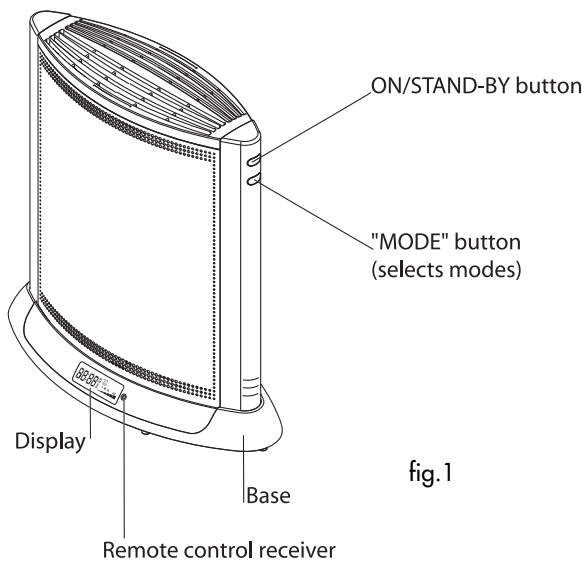

## OPERATION AND USE OF THE ELECTRIC RADIATOR

Thank you for choosing a De'Longhi electric radiator.

For best results and maximum safety, read these instructions carefully before using the radiator.  
Use the appliance for domestic use only!

### ELECTRICAL CONNECTIONS

Before plugging the appliance into the mains socket, check that:

- the mains power supply corresponds to the value indicated on the rating plate on the back of the appliance;
- the power socket and electrical circuit are adequate for the appliance.
- the mains socket matches the plug. If this is not the case, have the plug replaced;
- the mains socket is adequately earthed. **Failure to follow these important safety instructions absolves the manufacturer of all liability.**

### 1. GENERAL INSTRUCTIONS

- The appliance can be operated from either the control panel or the remote control. From the control panel only the mains functions are available while on the remote control all functions are available.
- To start the appliance, open the door at the back (see fig. 2) and turn the main switch on. " - -: - - " is displayed.

**NB:** This replaces the time display until the appliance receives a signal from the remote control. After this, the time set on the remote control is displayed.

- Press the ON/STAND-BY button on the control panel or on the remote control to start the appliance on. The appliance can now be operated from either the control panel or the remote control.

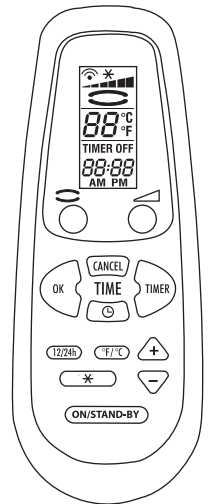

### 2. OPERATION FROM THE REMOTE CONTROL

#### INSERTING OR REPLACING THE BATTERIES

- Remove the cover on the rear of the remote control;
- Insert two R03 "AAA" 1.5V batteries in the correct position (see instructions inside the battery compartment);
- Put the cover back in place.

**NB:** If the remote control unit is replaced or disposed of, the batteries must be removed and disposed of in accordance with current legislation as they are harmful to the environment.







#### SETTING THE TIME

- When the batteries are inserted, the time display starts flashing. Use the + and - buttons until the required time is displayed. Press the + or - buttons and hold them down to run through the minutes and hours quickly.
- To confirm the selected time, press the OK button. When the first command is transmitted from the remote control, the time set on the remote control is shown also on the appliance display.
- When setting the current time, the time can be zeroed quickly by pressing the "CANCEL" button.
- The 12/24h button selects the way the time is displayed on the clock and timer.











### 3. OPERATING FROM THE CONTROL PANEL

- **"ON/STAND-BY" BUTTON:** turns the appliance on in the last mode set or in stand-by awaiting commands.
- **MODE BUTTON:** enables the appliance to be used when the remote control is not available. The "MODE" button can only be used to select the power level (MIN/MED/MAX). Both sides are active

## TABLE OF POWERS:

		Power levels		
		Min 	Med 	Max 
Side	Single panel 	~ 400W	~ 600W	~ 950W
	Single panel 	~ 400W	~ 600W	~ 950W
	Double panel 	~ 800W	~ 1200W	~1900W

## OPERATION

- Select the operating mode using the "" and "" buttons on the remote control.
- The "" button selects the radiating side you want to activate:
  -  front side active.
  -  back side active.
  -  front and back sides active.
- The "" button selects the required radiating power:
  -  : MIN
  -  : MED
  -  : MAX
- Use the + and - buttons to set the comfort temperature.
- The °F/°C button selects the preferred temperature scale.
- The ON/STAND-BY button switches the appliance from STAND-BY to ON and viceversa.
- Press the "" button to activate the frost prevention function. This function keeps automatically the room at a room temperature of 7°C (45°F).

## COUNT DOWN TIMER

Delayed shutdown turns the appliance off automatically at the set time.

To programme, press the "TIMER" button. The display shows the preset time or the time set previously.

Use the + or - buttons to set the time you want the appliance to go off.

Confirm by pressing the OK button. "TIMER OFF" is displayed.

To deactivate programmed shutdown, press the "TIMER" button twice or the "CANCEL" button.

## 4. MAINTENANCE

Before carrying out maintenance, always unplug from the mains and wait for the appliance to cool down.

This radiator requires no particular maintenance.

Simply dust with a soft, dry cloth.

Never use abrasive powders or solvents.

If necessary, remove accumulations of dirt using a vacuum cleaner.

## 5. IMPORTANT SAFEGUARDS

- When you turn the appliance on for the first time, operate it at maximum for at least two hours. During this time, you should ventilate the room to eliminate the "new" smell given off. It is normal for the appliance to make "squeaking" noises when first turned on.
- Never use the radiator near baths, sinks, showers or swimming pools.
- Never use the radiator to dry laundry.
- Never lay the power cable on top of the radiator when it is hot.
- Use the radiator in a vertical position only.

- If the power cable is damaged, it must be replaced by the manufacturer, an authorised technical service centre or qualified personnel in order to avoid all risk.
- You are recommended to keep the appliance out of draughts as they could reduce efficiency.
- Prolonged use is not recommended as the radiator could overheat.
- As with all electrical appliances, the instructions aim to cover the largest possible number of situations. Caution and common sense should nevertheless be used when operating the appliance, particularly in the presence of children.
- This appliance is not intended for use by persons (including children) with reduced physical, sensory or mental capabilities, or lack of experience and knowledge, unless they have been given supervision or instruction concerning the use of the appliance by a person responsible for their safety. Young children should be supervised to ensure that they do not play with the appliance
- Position the appliance in such a way that the plug and socket are easily accessible even after installation.
- Do not use the appliance in rooms with a surface area of less than 4 m<sup>2</sup>.
- The appliance is fitted with a **tip-over switch** (fig. 3) which turns the appliance off if it falls over. To restart the appliance, simply place it upright again.
- Do not locate the heater immediately below the GPO socket-outlet.
- **A safety device shuts the radiator down** in the case of accidental overheating. To reset, unplug the appliance from the mains socket for a few minutes, remove the cause of overheating then plug in again.
- **Warning: In order to avoid overheating , do not cover.**



**Important:** never under any circumstances cover the appliance during operation as this would lead to dangerous overheating of the appliance itself.

