



18 GAUGE FINISH ANGLE NAILER

MODEL H5570

INSTRUCTION MANUAL



COPYRIGHT © SEPT, 2003 BY GRIZZLY INDUSTRIAL, INC.

WARNING: NO PORTION OF THIS MANUAL MAY BE REPRODUCED IN ANY SHAPE OR FORM WITHOUT THE WRITTEN APPROVAL OF GRIZZLY INDUSTRIAL, INC.

PRINTED IN TAIWAN

ONLINE MANUAL DISCLAIMER

THE INFORMATION IN THIS MANUAL REPRESENTS THE CONFIGURATION OF THE MACHINE AS IT IS CURRENTLY BEING SHIPPED. THE MACHINE CONFIGURATION CAN CHANGE AS PRODUCT IMPROVEMENTS ARE INCORPORATED. IF YOU OWN AN EARLIER VERSION OF THE MACHINE, THIS MANUAL MAY NOT EXACTLY DEPICT YOUR MACHINE. CONTACT CUSTOMER SERVICE IF YOU HAVE ANY QUESTIONS ABOUT DIFFERENCES.

PREVIOUS VERSIONS ARE NOT AVAILABLE ONLINE.

SAFETY

WARNING

For Your Own Safety Read Instruction Manual Before Operating This Equipment

The purpose of safety symbols is to attract your attention to possible hazardous conditions. This manual uses a series of symbols and signal words which are intended to convey the level of importance of the safety messages. The progression of symbols is described below. Remember that safety messages by themselves do not eliminate danger and are not a substitute for proper accident prevention measures.

DANGER

Indicates an imminently hazardous situation which, if not avoided, WILL result in death or serious injury.

WARNING

Indicates a potentially hazardous situation which, if not avoided, COULD result in death or serious injury.

CAUTION

Indicates a potentially hazardous situation which, if not avoided, MAY result in minor or moderate injury. It may also be used to alert against unsafe practices.

NOTICE

This symbol is used to alert the user to useful information about proper operation of the equipment.

WARNING

Safety Instructions For Pneumatic Tools

1. **KEEP ALL SAFETY DEVICES IN PLACE** and in working order.
2. **REMOVE ADJUSTING KEYS AND WRENCHES.** Form habit of checking to see that keys and adjusting wrenches are removed from tool before operation.
3. **KEEP WORK AREA CLEAN.** Cluttered areas and benches invite accidents.
4. **DO NOT USE IN DANGEROUS ENVIRONMENT.** DO NOT use pneumatic tools in damp or wet locations, or where any flammable or noxious fumes may exist. Keep work area well lighted.
5. **KEEP CHILDREN AND VISITORS AWAY.** All children and visitors should be kept at a safe distance from work area.
6. **MAKE WORKSHOP CHILD PROOF** with padlocks, master switches, or by removing air hoses from tools.
7. **DO NOT FORCE TOOL.** It will do the job better and safer at the rate for which it was designed.
8. **USE THE RIGHT TOOL.** DO NOT force tool or attachment to do a job for which it was not designed.
9. **DO NOT USE UNDER THE INFLUENCE OF DRUGS OR ALCOHOL.**

WARNING

Safety Instructions For Pneumatic Tools

10. **USE PROPER AIR HOSE** for the tool. Make sure your air hose is in good condition and is long enough to reach your work without stretching.
11. **WEAR PROPER APPAREL.** DO NOT wear loose clothing, gloves, neckties, rings, bracelets, or other jewelry which may get caught in moving parts. Non-slip footwear is recommended. Wear a protective hair covering to contain long hair.
12. **ALWAYS USE SAFETY GLASSES.** Also use a face or dust mask if cutting operation is dusty. Everyday eyeglasses only have impact resistant lenses, they are NOT safety glasses.
13. **WEAR APPROVED HEARING PROTECTION.**
14. **SECURE WORK.** Use clamps or a vise to hold work when practical. It is safer than using your hand and frees both hands to operate tool.
15. **DO NOT OVERREACH.** Keep proper footing and balance at all times.
16. **MAINTAIN TOOLS WITH CARE.** Keep tools lubricated and clean for best and safest performance. Follow instructions for lubricating and changing accessories.
17. **REDUCE THE RISK OF UNINTENTIONAL STARTING.** DO NOT carry tool with hand on trigger and always disconnect from air when not in use.
18. **DISCONNECT TOOLS** before servicing and changing accessories.
19. **USE THE RECOMMENDED ACCESSORIES.** Consult the owner's manual for recommended accessories. The use of improper accessories may cause risk of injury.
20. **CHECK DAMAGED PARTS.** Before further use of the tool, a guard or other part that is damaged should be carefully checked to determine that it will operate properly and perform its intended function. Check for alignment of moving parts, binding of moving parts, breakage of parts, mounting, and any other conditions that may affect its operation. A guard or other part that is damaged should be properly repaired or replaced.
21. **NEVER LEAVE UNATTENDED TOOL CONNECTED TO AIR.** Disconnect the air hose and DO NOT leave tool until it is relieved of any built up pressure.
22. **NEVER ALLOW UNTRAINED USERS TO USE THIS TOOL WHILE UNSUPERVISED.**
23. **IF YOU ARE UNSURE OF THE INTENDED OPERATION, STOP USING THE TOOL.** Seek formal training or research books or magazines that specialize in pneumatic tools.

WARNING

Basic Nailer Safety

In addition to the rules stated in the previous section, and those in the warning boxes throughout this manual, please observe the following safety tips for your new nailer:

1. **READ THIS ENTIRE MANUAL BEFORE OPERATING THE NAILER.**
2. **ALWAYS DISCONNECT AIR FROM THE NAILER WHENEVER SERVICING OR INSTALLING NAILS.** During maintenance, a nailer connected to air may fire accidentally, causing serious personal injury.
3. **DO NOT PLACE HANDS NEAR NAIL POINT OF ENTRY.** Nail can deflect and tear through the surface of the workpiece, puncturing your hand or fingers.
4. **NEVER CONNECT THE NAILER TO PRESSURIZED OXYGEN OR OTHER COMBUSTIBLE GASES AS A POWER SOURCE.** Only use filtered, lubricated, and regulated compressed air.
5. **NEVER USE GASOLINE OR OTHER FLAMMABLE LIQUIDS TO CLEAN THE NAILER.** Vapors in the tool will ignite by a spark and cause the tool to explode.
6. **DO NOT CARRY THE NAILER BY ANY OTHER PART THAN THE HANDLE,** and do not carry the nailer by the air hose.
7. **DO NOT KEEP THE TRIGGER PULLED ON THE SAFETY YOKE MECHANISM WHEN CARRYING OR HOLDING THE TOOL.**
8. **DO NOT USE A CHECK VALVE OR ANY OTHER FITTING THAT ALLOWS AIR TO REMAIN IN THE TOOL.**

WARNING

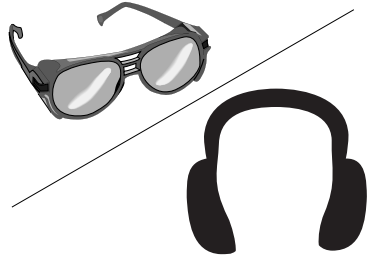

Operating this nailer can propel objects into the air, causing immediate eye damage. To protect yourself, always wear American National Standards Institute (ANSI) approved safety glasses or goggles when operating this equipment. In addition, this nailer discharges at 85-90 decibels. To protect your hearing, always wear ANSI approved ear protection when operating this nailer.

WARNING



Never point this nailer at yourself or another person! Always pay attention to the direction this nailer is pointed. Use this tool with respect and caution to lessen the possibility of operator or bystander injury. Ignoring this warning may result in serious personal injury.

INTRODUCTION

Commentary

We are proud to offer the Grizzly Model H5570 18 Gauge Finish Angle Nailer. This model is part of a growing Grizzly family of fine power tools. When used according to the guidelines set forth in this manual, you can expect years of trouble-free, enjoyable operation and proof of Grizzly's commitment to customer satisfaction.

We are pleased to provide this manual with the Model H5570. It was written to encourage safety considerations and guide you through general operating procedures and maintenance. This manual represents our effort to produce the best documentation possible.

The specifications, details, and photographs in this manual represent the Model H5570 as supplied when the manual was prepared. However, owing to Grizzly's policy of continuous improvement, changes may be made at any time with no obligation on the part of Grizzly. If you have any comments regarding this manual, please write to us at the address below:

Grizzly Industrial, Inc.
% Technical Documentation
P.O. Box 2069
Bellingham, WA 98227-2069

Most importantly, we stand behind our tools. If you have any service questions or parts requests, please call or write us at the location listed below.

Grizzly Industrial, Inc.
1203 Lycoming Mall Circle
Muncy, PA 17756
Phone: (570) 546-9663
Fax: (800) 438-5901

E-Mail: techsupport@grizzly.com
Web Site: <http://www.grizzly.com>

!WARNING

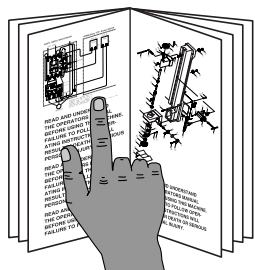

Read the manual before assembly and operation. Become familiar with this tool, its safety instructions, and its operation before beginning any work. Serious personal injury may result if safety or operational information is not understood or followed.

Compressed Air System

The Model H5570 is designed to be operated at 70-100 psi. **DO NOT exceed the maximum operating pressure for your model.**

Before using your new nailer, install the included 1/4" NPT male quick connect fitting on the nailer and a 1/4" NPT female fitting on the air hose. Regulate the air pressure on your air compressor to barely over the minimum psi for your model.

Many pneumatic tools benefit from an in-line filter/lubricator/regulator unit. Using this unit protects your tool from damaging water build-up, allows you to adjust and maintain constant air pressure to your tool, and saves you the inconvenience of having to manually lubricate your tool every time you use it. Check the current Grizzly catalog for availability of this unit. If you plan on installing a filter/lubricator/regulator unit in your compressed air system, always follow the connection instructions that come with the unit.

! WARNING

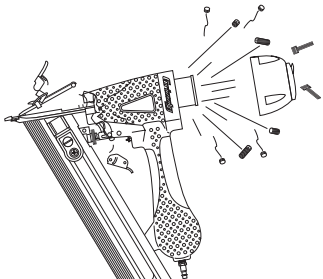

Exceeding the maximum permissible operating pressure may cause the nailer to explode, blowing metal fragments in all directions. To protect yourself from serious personal injury, DO NOT allow your air compressor to exceed the recommended pressure when connected to this nailer!

Safety Yoke Mechanism

A safety yoke mechanism (bump fire) on the nose of the nailer acts as a secondary safety device. When the trigger is pressed, the nailer will not fire until the safety yoke mechanism is depressed.

Before you use your nailer for the first time, check the safety yoke mechanism to ensure proper function. To do this:

1. **Make sure the nailer is disconnected from the air supply!**
2. Make sure the magazine is empty and contains no nails.
3. Make sure the trigger and the safety yoke mechanism move up and down without sticking.
4. Connect the nailer to the air supply.
5. **Without pressing the trigger**, depress the safety yoke mechanism against a scrap piece of wood that is clean and free of any knots, nails, or other foreign objects. If the nailer does not fire, then the safety yoke mechanism is working correctly. If the nailer **does fire** when you do this, immediately disconnect the nailer from the air supply and call our customer service for help.

Similarly if the nailer fires when the trigger is pulled, without the safety yoke mechanism being depressed, then the nailer is not working properly.

If either of these two conditions develop after you have used your nailer for a period of time, check the lubrication of these mechanisms.

! WARNING

The safety yoke is a mechanical device that can fail. Never rely on the safety yoke mechanism as an excuse to point the nailer at yourself or any bystanders. Serious injury may occur.

OPERATION

Oiling Nailer

Special oil has been included with your new Grizzly nailer to help maintain its useful life. Place one drop of oil in the nailer air inlet (as shown in **Figure 1**) before every use. Wipe off any excess oil near the nailer exhaust to avoid dust build-up. When the oil that was included with the nailer has been completely used, replace with Grizzly Model G2820 Pneumatic Tool Oil.

Another option to manual oiling would be to install a lubricator in your air compressor line. If your air compressor line already has a lubricator, then regular lubrication of your nailer will not be necessary. Just make sure there is always oil in the lubricator.

As mentioned before, the best option is to install a filter/lubricator/regulator unit such as the Grizzly Model H4196 in your air line.

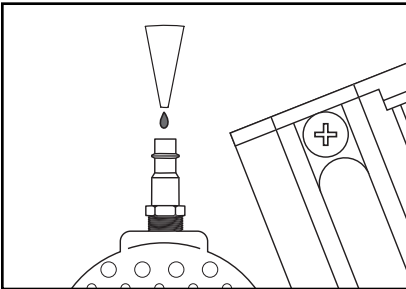

Figure 1. Lubricating nailer via air inlet.

Loading Nailer

When replacing nails in your Model H5570, follow these guidelines:

Gauge: 18
Length: $\frac{3}{4}$ "-2"
Capacity: 100

To load your nailer:

1. **Disconnect the air supply from the nailer!**
2. Slide back the magazine pusher until it stops as shown in **Figure 2**.

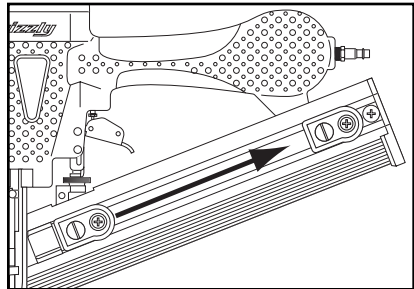

Figure 2. Releasing magazine pusher.

3. Load a nail stick in the T-slot at the top of the magazine as shown in **Figure 3**.
4. Release the magazine pusher by pulling it back, depressing the release button, and sliding it forward.

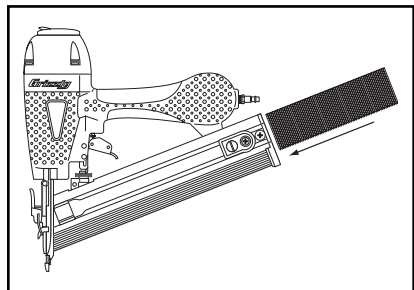

Figure 3. Loading finish nails into nailer.

Operating Nailer

If you have not read the safety instructions in this manual, DO NOT operate the nailer.

Before you operate your nailer, place one drop of the included oil into the quick connect fitting where the nailer connects to the air supply.

To operate your nailer:

1. Connect the air supply to the quick connect fitting.
2. Test the loaded nailer for proper nail penetration. Hold the nailer perpendicular to the surface of a piece of clean scrap wood that is thick enough for the length of finish nails you have loaded. Depress the safety yoke mechanism on your workpiece.

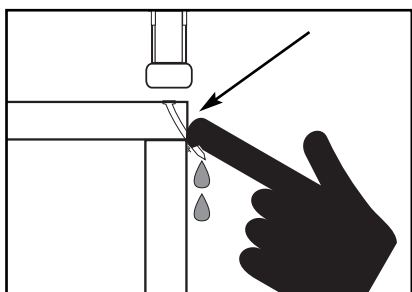

Figure 4. Example of nail deflection.

3. Before pressing the trigger, make sure your free hand is positioned out of the way of a potential path of a nail in case of deflection. (Deflection is caused when grain irregularities, knots or foreign objects inside the wood cause the nail to change its path, resulting in the nail puncturing the surface of the workpiece as shown in **Figure 4.**) Besides damaging your workpiece, deflection can cause injury if your free hand is securing the workpiece in the location that the nail deflects.
4. Press the trigger. If the finish nail drove into the wood far enough, continue with your intended operations. If the nail either went too far or not far enough, then adjust the depth adjustment knob.
5. Turn the knob clockwise to drive the nail deeper, or counterclockwise if the nail is going too deep. (**Figure 5.**)

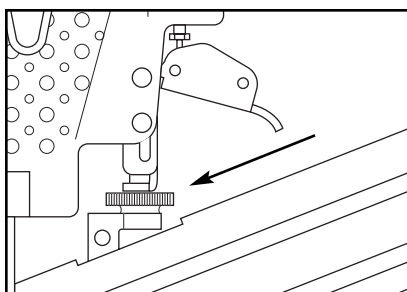

Figure 5. Depth adjustment knob.

Clearing Jammed Nails

To clear a jammed nail from the discharge area on the Model H5570:

1. **Disconnect the nailer from the air supply!**
2. Pull the spring loaded pusher all the way back and remove the nail stick.
3. Flip up the quick release latch located on top of the nailer nose assembly as shown in **Figure 6**.
4. Remove the driver guide cover as shown in **Figure 7**.
5. The jammed nail should now be visible; remove it from the discharge area with needle nose pliers.
6. Replace the driver guide cover and snap the quick release latch back into operating position.

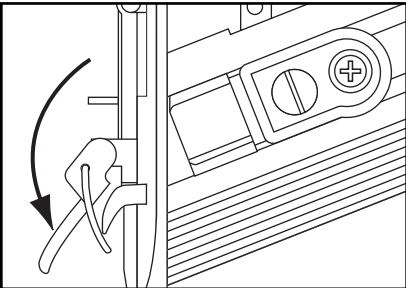

Figure 6. Releasing guide cover latch.

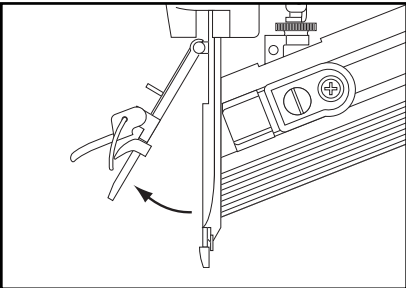
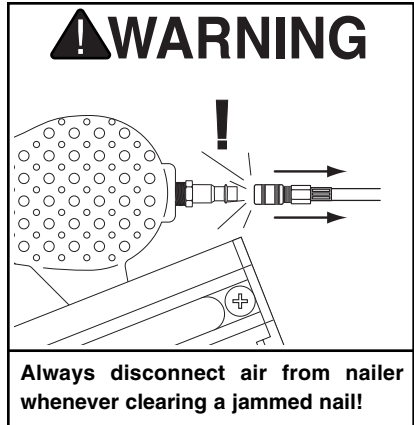

Figure 7. Removing driver guide cover.



Cleaning Nailer

Use a good solvent to clean the nose assembly of the nailer. Always be sure that the nailer is dry before using it again.

Do not allow dust, chips, sand, etc. into the air connectors or into the body of the nailer; this may result in leaks and damage to the nailer and the air couplings.



Replacing Pistons/O-Rings

If you use your nailer day in and day out, Grizzly offers repair pistons as cheap insurance against wasted down time and lost profits in the event that a piston or piston shaft becomes worn out.

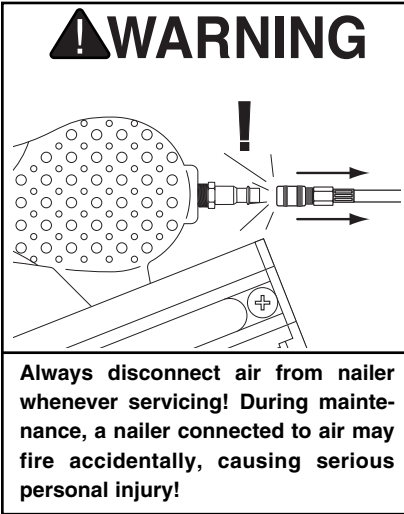

To replace a piston:

1. **Disconnect the nailer from the air supply!**
2. Remove all nails from the magazine cartridge.
3. Remove the 4 cap screws on the back of the nailer, near the exhaust port.
4. Remove the rear cap as shown in **Figure 8**.

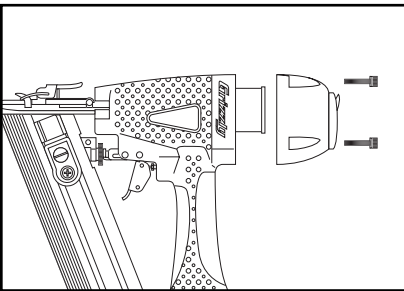
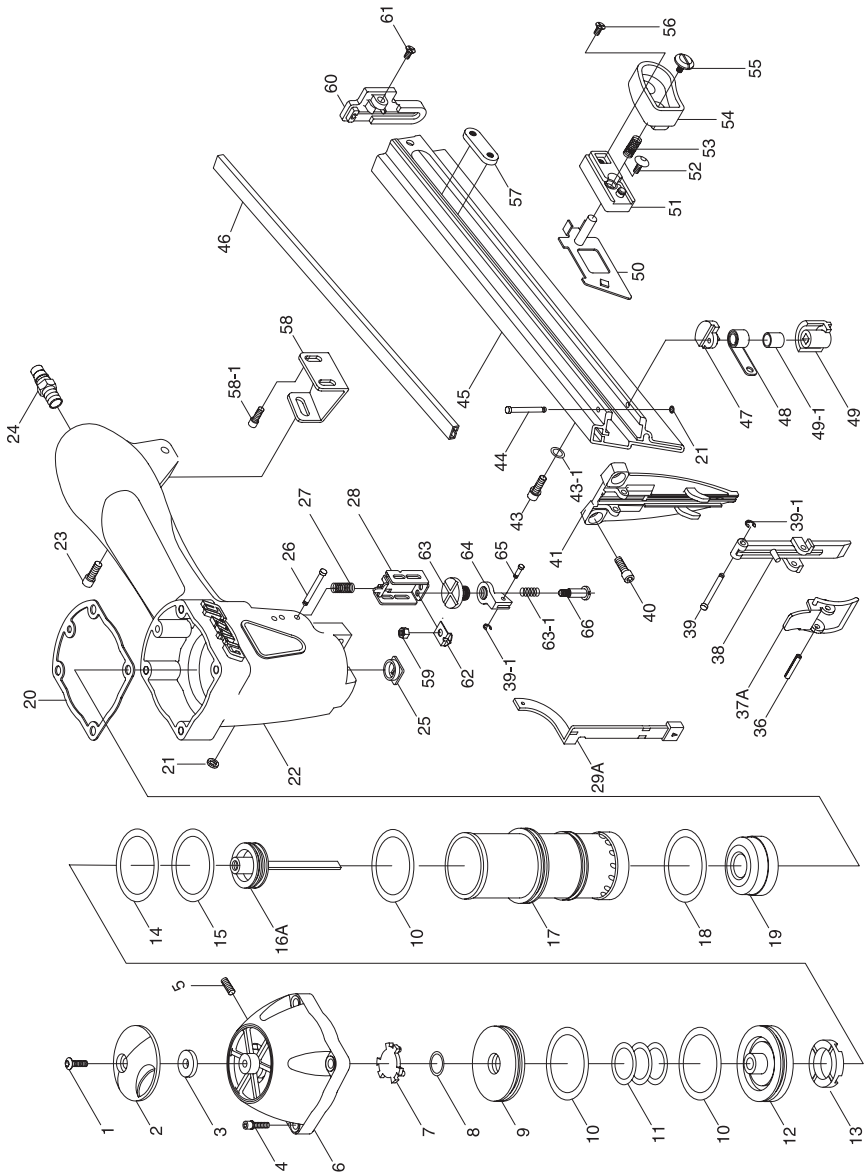

Figure 8. Removing rear cap.

5. The top of the piston should now be visible inside the cylinder, which is housed in the head of the nailer.
6. Open the magazine.
7. Watch the discharge area and push the top of the piston with your finger. You will see the piston shaft slide down the discharge area.
8. With a long flathead screwdriver or similarly shaped tool, push the piston shaft back inside the nailer until you can grip the piston head and remove it from the cylinder. (Be careful not to scratch the discharge area when pushing the piston shaft with the screwdriver.)
9. Place a new O-ring on the new piston and apply a thin film of the nailer lubricating oil on the O-ring.
10. Insert the new piston in the cylinder. Make sure that the grooves on the piston shaft line up with those on the guide at the bottom of the cylinder. The new piston should easily slide into the cylinder. **DO NOT force the piston into the cylinder!** If the piston is not easily inserted, double-check the alignment of the piston shaft with the grooves on the guide.
11. After the piston is inserted correctly, close the magazine. Replace the rear cap assembly and tighten the 4 cap screws.
12. For more assistance, or to install a complete O-ring set, refer to the appropriate breakdown diagram in the back of this manual.

H5570 PART BREAKDOWN



REF	PART #	DESCRIPTION
01	PSB113M	BTN CAP SCR M5-.8 X 11
02	PH5570002	EXHAUST COVER
03	PH5570003	SEAL
04	PSB15M	CAP SCREW M5-.8 X20
05	PSS08M	SET SCREW M4-.7 X 5
06	PH5570006	CAP
07	PH5570007	PISTON STOPPER
08	PH5570008	O RING
09	PH5570009	COLLAR
10	PH5570010	O RING
11	PH5570011	SPRING
12	PH5570012	PISTON HEAD VALVE
13	PH5570013	STOPPER
14	PH5570014	O RING
15	PH5570015	O RING
16A	PH5570016A	DRIVER ASSEMBLY
17	PH5570017	CYLINDER
18	PH5570018	O RING
19	PH5570019	BUMPER
20	PH5570020	GASKET
21	PH5570021	O RING
22	PH5570022	BODY
23	PSB24M	CAP SCREW M5-.8 X 16
24	PH5570024	1/4" NPT MALE CONNECT
25	PH5570025	DRIVER GUIDE WASHER
26	PH5570026	PIN
27	PH5570027	SPRING
28	PH5570028	GUIDE SAFETY LEVER
29A	PH5570029A	SAFETY LEVER
36	PRP42M	ROLLED PIN M3 X 20
37A	PH5570037A	LATCH
38	PH5570038	DRIVER GUIDE COVER
39	PH5570039	PIN
39-1	PEC01M	E RING 3MM

REF	PART #	DESCRIPTION
40	PSB33M	CAP SCREW M5-.8 X 12
41	PH5570041	DRIVER GUIDE
43	PSB97M	CAP SCREW M5-.8 X 6
43-1	PLW01M	LOCK WASHER 5MM
44	PH5570044	PIN
45	PH5570045	MAGAZINE
46	PH5570046	NAIL GUIDE LINER
47	PH5570047	UPPER COVER
48	PH5570048	SPIRAL SPRING
49	PH5570049	COVER
49-1	PH5570049-1	ROLLER
50	PH5570050	PUSHER
51	PH5570051	FOLLOWER SEAT
52	PH5570052	SPECIAL SCR M4-.7 X 6
53	PH5570053	SPRING
54	PH5570054	FOLLOWER BODY
55	PH5570055	SPECIAL SCR M4-.7 X 6
56	PS09M	PHLP HD SCR M5-.8 X 10
57	PH5570057	SET PLATE
58	PH5570058	BRACKET
58-1	PSB18M	CAP SCREW M4-.7 X 8
59	PLN01M	LOCK NUT M4-.7
60	PH5570060	TAIL COVER
61	PHTEK26M	TAP SCREW M5-.8 X 10
62	PH5570062	POSITIONING PLATE
63	PH5570063	DEPTH ADJUST KNOB
63-1	PH5570063-1	SPRING
64	PH5570064	GUIDE PLATE
65	PH5570065	PIN
66	PH5570066	SET SHAFT
*67	PH5570067	CARRYING CASE
*68	PAW3M	ALLEN WRENCH 3MM
*69	PAW4M	ALLEN WRENCH 4MM

* These items are not shown in the illustration.

TROUBLESHOOTING

PROBLEM	CAUSE	ACTION
Air leaking at trigger valve area.	1. O-rings in trigger valve housing are damaged.	1. O-rings must be replaced & operation of safety yoke must be checked.
Air leaking between housing and hose.	1. Loose screws in housing. 2. Damaged O-ring. 3. Loose air fitting.	1. Tighten screws. 2. Replace O-ring. 3. Tighten air fitting.
Air leaking between housing and cap assembly.	1. Damaged seal.	1. Replace damaged seals.
Tool skips nails while discharging.	1. Air leaks. 2. Dirt in nose. 3. Dirt or damage prevents nails from moving freely in magazine. 4. Inadequate air flow to tool. 5. Worn O-ring on piston or lack of lubrication. 6. Damaged O-rings on trigger valve. 7. Worn bumper. 8. Cap seal leaking.	1. Tighten screws and fittings. 2. Clean nose. 3. Clean magazine and inspect/repair damage. 4. Check fitting, hose, compressor & air pressure. 5. Replace piston O-ring. Lubricate. 6. Replace trigger valve O-rings. 7. Replace bumper. 8. Replace cap seal.
Tool runs slowly or has a loss of power.	1. Nailer is not sufficiently lubricated. 2. Broken spring in cap assembly. 3. Exhaust port in cap is blocked.	1. Lubricate nailer. 2. Replace spring. 3. Clean or replace damaged internal parts.
Fasteners frequently jam the nailer.	1. Nails are the wrong size. 2. Nails are bent. 3. Magazine or nose screws are loose. 4. Driver or driver guide are worn or damaged. 5. Nails are wrong angle.	1. Use correct nails. 2. Use undamaged nails. 3. Tighten magazine and nose screws. 4. Replace worn or damaged parts. 5. Use correct angle nails.
Nailer does not fire.	1. Nail is jammed in magazine or discharge area. 2. Piston shaft is damaged. 3. Air pressure too low.	1. Clear nailer magazine or discharge area. 2. Replace piston shaft. 3. Check/increase air pressure.

WARRANTY AND RETURNS

Grizzly Industrial, Inc. warrants every product it sells for a period of **1 year** to the original purchaser from the date of purchase. This warranty does not apply to defects due directly or indirectly to misuse, abuse, negligence, accidents, repairs or alterations or lack of maintenance. This is Grizzly's sole written warranty and any and all warranties that may be implied by law, including any merchantability or fitness, for any particular purpose, are hereby limited to the duration of this written warranty. We do not warrant or represent that the merchandise complies with the provisions of any law or acts unless the manufacturer so warrants. In no event shall Grizzly's liability under this warranty exceed the purchase price paid for the product and any legal actions brought against Grizzly shall be tried in the State of Washington, County of Whatcom.

We shall in no event be liable for death, injuries to persons or property or for incidental, contingent, special, or consequential damages arising from the use of our products.

To take advantage of this warranty, contact us by mail or phone and give us all the details. We will then issue you a "Return Number," which must be clearly posted on the outside as well as the inside of the carton. We will not accept any item back without this number. Proof of purchase must accompany the merchandise.

The manufacturers reserve the right to change specifications at any time because they constantly strive to achieve better quality equipment. We make every effort to ensure that our products meet high quality and durability standards and we hope you never need to use this warranty.

Please feel free to write or call us if you have any questions about the machine or the manual.

Grizzly Industrial, Inc.
1203 Lycoming Mall Circle
Muncy, PA 17756
Phone: (570) 546-9663
Fax: (800) 438-5901

E-Mail:
techsupport@grizzly.com

Web Site: <http://www.grizzly.com>

Thank you again for your business and continued support. We hope to serve you again soon!

WARRANTY CARD

Name _____
Street _____
City _____ State _____ Zip _____
Phone Number _____ E-Mail _____ FAX _____
Model # _____ Serial# _____ Order # _____

The following information is given on a voluntary basis. It will be used for marketing purposes to help us develop better products and services. Of course, all information is strictly confidential.

- How did you learn about us?
 Advertisement Friend
 Catalog Card Deck
 World Wide Web
 Other _____
- What is your annual household income?
 \$20,000-\$29,999 \$60,000-\$69,999
 \$30,000-\$39,999 \$70,000-\$79,999
 \$40,000-\$49,999 \$80,000-\$89,999
 \$50,000-\$59,999 \$90,000 +
- What is your age group?
 20-29 50-59
 30-39 60-69
 40-49 70 +
- How long have you been a woodworker?
 0 - 2 Years 8 - 20 Years
 2 - 8 Years 20+ Years
- How would you rank your woodworking skills?
 Simple Advanced
 Intermediate Master Craftsman
- What stationary woodworking tools do you own? Check all that apply.
 Air Compressor Panel Saw
 Band Saw Planer
 Drill Press Power Feeder
 Drum Sander Radial Arm Saw
 Dust Collector Shaper
 Spindle Sander Jointer
 Table Saw Lathe
 Mortiser Wide Belt Sander
 Horiz. Boring Machine
 Vacuum Veneer Press
 Other _____
- How many of your woodworking machines are Grizzly? _____
- Which benchtop tools do you own? Check all that apply.
 1"x42" Belt Sander 6" - 8" Grinder
 5" - 8" Drill Press Mini Lathe
 8" Table Saw 8" - 10" Bandsaw
 Scroll Saw Disc/Belt Sander
 Spindle/Belt Sander Mini Jointer
 10"-12" Thickness Planer
 Other _____
- How many of the machines checked above are Grizzly? _____
- Which portable/hand held power tools do you own? Check all that apply.
 Belt Sander Orbital Sander
 Biscuit Joiner Palm Sander
 Circular Saw Portable Planer
 Detail Sander Saber Saw
 Drill/Driver Reciprocating Saw
 Miter Saw Router
 Other _____
- What machines/supplies would you like Grizzly Industrial to carry?

- What new accessories would you like Grizzly Industrial to carry?

- What other companies do you purchase your tools and supplies from?

- Do you think your purchase represents good value?
 Yes No
- Would you recommend Grizzly to a friend?
 Yes No
- Would you allow us to use your name as a reference for Grizzly customers in your area? **Note: We never use names more than three times.**
 Yes No
- Comments: _____

Send a Grizzly Catalog to a friend:

Name_____
Street_____
City_____State_____Zip_____

FOLD ALONG DOTTED LINE

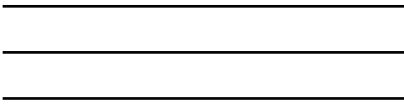

Place
Stamp
Here



GRIZZLY INDUSTRIAL, INC.
P.O. BOX 2069
BELLINGHAM, WA 98227-2069



TAPE ALONG EDGES--PLEASE DO NOT STAPLE