

Radio / Cassette

Hollywood C30 Melbourne C30

Operating instructions



 **BLAUPUNKT**

Open here
Ouvrir s.v.p.
Por favor, abrir
Favor abrir

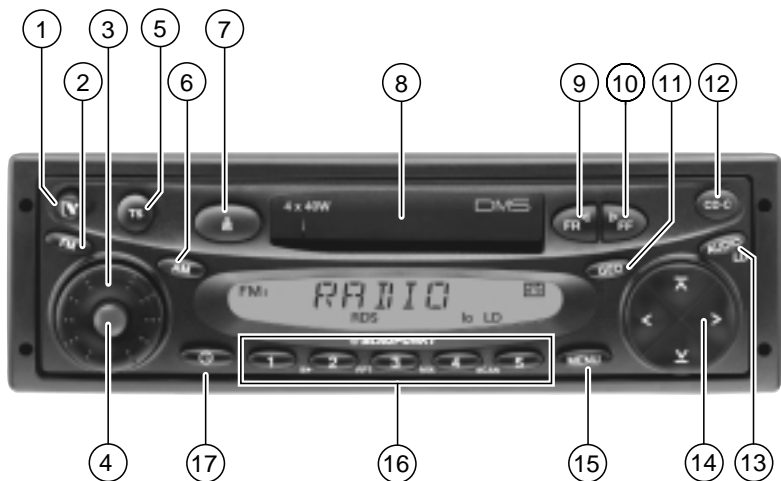

CONTROLS

- ① **[🔒]** button to unlock release panel
- ② **FM** button, selects the FM memory bank
- ③ Volume control knob
- ④ **ON** button, switches the unit on/off
- ⑤ **TS** button, starts the TravelStore function
- ⑥ **AM** button, selects the AM waveband
- ⑦ Tape eject button
- ⑧ Tape slot
- ⑨ **FR** button, fast rewind
- ⑩ **FF** button, fast forward
- ⑪ **GEO** button, adjusts balance and fader
- ⑫ **CD•C** button, switches sound source between tape, radio and CD changer (if connected)
- ⑬ **AUDIO** button, adjusts bass and treble
LD button, switches the loudness function on/off
- ⑭ Cursor block
- ⑮ **MENU** button, accesses the menus for making basic settings
- ⑯ **1 to 5** station buttons
- ⑰ **🕒** button, indicates the time in the display

Important information	6	CD changer operation	12
Traffic safety	6	Starting CD changer operation	12
Installation	6	Selecting CDs	12
Accessories	6	Selecting tracks	12
Guarantee	6	Switching the display mode	12
International telephone information ...	6	Repeating individual tracks or entire CDs (REPEAT)	13
Theft protection system	7	Playing tracks in random order (MIX)	13
Removable front panel	7	Scanning all of the tracks on all of the CDs (SCAN)	13
Switching the car audio system on/off	8	Adjusting the scan time	13
Volume control	8	Interrupting playback (PAUSE)	14
Adjusting the power-on volume	8	Clock	14
Mute	9	Time display	14
Telephone mute	9	Setting the time	14
Radio operation	9	Selecting the 12/24-hour time display mode	14
Switching to the radio mode	9	Activating the clock display for the car audio system when it is switched off	15
Selecting wavebands/memory banks	9	Adjusting the tone	15
Tuning into radio stations	9	Adjusting the bass	15
Adjusting seek tuning sensitivity	10	Adjusting the treble	15
Storing radio stations	10	Switching Loudness on/off	15
Storing radio stations automatically (TravelStore)	10	Adjusting the volume distribution	16
Recalling stored radio stations	10	Adjusting the balance	16
HICUT (interference-related treble cut)	10	Adjusting the fader	16
Tuner switchover	11	External audio sources	16
Tape operation	11	Switching the AUX output on/off ...	16
Tape playback	11	Specifications	17
Switching tape sides	11	Amplifier	17
Fast tape forward/rewind	11	Tuner	17
Switching the Radio Monitor on/off:	12	Tape	17
Tape eject	12		

IMPORTANT INFORMATION

Important information

Before you use your car audio system for the first time, please take the time to read the instruction manual carefully and make yourself familiar with the audio equipment. Keep this manual handy in your car for future reference.

Traffic safety

 Traffic safety is always the top priority. Do not operate your car audio system unless the traffic conditions permit. Familiarize yourself with the equipment before you start driving.

Always make sure that you are still able to hear any warning signals coming from outside the vehicle, such as police or fire engine sirens, at all times. Consequently, you should always select a moderate volume for playing your car audio system while you are driving.

Installation

If you would like to install your new car stereo yourself or add other audio components to the existing ones, then please read the instructions on installation and connection at the end of this manual carefully.

Accessories

Use only Blaupunkt-approved accessories.

Remote control unit

The optionally available RC 08 infrared remote control unit allows you to conveniently operate the most important system functions from the steering wheel.

Amplifiers

All Blaupunkt amplifiers can be used.

CD changers

The following CD changers can be connected directly: CDC A 06, CDC A 08, CDC A 072 and IDC A 09.

The CDC A 05 and CDC A 071 can be connected with an adapter cable (Blaupunkt no. 7 607 889 093).

Guarantee

The scope of the guarantee is determined by the laws in the country where the unit is purchased.

Regardless of the legal guarantee regulations, Blaupunkt affords a 12-month guarantee.

If you have any questions about the guarantee, please contact your authorized Blaupunkt dealer. Your cash register receipt is a valid guarantee coupon.

International telephone information

Have you got any questions on the operation of this equipment or do you require more information?

Give us a call!

You will find the international telephone and fax numbers on the last page of this manual.

Theft protection system

Removable front panel

To prevent your car audio system from being stolen, it has been equipped with a removable front panel (release panel). Without the front panel, the car audio system is useless to thieves.

Protect your car audio system against theft and take the operating panel with you each time you leave the vehicle. Never leave the release panel in the car, even when it is well hidden. The panel has been designed so that it is easy to remove.

Notes:

- Do not drop the release panel.
- Do not expose the release panel to direct sunlight or other heat sources.
- Protect the panel from exposure to moisture.
- Store the release panel in the case supplied.
- If the car audio system was on when you removed the panel, it will automatically switch back on using the same settings when you replace it (radio, tape or CD changer).

Removing the operating panel

⇨ Press **[V]** ①.

The release panel will unlock.

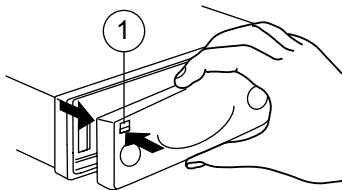

- ⇨ First pull the operating panel forward and then slide it to the left to remove it.
- When you remove the operating panel, the car audio system will automatically switch off.
- All of the settings will remain stored.
- A tape inserted into the car audio system will remain in place.

Replacing the operating panel

- ⇨ Slide the operating panel into the guides from left to right.
- ⇨ Press the left-hand side of the panel onto the car audio system until it locks into place.

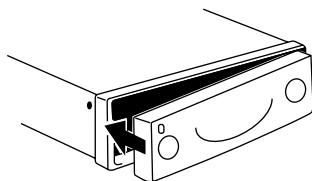

Note:

- While replacing the panel, be careful not to press on the display.

Switching the car audio system on/off

The car audio system can be switched on/off in a number of ways.

- Switching the car audio system on/off with the vehicle ignition.

If the car audio system has been connected to your vehicle ignition, it is possible to switch it on and off with the ignition.

You can also switch the car audio system on when the ignition is switched off.

- ⇒ Press down and hold (4) until the car audio system switches on.

Note:

To prevent the car battery from running down, the radio will switch off again automatically after one hour.

- Switching the car audio system on/off with the removable front panel

- ⇒ Remove the release panel.

The car audio system will switch off.

- ⇒ Replace the release panel.

The car audio system will switch on again. The last settings used (radio, tape or CD changer) will be activated.

- Switching the car audio system on/off by pressing (4).

- ⇒ Press (4) to switch the car audio system on.

- ⇒ Press (4) for longer than 2 seconds to switch the car audio system off again.

Volume control

The car audio system volume can be adjusted to levels from 0 (off) to 66 (maximum).

- ⇒ To increase the volume, turn the volume control knob (3) to the right.

- ⇒ To decrease the volume, turn the volume control knob (3) to the left.

Adjusting the power-on volume

It is possible to adjust the volume at which the car audio system switches on.

- ⇒ Press **MENU** (15).

- ⇒ Press **V** (14).

“ON VOLUME” will appear in the display.

- ⇒ Press **<>** (14) to adjust the volume.

To make it easier to select the desired volume, you will be able to hear any changes made while you are adjusting the volume.

If you adjust this setting to 0, the car audio system will switch on at the volume used before it was switched off.

 **Warning of serious injury**
When the power-on volume is set to the maximum level, it may be extremely loud when the car audio system is switched on.

When the power-on volume is set to 0 and the car audio system was played at maximum volume before it was switched off, it may be extremely loud when the car audio system is switched back on. This could result in serious injury to your ears.

- ⇨ Once you have selected the desired settings, press **MENU** (15).

Mute

You can reduce the volume of the car audio system immediately (mute).

- ⇨ Press (4).

Selecting the mute level

It is possible to select the mute level.

- ⇨ Press **MENU** (15).
- ⇨ Press **Y** (14) repeatedly until "MUTE LEVEL" appears in the display.
- ⇨ Press **<>** (14) to select the mute level.
- ⇨ Once you have made your selection, press **MENU** (15).

Telephone mute

If your car audio system has been equipped with a mobile telephone, it will automatically switch to mute when you use the phone. This will not work unless the mobile phone is connected to the car audio system as described in the installation instructions.

The car audio system will be muted to the mute level selected.

Radio operation

Switching to the radio mode

If you are currently using the tape player or CD changer,

- ⇨ press **CD•C** (12) repeatedly until "RADIO" appears in the display.

Selecting wavebands/memory banks

Using this car audio system, you can tune into radio stations on the FM and AM wavebands. There are three memory banks for the FM waveband and one memory bank for AM. You can store five stations in each of these memory banks.

Selecting FM

- ⇨ To switch between the FM wavebands FM1, FM2 and FMT, press **FM** (2).

Selecting AM

- ⇨ To switch between the AM waveband, press **AM** (6).

Tuning into radio stations

You can tune into radio stations in a number of different ways.

Automatic seek tuning

- ⇨ Press **Y** or **▲** (14).

The radio will tune into the next available station within reception range.

RADIO OPERATION

Adjusting seek tuning sensitivity

It is also possible to adjust the sensitivity of the seek tuning function. In this way you can adjust the radio to tune into stations with strong reception signals only, or to those with weaker reception signals as well.

- ⇨ Press **MENU** (15).
- ⇨ Press **Y** (14) repeatedly until "SENS" appears in the display.
- ⇨ Press **>** (14).

The currently selected setting will appear in the display. "SENS HI" indicates the highest level of sensitivity, "SENS LO" the lowest. If you select "SENS LO", "lo" will light up in the display.

- ⇨ Press **<>** (14) to adjust the desired sensitivity.
- ⇨ Once you have made your selection, press **MENU** (15).

Manual station tuning

You can also tune into radio stations manually.

- ⇨ Press **<** or **>** (14).

Storing radio stations

Storing radio stations manually

- ⇨ Select the desired FM memory bank FM1, FM2, FMT or the AM waveband.
- ⇨ Tune into the radio station you would like to store.

- ⇨ Press and hold down one of the station preset buttons **1** to **5** (16) on which you want to store the radio station for longer than one second.

Storing radio stations automatically (TravelStore)

You can automatically store the five radio stations with the strongest reception in the area. These stations will be stored in the FMT or AM memory bank, depending on which waveband you have selected.

Note:

Any stations stored previously in the memory bank will be deleted.

- ⇨ Press **TS** (5) briefly.

The storing process will begin. "T-STORE" will appear in the display. After the stations have been stored, the radio will automatically begin to play the station stored on preset button 1 for the corresponding memory bank.

Recalling stored radio stations

- ⇨ Select the desired station memory bank.
- ⇨ Press the station button **1** to **5** (16) on which you have stored the desired radio station.

HICUT (interference-related treble cut)

The HICUT function improves reception when reception begins to deteriorate. If interference occurs, the treble, and consequently the noise level, is cut automatically.

Switching HICUT on/off

⇨ Press **MENU** (15).

“MENU” will appear in the display.

⇨ Press **Y** (14) repeatedly until “HICUT” appears in the display.

⇨ Press **<** or **>** (14) to switch HICUT on or off.

“HICUT 0” indicates that the function is switched off; when “HICUT 1” appears, the treble and the noise level will be cut.

⇨ Press **MENU** (15).

Tuner switchover

The car audio system has been equipped with a multi-band tuner. The tuner can be adjusted to accommodate different requirements in different countries. The following regions can be selected: America, Europe, Asia and Thailand. The tuner will not be completely functional until it has been adjusted to the country in which it is being used.

Switching over the tuner

⇨ Press **MENU** (15).

⇨ Press **Y** (14) repeatedly until “FM TUNER” appears in the display.

⇨ Press **<>** (14) to select the country.

⇨ Once you have made your selection, press **MENU** (15).

Tape operation

Tape playback

- If there is no tape in the car audio system

⇨ insert a tape into the tape deck with the open side facing to the right.

Tape playback will begin with the side facing upwards. A tape symbol will light up in the display.

- If there is a tape in the car audio system

⇨ press **CD•C** (12) repeatedly until “TAPE” appears in the display.

The tape will begin to playback from the side last selected.

Switching tape sides

⇨ Press **FR** (9) and **FF** (10) at the same time.

The tape will switch sides. Once the tape reaches the end, it will automatically switch to the other side (Autoreverse).

Fast tape forward/rewind

Fast forward

⇨ Press **FF** (10) (fast forward) until the button locks into place.

“FORWARD” will appear in the display.

Fast rewind

⇨ Press **FR** (9) (fast rewind) until the button locks into place.

“REWIND” will appear in the display.

TAPE OPERATION

Stopping fast forward/rewind

- ⇨ Press the button for the opposite direction.

Playback will resume.

Switching the Radio Monitor on/off:

While the tape is fast forwarding or re-winding, you can listen to the radio station you were tuned into last. To do this you have to switch on the "Radio Monitor".

- ⇨ Press **MENU** (15).

"MENU" will appear in the display.

- ⇨ Press **Y** (14) repeatedly until "RM ON" or "RM OFF" appears in the display.

- ⇨ Press **<** or **>** (14) to switch the radio monitor on or off.

- ⇨ Press **MENU** (15).

Tape eject

- ⇨ Press **⏏** (7).

Remove the tape from the car audio system.

CD CHANGER OPERATION

CD changer operation

Note:

Refer to the instructions included with the CD changer for more information on how to handle CDs, how to insert CDs into the changer and how to operate the changer.

Starting CD changer operation

- ⇨ Press **CD•C** (12) repeatedly until "CHANGER" appears in the display.

Playback will begin with the first CD the changer detects in the magazine.

Selecting CDs

- ⇨ To select a different CD up or down, press **▲** or **▼** (14) once or the required number of times.

Selecting tracks

- ⇨ To select a different track up or down on the CD currently playing, press **▶** or **<** (14) once or the required number of times.

Switching the display mode

To switch the display between the CD number and the elapsed playing time,

- ⇨ press **MENU** (15).

"MENU" will appear in the display.

- ⇨ Press **Y** (14) repeatedly until "CDC DISP" appears in the display.

- ⇨ Press **▶** (14).

The current setting will be shown in the display. "TIME" stands for elapsed playing time and "CD NO" for the display of the CD number.

- ⇨ Press **◀** (14) to select the desired setting.
- ⇨ Press **MENU** (15).

Repeating individual tracks or entire CDs (REPEAT)

- ⇨ To repeat the track currently playing, press **3 (RPT)** (16) briefly. "RPT TRCK" will appear briefly in the display, RPT will light up in the display.
- ⇨ To repeat the entire CD currently playing, press **3 (RPT)** (16) again. "RPT DISC" will appear briefly in the display, RPT will light up in the display.

Stopping the REPEAT function

- ⇨ To stop the REPEAT function for the current track or CD, press **3 (RPT)** (16) repeatedly until "RPT OFF" appears in the display and RPT no longer lights up.

Playing tracks in random order (MIX)

- ⇨ To play the tracks of the currently selected CD in random order, press **4 (MIX)** (16) briefly. "MIX-CD" will appear briefly in the display, MIX will light up in the display.
- ⇨ To play the tracks of all of the CDs in random order, press **4 (MIX)** (16) again. "MIX ALL" will appear briefly in the display, MIX will light up in the display.

Note:

The CDC A 08 is able to play all of the CDs in the changer in random order. The other CD changers first play all of the tracks on a CD in random order and then select the next CD in the changer.

Stopping the MIX function

- ⇨ To stop the MIX function, press **4 (MIX)** (16) repeatedly until "MIX OFF" appears in the display and MIX no longer lights up.

Scanning all of the tracks on all of the CDs (SCAN)

- ⇨ To scan all of the tracks on all of the CDs in ascending order, press **5 (SCAN)** (16). "SCAN" will appear in the display.

Stopping the SCAN function

- ⇨ To stop the SCAN function, press **5 (SCAN)** (16) again briefly.

The track currently scanned will continue playing.

Note:

It is possible to adjust the scan time.

Adjusting the scan time

- ⇨ Press **MENU** (15). "MENU" will appear in the display.
- ⇨ Press **▼** (14) repeatedly until "SCANTIME" appears in the display.
- ⇨ Press **◀ ▶** (14) to set the scan time as desired.
- ⇨ Once you have made your selection, press **MENU** (15).

Interrupting playback (PAUSE)

⇨ Press **2** (▶) (16).

“PAUSE” will appear in the display.

Stopping PAUSE

⇨ Press **2** (▶) (16) during the pause.

Playback will resume.

CLOCKTime display

⇨ To display the time briefly, press **CLOCK** (17) briefly.

Setting the time

⇨ To set the time, press **MENU** (15).

⇨ Press **Y** (14) repeatedly until “CLOCKSET” appears in the display.

⇨ Press **➤** (14).

The time will appear in the display. The minutes will flash and can be altered.

⇨ Press **▲ Y** (14) to alter the minutes.

⇨ Once you have altered the minutes, press **◀** (14). The hours will begin to flash.

⇨ Press **▲ Y** (14) to alter the hours.

⇨ Once you have set the time, press **MENU** (15).

Selecting the 12/24-hour time display mode

⇨ Press **MENU** (15).

“MENU” will appear in the display.

⇨ Press **Y** (14) repeatedly until “24 H MODE” or “12 H MODE” appears in the display.

⇨ Press **◀** or **➤** (14) to switch the display mode.

⇨ Once you have selected the mode, press **MENU** (15).

Activating the clock display for the car audio system when it is switched off

- ⇒ To activate the clock display for the car audio system when it is switched off, press **MENU** (15).
- “MENU” will appear in the display.
- ⇒ Press **Y** (14) repeatedly until “CLOCK OFF” or “CLOCK ON” appears in the display.
- ⇒ Press **◀** or **▶** (14) to switch the clock display on or off.
- ⇒ Once you have made the setting, press **MENU** (15).

Adjusting the tone

Adjusting the bass

- ⇒ To adjust the bass, press **AUDIO** (13).
- “BASS” will appear in the display.
- ⇒ Press **▲** or **▼** (14) to alter the bass.

Adjusting the treble

- ⇒ To adjust the treble, press **AUDIO** (13).
- “BASS” will appear in the display.
- ⇒ Press **AUDIO** (13) again.
- “TREBLE” will appear in the display.
- ⇒ Press **▲** or **▼** (14) to alter the treble.

Switching Loudness on/off

Loudness boosts the bass and treble when the volume is low to create a more natural sound.

- ⇒ Press **AUDIO** (13) for approx. two seconds.
- LD will light up in the display when Loudness is active.

Adjusting Loudness intensity

The Loudness boost can be set in stages from one to six.

- ⇒ Press **MENU** (15).
- ⇒ Press **Y** (14) repeatedly until “LOUDNESS” appears in the display.
- ⇒ Press **◀** or **▶** (14) to alter the Loudness setting.
- ⇒ Once you have completed adjusting the settings, press **MENU** (15).

Adjusting the volume distribution

Adjusting the balance

- ⇒ To adjust the balance, press **GEO** (11).

“BAL” will appear in the display.

- ⇒ Press **▲** or **▼** (14) to alter the balance between the left and right speakers.

Adjusting the fader

- ⇒ To adjust the fader, press **GEO** (11).

“BAL” will appear in the display.

- ⇒ Press **GEO** (11) again.

“FADER” will appear in the display.

- ⇒ Press **▲** or **▼** (14) to alter the fader for the front and rear speakers.

External audio sources

In place of the CD changer it is also possible to connect other external audio sources to the line output. These sources can include a portable CD player, MiniDisc player or MP3 player.

If you would like to connect another external audio source, you will require a Blaupunkt adapter cable with the Blaupunkt no.: 7 607 897 093.

You must activate the AUX output in the menu.

Switching the AUX output on/off

- ⇒ Press **MENU** (15).

“MENU” will appear in the display.

- ⇒ Press **▼** (14) repeatedly until “AUX OFF” or “AUX ON” appears in the display.

- ⇒ Press **<** or **>** (14) to switch AUX on or off.

- ⇒ Once you have completed your selections, press **MENU** (15).

Note:

You can then press **CD•C** (12) to select the AUX output.

Specifications

Amplifier

Output power: 4 x 25 watts sinus
acc. to DIN 45
324 at 14.4 V
4 x 40 watts max.
power

Tuner

Wavebands:

FM : 87.5 – 108 MHz

AM : 531 – 1602 kHz

FM frequency response:

20 - 16 000 Hz

Tape

Frequency response:

30 - 18 000 Hz

Subject to technical modification!

Service numbers / Numéros du service après-vente / Números de servicio / Número de serviço

	Tel.:	Fax:
Deutschland	0 18 05 00 02 25	0 51 21 49 40 02
Belgique / België	0 25 25 54 44	0 25 25 54 48
France	014 010 70 07	014 010 73 20
Nederland	023 565 63 48	023 565 63 31
Great Britain	018 958 383 66	018 958 383 94
Danmark	44 89 83 60	44 89 86 44
Sverige	08 750 15 00	08 750 18 10
Norge	66 81 70 00	66 81 71 57
Suomi	094 359 91	094 359 92 36
Österreich	01-6 10 39-0	01-6 10 39-391
Ελλάς	015 762 241	015 769 473
Česká republika	026 130 04 41	026 130 05 14
USA	800-266 25 28	708-681 71 88
Singapore	006 535 054 47	006 535 053 12
Slovensko	042 175 873 212	042 175 873 229

Blaupunkt-Werke GmbH
Bosch Gruppe



Radio / Cassette

Hollywood C30 Melbourne C30

Installation instructions
Notice de montage
Instrucciones de instalación
Instrução de montagem



 **BLAUPUNKT**

Installation instructions • Notice de montage • Instrucciones de instalación • Instruções de montagem

Safety instructions

When carrying out installation work and making connections please observe the following safety instructions:

- Disconnect the negative terminal of the battery! When doing so, please observe the vehicle manufacturer's safety instructions.
- Make sure you do not damage vehicle components when drilling any holes.
- The cross sections of the positive and negative cables must not be less than 1.5 mm².
- Incorrect installation may cause interference with electronic vehicle systems or your car radio.
- Do **not** connect the vehicle's plug connectors to the radio!
- You can obtain the adapter cable required for your vehicle type from any BLAUPUNKT dealer.

Consignes de sécurité

Respecter les consignes de sécurité suivantes pendant la durée du montage et du branchement.

- Débrancher le pôle (-) de la batterie ! Respecter les consignes de sécurité du constructeur automobile !
- Veiller à n'endommager aucune pièce du véhicule en perçant des trous.

- La section du câble (+) et (-) ne doit pas dépasser 1,5 mm².
- En cas d'erreur d'installation, des perturbations peuvent survenir dans les systèmes électroniques du véhicule ou dans votre autoradio.
- **Ne pas** brancher les connecteurs du véhicule sur la radio !
- Les câbles d'adaptation nécessaires pour le type de véhicule sont disponibles auprès des revendeurs BLAUPUNKT.

Normas de seguridad

Durante el montaje y la conexión es imprescindible observar las siguientes normas de seguridad.

- Desemborne el polo negativo de la batería.
Observe las normas de seguridad dadas por el fabricante del vehículo.
- Al perforar agujeros, asegúrese de no dañar ninguna pieza del vehículo.
- La sección transversal del cable positivo y del cable negativo no debe ser menor de 1,5 mm².
- Una instalación incorrecta puede provocar perturbaciones en los sistemas electrónicos del vehículo o en la radio.
- ¡**No** conecte a la radio los conectores ubicados en el vehículo!

- Los cables adaptadores necesarios para su vehículo los encontrará en el comercio especializado en artículos de la marca BLAUPUNKT.

(P) ⚠ Instruções de segurança

Durante a montagem e a ligação do aparelho, queira respeitar as seguintes instruções de segurança.

- Separar o pólo negativo da bateria ! Respeitar ao mesmo tempo as instruções de segurança do fabricante do automóvel.
- Quando se procede à furagem de buracos, prestar atenção para não serem danificadas quaisquer partes do veículo.
- As secções transversais dos cabos positivo e negativo não devem ser inferiores a 1,5 mm².
- Se a montagem for executada de forma incorrecta podem ocorrer avarias nos sistemas electrónicos do automóvel ou no seu auto-rádio.
- **Não** ligar as fichas existentes do lado do automóvel ao auto-rádio!
- Os cabos adaptadores necessários para o seu automóvel podem ser adquiridos nos revendedores da BLAUPUNKT.

Supplied Mounting Hardware

Materiel de montage fourni

Ferreteria de montaje suministrada

Medföljande monteringsdetaljer

Elementos de fixação fornecidos.

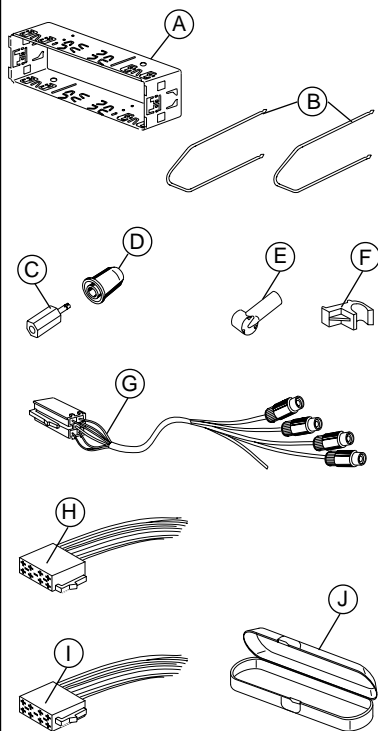

1.

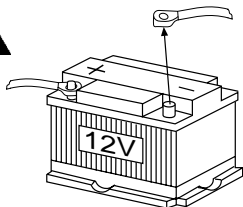

2.

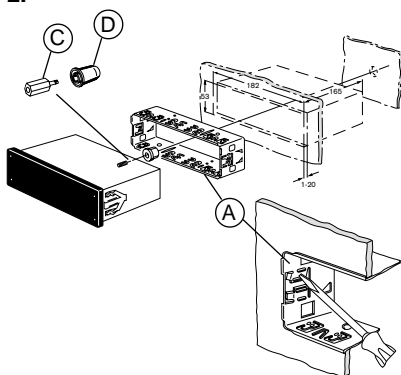

3.

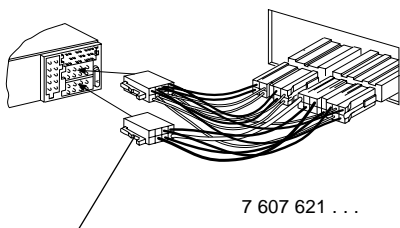

Car-specific adapter cable which is available at your dealer.

Câble adaptateur spécifique au véhicule, disponible dans le commerce.

Adaptador específico del vehículo, el cual se puede adquirir en el comercio especializado.

Cabo de adaptação específico do automóvel que pode ser adquirido no comércio especializado.

4.

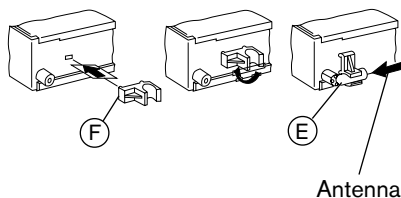

5.

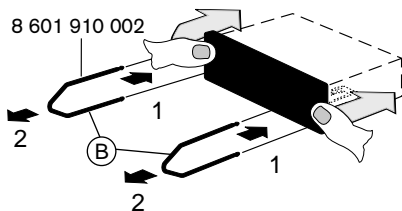

6.

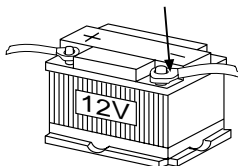

7.

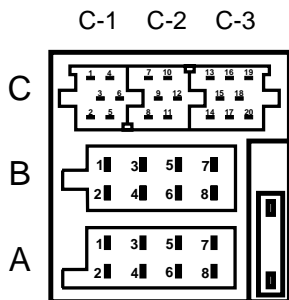

A		B	
1	nc	1	Speaker out RR+
2	Telefon Mute	2	Speaker out RR-
3	nc	3	Speaker out RF+
4	Permanent +12V	4	Speaker out RF-
5	Aut. antenna	5	Speaker out LF+
6	Illumination	6	Speaker out LF-
7	Kl.15/Ignition	7	Speaker out LR+
8	GND	8	Speaker out LR-

C					
C1		C2		C3	
1	Line Out LR	7	nc	13	Bus - In
2	Line Out RR	8	nc	14	Bus - Out
3	Line Out GND	9	nc	15	Permanent +12V
4	Line Out LF	10	RC +12V	16	+12V
5	Line Out RF	11	Remote Control	17	Bus - GND
6	+12V Amplifier	12	RC - GND	18	AF - GND
				19	Line In - L
				20	Line In - R

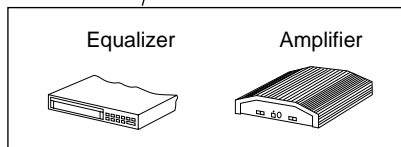

Remote Control



CD-Changer

8.

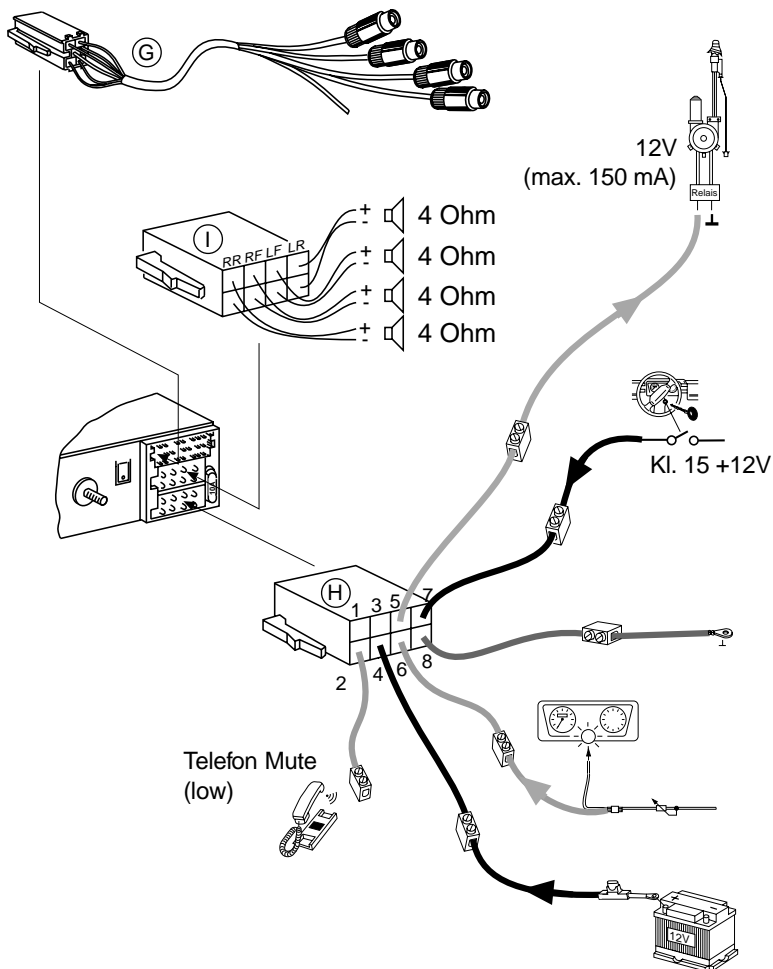

This information is subject to change without notice!

Sous réserve de modifications!

Modificaciones reservadas!

Sob reserva de alterações!