

Radio / CD

Miami Beach CD51 Tampa Bay CD51

Operating instructions



 **BLAUPUNKT**

Open here
Ouvrir s.v.p.
Por favor, abrir
Favor abrir

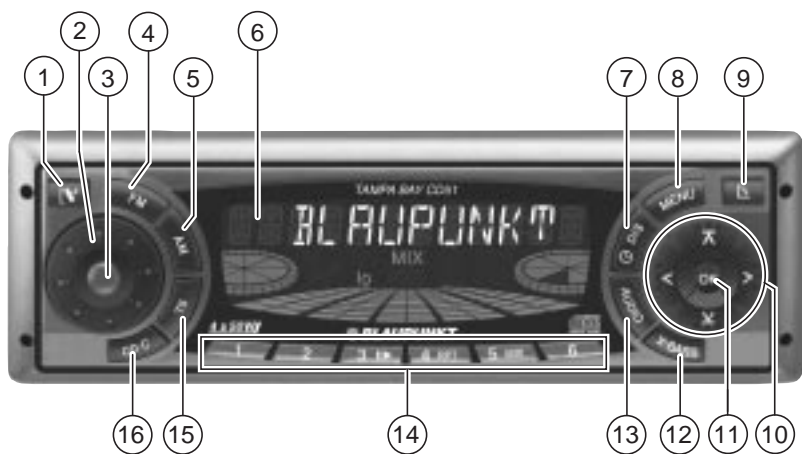

CONTROLS

- ① **🔒** button – to unlock the removable control panel (release panel)
- ② Volume control
- ③ Button – switches the unit on/off, volume mute
- ④ **FM** button – selects the radio mode source, selects the FM memory levels
- ⑤ **AM** button – selects the radio mode source, selects the AM frequency range
- ⑥ Display
- ⑦ **🕒** button – displays the time, **DIS** – changes the display content
- ⑧ **MENU** button – opens the basic settings menu
- ⑨ **🔓** button – opens the flip-release panel
- ⑩ Arrow buttons
- ⑪ **OK** button – confirms menu entries and starts the scan function
- ⑫ **X-BASS** button – to set the X-Bass feature
- ⑬ **AUDIO** button (audio) – adjusts the bass, treble, balance and fader
- ⑭ Keys **1 - 6**
- ⑮ **TS** button – starts the Travel-store function
- ⑯ **CD•C** button – to switch between CD, CD changer (if connected) and AUX sources

Notes and accessories	6	Scanning tracks (SCAN)	14
Road safety	6	Repeating tracks (REPEAT)	14
Installation	6	Pausing playback (PAUSE)	14
Accessories	6	Changing the display	15
International telephone information ...	6	Ejecting a CD	15
Removable control panel	7	CD changer mode	15
Switching on/off	8	Switching to CD changer mode	15
Adjusting the volume	9	Selecting a CD	15
Setting the power-on volume	9	Selecting tracks	15
Instantaneous volume reduction		Quick track selection	15
(mute)	9	Fast searching (audible)	15
Telephone audio / navigation audio ..	9	Changing the display	16
Setting the volume of the		Repeating individual tracks or	
confirmation beep	10	whole CDs (REPEAT)	16
Radio mode	11	Random play (MIX)	16
Switching to radio mode	11	Scanning all tracks on all CDs	
Selecting the frequency range /		(SCAN)	16
memory	11	Pausing playback (PAUSE)	17
Tuning into a station	11	CLOCK - Time	17
Storing stations	11	Sound and	
Storing stations automatically		volume distribution settings ..	19
(Travelstore)	12	Adjusting the bass settings	19
Listening to preset stations	12	Adjusting the treble settings	19
Scanning receivable stations		Setting the left/right volume	
(SCAN)	12	distribution (balance)	19
Setting the scantime	12	Setting the front/back volume	
Tuner configuration	12	distribution (fader)	19
Setting the display	13	X-BASS	20
CD mode	13	Setting the spectrometer	20
Switching to CD mode	13	External audio sources	21
Selecting tracks	14	Specifications	21
Quick track selection	14	Guarantee	22
Fast searching (audible)	14	Installation instructions	80
Random play (MIX)	14		

NOTES AND ACCESSORIES

Thank you for deciding to purchase a Blaupunkt product. We hope you enjoy using this new piece of equipment.

Before using the device for the first time, please read these instructions carefully. The Blaupunkt editors are constantly working on making the operating instructions clearer and easier to understand. However, if you still have any questions on how to operate the unit please contact your dealer or the telephone hotline for your country. You will find the hotline telephone numbers printed at the back of this booklet.

Road safety

 Road safety has absolute priority. Only operate your car radio if the road and traffic conditions allow you to do so. Familiarise yourself with the unit before setting off on your journey.

You should always be able to hear police, fire and ambulance sirens from afar. For this reason, set the volume of whatever you are listening to to a reasonable level.

Installation

If you want to install your car radio yourself, please read the installation and connection instructions that follow these operating instructions.

Accessories

Only use accessories approved by Blaupunkt.

Remote control

The optional RC08 or RC10 remote controls allow you to safely and conveniently access the most important functions of your car radio from your steering wheel.

The RC 06 H remote control is supplied with the Tampa Bay CD51.

Amplifier

All Blaupunkt amplifiers can be used.

CD changer

You can connect the following Blaupunkt CD changers:

CDC A 06, CDC A 08, CDC A 072 and IDC A 09.

You can also connect the CDC A 05 and CDC A 071 CD changers by using an adapter cable (Blaupunkt no.: 7 607 889 093).

International telephone information

If you have any questions regarding the operation of your car radio or if you require further information, please do not hesitate to call us!

The information hotline numbers are printed on the last page of these instructions.

Removable control panel

Theft protection

As a way of protecting your car radio against theft, the unit is equipped with a removable control panel (flip-release panel). Without this control panel, the car radio is worthless to a thief.

Protect your car radio against theft by taking the control panel with you every time you leave your vehicle. Do not leave the control panel in your vehicle - not even in a hiding place.

The control panel has been designed to be easy to use.

Note:

- Never drop the control panel.
- Never expose the control panel to direct sunlight or other heat sources.
- Store the control panel in the supplied case.
- Avoid making direct skin contact with the control panel's contacts. If necessary, clean the contacts with a lint-free cloth soaked in cleaning spirits.

Removing the control panel

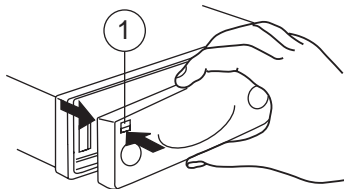

- ⇒ Press the **[V]** button ①.

The control panel locking mechanism opens.

- ⇒ First, pull the control panel straight off the unit and then out towards the left.
- The unit switches off after the control panel is removed.
- All the current settings are saved.
- Any CD already inserted in the unit remains there.

Attaching the control panel

- ⇒ Slide the control panel from left to right into the unit's panel locking mechanism.
- ⇒ Press the left-hand edge of the control panel into the unit until it clicks into place.

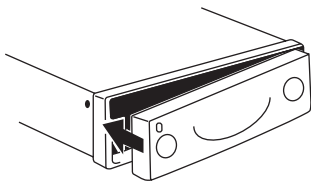

Note:

- When attaching the control panel, make sure you do not press the display.

If the unit was still switched on when you removed the control panel, the unit will automatically switch on with the last settings activated (i.e. radio, CD, CD changer, or AUX) when the panel is replaced.

SWITCHING ON/OFF

Switching on/off

There are various ways of switching the unit on/off:

Switching on/off using the vehicle ignition

If the unit is correctly connected to the vehicle's ignition and it was not switched off using button ③, it will switch on/off simultaneously with the ignition.

You can switch the unit on even if the ignition is off:

- ⇨ To do so, press button ③.

Note:

- To protect the vehicle battery, the unit will switch off automatically after one hour if the ignition is off.

Switching on/off using the removable control panel

- ⇨ Remove the control panel.

The unit switches off.

- ⇨ Attach the control panel again.

The unit switches on. The last settings (radio, CD, CD changer or AUX) will be reactivated.

Switching on/off using button ③

- ⇨ To switch the unit on, press button ③.

- ⇨ To switch the unit off, press button ③ for longer than two seconds.

The unit switches off.

Switching on by inserting a CD

If the unit is switched off and there is no CD inserted in the drive,

- ⇨ press the  button ⑨.

The flip-release panel opens.

- ⇨ Gently insert the CD with the printed side uppermost into the drive until you feel some resistance.

The CD will be drawn automatically into the drive.

You must not hinder or assist the drive as it draws in the CD.

- ⇨ Gently close the control panel whilst exerting a little pressure until you feel it click into place.

The unit switches on. CD playback begins.

ADJUSTING THE VOLUME

Adjusting the volume

The volume can be adjusted in steps from 0 (off) to 66 (maximum).

- ⇒ To increase the volume, turn the volume control (2) to the right.
- ⇒ To decrease the volume, turn the volume control (2) to the left.

Setting the power-on volume

You can set the unit's default power-on volume.

- ⇒ Press the **MENU** button (8).
- ⇒ Keep pressing the **V** or **A** button (10) until "ON VOLUME" appears in the display.
- ⇒ Set the power-on volume using the **<** and **>** buttons (10).

If you change the setting to "0", the power-on volume will be the same as the volume level that was set before the unit was last switched off.

Note:

- To protect your hearing, the power-on volume is limited to a value of "38". If the volume level was higher when the unit was switched off, the volume will be reset to "38" when the unit is switched on again.

When you have finished making your changes,

- ⇒ press the **MENU** button (8) or **OK** (11) twice.

Instantaneous volume reduction (mute)

This feature allows you to instantaneously reduce (mute) the volume to a level preset by you.

- ⇒ Briefly press button (3).
- "MUTE" appears in the display.

Setting the mute level

You can set the unit's mute volume level.

- ⇒ Press the **MENU** button (8).
- ⇒ Keep pressing the **V** or **A** button (10) until "MUTE LEVEL" appears in the display.
- ⇒ Set the mute level using the **<** and **>** buttons (10).

When you have finished making your changes,

- ⇒ press the **MENU** button (8) or **OK** (11) twice.

Telephone audio / navigation audio

If your car radio is connected to a mobile telephone or a navigation system, the unit's volume will be muted as soon as you "pick up" the telephone or as soon as a navigation announcement is made. The caller or voice output will then be heard over the car radio loudspeakers. In order for this to work, the mobile telephone or navigation system must be connected to the car radio in the manner described in the installation instructions.

ADJUSTING THE VOLUME

You can find out from your Blaupunkt dealer which navigation systems can be used with your car radio.

You can set the volume level at which telephone calls and the navigation voice output will first be heard.

- ⇒ Press the **MENU** button (8).
- ⇒ Keep pressing the **↵** or **↶** button (10) until "TEL/NAVI VOL" appears in the display.
- ⇒ Set the required volume using the **<** and **>** buttons (10).

When you have finished making your changes,

- ⇒ press the **MENU** button (8) or **OK** (11) twice.

Note:

- Using the volume control (2), you can directly adjust the volume of telephone calls and navigation voice output (whilst they are being heard).

Setting the volume of the confirmation beep

For some functions you will hear a confirmation beep if you keep a button pressed for longer than two seconds. For instance, after storing a radio station to a station button you will hear a confirmation beep. You can set the volume of this beep.

- ⇒ Press the **MENU** button (8).
- ⇒ Keep pressing the **↵** or **↶** button (10) until "BEEP" appears in the display.

- ⇒ Set the volume using the **<** and **>** buttons (10). "0" means beep off, "9" means maximum beep volume.

When you have finished making your changes,

- ⇒ press the **MENU** button (8) or **OK** (11).

Radio mode

Switching to radio mode

If you are in CD, CD changer or AUX mode,

⇒ press the **FM** (4) / **AM** (5) button

or

⇒ keep pressing the **CD•C** button (16) until "RADIO" appears in the display.

Selecting the frequency range / memory

This unit can receive programmes broadcast over the FM and AM frequency ranges. There are three preset memory levels for the FM range and one for the AM range. Six stations can be stored on each memory level.

Selecting the FM memory level

⇒ Press the **FM** button (4) to switch between the FM memory levels (FM1, FM2 and FMT).

Selecting the AM frequency range

⇒ Press the **AM** button (5) to select the AM frequency range.

Tuning into a station

There are various ways of tuning into a station.

Automatic seek tuning

⇒ Press the **↵** or **↶** button (10).

The unit tunes into the next receivable station.

Setting the sensitivity for station seek tuning

You can configure the radio to only tune into stations with a strong reception or to also tune into those with a weak reception.

⇒ Press the **MENU** button (8).

⇒ Keep pressing the **↵** or **↶** button (10) until "SENS HI" or "SENS LO" appears in the display.

"SENS HI" means that the tuner is highly sensitive. "SENS LO" means it is set to the lowest sensitivity setting. If "SENS LO" is selected, "lo" lights up in the display.

⇒ Set the required sensitivity using the **<** and **>** buttons (10).

When you have finished making your changes,

⇒ press the **MENU** button (8) or **OK** (11).

Tuning into stations manually

You can also tune into stations manually.

⇒ Press the **<** or **>** button (10).

Storing stations

Storing stations manually

⇒ Select the required memory level (FM1, FM2 or FMT) or the AM frequency range.

⇒ Tune into the station.

⇒ Press one of the station buttons **1-6** (14) for longer than one second to store the station to that button.

RADIO MODE

Storing stations automatically (Travelstore)

You can automatically store the six stations with the strongest reception in the region. The stations are stored in the FMT or AM memory depending on the selected frequency range.

Note:

- Stations that were previously stored in this memory are deleted in the process.

⇒ Briefly press the **TS** button (15).

The station storing procedure begins. "TRAVEL-STORE" appears in the display. After the process is completed, the station that is stored in location 1 of the respective memory level will be played.

Listening to preset stations

- ⇒ Select the memory level on which the station was stored.
- ⇒ Press the preset station button **1-6** (14) of the station you want to listen to.

Scanning receivable stations (SCAN)

You can briefly play all the receivable stations. You can set the scanning time to between 5 and 30 seconds in the menu.

Starting SCAN

- ⇒ Keep the **OK** button (11) pressed until the scan process starts.

"SCAN" appears briefly in the display followed by the current frequency (which flashes).

Stopping SCAN and continuing listening to a station

- ⇒ Press the **OK** button (11).

Scanning is stopped and the station that was tuned into last will remain active.

Setting the scantime

- ⇒ Press the **MENU** button (8).
- ⇒ Keep pressing the **∨** or **∧** button (10) until "SCANTIME" appears in the display.
- ⇒ Set the required scantime using the **<** and **>** buttons (10).

When you have finished making your changes,

- ⇒ press the **MENU** button (8) or **OK** (11) twice.

Note:

- The set scantime also applies to scanning in CD and CD changer mode.

Tuner configuration

This unit is equipped with a multiband tuner. The tuner can be configured to suit the requirements that are specific to various countries. The countries/regions available are: America, Europe, Asia and Thailand. The tuner will only function optimally if it is configured for the country/region in which the unit is being operated.

Configuring the tuner

- ⇒ Press the **MENU** button (8).
- ⇒ Keep pressing the **∨** or **∧** button (10) until "FM TUNER" appears in the display.

- ⇒ Press the < or > button (10) to set the country/region.

When you have finished making your changes,

- ⇒ press the **MENU** button (8) or **OK** (11) twice.

Note:

- Once you have configured the tuner, the unit will switch to radio mode and tune into the preset frequency 87.5 MHz

Setting the display

In radio mode, you have the option of continuously displaying the time or continuously displaying the frequency.

- ⇒ Keep the **DIS** button (7) pressed until the required display appears.

CD mode

You can use this unit to play standard CDs with a diameter of 5 inches.

 Risk of damage to the CD drive! CD singles with a diameter of 3 inches and contoured CDs (shape CDs) are not suitable for playback in this unit.

We accept no liability for any damage to the CD drive that may occur as a result of the use of unsuitable CDs.

Switching to CD mode

- If there is no CD inserted in the drive,

- ⇒ press the **CD** button (9).

The flip-release panel opens.

- ⇒ Gently insert the CD with the printed side uppermost into the drive until you feel some resistance.

The CD is drawn into the drive automatically.

You must not hinder or assist the drive as it draws in the CD.

- ⇒ Gently close the control panel whilst exerting a little pressure until you feel it click into place.

CD playback begins.

- If a CD is already inserted in the drive.

- ⇒ Keep pressing the **CD•C** button (16) until "CD" appears in the display.

Playback begins from the point at which it was last interrupted.

CD MODE

Selecting tracks

⇨ Press one of the arrow buttons (10) to select the next or previous track.

If you press the **V** or **<** button (10) once, the current track will be played again from the beginning.

Quick track selection

To quickly select tracks backwards or forwards,

⇨ keep one of the **V** or **⏮** buttons (10) pressed until fast-reverse / fast-forward track selection begins.

Fast searching (audible)

To fast search backwards or forwards,

⇨ keep one of the **<>** buttons (10) pressed until fast reversing / fast forwarding begins.

Random play (MIX)

⇨ Press button **5 MIX** (14).

“MIX CD” appears briefly in the display and the MIX symbol lights up. The next randomly selected track will then be played.

Stopping MIX

⇨ Press button **5 MIX** (14) again.

“MIX OFF” appears briefly in the display and the MIX symbol disappears.

Scanning tracks (SCAN)

You can briefly play all the tracks on a CD.

⇨ Press the **OK** button (11) for longer than two seconds. The next track will then be played briefly.

Note:

- You can set the scantime. For further details, please read the section entitled “Setting the scantime” in the “Radio mode” chapter.

Stopping SCAN and continuing playback

⇨ To stop scanning, press the **OK** button (11).

The current track will then continue to be played.

Repeating tracks (REPEAT)

⇨ If you want to repeat a track, press button **4 RPT** (14).

“REPEAT TRCK” appears briefly in the display and the RPT symbol lights up. The track is repeated until you deactivate RPT.

Cancelling repeat

⇨ If you want to stop the repeat function, press button **4 RPT** (14) again.

“REPEAT OFF” appears briefly in the display and the RPT symbol disappears. Normal playback is then continued.

Pausing playback (PAUSE)

⇨ Press button **3** (14).

“PAUSE” appears in the display.

Cancelling pause

⇨ Press button **3** (14) while in pause mode.

Playback is continued.

Changing the display

- ⇒ To switch between the track number and clock display / track number and playing time display, press the **⏸ / DIS** button (7) once or several times for longer than two seconds until the required display appears.

Ejecting a CD

- ⇒ Press the **⏸** button (9).

The flip-release panel opens and the CD is ejected.

- ⇒ Remove the CD and close the control panel.

CD changer mode

Note:

- Information on handling CDs, inserting CDs and operating the CD changer can be found in the operating instructions supplied with your CD changer.

Switching to CD changer mode

- ⇒ Keep pressing the **CD•C** button (16) until “CHANGER” appears in the display.

Playback begins with the first CD that the CD changer detects.

Selecting a CD

- ⇒ To move up/down from one CD to another, press the **⏮** or **⏭** button (10) once or several times.

Selecting tracks

- ⇒ To move up/down from one track to another on the current CD, press the **>** or **<** button (10) once or several times.

Quick track selection

To quickly select tracks backwards or forwards,

- ⇒ keep one of the **⏮** or **⏭** buttons (10) pressed until fast-reverse / fast-forward track selection begins.

Fast searching (audible)

To fast search backwards or forwards,

- ⇒ keep one of the **<>** buttons (10) pressed until fast reversing / fast forwarding begins.

CD CHANGER MODE

Changing the display

- ⇨ To switch between the track number and clock display / track number and playing time display / CD number and track number display, press the **⏪ / DIS** button (7) once or several times for longer than two seconds until the required display appears.

Repeating individual tracks or whole CDs (REPEAT)

- ⇨ If you wish to repeat the current track, briefly press button **4 RPT** (14).

“REPEAT TRCK” appears briefly and RPT lights up in the display.

- ⇨ If you wish to repeat the current CD, press button **4 RPT** (14) again.

“REPEAT DISC” appears briefly and RPT lights up in the display.

Cancelling repeat

- ⇨ If you want to stop the repeat function for the current track or CD, press button **4 RPT** (14) until “REPEAT OFF” appears briefly in the display and RPT disappears.

Random play (MIX)

- ⇨ To play all the tracks on the current CD in random order, briefly press button **5 MIX** (14).

“MIX CD” appears briefly and MIX lights up in the display.

- ⇨ To play the tracks on all the inserted CDs in random order, press button **5 MIX** (14) again.

“MIX ALL” appears briefly and MIX lights up in the display.

Note:

- In the case of the CDC A 08 and the IDC A 09, all the CDs in the changer are selected randomly. In the case of any other changer, all the tracks on one CD are played randomly before the next CD in the changer is played.

Stopping MIX

- ⇨ Press button **5 MIX** (14) until “MIX OFF” appears briefly in the display and MIX disappears.

Scanning all tracks on all CDs (SCAN)

- ⇨ To briefly play all the tracks on all inserted CDs in ascending order, press the **OK** button (11) for longer than two seconds.

“SCAN” appears in the display.

Stopping SCAN

- ⇨ To stop scanning, briefly press the **OK** button (11).

The current track will then continue to be played.

Note:

- You can set the scantime. For further details, please read the section entitled “Setting the scantime” in the “Radio mode” chapter.

Pausing playback (PAUSE)

⇨ Press button **3**  (14).

“PAUSE” appears in the display.

Cancelling pause

⇨ Press button **3**  (14) while in pause mode.

Playback is continued.

CLOCK - Time

Briefly displaying the time

⇨ To display the time, briefly press the  / **DIS** button (7).

Setting the time

Setting the time manually

⇨ To set the time, press the **MENU** button (8).

⇨ Keep pressing the **↵** or **↶** button (10) until “CLOCKSET” appears in the display.

⇨ Press the **>** button (10).

The time appears in the display. The minutes flash on and off and can be adjusted.

⇨ Adjust the minutes using the **↶↵** buttons (10).

⇨ Once you have set the minutes, press the **<** button (10). The hours start flashing.

⇨ Adjust the hours using the **↶↵** buttons (10).

⇨ Press the **MENU** button (8) or **OK** (11) twice.

CLOCK - TIME

Selecting 12/24-hour clock mode

- ⇒ Press the **MENU** button (8).
“MENU” appears in the display.
- ⇒ Keep pressing the **√** or **⌫** button (10) until “24 H MODE” or “12 H MODE” appears in the display.
- ⇒ Press the **<** or **>** button (10) to switch between the modes.

When you have finished making your changes,

- ⇒ press the **MENU** button (8) or **OK** (11).

Displaying the time continuously when the unit is off and the ignition is on

To display the time when the unit is off and the vehicle ignition is on,

- ⇒ press the **MENU** button (8).
- ⇒ Keep pressing the **√** or **⌫** button (10) until “CLK DISP OFF” or “CLK DISP ON” appears in the display.
- ⇒ Press the **<** or **>** button (10) to switch between the ON/OFF settings.

When you have finished making your changes,

- ⇒ press the **MENU** button (8) or **OK** (11).

Briefly displaying the time when the unit is switched off

To briefly display the time when the unit is off,

- ⇒ press the **⊖ / DIS** button (7).

The time is displayed for eight seconds.

Sound and volume distribution settings

You can adjust the sound and volume distribution settings separately for each source (radio, CD, CD changer and AUX).

Adjusting the bass settings

⇒ Press the **AUDIO** button (13).

“BASS” appears in the display.

⇒ Press the **∨** or **∧** button (10) to adjust the bass.

When you have finished making your changes,

⇒ press the **AUDIO** button (13).

Adjusting the treble settings

⇒ Press the **AUDIO** button (13).

“BASS” appears in the display.

⇒ Keep pressing the **>** button (10) until “TREBLE” appears in the display.

⇒ Press the **∨** or **∧** button (10) to adjust the treble.

When you have finished making your changes,

⇒ press the **AUDIO** button (13).

Setting the left/right volume distribution (balance)

⇒ To set the left/right volume distribution (balance), press the **AUDIO** button (13).

“BASS” appears in the display.

⇒ Keep pressing the **>** button (10) until “BALANCE” appears in the display.

⇒ Press the **∨** or **∧** button (10) to adjust the balance (right/left).

When you have finished making your changes,

⇒ press the **AUDIO** button (13).

Setting the front/back volume distribution (fader)

⇒ To set the front/back volume distribution (fader), press the **AUDIO** button (13).

“BASS” appears in the display.

⇒ Keep pressing the **>** button (10) until “FADER” appears in the display.

⇒ Press the **∨** or **∧** button (10) to adjust the fader (front/back).

When you have finished making your changes,

⇒ press the **AUDIO** button (13).

X-BASS

The X-BASS feature can be used to boost the bass at low volume levels.

Adjusting the X-BASS boost settings

The X-BASS boost can be set in steps from "X-BASS LOW" to "X-BASS MID" to "X-BASS HIGH".

- ⇒ Press the **X-BASS** button (12).
- ⇒ Keep pressing the **<** or **>** button (10) until the required setting appears in the display.

When you have finished making your changes,

- ⇒ press the **X-BASS** button (12).

Setting the spectrometer

The spectrometer (level display) briefly provides a symbolic display of the volume and the audio control settings whilst you are adjusting them.

When you are not changing any settings, the spectrometer displays the car radio's output level.

You can set the type of spectrometer in the menu.

There are two types available.

Setting the spectrometer type

- ⇒ Press the **MENU** button (8).
"MENU" appears in the display.
- ⇒ Keep pressing the **∨** or **∧** button (10) until "EQ DISPLAY" appears in the display.
- ⇒ Press the **<** or **>** button (10) to select "SPECTRUM 1", "SPECTRUM 2" or "EQ DISP OFF."

When you have finished making your changes,

- ⇒ press the **MENU** button (8) or **OK** (11) twice.

External audio sources

Instead of connecting a CD changer, you can connect another audio source equipped with a line output. The audio source, for example, can be a portable CD player, MiniDisc player or MP3 player.

The AUX input must be activated in the menu.

If you want to connect an external audio source, you will need an adapter cable. You can obtain this adapter cable (BP no.: 7 607 897 093) from your authorised Blaupunkt dealer.

Switching the AUX input on/off

⇒ Press the **MENU** button (8).

“MENU” appears in the display.

⇒ Keep pressing the **↵** or **↶** button (10) until “AUX-IN-1 OFF” or “AUX-IN-1 ON” appears in the display.

⇒ Press the **<** or **>** button (10) to switch AUX on/off.

When you have finished making your changes,

⇒ press the **MENU** button (8) or **OK** (11).

Note:

- If the AUX input is switched on it can be selected by pressing the **CD•C** button (16).

Specifications

Amplifier

Output power: 4 x 25 watts sine in accordance with DIN 45 324 at 14.4 V
4 x 50 watts max. power

Tuner

Frequency ranges US:

FM: 87.5 – 107.9 MHz
AM: 530 – 1710 kHz

Frequency ranges Asia and Europe:

FM: 87.5 – 108 MHz
AM: 531 – 1602 kHz

Frequency ranges Thailand:

FM: 87.5 – 108 MHz
AM: 531 – 1629 kHz

FM mono sensitivity:

17 dbf

FM frequency response:

35 - 16,000 Hz

CD

Frequency response:

20 - 20,000 Hz

Pre-amp out

4 channels: 3 V

Input sensitivity

AUX input: 2 V / 6 kΩ
Tel./Navi input: 10 V / 1 kΩ

Subject to changes!

GUARANTEE

Guarantee

The scope of the guarantee is orientated around the regulations in force within the country in which the unit was purchased.

If your unit develops a fault, please contact your dealer and present the purchase receipt.

If the statutory guarantee period in your country is less than 12 months, Blaupunkt will grant a 12-month manufacturer's guarantee. This guarantee does not cover damage due to wear, incorrect usage or commercial use.

If you wish to enforce a claim under the manufacturer's guarantee that is provided by Blaupunkt, please send the faulty unit together with the purchase receipt to the Blaupunkt customer service centre in your country. You can find out which address is closest to you by contacting the telephone hotline listed on the back page of this booklet. Blaupunkt retains the right to rectify defects or supply a replacement.

Installation instructions • Notice de montage • Instrucciones de instalación • Instruções de montagem

Safety instructions

When carrying out installation work and making connections please observe the following safety instructions:

- Disconnect the negative terminal of the battery! When doing so, please observe the vehicle manufacturer's safety instructions.
- Make sure you do not damage vehicle components when drilling any holes.
- The cross sections of the positive and negative cables must not be less than 1.5 mm².
- **Do not connect the vehicle's plug connectors to the radio!**
- You can obtain the adapter cable required for your vehicle type from any BLAUPUNKT dealer.
- Depending on the model, your vehicle may differ from the description provided here. We accept no responsibility for any damages due to incorrect installation or connection or for any consequential damages. If the information provided here is not suitable for your specific installation requirements, please contact your Blaupunkt dealer, your vehicle manufacturer or our telephone hotline.

Consignes de sécurité

Respecter les consignes de sécurité suivantes pendant la durée du montage et du branchement.

- Débrancher le pôle (-) de la batterie ! Respecter les consignes de sécurité du constructeur automobile !
- Veiller à n'endommager aucune pièce du véhicule en perçant des trous.
- La section du câble (+) et (-) ne doit pas dépasser 1,5 mm².
- **Ne pas brancher les connecteurs du véhicule sur la radio !**
- Les câbles d'adaptation nécessaires pour le type de véhicule sont disponibles auprès des revendeurs BLAUPUNKT.
- En fonction du modèle, votre véhicule peut différer de cette description. Nous déclinons toute responsabilité en cas de dommages causés par des erreurs de montage ou de connexion et en cas de dommages consécutifs. Si les indications décrites ici ne s'appliquent au montage que vous voulez effectuer, adressez-vous à votre revendeur Blaupunkt, votre constructeur automobile ou notre service d'assistance téléphonique.

Supplied Mounting Hardware
Materiel de montage fourni
Ferreteria de montaje
suministrada
Elementos de fixação fornecidos.

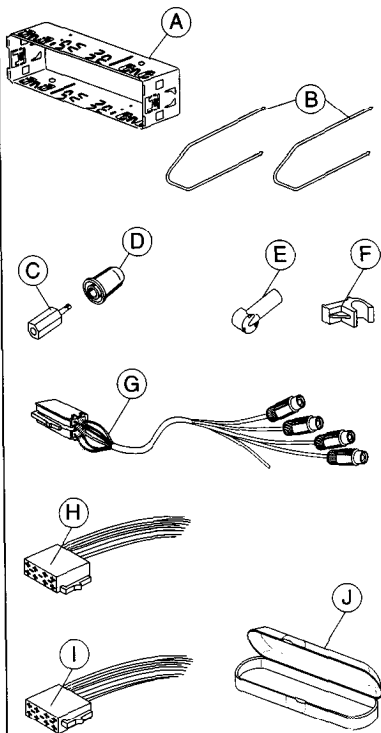

1.

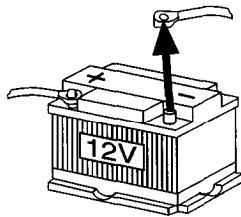

2.

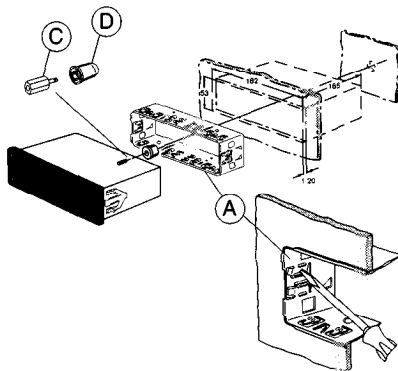

3.

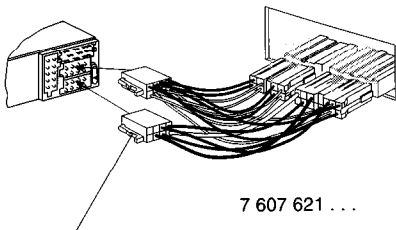

Car-specific adapter cable which is available at your dealer.

Câble adaptateur spécifique au véhicule, disponible dans le commerce.

Adaptador específico del vehículo, el cual se puede adquirir en el comercio especializado.

Cabo de adaptação específico do automóvel que pode ser adquirido no comércio especializado.

4.

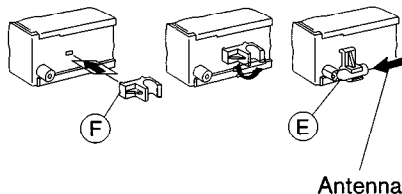

5.

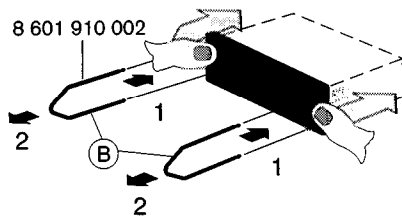

6.

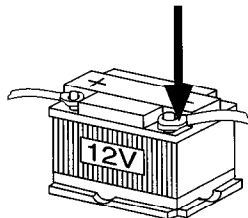

7.

C-1 C-2 C-3

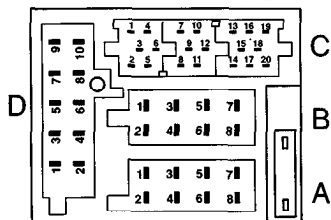

A		B	
1	nc	1	Speaker out RR+
2	Radio Mute	2	Speaker out RR-
3	nc	3	Speaker out RF+
4	Permanent +12V	4	Speaker out RF-
5	Aut. antenna	5	Speaker out LF+
6	Illumination	6	Speaker out LF-
7	Kl.15/Ignition	7	Speaker out LR+
8	Ground	8	Speaker out LR-

D	
1	nc
2	nc
3	nc
4	nc
5	nc
6	nc
7	nc
8	nc
9	nc
10	nc

C					
C1		C2		C3	
1	Line Out LR	7	Telefon / Navi NF in +	13	Bus - In
2	Line Out RR	8	Telefon / Navi NF in -	14	Bus - Out
3	Line Out Masse / Ground	9	Radio / Navi Mute	15	Permanent +12V
4	Line Out LF	10	⚡ FB +12V / RC +12V	16	⚡ +12V
5	Line Out RF	11	Fernbedienung / Remote Control	17	Bus - Masse / GND
6	⚡ +12V Amplifier	12	FB - Masse / RC - GND	18	AF - Masse / GND
				19	Line In - L
				20	Line In - R

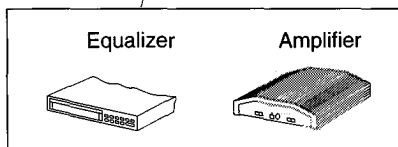

Remote Control

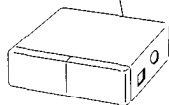

CD-Changer

8.

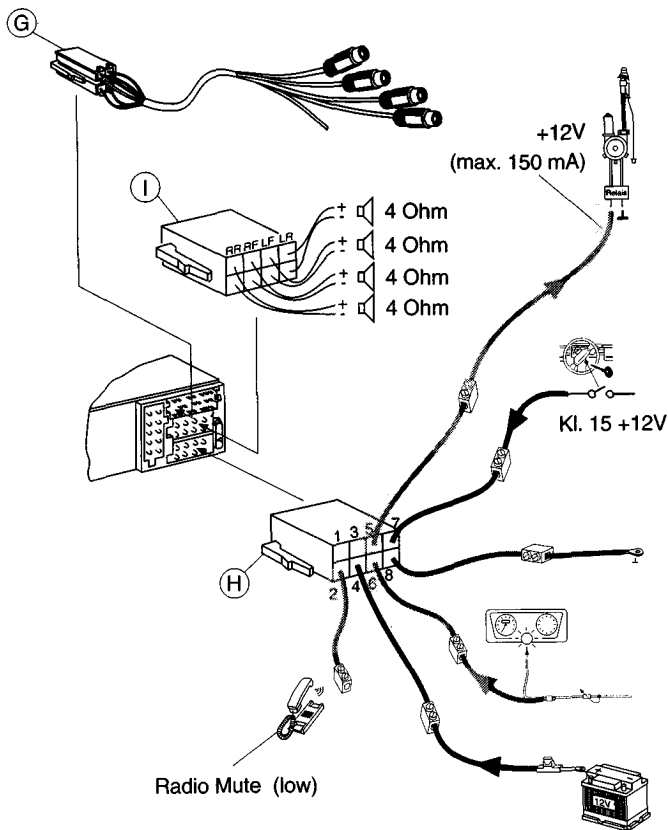

This information is subject to change without notice!

Sous réserve de modifications!

Modificaciones reservadas!

Sob reserva de alterações!

Service numbers / Numéros du service après-vente / Números de servicio / Número de serviço

Tel.:

Fax:

Deutschland	0 18 05 00 02 25	0 51 21 49 40 02
Belgique / België	02.525.54.44	02.525.54.48
France	014 010 70 07	014 010 73 20
Nederland	023 565 63 48	023 565 63 31
Great Britain	018 958 383 66	018 958 383 94
Ireland	(01) 4149400	(01) 4598830
Danmark	44 89 83 60	44 89 86 44
Sverige	08 750 15 00	08 750 18 10
Norge	66 81 70 00	66 81 71 57
Suomi	094 359 91	094 359 92 36
Österreich	01 610 39 0	01 610 39 391
Ελλάς	015 762 241	015 769 473
Česká republika	026 130 04 41	026 130 05 14
USA	800-266 25 28	708-681 71 88
Singapore	006 535 054 47	006 535 053 12
Slovensko	042 175 873 212	042 175 873 229

Blaupunkt GmbH

Limited Warranty (United States)

Robert Bosch Corporation warrants new Blaupunkt car audio products it distributes in the United States through authorized Blaupunkt dealers, or which are imported as original vehicle equipment by the automobile manufacturer, to be free from defects in material and workmanship, in accordance with the following:

For twelve (12) months after delivery to you, the original consumer purchaser, we will repair or at our option replace at no charge to you any car audio product which, under normal conditions of use and service, proves to be defective in materials or workmanship. However, this warranty does not cover expenses incurred in the removal or reinstallation of any car audio product, whether or not proven defective, and does not cover products not purchased from an authorized Blaupunkt dealer. This warranty is limited to the original consumer purchaser and is not transferable. Repaired and replacement car audio products shall assume the identity of the original for purpose of this warranty and this warranty shall not be extended with respect to such products.

To obtain performance of this warranty, contact the nearest Blaupunkt authorized repair facility or our nearest office. A dated purchase receipt or other proof that the product is within the warranty period will be required in order to honor your claim. Carefully pack the unit and ship prepaid to the servicing location. For further information, write to the Robert Bosch Corporation, 2800 South 25th Avenue, Broadview, Illinois, 60153, attention Blaupunkt Customer Service Department or call 1-800-266-2528.

Specifically excluded from this warranty are failures caused by misuse, neglect, abuse, improper operation or installation, dropping or damaging a radio faceplate, unauthorized service or parts, or failure to follow maintenance instructions or perform normal maintenance activities. Normal maintenance activities for car audio products include but are not limited to cleaning, such as cleaning radio faceplate connectors and tape heads, tape player head demagnetization and tape player lubrication, compact disc and lens cleaning, and other minor maintenance activities and adjustments that are outlined in the owner's manual or that are normally required for continued proper operation. Also excluded from this warranty is the correction of improper installation and the elimination of any external electromagnetic interference.

This warranty sets forth your exclusive remedies with respect to the products covered by it. We shall not be liable for any incidental, consequential, special or punitive damages arising from the sale or use of any Blaupunkt car audio products, whether such claim is in contract or tort. No attempt to alter, modify, or amend this warranty shall be effective unless authorized in writing by an officer of Robert Bosch Corporation.

THIS WARRANTY IS IN LIEU OF ALL OTHER WARRANTIES OR REPRESENTATIONS, EXPRESS OR IMPLIED, INCLUDING ANY WARRANTY IMPLIED BY LAW, WHETHER FOR MERCHANTABILITY OR FITNESS FOR A PARTICULAR PURPOSE OR OTHERWISE AND SHALL BE EFFECTIVE ONLY FOR THE PERIOD THAT THIS EXPRESS WARRANTY IS EFFECTIVE.

In the event any provision, or any part or portion of this warranty shall be held invalid, void or otherwise unenforceable, such holding shall not affect the remaining part or portions of that provision or any other provision hereof.

NOTICE TO CALIFORNIA OWNERS

If your Blaupunkt car audio product needs warranty repair service and there is no authorized service center reasonably close to you, you can return the defective unit to the dealer from whom you purchased it, or you can return it to any dealer who sells Blaupunkt car audio products. The dealer may, at the dealer's option, replace, repair or refund the purchase price for any Blaupunkt car audio products which prove defective under conditions of normal use. If the dealer fails to repair, replace, or partially refund your money, you may take your Blaupunkt car audio product to any repair shop and they can repair your unit at our expense unless the repair cost exceeds the depreciated value of the unit, but you must contact Blaupunkt to receive authorization to do this before your car audio product is repaired.

ROBERT BOSCH CORPORATION
BLAUPUNKT CUSTOMER SERVICE
2800 SOUTH 25TH AVENUE
BROADVIEW, IL 60153
TEL: 1-800-266-2528

BENEFITS REGISTRATION

By completing and returning the attached Benefits Registration Card, you will receive these important benefits:

- ***Insurance Referral*** - We will keep the model number, warranty (serial) number, and date of purchase of your new Blaupunkt radio on file to help you refer to this information in the event of an insurance claim, such as if the car is stolen.
- ***Warranty Confirmation*** - Your prompt registration confirms your rights to the protection available under the terms and conditions of your Blaupunkt warranty.
- ***Ownership Registration*** - Returning this card is your only way to guarantee that you will be notified by Blaupunkt of any issues that arise concerning this product.

 **BLAUPUNKT.**

Bosch Group

IMPORTANT!

Thank You For Buying a ● **BLAUPUNKT. Radio!**

To provide you with these important benefits, you must complete this card and mail within 10 days of purchase.

- ✓ **Insurance Referral**
- ✓ **Warranty Confirmation**
- ✓ **Ownership Registration**

Your responses will also help us refine and enhance our products and marketing programs. We greatly appreciate and value your input, and are pleased to provide you with the above benefits.

Warranty Details - Refer to your radio's warranty. **Service Information** - Please contact us at:

Robert Bosch Corporation Sales Group
Blaupunkt - Mobile Communications Division
2800 S. 25th Ave.
Broadview, IL 60153

1-800-266-2528

1 1. Mr. 2. Mrs. 3. Ms. 4. Miss 174AMIAMI BEACH CD51
BP1270 1 0210073

First Name:

Initial:

Last Name:

Address: (Number and Street)

Apt. #:

City:

State:

Zip:

2 Phone #: _____ 3 Date of Purchase: _____
Month Day Year

4 Store Name: _____

5 Where did you make your purchase?

1. Car audio store 3. Superstore 5. Catalogue/mail order
2. Automobile dealer 4. Department store 6. Other

6 Check the two (2) most important reasons you chose Blaupunkt over the competition:

1. Friend/Family recommendation 6. Styling/Appearance 11. Blaupunkt Reputation
2. Salesperson recommendation 7. Tuner quality/features 12. Detachable Face
3. Tape player quality/features 8. Blaupunkt warranty 13. Magazine review
4. CD player quality/features 9. Convenient installation 14. Value for price
5. Ease of use/location of controls 10. Sound quality 15. Other (Describe in comments)

7 In what vehicle will this Blaupunkt product be installed?

Make: _____ Model: _____ Year: _____
example: Ford example: Mustang example: 1965

8 How did you first learn about Blaupunkt?

1. Friend/relative 5. Radio ad
2. Salesperson 6. Newspaper ad
3. Magazine article 7. Magazine ad
4. In-store display 8. Not sure

15 Including yourself, what is the total number of people living in your household?

_____ (EXAMPLES: 01, 02, 03, 04,....)

9 When did you make your decision on which model to buy?

1. Before coming to the store
2. At the store

16 NOT including yourself, what are the AGES of other people living in your household?

Age (in years)

Male: _____

Female: _____

10 What brand was your second choice?

1. Alpine 6. JVC 11. Sony
2. Audiovox 7. Kenwood 12. Other
3. Clarion 8. Panasonic 13. None
4. Eclipse 9. Pioneer
5. Jensen 10. Rockford-Fosgate

17 Marital Status: 1. Married 2. Single

11 Who installed this product?

1. Store where the product was purchased
2. I did it myself 4. Independent installer
3. Friend or relative 5. Other

18 Which best describes your family income?

1. Under \$15,000 5. \$50,000-\$74,999
2. \$15,000-\$24,999 6. \$75,000-\$99,999
3. \$25,000-\$34,999 7. \$100,000-149,999
4. \$35,000-\$49,999 8. Over \$150,000

12 Which of these products do you plan to buy in the future? (check all that apply)

1. None 4. Amplifier 6. Equalizer
2. Front speakers 5. Subwoofer 7. CD changer speakers
3. Rear speakers

13 Date of Your birth: _____
Month Day Year

14 Education (Please check which category applies):

1. High School 3. Completed College
2. Some College 4. Graduate School

19 In the last six(6) months have you or your spouse:

1. Purchased clothes through the mail?
2. Purchased gifts through the mail?
3. Worked in your garden?
4. Traveled on vacation?
5. Purchased a PC or PC software?
6. Purchased two or more books?
7. Purchased cassettes/CDs?
8. Donated to wildlife/environmental causes?
9. Donated to charities

Comments: _____



Bosch Group

Please send other correspondence to:

Robert Bosch Corporation Sales Group
Blaupunkt - Mobile Communications Division
2800 S. 25th Ave.
Broadview, IL 60153



Please
Place First
Class
Stamp
Here



Bosch Group

**BENEFITS REGISTRATION DEPARTMENT
PO BOX 1265
DENVER CO 80201-1265**

